

Explorer Kit

A preferred kit for STEAM education to get started



USER MANUAL ^{V1.1}

Directory

1. About Crowbits	2
2. Module list in the Explorer Kit	4
3. Know the Crowbits module	4
4. Project tutorial	7
• Minesweeping War	7
• Smart Money Box	14
• Monkey Rock Climbing	21
• Garden Lamp	29
• Crazy Swing Ride	34
• Flexible Clamp	46
• Non-contact Control Car	52
• Smart Fan	58
• Fitness Expert	67
• Quadruped Robot	77
• Lift	86
• Skiing Robot	99
Lego Parts List	106
Common technical problems	108

1. About Crowbits

Crowbits is a new type of STEAM education tool, it integrates traditional circuit modules into a LEGO-compatible block, which means you can build creative projects with our Crowbits and LEGO bricks. Compared with some electronic kits on the market, Crowbits is definitely worthy of “plug and play”, for it doesn't require cables, tools or complex operations to connect them together. The magnetic snap on the side of these blocks allows you to connect these blocks together with the magnet. Learning through playing, Crowbits will transfer the way you learn into a more fun way. We have designed a series of modules for Crowbits, each module can be programmed. According to users' different needs, these modules form three series of kits, respectively no-programming kit, programming kit and application kit. According to the difficulty level, we define these kits as three stages to study electronic and programming.



The first stage-Crowbits no-coding kit includes more than 20 kinds of common sensors and modules, which means you can control all these modules without programming. When combined with carton papers or LEGO bricks, you can complete a creative project quickly. From these projects, kids can improve their hands-on ability, and meanwhile stimulate their imagination and creativity. Besides that, after knowing the logic of how these Crowbits blocks run, it's helpful enough for kids to step into the coding world.

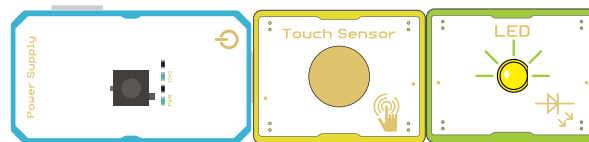

The second stage-Crowbits coding kit contains the basic coding kit and advanced coding kit. These kits support multiple programming platforms, such as micro:bit, Arduino, Raspberry Pi and so on. And equipped with Elecrow's customized visual programming software-Letscode, you can program all Crowbits blocks through drag and drop. In addition, Letscode also supports other programming languages, like Python and Arduino IDE. Combining programming languages with various electronics, Crowbits provides a fun and effective way to learn code and electronics for students.

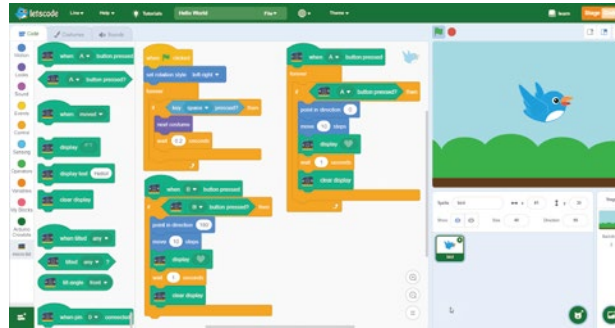

The third stage-Crowbits application kit is more productized. With the no-coding kit, you can learn the basic knowledge of electronics and stimulate your creativity; with the coding kit, you can further discover the joy of electronics and programming.

So based on the application kit, you can even assemble and build a product with complete functionality and appearance, for example game console, mobile phones, and etc. Through these products, you will experience the perfect combination of programming knowledge and complete products.



2. Module list in the Explorer Kit

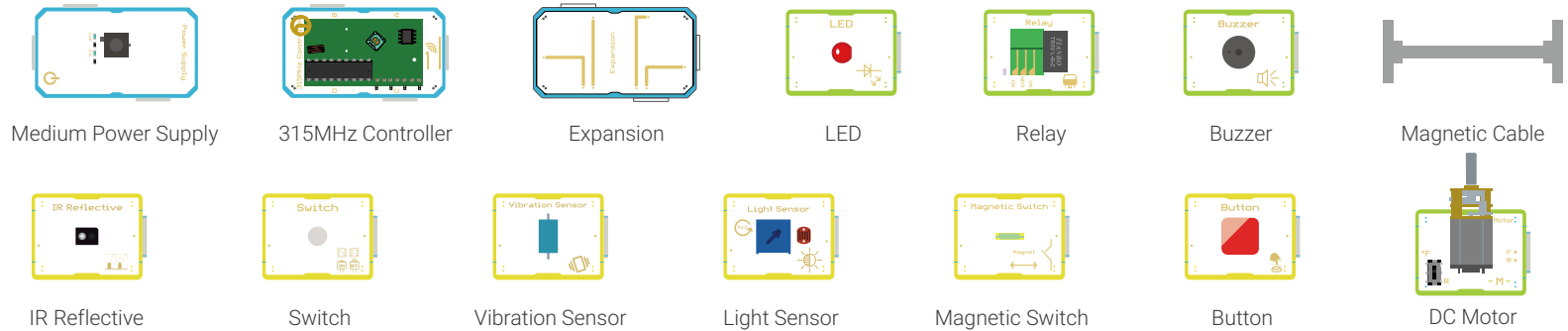

3. Know the Crowbits module

• 1. Structure of Crowbits

TOP

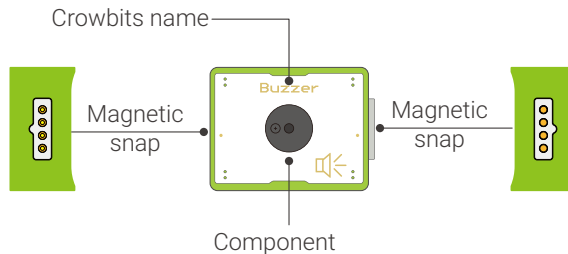

BACK

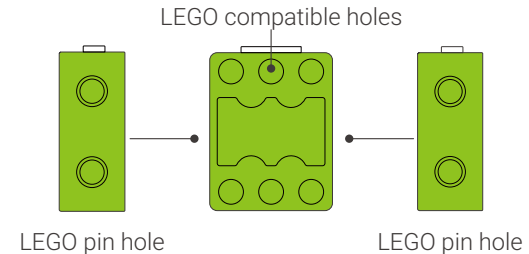

Crowbits name: Crowbits consists of many types of modules, so we marked the name for you to recognize easily.

Sensor: The main component of Crowbits is placed there.

Magnetic snap: It's a magical magnetic pogo-pin, the magnetic snap allows you to connect Crowbits together with magnet.

On the back of Crowbits, we have reserved 6 LEGO compatible holes, it's easy to build creative projects with Crowbits and LEGO bricks together. The LEGO pin hole reserved on the side of Crowbits allows you to fix the module by LEGO pin.

• 2. Color-coded by function

Crowbits modules are divided into four different types, they are color-coded by function.

Power and Logic module (Blue)

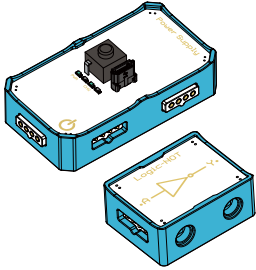

The power module is the power supply of all Crowbits modules, it can provide power supply for other modules. The logic module is used to do some basic logic operations.

Input module (Yellow)

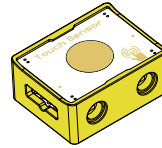

The input module accepts an input from you or the environment and then sends signals to affect the output module.

Output module (Green)

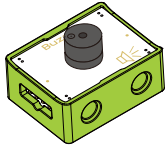

The output modules will do some operations, such as light up, vibrate when they receive a signal from input module.

Special modules(Orange)

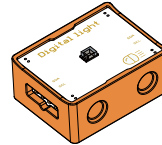

For some special modules (the interface is I2C or UART), we set the color to orange.

• 3. Magnet connection

Connection mode

There are two ways for you to connect Crowbits together, it's easy to connect Crowbits together by snapping them by magnet. Or you could also connect them by magnetic cable.

Connect by magnetic snap

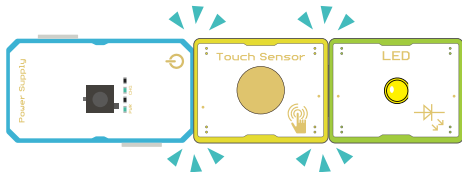

Connect by magnetic cable



Connection rules

A. A complete project must consist of power, input module and output module. The power supply module can be placed at will, whether on the left, on the right, or on the middle of input and output module. Make sure the name of module is facing up when connected.

Pair of power+input+single output



B. The sequence is important, Green is always on the right side of yellow, which means output modules must come after input modules.

C. Input module can affect single output module or multiple output modules at the same time.

Input with single output

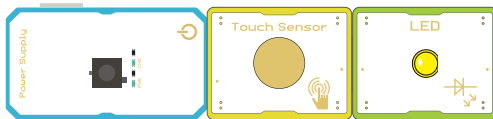

Input with multiple outputs

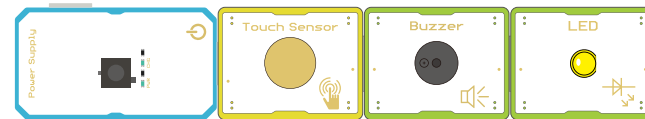

D. We can also connect these modules in a complex way, each input module individually controls a single output module. Remember that the output module is only controlled by the nearest input module on the left.

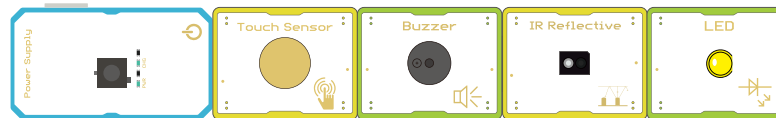

Project tutorial

Minesweeping War

1. Learning Goals:

1. Learn how to use the electronic blocks of the Crowbits
2. Know the basic knowledge of how minesweeping device works
3. Master how to install a minesweeping device

2. Supplies List:

• Electronic supplies:

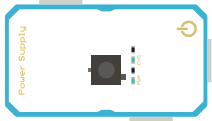

Medium Power Supply

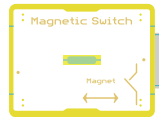

Magnetic Switch

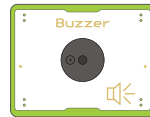

Buzzer

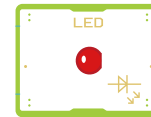

LED



Magnetic Cable

• Structure Supplies:

Minesweeping Paper

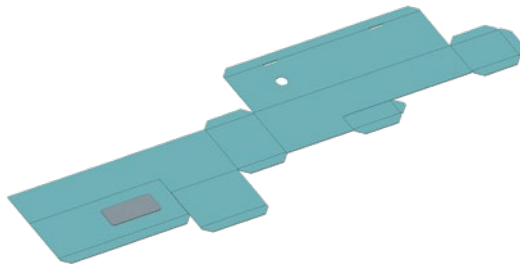

Clip



Magnet



3. Application

In the movie Sweepers, the minesweeper hero Chris often needs to perform minesweeping tasks. As we all know, minesweeping is a very dangerous job, and you will lose your life if you don't pay attention. Therefore, mastering the skill of using minesweeping equipment is particularly important.

Do you know the basic knowledge of how Minesweeper works? It turns out that when the mine detector detects a mine, it will display a reminder signal on the dashboard and sound a "beep..." alarm, so that Chris can locate the location of the mine accurately! Next, let's simulate making a fun minesweeping device!



4. Knowledge Analysis

1. Modules Introduction :

- **Power Supply (Medium Size):** It's a rechargeable power module, and the USB cable can be connected with phone adapter or PC USB port for charging. It's charging with the red light on, fully charged with red light off.

Power Switch: Press to power on with red light on, press again to power off with red light off.

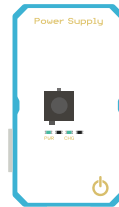

- **Magnetic Switch:** It is a digital input module, which controls the on and off of the circuit through the strength of the magnetic field. It's usually used to detect the magnetic field.

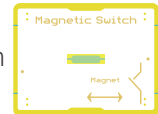

- **LED:** It is a digital output module. The LED light is on when the electrical signal is received, usually used as reminder light.



- **Buzzer:** It is a digital output module, when it receives an electrical signal, it emits a sound, usually used for prompts and alarms.

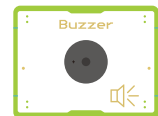

2. Circuit Connection: The simulating minesweeping device is consisted of the medium power module, a buzzer, an LED (red) and a magnetic switch. Connect them according to the following circuit diagram:

3. How Circuit works: The magnetic switch (simulating a minesweeper) functions as a switch. When it is close to the magnet (simulating mine), it will turn on the circuit to make the red LED light and the buzzer alarm. When it is far away from the magnet, the circuit is closed.

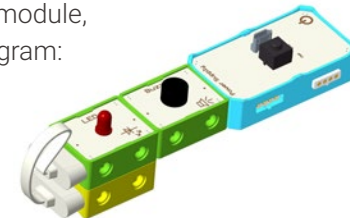

5. Model Building

1. Build the minesweeping map

1. Paste the double-sided tape on the corresponding position in the picture

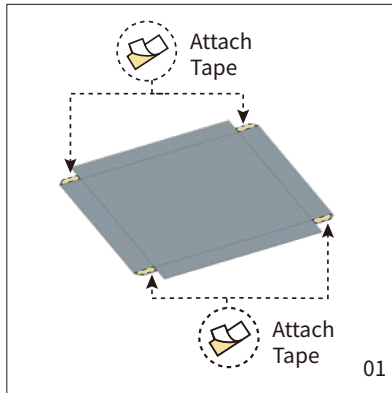

2. Fold and turn the paper model 90 degrees as shown

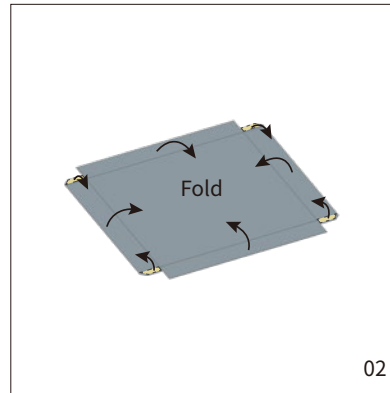

3. Paste and fix the folded map

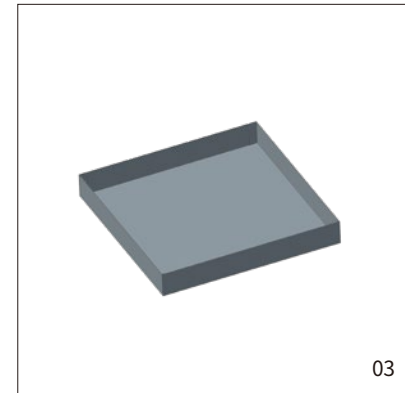

4. Paste and fix the magnet at the corresponding position in the above picture

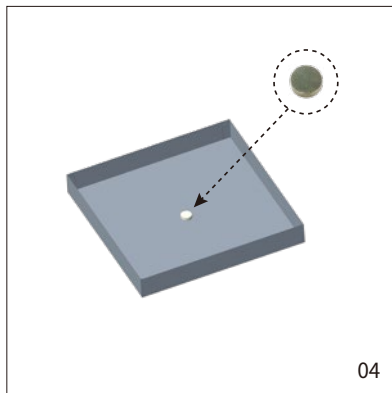

5. Fold and turn the fixed paper mold 180 degrees

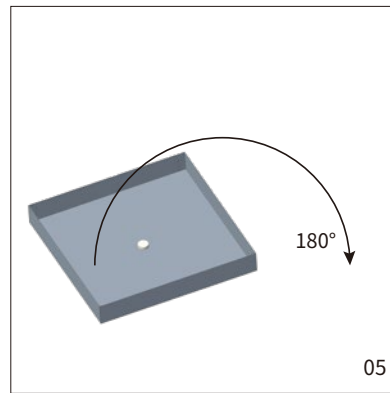

6. Done as shown

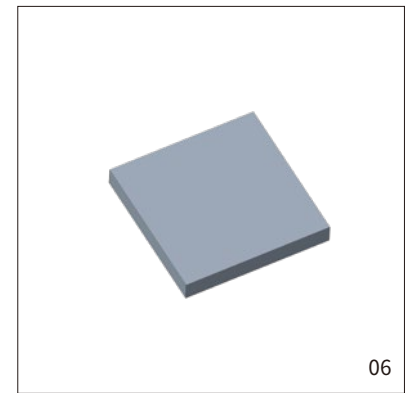

2. Build Minesweeper

1. Unfold the paper model and fold as shown

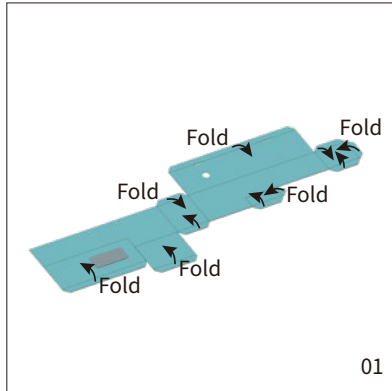

2. Fold and turn the paper model 90 degrees as shown

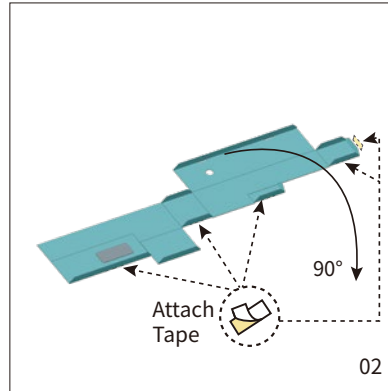

3. Turn the paper model 45 degrees to the right

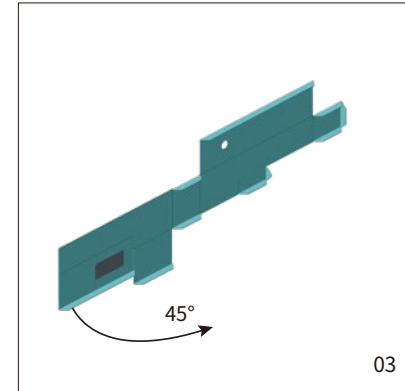

4. Fold as shown

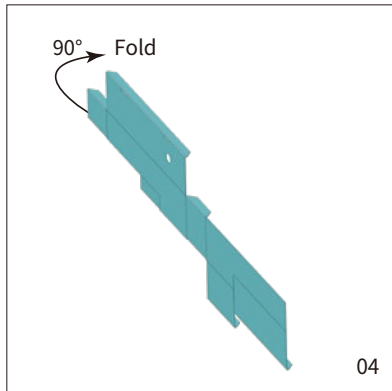

5. Fold as shown

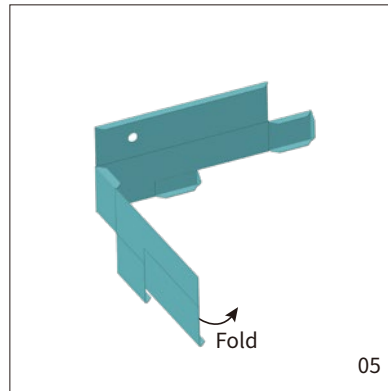

6. Fold the paper model then fix it with double-sided tape as the picture shows

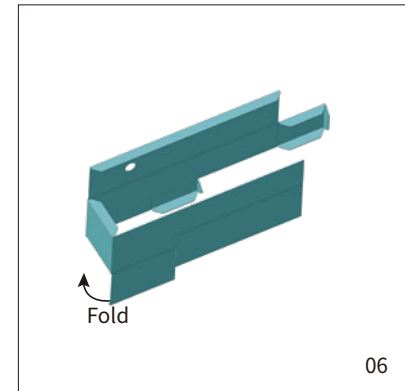

7. Fold as the picture shows then fix it with double-sided tape

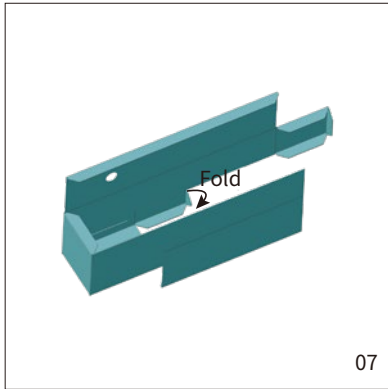

8. Fold as the picture shows then fix it with double-sided tape

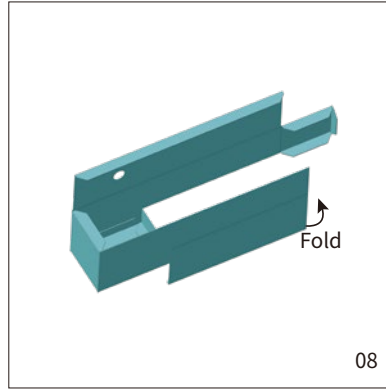

9. Fold the paper model as the picture shows then fixed it with double-sided tape

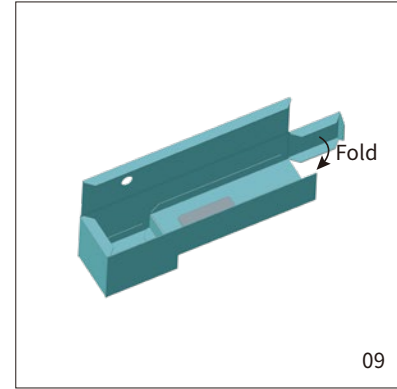

10. Fold the paper model

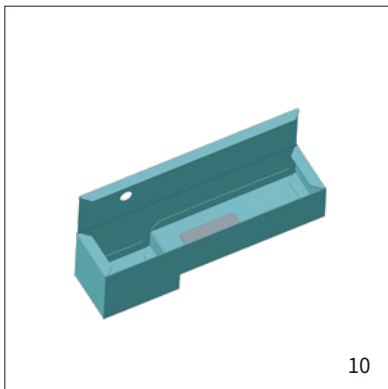

11. Adsorb the magnetic switch under the LED light in reverse

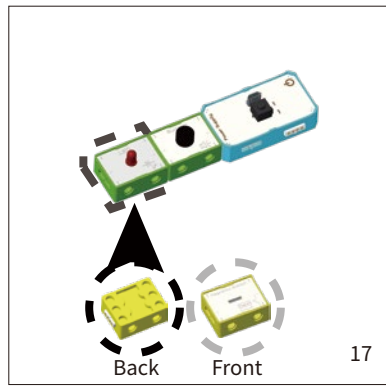

12. Done as shown

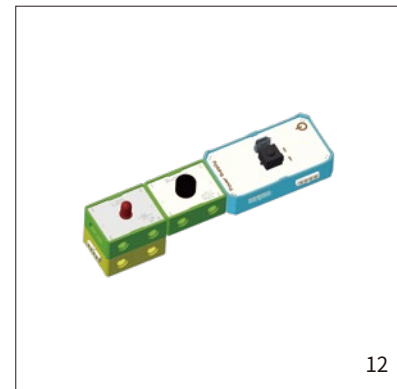

13. Connect the magnetic switch and the LED with a magnetic cable

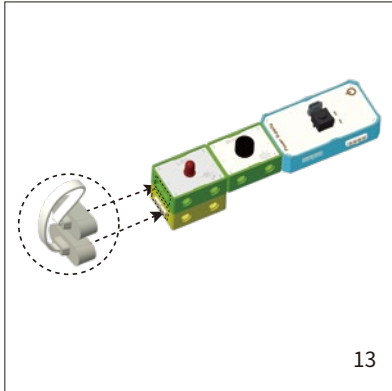

14. Connected Circuit as shown

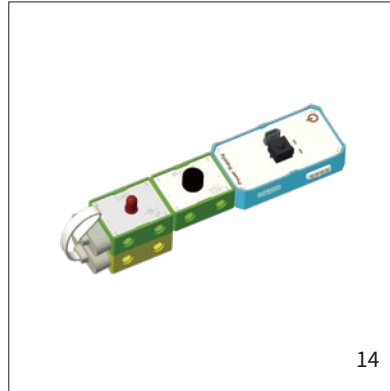

15. Place the connected circuit in the paper model

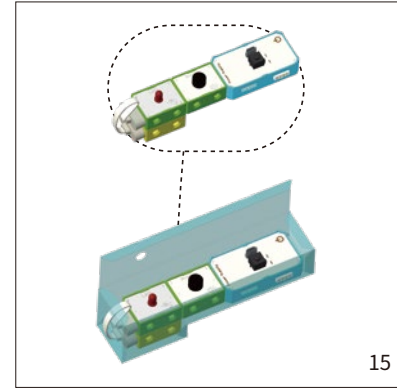

16. Fold as shown

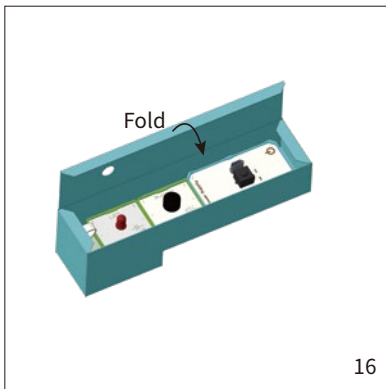

17. Fix the folded paper mold with a clip

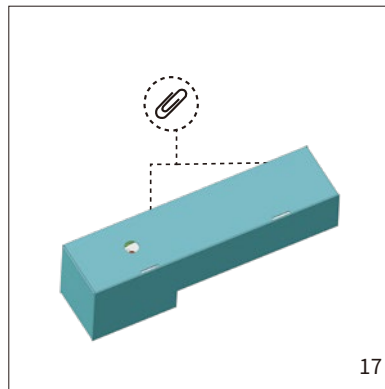

18. Finished

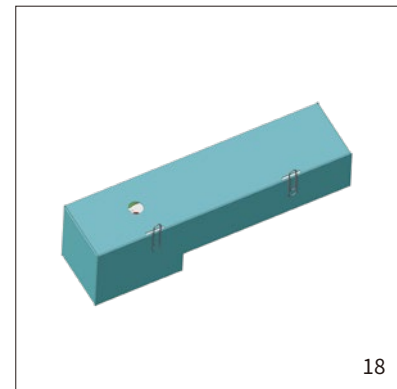

6. Game Interactions

Invite your families and friends to play together!

• Game Rules:

The host is responsible for burying the mines, and be careful not to let other players see it. Other players (more than 2 people) are responsible for guessing the location of the mines. The host uses the minesweeper to inspect the mines and see who is lucky enough to avoid the mines and be the final winner!

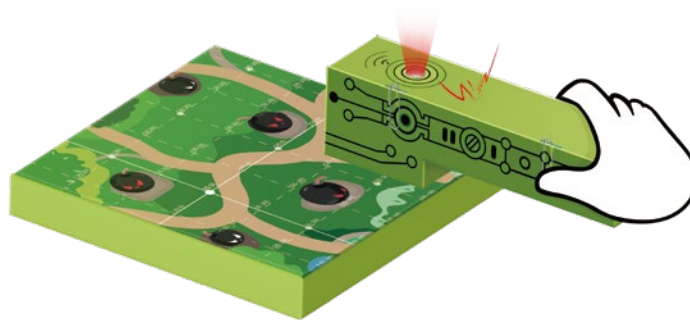

You can also use other small magnets at home to design more mines!

7. Brainstorming

This project is aimed to let you learn the magnetic sensors, also called reed pipes. In fact, there are many applications of magnetic sensors in life:

1. The notebook computer uses a magnetic reed switch, when the lid is closed, the notebook computer is set to sleep/hibernation mode;
2. Liquidometer, door sensor. Install the reed pipes on the door, and you can use it as an alarming device when the door is opened. You can also try designing an anti-theft system. When the door and window are opened, the magnetic sensor touches the magnet sheet, the circuit is turned on, and the alarm is triggered!

Smart Money Box

1. Learning Goals:

1. Learn the basic knowledge of how money box works
2. Master how to install a money box device

2. Supplies List:

• Electronic supplies:

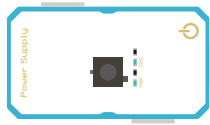

Medium Power Supply



IR Reflective Sensor

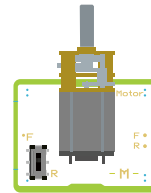

DC Motor



Magnetic Cable

• Structure Supplies:

Smart Money Box Paper Model x2

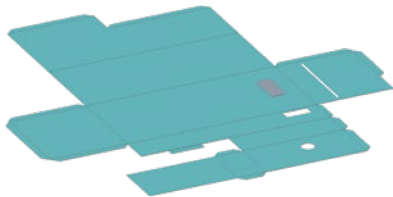

Clip



Wheels



3. Application

Nowadays, parents often give us some pocket money. So how will you keep the pocket money? I think it would be perfect if you have your own money box at this moment.

Do you know how the smart money box works? The money box is a "only in but not out" device. When you put the banknotes at the inlet, it will automatically suck in your banknotes! Next, let's make a smart money box!



4. Knowledge Analysis

1. Modules Introduction :

• **IR Reflective Sensor:** It's a digital input module and emits infrared light when it is powered on. It's sure that infrared light is invisible light. When there is an obstacle in the front, the infrared light will be reflected back. So we can know whether there is a non-black obstacle in front by checking whether the infrared is reflected. The effective distance is between 1 and 3cm.



• **DC motor:** It's a digital output module, which can convert electrical energy into mechanical energy to drive the load to work. There is a toggle switch on the module, which can be used to control forward or backward. Therefore, you can choose the rotation direction of the motor according to the actual situation of the project.

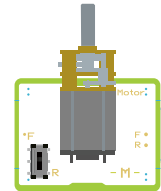

2. Circuit Connection: The smart money box project is consisted of a medium power module, a IR reflective sensor, a DC motor. Connect them according to the following circuit diagram:

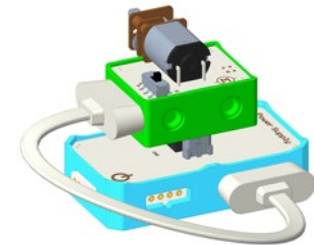

3. How Circuit works: The IR reflective sensor functions as a switch. When it is covered by the banknotes, the generator is driven to rotate. Then the wheels on the motor roll the banknotes into the money box. When the banknotes are completely rolled in (without covering the IR Reflective sensor), the motor will stop rotating.

5. Model Building

1. Build the minesweeping map

1. Fold it as the picture shows

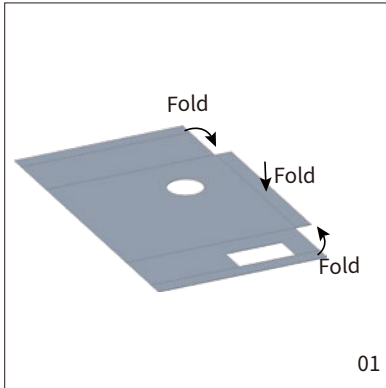

2. Fold it as the picture shows

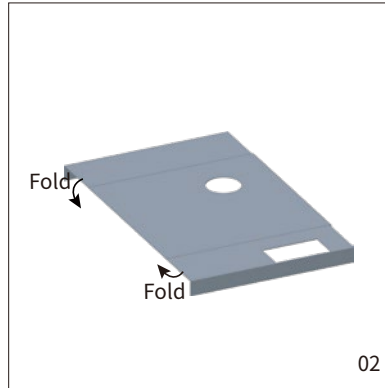

3. The finished motor base should be like this

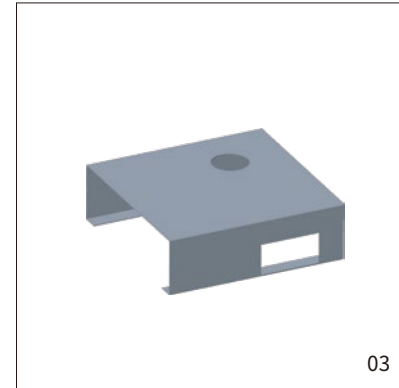

2. Build the saving pot carton

1. Unfold the paper model and fold it as the picture shows

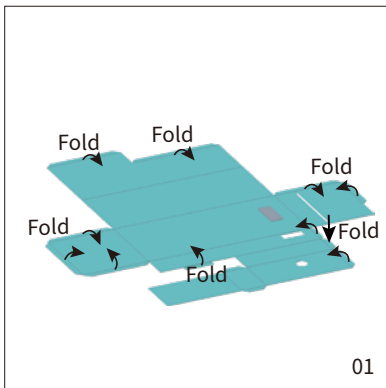

2. Fold it as the picture shows

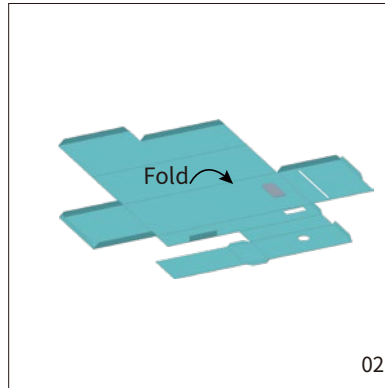

3. Fold it as the picture shows and paste it with double-sided tape

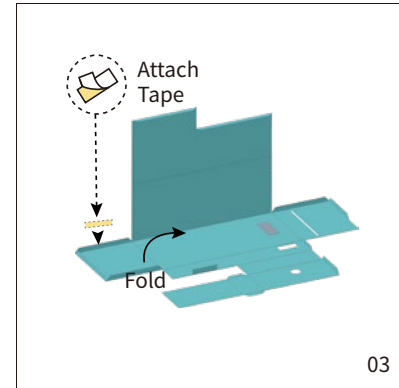

4. Fold it as the picture shows and paste it with double-sided tape

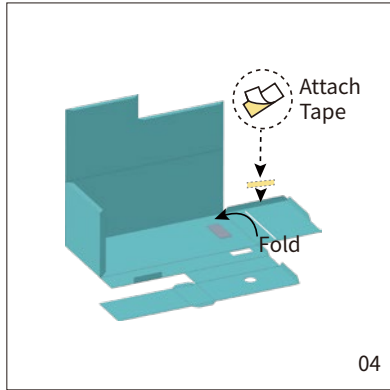

5. Paste it with double-sided tape and fix it

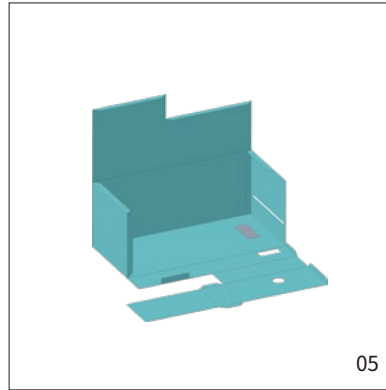

6. Paste the finished motor base as the picture shows then fix it

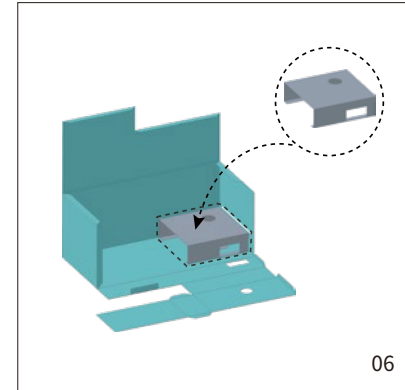

7. Place the electronic modules under the motor base and fix it

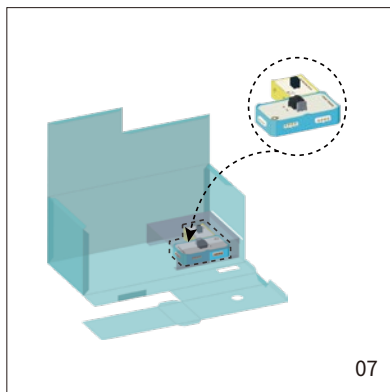

8. Fold it as the picture shows

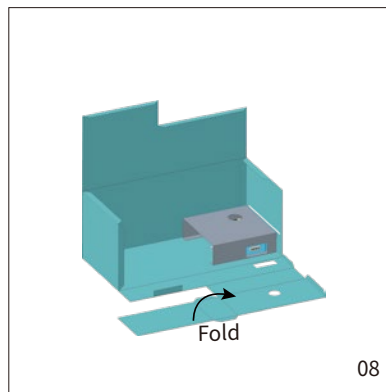

9. Turn 90 degrees and fold it as the picture shows

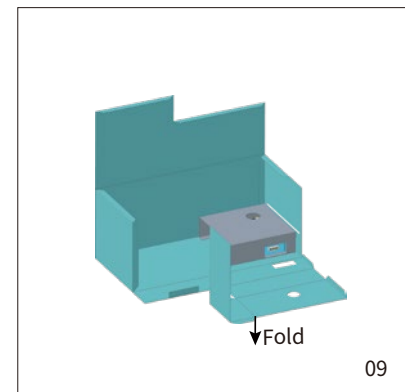

10. Fold it as the picture shows

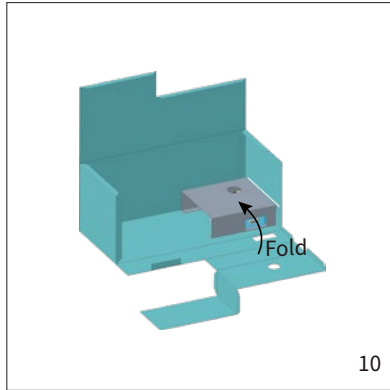

11. Fold it as the picture shows

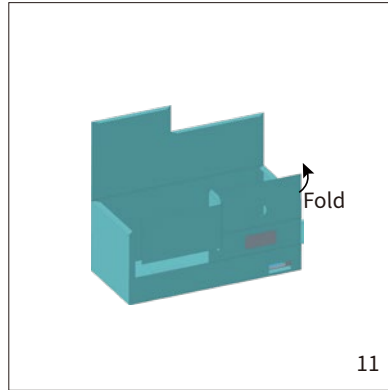

12. Fold it as the picture shows

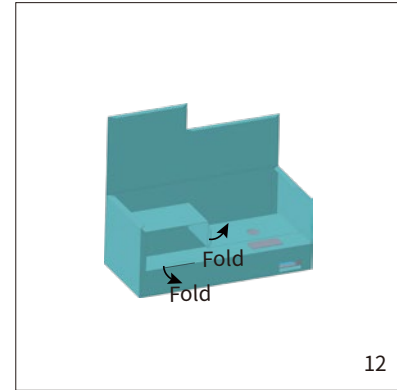

13. Fix the double-sided tape as the picture shows

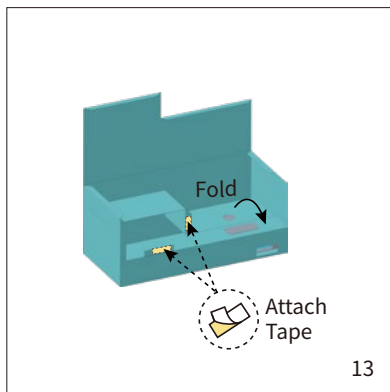

14. Fold it as the picture shows

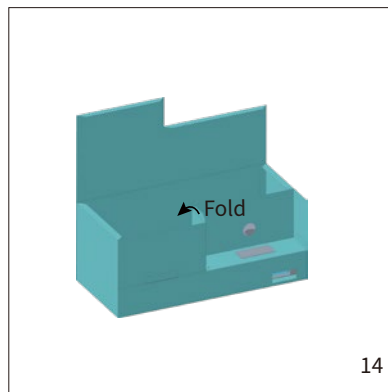

15. Install the DC motor as the picture shows

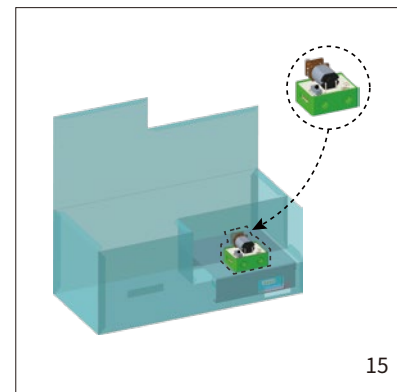

16. Install the wheels on the DC motor

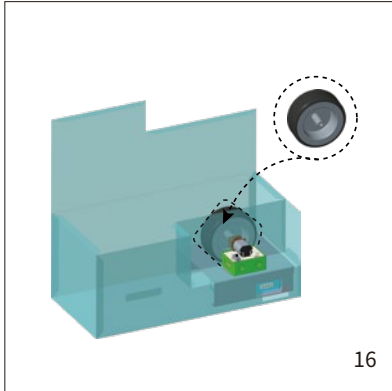

17. Fold it as the picture shows

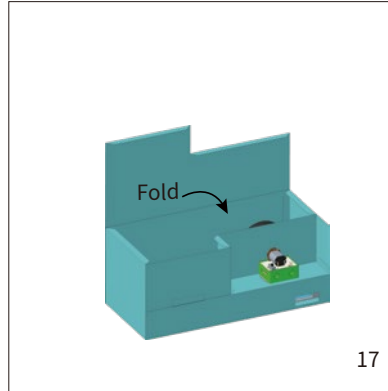

18. Close the lid as the picture shows

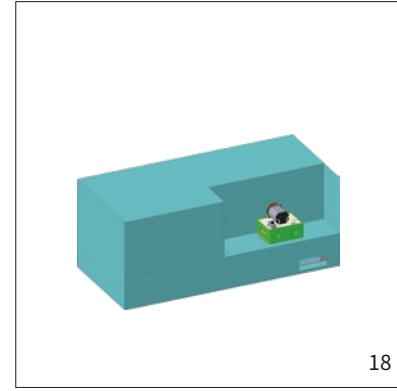

19. Connect the circuit with magnetic cable

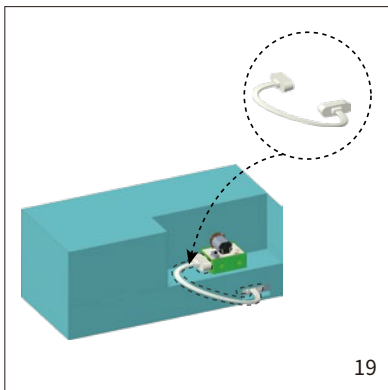

20. Finished

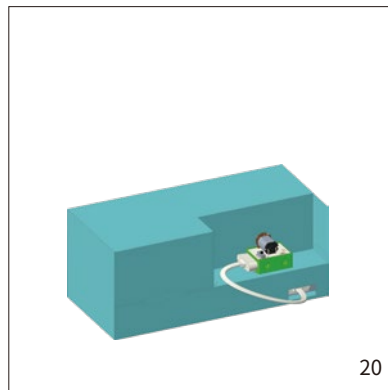

6. Game Interactions

Invite your families or friends to experience your smart money box!
You can earn "pocket money" by helping with housework or other tasks.
Test how much money your smart money box can save!



7. Brainstorming

IR reflective sensor and DC motor are used in this project. The DC motor is widely used in our daily life, such as toy racing cars and electronic fans. IR reflective sensors are normally used in smart detection devices or smart tracking cars. Try designing a smart detection device with IR reflective sensor, to detect whether there is something approaching and make an anti-collision alarm device. Or you can use the DC motor module to make a small car or a miniature electric fan with the fan blades.

Monkey Rock Climbing

1. Learning Goals:

1. Learn how to use the vibration sensor module
2. Know the components of monkey rock climbing
3. Master building a monkey rock climbing

2. Supplies List:

• Electronic supplies:

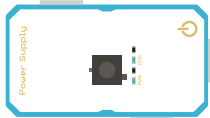

Medium Power Supply



IR Reflective

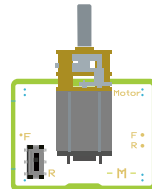

DC Motor

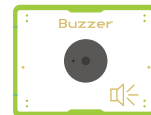

Buzzer

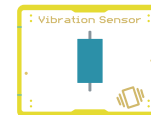

Vibration Sensor



Magnetic Cable

• Structure Supplies:

Paper Model for Monkey Rock Climbing

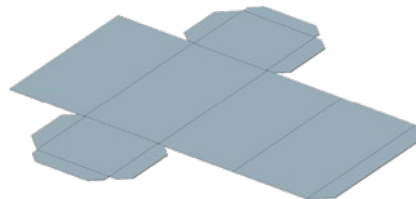
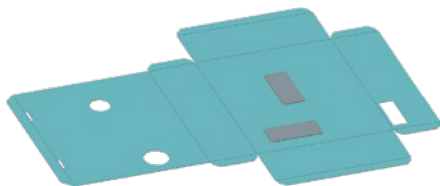

Clip



String



3. Application

Rock climbing is a very popular sport nowadays, which can exercise our physique and enhance our physical fitness, also bring us mental pleasure. In addition to human beings, the monkeys on the rockery in the zoo also like rock climbing very much. They can climb flexibly and swiftly on the steep rock wall. Next, let's make a simulating monkey rock climbing!



4. Knowledge Analysis

1. Modules Introduction :

- **Vibration Sensor:** It can monitor the vibration in the environment, and then transmit the vibration signal to the output module, so the vibration sensor can be used as a vibration switch.

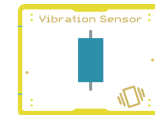

2. Circuit Connection: The whole set of simulating a monkey rock climbing is composed of medium power supply, IR Reflective sensor, vibration sensor and DC motor. Connect them according to following circuit diagram:



3. How Circuit works: The vibration sensor functions as a switch. When vibration is detected, the circuit is turned on, and the motor is controlled to rotate so that the string drives the monkey to climb up. If the monkey climbs to a certain height and is detected by the infrared sensor, the buzzer will emit an alarm sound.

5. Model Building

1. Build rockery supporting base

1. Unfold the paper model and fold it as the picture shows

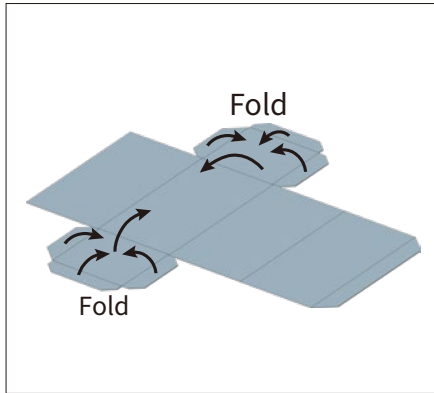

2. Past the double-sided tape at the corresponding position and fold the paper model as the picture shows.

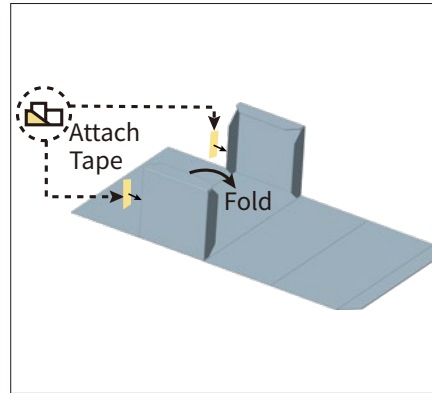

3. Paste it with double-sided tape and fold it as the picture shows

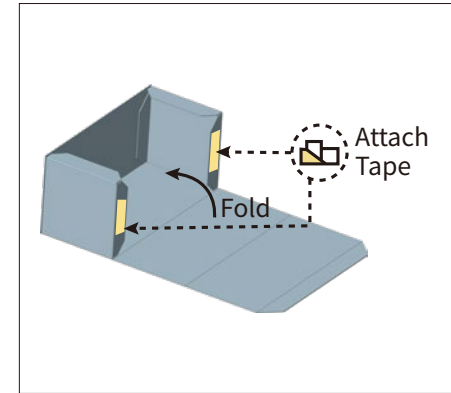

4. Fold it as the picture shows

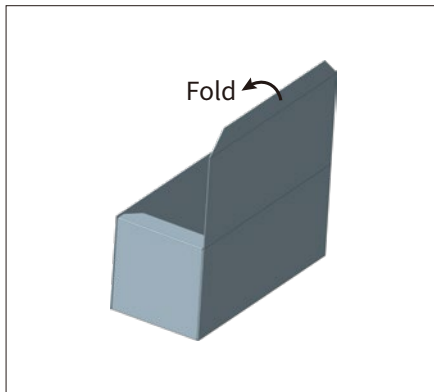

5. Fold it as the picture shows

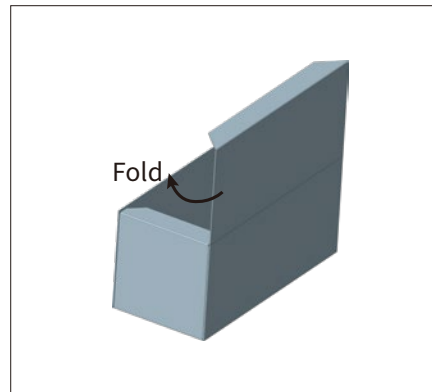

6. The finished rockery supporting base should be like this

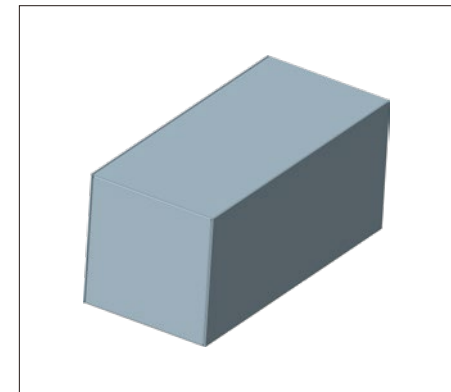

2. Build rockery

1. Unfold the paper model and fold it as the picture shows

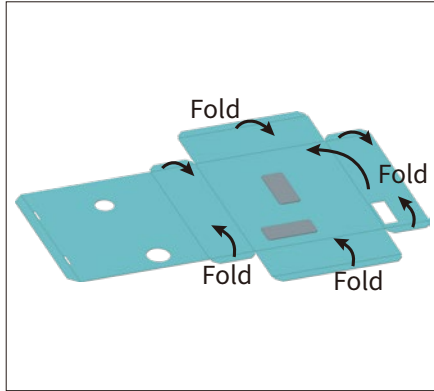

2. Fold it as the picture shows

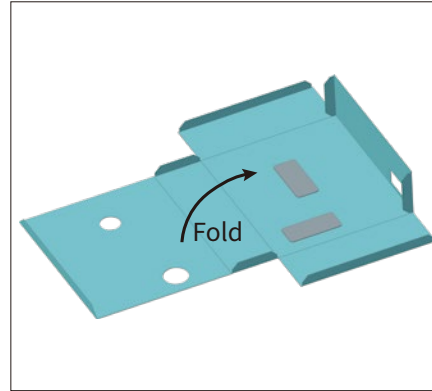

3. Fix it with double-sided tape pasted and fold it as the picture shows

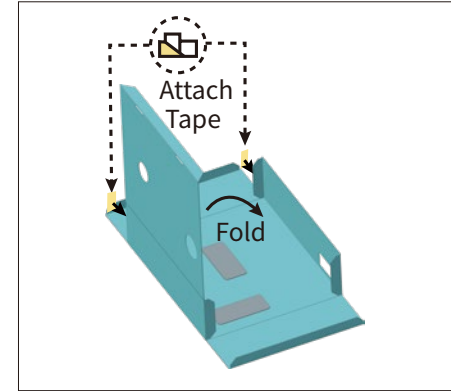

4. Fix it with double-sided tape pasted and fold it as the picture shows

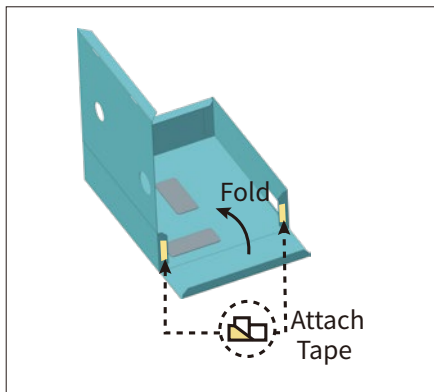

5. Turn the paper model 90 degrees

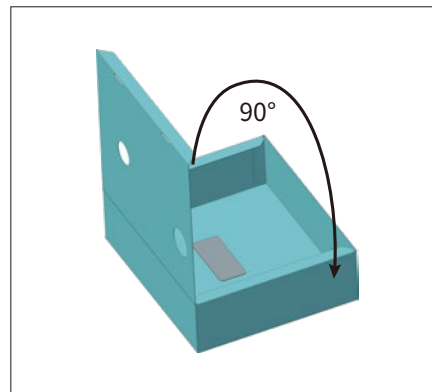

6. Place the paper model as the picture shows

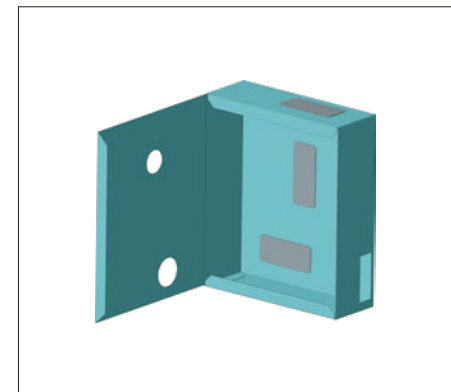

7. Put the connected modules into the paper model

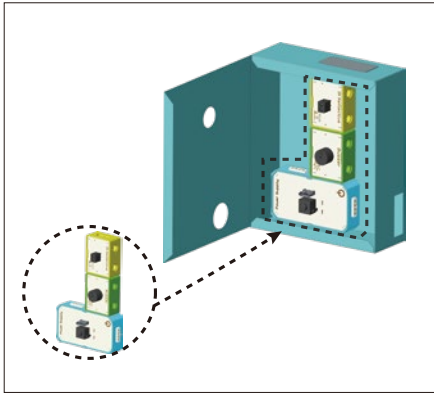

8. Mount the 4 rubber gasket on the motor shaft in turn

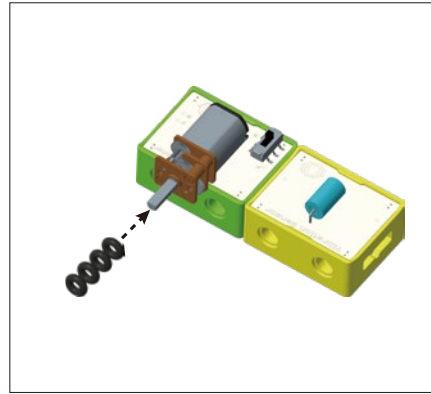

9. Rubber gasket mounted as shown

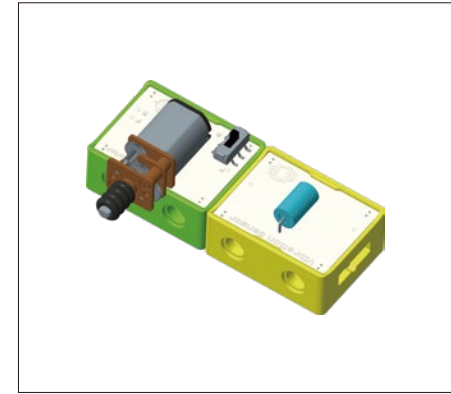

10. Install the module with rubber gasket mounted on the paper model and fix it

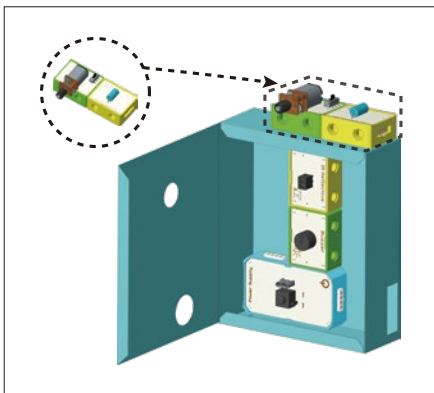

11. Connect the magnetic cable and fold the paper model as the picture shown

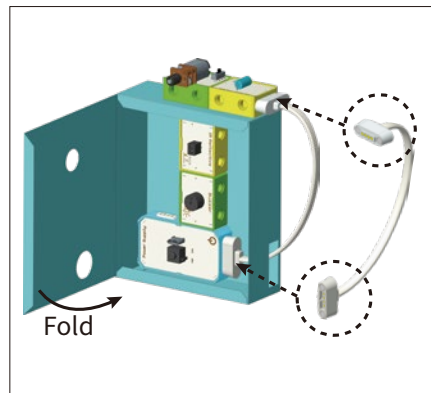

12. Fix the paper model with clip

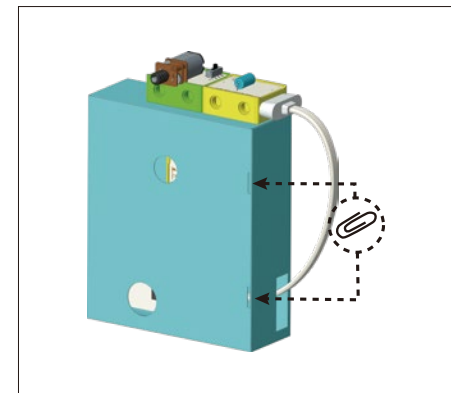

13. Rockery finished

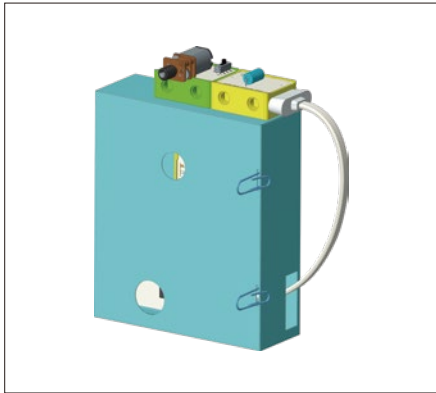

3. Fix monkey and rockery supporting base

1. Thread through the small hole on the head of monkey with string and tie a knot

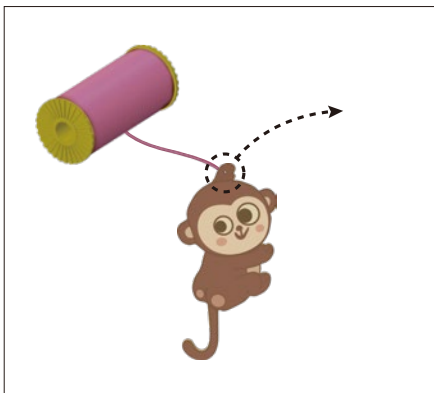

2. Fix the other side of the string on the motor shaft

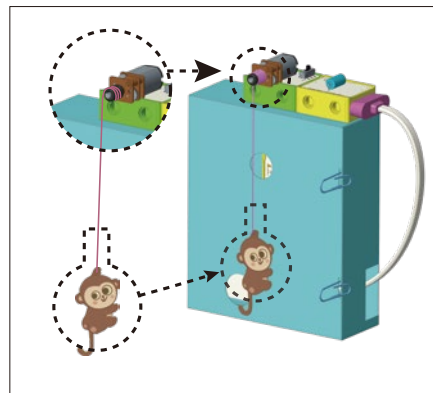

3. Paste the double-sided tape on the supporting base

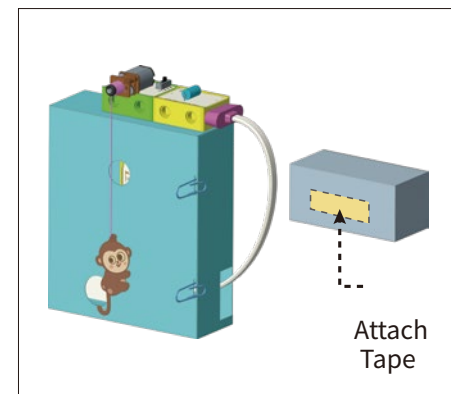

4. Turn the monkey rock climbing 45 degrees and fix the supporting base

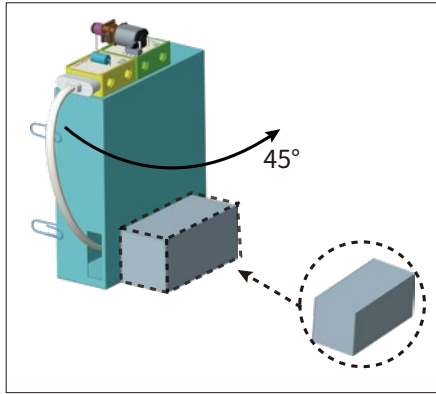

5. Finished



6. Game Interactions

- **How to use:** Control the monkey to climb up the rock by repeatedly tapping the desktop. The vibration caused by tapping the desktop will trigger the vibration sensor.

- **Game rules:**

1. Put the monkey down the mountain before starting the game. Use the buzzer alarm as the signal when the monkey climbed to the top of the mountain;
2. Take turns to race and time, and compare who can make the monkey climb to the top of the mountain in the shortest time!



7. Brainstorming

We can learn the basic knowledge of vibration sensor in this project. Vibration sensor is widely used in daily life. For example, it can be used in gas equipment to detect earthquakes and other disasters. The gas and power will be cut off in time to prevent secondary disasters once the vibration sensor triggered. Try designing a vibration alarm with combining a vibration sensor, an LED, and a buzzer, and then detect whether a running washing machine will trigger an alarm!

Garden Lamp

1. Learning Goals:

1. Learn how the light sensor works
2. Know the circuit of light sensor
3. Master building a garden lamp

2. Supplies List:

• Electronic supplies:

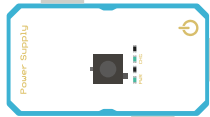

Medium Power Supply

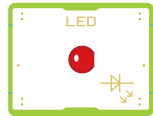

LED

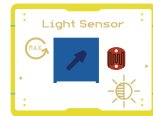

Light Sensor



Magnetic Cable

• Structure Supplies:

Garden Lamp Paper Model

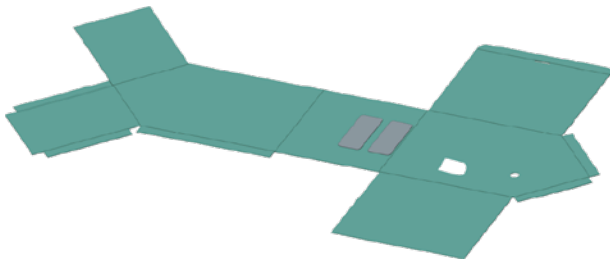

Clip



3. Application

In daily life, you may observe that the street lights will automatically turn on when it's getting dark, and turn off automatically after daybreak. Many houses install the garden lamp in yard or parks for lighting. Do you know who is controlling these lights?

It turns out that the garden lamp uses the light sensor to detect the brightness values of the ambient light to control the ON and OFF of the circuit. When it is dark, the lamp is turned on, and the lamp is turned off at dawn, achieving the function of energy-saving. Next, let's make a work that simulates garden lamps!



4. Knowledge Analysis

1. Modules Introduction :

- **Light Sensor:** It's an analog input module. It's main component is a photoresistor that can change according to different light intensity. Its resistance will decrease as the light intensity increases. You can set its trigger value with the knob. The circuit can be triggered when the ambient light intensity is lower than the trigger value.

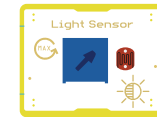

2. Circuit Connection: The simulating garden lamp is composed of medium power supply, light sensor and LED. Connect them according to the following circuit diagram.

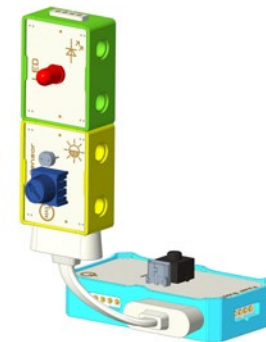

3. How Circuit works: The light sensor functions as a switch. When it detects that it is dark, it turns on the circuit to light up the LED, otherwise it turns off the circuit and the LED goes out.

5. Model Building

• Build a garden lamp

1. Fold it as the picture shows

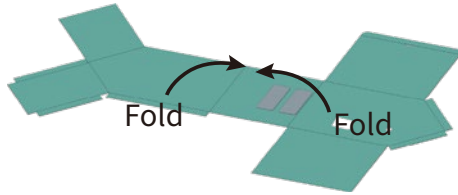

2. Fold it as the picture shows

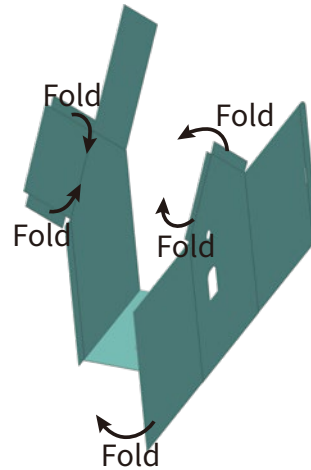

3. Paste it with double-sided tape and fold it as the picture shows

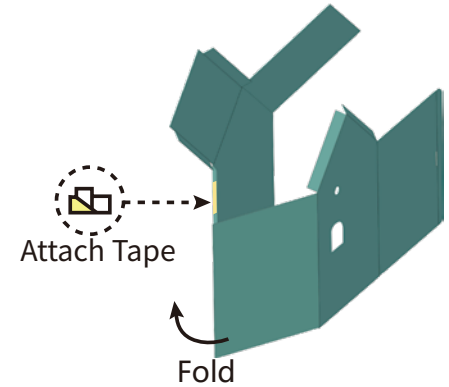

4. Paste it with double-sided tape and fold it as the picture shows

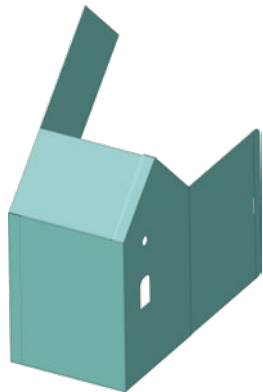

5. The paper model should be like this after step 4

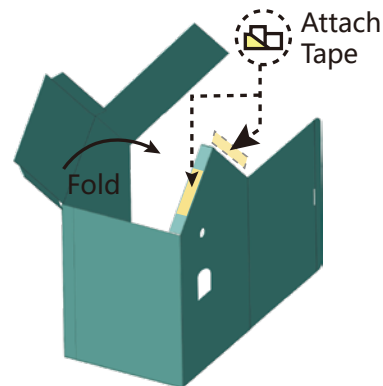

6. Place the connected modules at the corresponding position

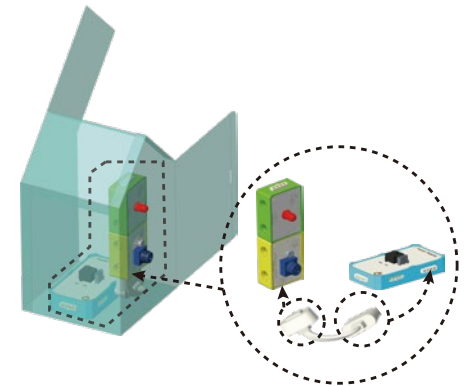

7. Turn it 90 degrees and fold the lid to paste it

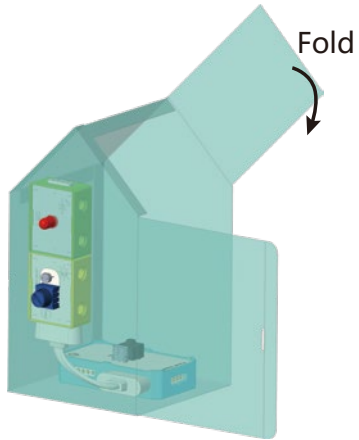

8. Close the paper model

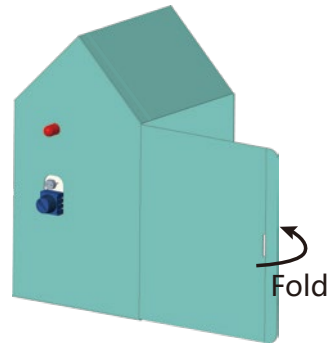

9. Fix it with clip as the picture shows

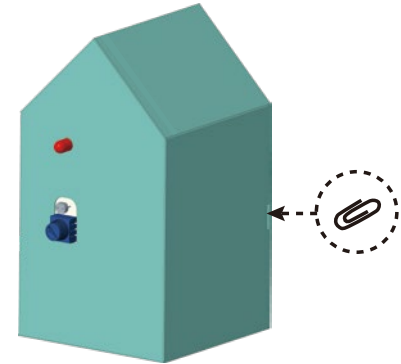

10. Finished

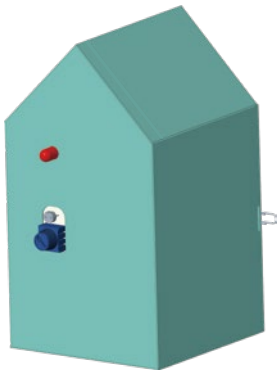

6. Game Interactions

Invite your families or friends to experience your amazing simulating garden lamp together!

- **How to play:**

The host is responsible for adjusting the indoor lighting, and other participants (more than 2 people) are responsible for adjusting the light sensor on the garden lamp device to see whether it can control the lighting of the courtyard lamp according to the changes in the external environment!

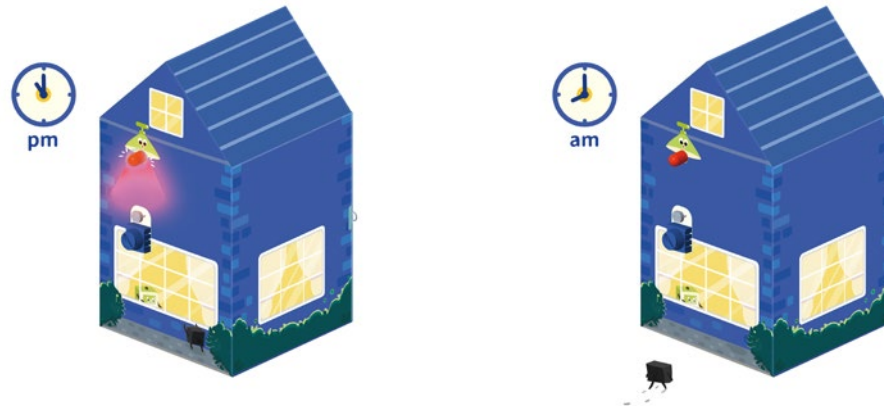

7. Brainstorming

You can learn the knowledge of light sensor in this project. Light sensors are widely applied in daily life. For example, they can be used as a component in mobile phones, tablets, and keyboards. These devices will change the brightness of the screen or lights as the ambient light changes. You can also use the light sensor and LED to make a smart desk lamp, and control its on/off and brightness through the light sensor knob.

Crazy Swing Ride

1. Learning Goals:

1. Learn how the switch works
2. Know the circuit of swing ride
3. Master building the structure of a swing ride

2. Supplies List:

• Electronic supplies:

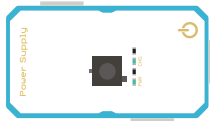

Medium Power Supply

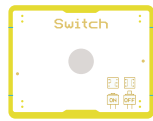

Switch

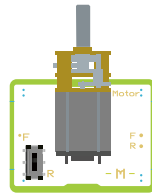

DC Motor



Magnetic Cable

• Structure Supplies:

Lego Structure Part (The complete Lego bar chart is on page 106, 107)

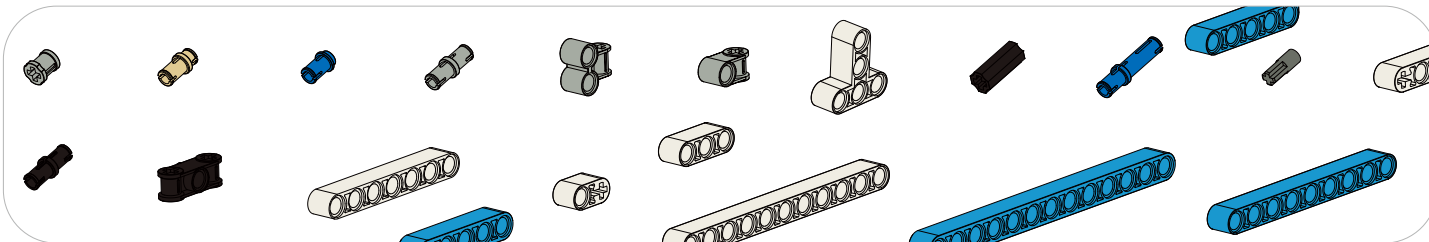

3. Application

Swing ride, also called "Chair-O-Planes", is one of the most popular ride in amusement parks. The ride rotates or moves up and down around a fixed central column. Do you know how the swing ride works? The swing ride rotates since the motor movement will drive the the turntable on the rotating flying chair to rotate. Next, let's make a simulating swing ride!

4. Knowledge Analysis

1. Modules Introduction :

- **Switch:** It's a digital input module, similar to the switch of light in home. When it is pressed, the switch is self-locking and the circuit is turned on. When pressed again, it bounces and the circuit is disconnected.

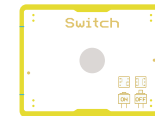

- #### 2. Circuit Connection:
- The swing ride is composed of a medium power supply, a switch and a DC motor. Connect them according to the following circuit diagram.

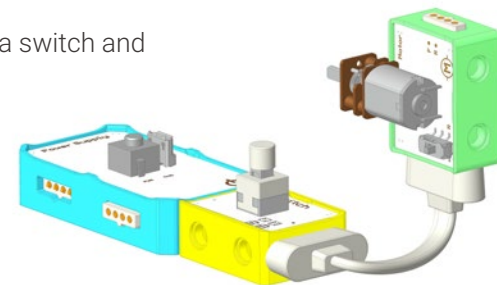

- #### 3. How Circuit works:
- When the power is turned on and the switch is pressed, the DC motor starts to rotate and control the turntable of the swing ride to rotate by the gear acceleration transmission.

5. Model Building

• Build a swing ride

01

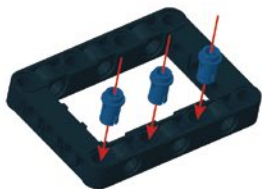

02

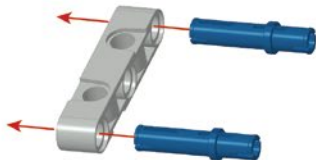
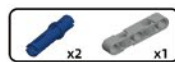

03

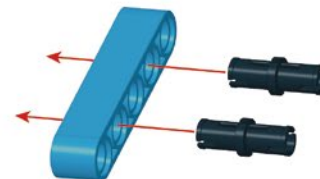

04

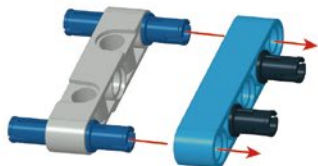

05

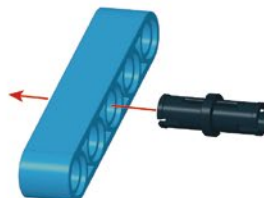

06

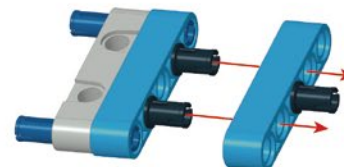

07

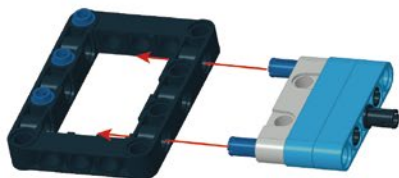

08

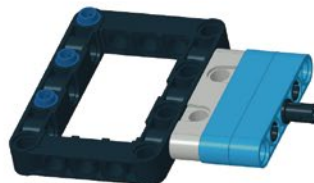

09



10



11



12

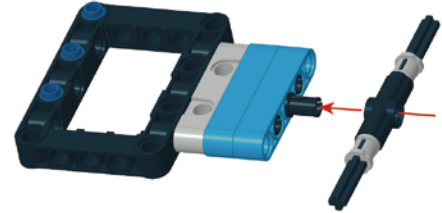

13

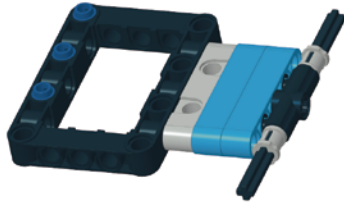

14

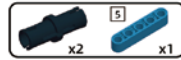
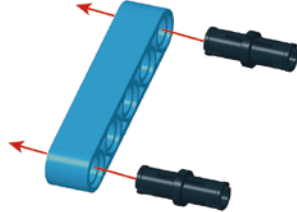

15

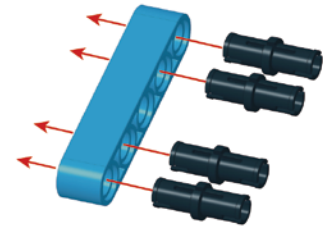

16

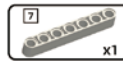
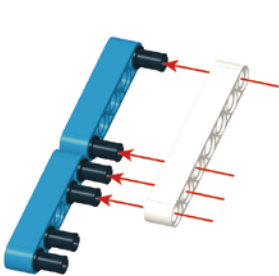

17



x2

18

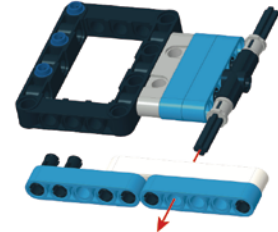

19

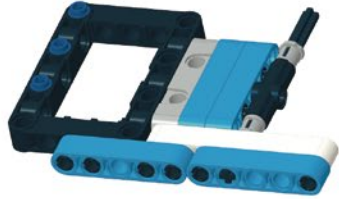

20

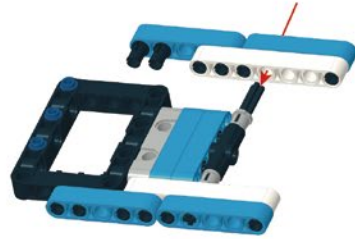

21



22



23

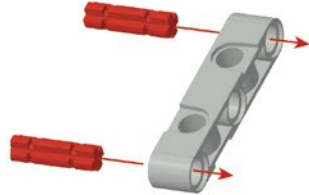

24

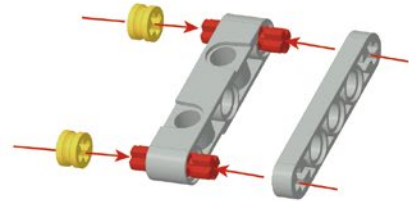

25



26

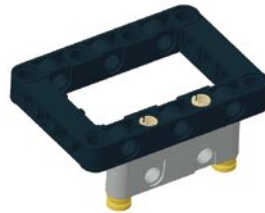

27

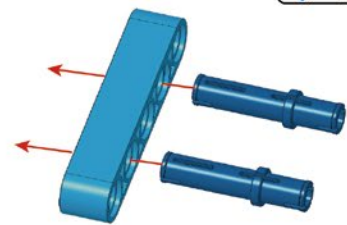
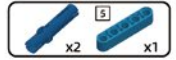

28

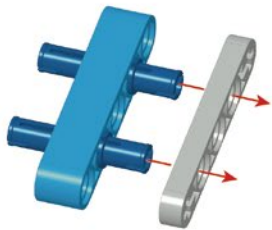

29

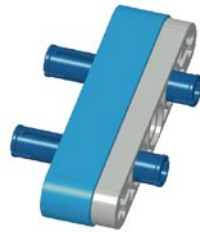

30

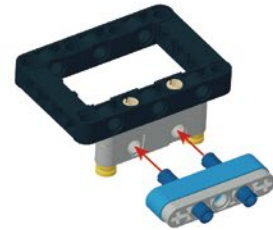

31



32

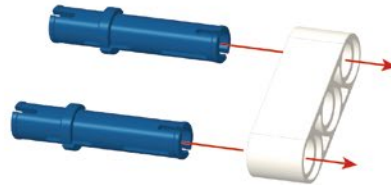

33

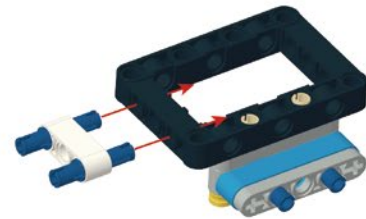

34



35

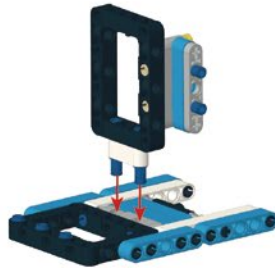

36



37



38



39

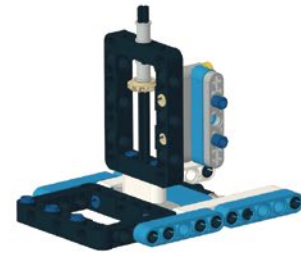

40



41

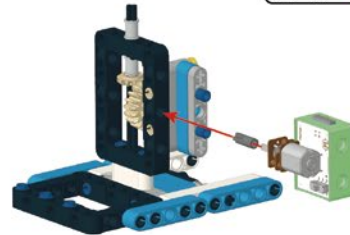

42

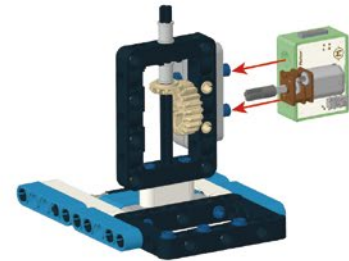

43

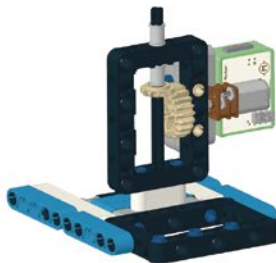

44

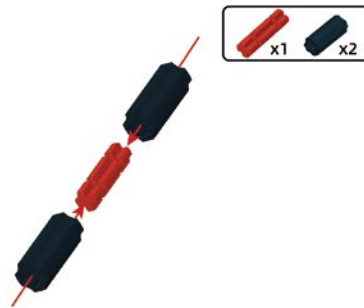

45



46



47



48



49



50



51

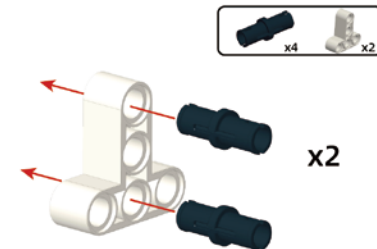

52

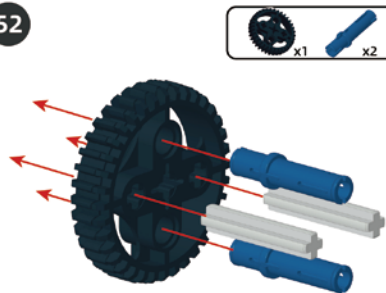

53

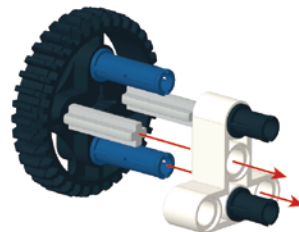

54

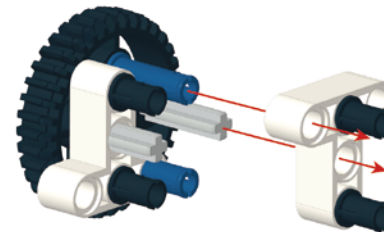

55



56



57



58

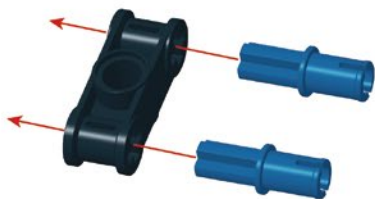

59

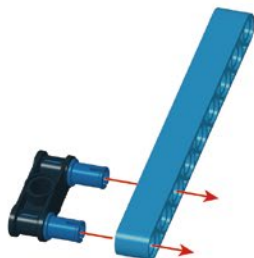
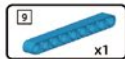

60



x4

61



62



63



64

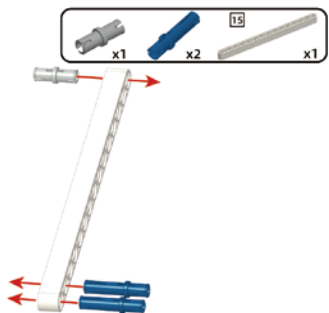

65

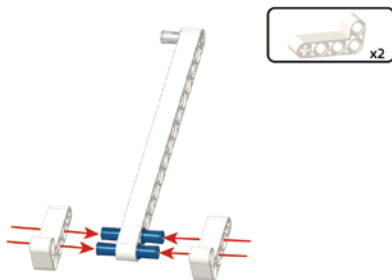

66



67



68



69

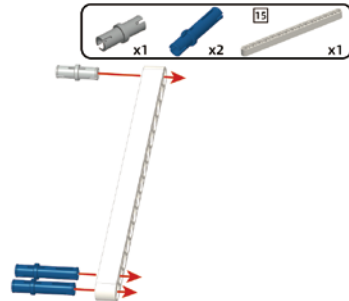

70

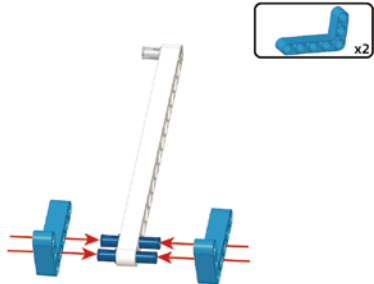

71

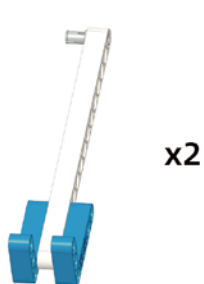

72



73



74



75



76



6. Game Interactions

Invite your families and friends to experience your swing ride!

- **Game Rules:**

1. This game needs 2-4 people to join in. You can design a "little man" model with paper-cutting, then paste it with double-sided tape on the swing ride;
2. Press the power button and turn the switch on. Compete who can stay on the swing ride for the longest time!



7. Brainstorming

In this project, we mainly used switch, DC motor and Lego structural parts to build a swing ride. Switches are widely used in life, such as home light switches, machine start buttons, etc. Can you build other different projects with switch, DC motor and Lego structural parts? For example, a simulating electric gate. Or you can try replacing the switch with IR sensor or vibration sensor to see what unexpected effects will have.

Flexible Clamp

1. Learning Goals:

1. Learn how the circuit of flexible clamp works
2. Know the structure of a flexible clamp
3. Master how to build a flexible clamp

2. Supplies List:

• Electronic supplies:

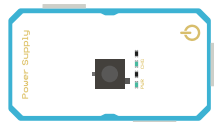

Medium Power Supply

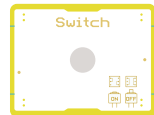

Switch

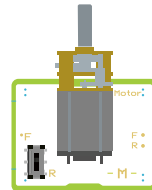

DC Motor



Magnetic Cable

• Structure Supplies:

Lego Structure Part (The complete Lego bar chart is on page 106, 107)

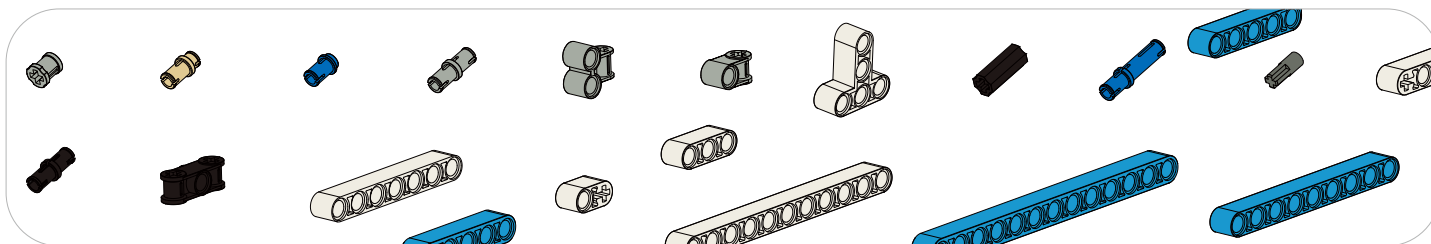

3. Application

You may find the flexible structures are widely used in our daily life, such as selfie sticks, climbing canes, fruit pickers, retractable gate etc. All of them adapt the flexible structures skillfully. Do you know the advantages of flexible structures? It turns out that it can effectively save space when it is contracted, which is convenient for storage. It can extend the space when it is used, which is convenient and labor-saving. Next, let's make a flexible clamp together!

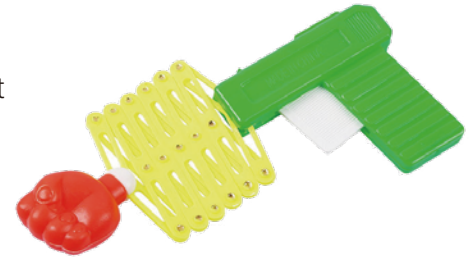

4. Knowledge Analysis

1. Circuit Connection: The flexible structure is composed of medium power supply, switch and DC motor. Connect them according to the following circuit diagram:



2. How Circuit works: Turn on the power supply and the switch. The DC motor will rotate to allow the flexible clamp to flex and pinch.

5. Model Building

- Build the flexible clamp

01

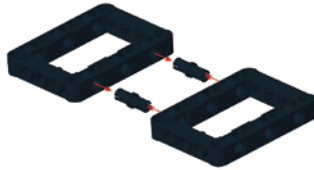

02

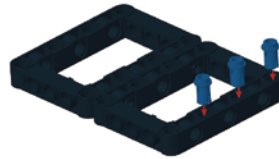

03

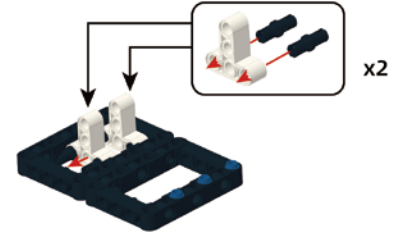

04

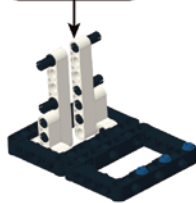
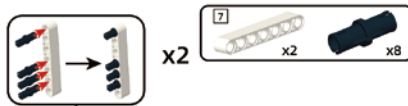

05

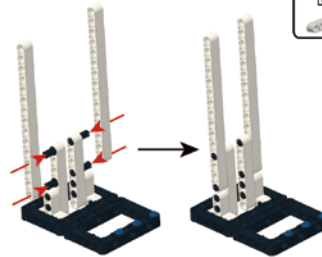

06

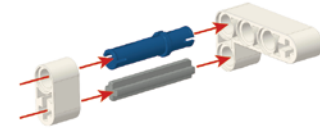

07

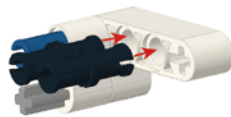

08

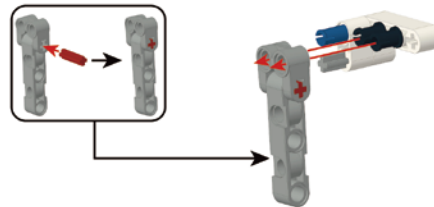

09

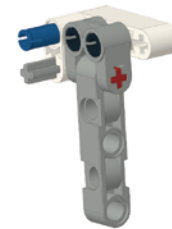

10

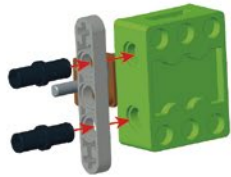

11

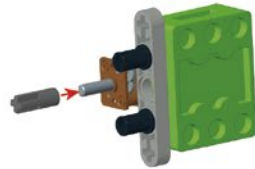

12

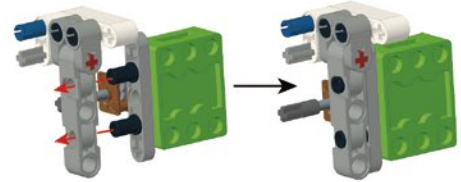

13

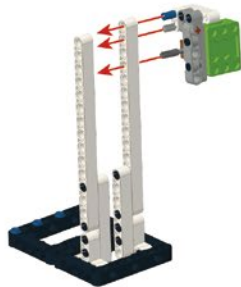

14



15



16

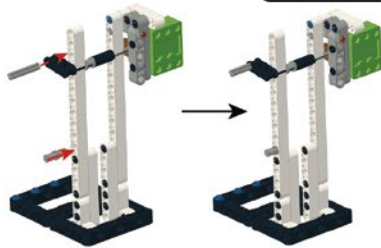

17

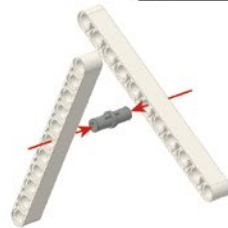
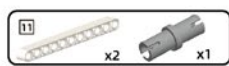

18

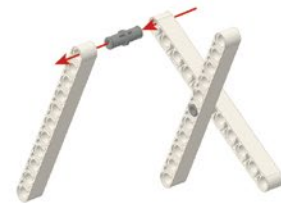

19

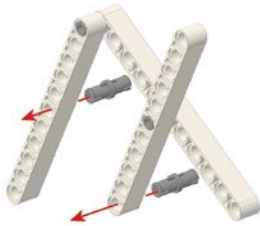

20

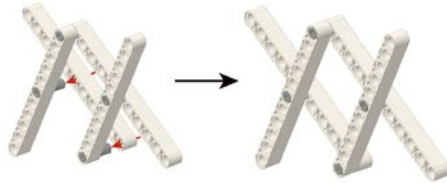

21

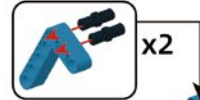

x2



22



23



24



25



26

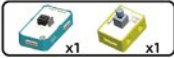

27



6. Game Interactions

Invite your families or friends to play the flexible clamp decoration games together!

- **Game Rules:**

1. Everyone designs a sticker according to the features of the flexible clamp;
2. Paste the sticker on the clip, start the flexible clamp, and compete whose sticker is the best matched with its flexible clamp.

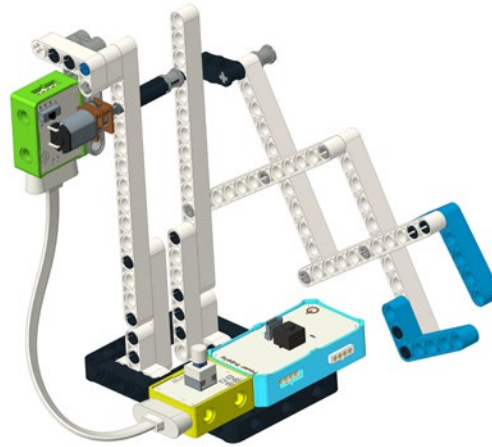

7. Brainstorming

We used switch, DC motor and Lego structure parts to build a flexible clamp in this project. There are many other applications of flexible structures in life, such as lift platforms, flexible gates, etc. You can use the existing supplies to create a project independently. Try whether you can design other works like boxing arm, flexible gate or automatic seesaw.

Non-contact Control Car

1. Learning Goals:

1. Learn how the non-contact control car works
2. Know the circuit connection of the non-contact control car
3. Master how to build a non-contact control car

2. Supplies List:

• Electronic supplies:

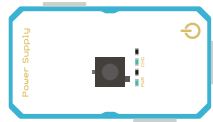

Medium Power Supply



IR Reflective Sensor

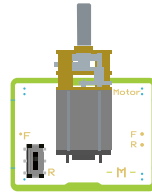

DC Motor



Magnetic Cable

• Structure Supplies:

Lego Structure Part (The complete Lego bar chart is on page 106, 107)

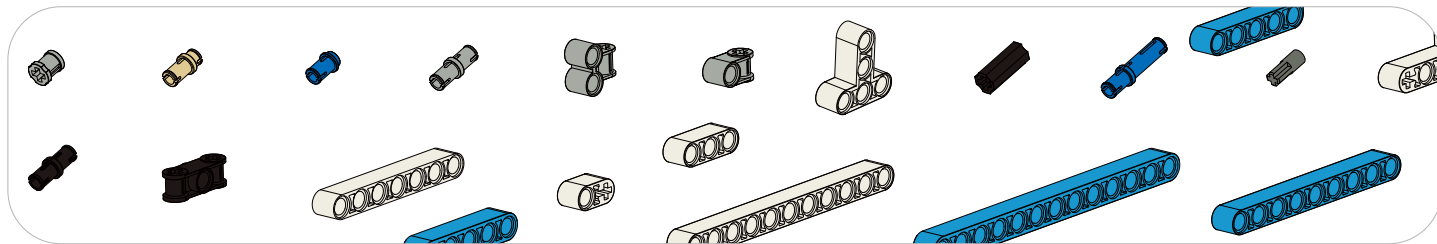

3. Application

In 1885, German engineer Karl Benz created the world's first gasoline-powered three-wheeled car, which expanded human's living space and improved people's quality of life. With the development of technology, various car will be invented. So, do you know what the development trend of the future car will be like? Obviously, driverless technology under the trend of artificial intelligence and Internet of Everything will bring a new revolution to the automotive industry! Next, let's make a smart car that can be controlled from non-contact!



4. Knowledge Analysis

1. Circuit Connection: The non-contact car is composed of a medium power supply, an IR reflective sensor and a DC motor. Connect them according to the following circuit diagram:

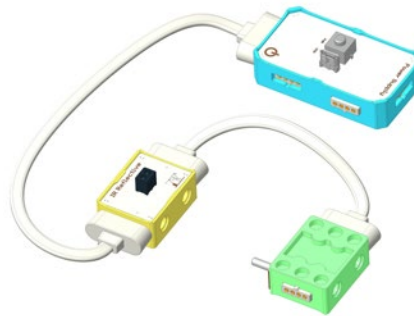

2. How Circuit works: When a non-black object is placed on top of the IR reflective sensor, the IR reflective sensor detects it and triggers the motor to move, thereby controlling the car to move forward, otherwise the car will stand still.

5. Model Building

- Build a remote control car project

01

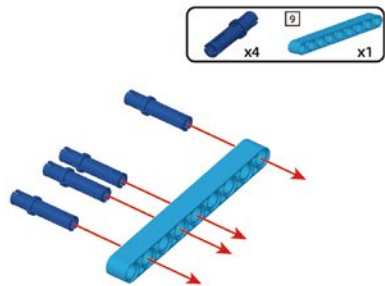

02

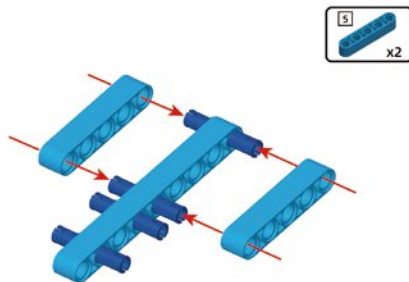

03

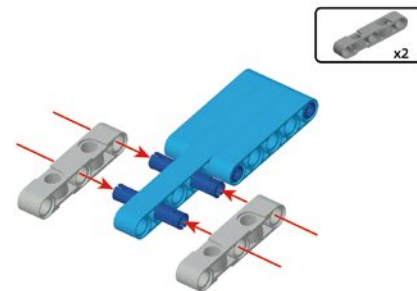

04

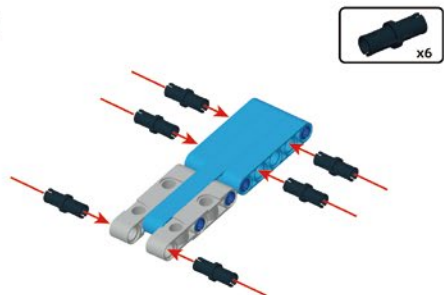

05



06

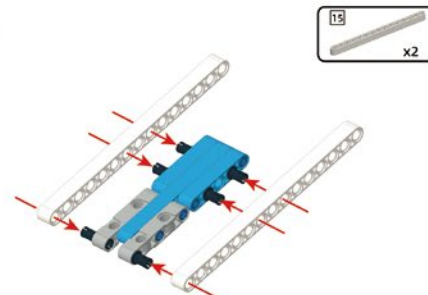

07

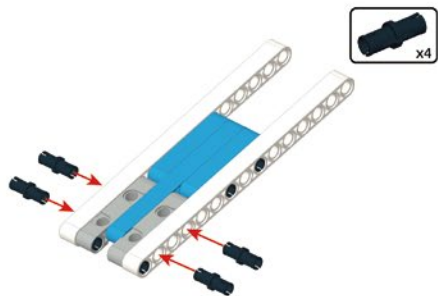

08

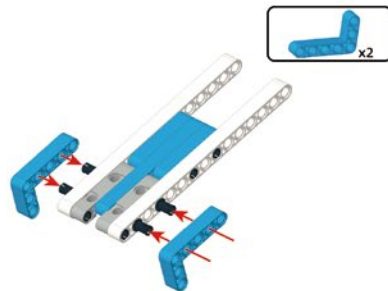

09



10

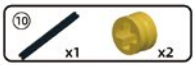

11



12

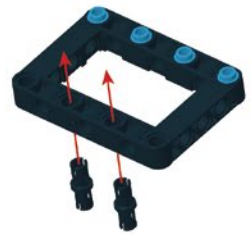

13

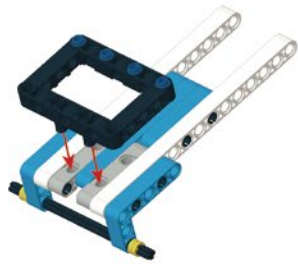

14

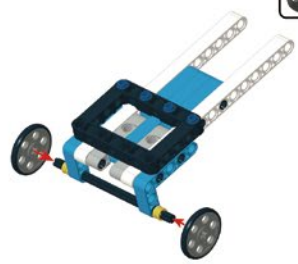

15



16

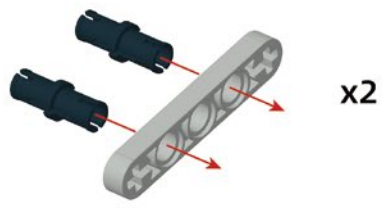

17

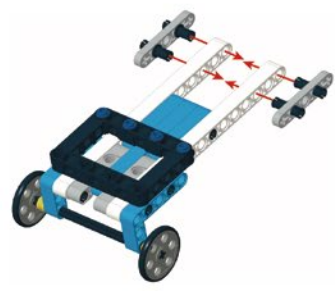

18



19



20

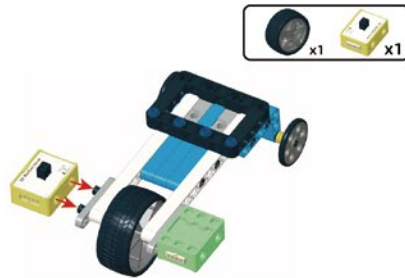

21



22



23



24

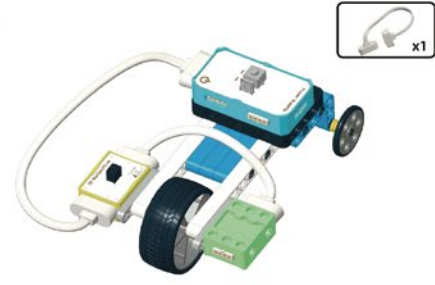

6. Game Interactions

Invite your families or friends to play the non-contact control car race!

- **Game Rules:**

1. 2 or more players take turns to compete;
2. Set the start and end points of the racing track;
3. Start the race and time it. Let's compete who controls the car to reach the destination in the shortest time!



7. Brainstorming

We used the IR reflective sensor and motor in the project. Infrared technology is widely used in life. For example, the remote controls for air conditioners and TV adapt the infrared remote control technology. we can also use the existing materials to design other creative robots, such as smart devices that can detect the drop of a water cup and use a fan to cool down.

Smart Fan

1. Learning Goals:

1. Learn how to use the relay module
2. Know how the circuit of smart fan works
3. Master building a smart fan

2. Supplies List:

• Electronic supplies:

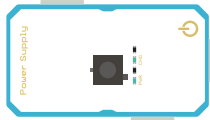

Medium Power Supply



IR Reflective Sensor

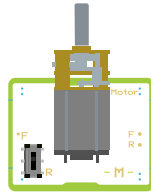

DC Motor

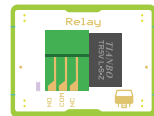

Relay

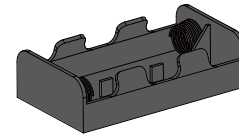

Battery Case



Magnetic Cable

• Structure Supplies:

Lego Structure Part (The complete Lego bar chart is on page 106, 107)

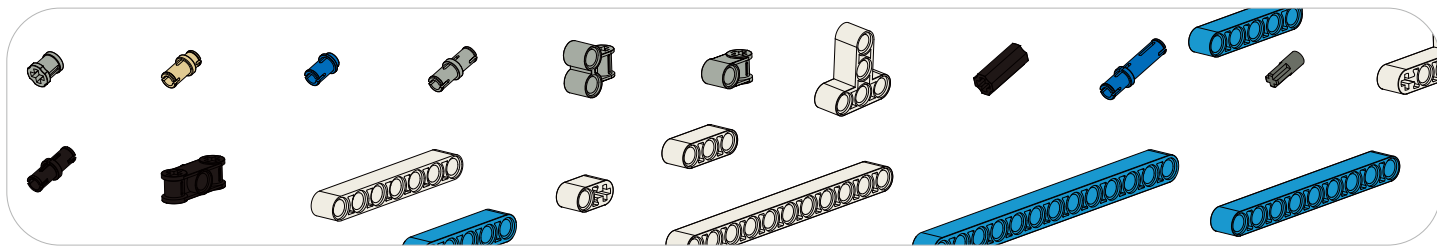

3. Application

The fan is one of the most common heat dissipation tools. We need it to keep cool in the hot summer days. Most of the fans are controlled by button switch. The disadvantage is that if we forget to turn off the fan, it will waste electricity. Next, let's make an energy-saving smart fan together!

4. Knowledge Analysis

1. Modules Introduction :

- **Relay:** It is an electronic control module, which is a kind of "automatic switch" controlled by a small current. It is very safe and convenient to use. Why can a relay be used as a switch? In fact, the principle of the relay is to control the presence or absence of the magnetic field of the internal coil through a small current, thereby controlling the attraction and disconnection of the magnetic switch, and achieve the effect of indirectly controlling the conduction of the large current line. The relay has three interfaces: normal close(NC), normal open(NO) and common(COM). Select the connection according to the actual situation.

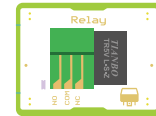

- **DC motor:** It's an output module, which will rotate quick after power on. You can use it to make a mini fan.

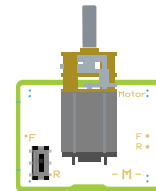

- **Battery Case:** Install two batteries in battery case to power the fan. (**Note:** The kit excludes AA battery, please prepare by yourself.)



2. Circuit Connection: The smart fan is formed by connecting a medium power supply, an IR reflective sensor, a relay, a battery case, and a DC motor. The negative pole of the motor (black wire) and the negative pole of the battery case (black wire) are respectively connected to the normal open (NO) and common(COM) of the relay, and their positive poles are connected. Connect them according to the the following circuit diagram:

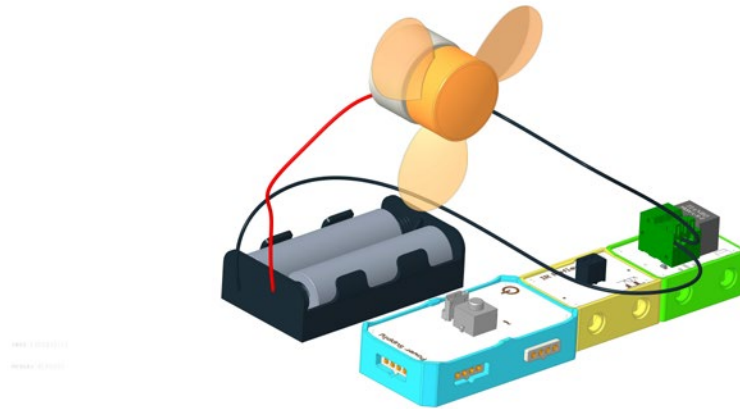

3. How Circuit works: When an object is detected above the IR reflective sensor, the circuit is turned on, and then the relay is turned on, so the large current of the battery case can drive the small fan to rotate, otherwise it turns off and the fan stops.

5. Model Building

• Build a remote control car project

01

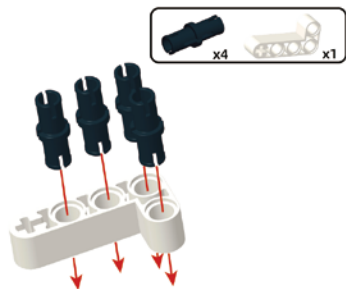

02

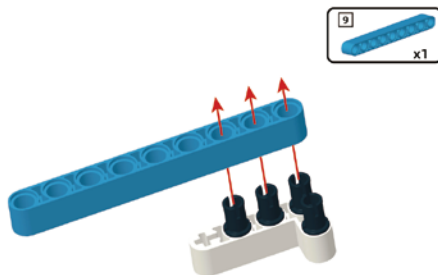

03

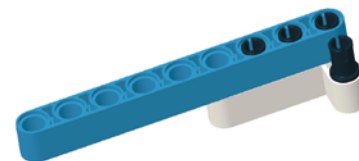

04

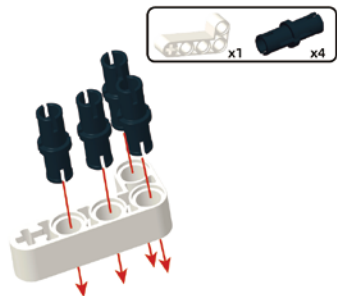

05

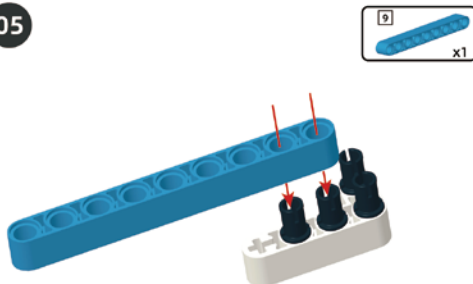

06

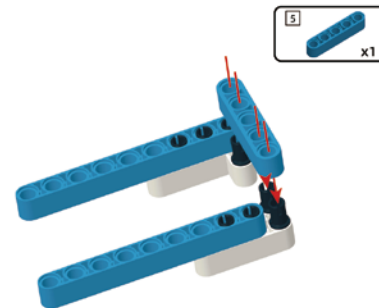

07

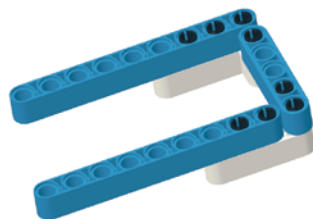

08

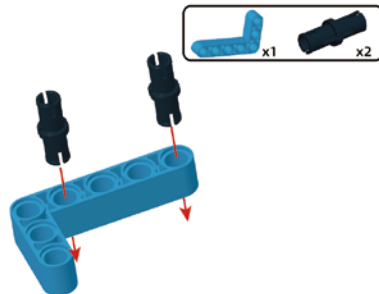

09

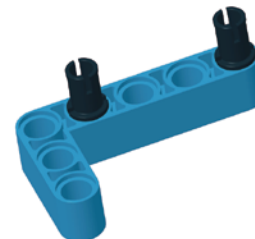

10

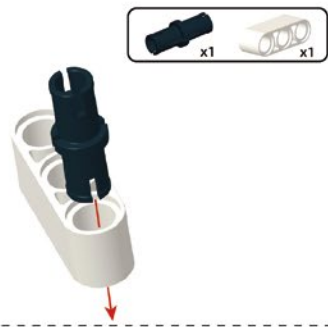

11

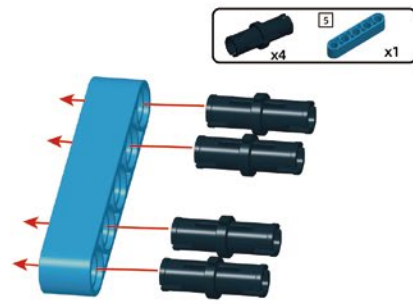

12



13



14



15



16

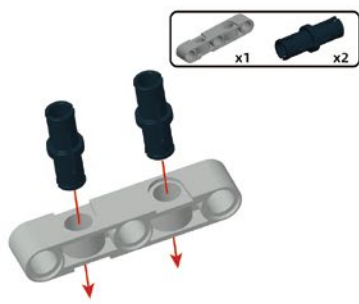

17

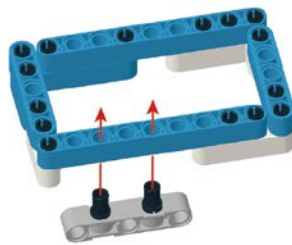

18

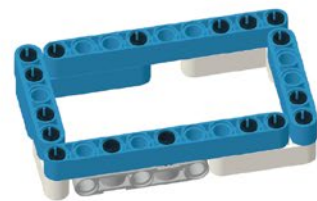

19

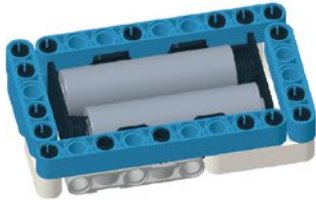

20

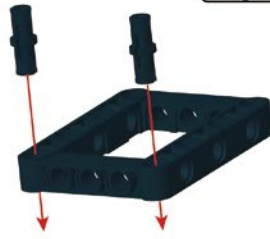

21



22

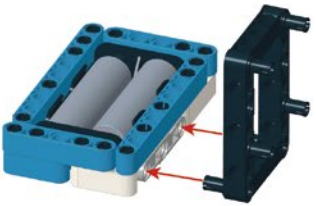

23

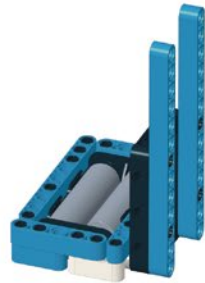

24

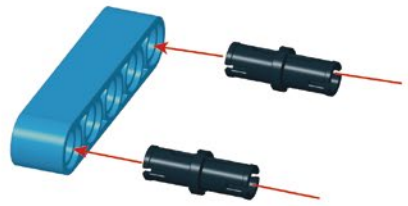

25

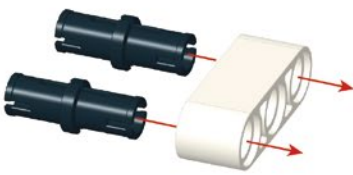

26

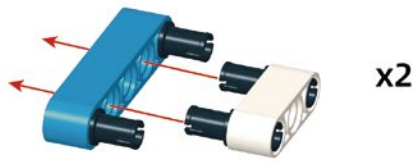

x2

27

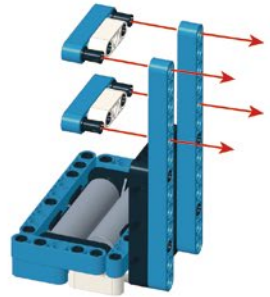

28

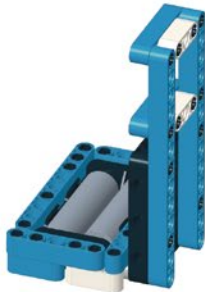

29

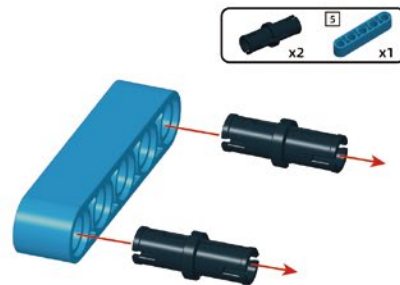

30

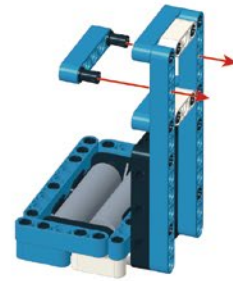

31

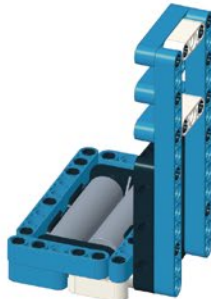

32

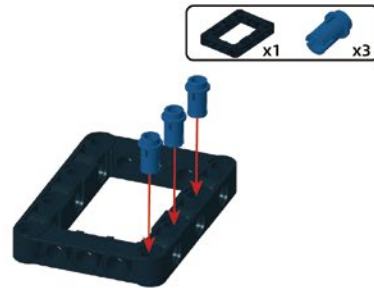

33

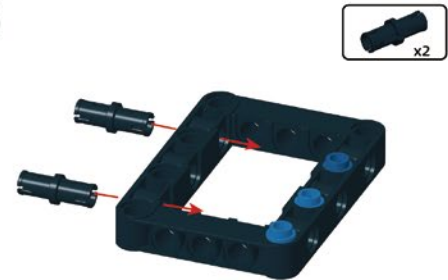

34



35

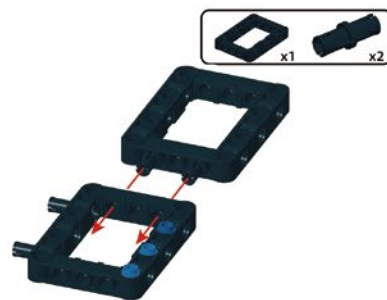

36

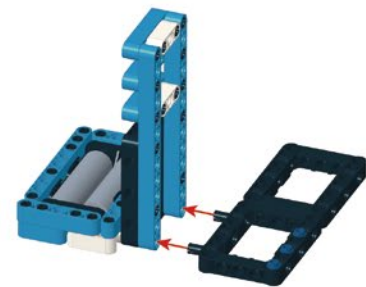

37



38



39



40

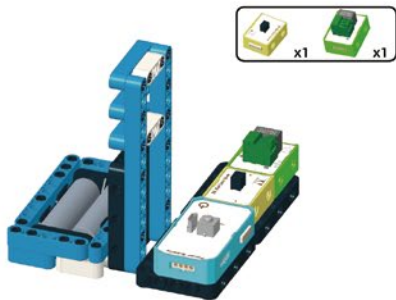

41

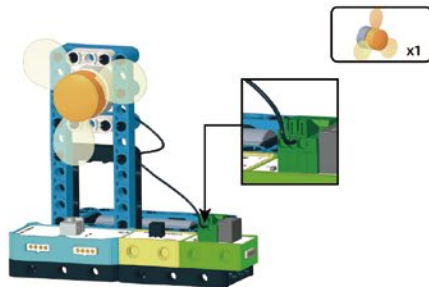

42

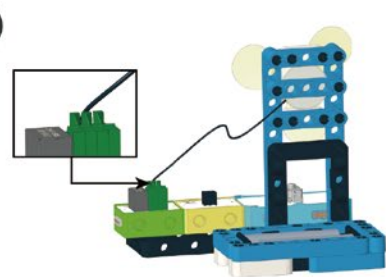

43

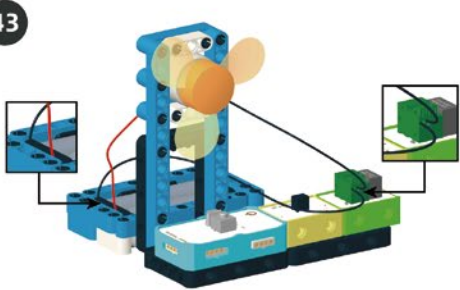

44

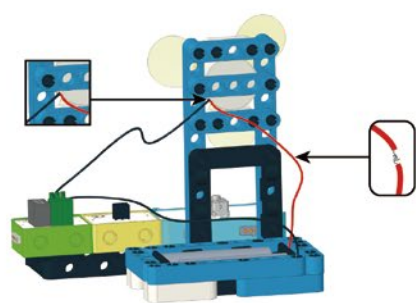

45



6. Game Interactions

Invite your families or friends to experience the smart fan together!

- **Game 1: Paper Remote Control**

2 or more people needed. Each player will design a thin black and white strip of paper, and place it 1cm above the IR reflective and drag it slowly;

Check the status of the fan when the IR reflective detects the black & white striped paper? What is its principle?

- **Game 2: Lucky Turntable**

We provide different turntable stickers. Firstly, remove the fan blades and paste it with the stickers. Then install the pointer, and the smart fan changes to a lucky turntable; let's play the game of lucky turntable together and see who is the luckiest player?

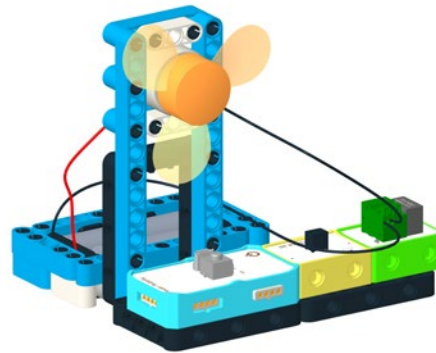

7. Brainstorming

We can learn how the relay works in this project. It can control large current through small current. It's sure that there are many other application cases of small current controlling large current, such as: relay for starting the compressor on air conditioning, for starting the draught fan, for controlling the positive and negative rotation in washing machine, protective relay for controlling the the output of television.

You can also make other creative designs with the existing supplies, such as making different patterns on the fan blades to see the effect of turning. What other creative ideas do you have?

Fitness Expert

1. Learning Goals:

1. Learn how the fitness expert works
2. Master building a fitness expert

2. Supplies List:

• Electronic supplies:

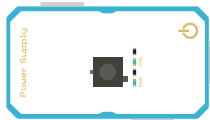

Medium Power Supply

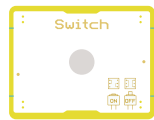

Switch

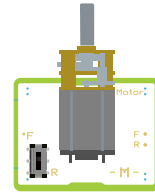

DC Motor



Magnetic Cable

• Structure Supplies:

Lego Structure Part (The complete Lego bar chart is on page 106, 107)

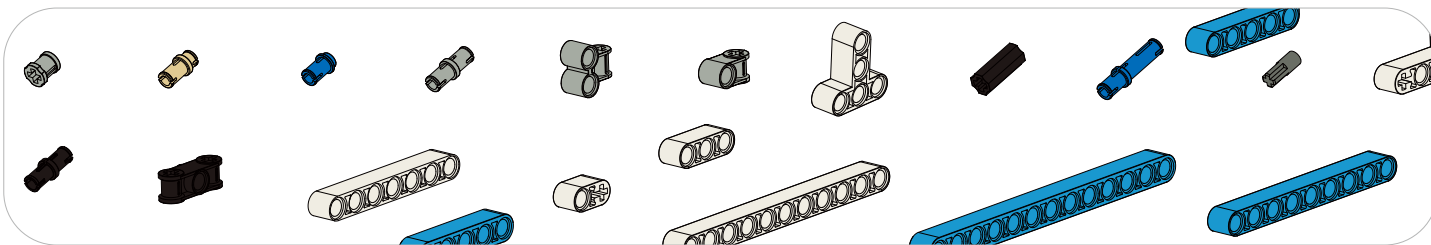

3. Application

With the improvement of living standards, more and more people realize the importance of fitness. Fitness can not only strengthen the body, boost immune system, but also lose weight and get fit, making people feel full of vitality; then, do you know what fitness equipment is available ?



4. Knowledge Analysis

1. Circuit Connection: The fitness expert project is composed of medium power supply, switch and DC motor. Connect them according to the following circuit diagram:



2. How the Circuit Works: Turn on the power supply and the switch, then the DC motor will start rotating to drive the gear on the motor shaft, thus the fitness expert moves its arms.

5. Model Building

• Build a fitness expert project

01

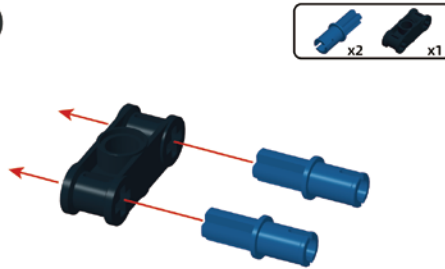

02

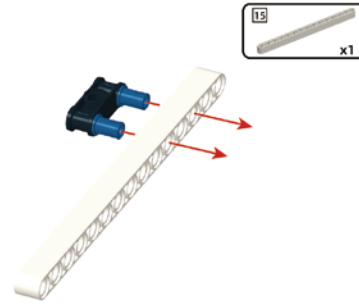

03

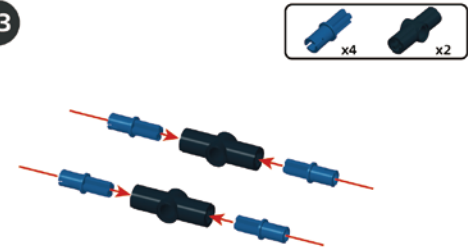

04

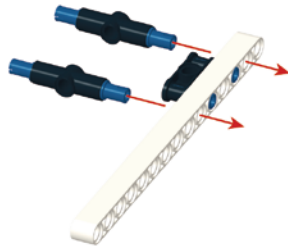

05

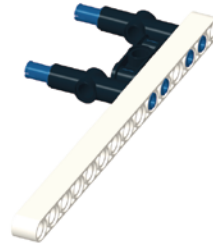

06

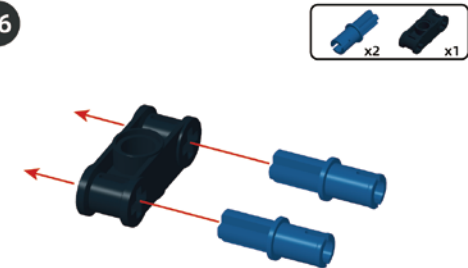

07

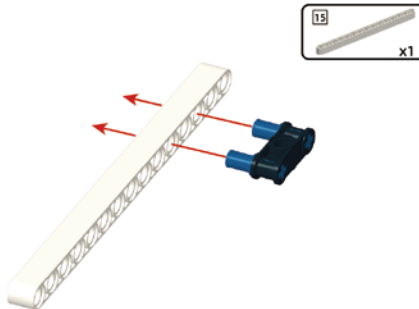

08



09



10



11

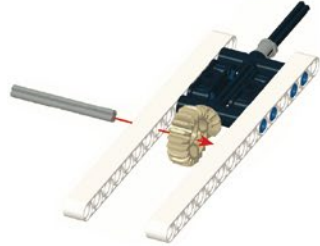
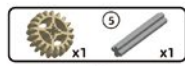

12



13

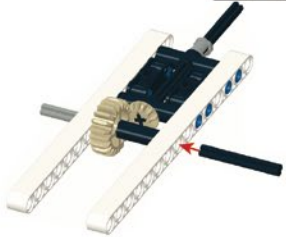
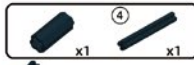

14



15

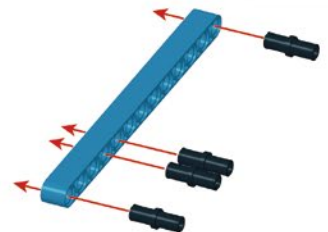
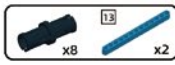

x2

16

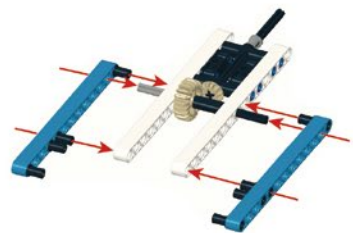

17



18



x2

19



20



21



22

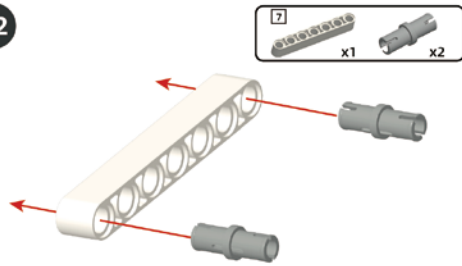

23

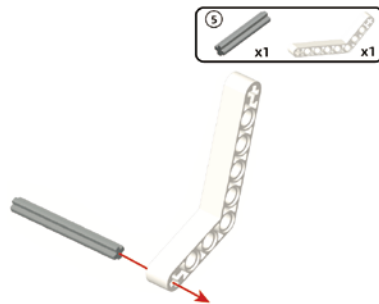

24

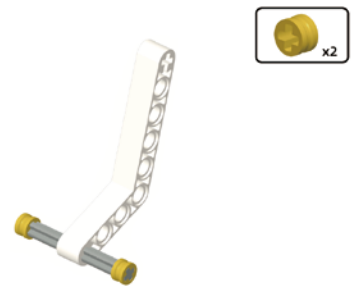

25

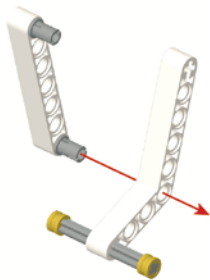

26

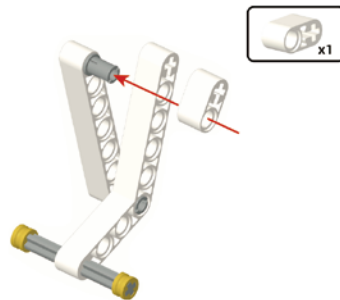

27

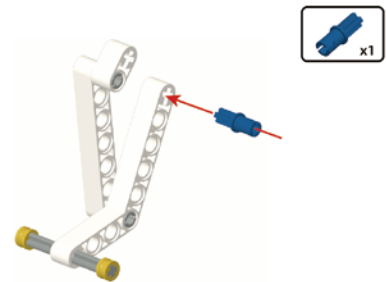

28



29



30



31

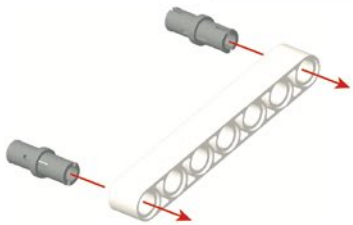
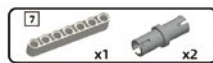

32

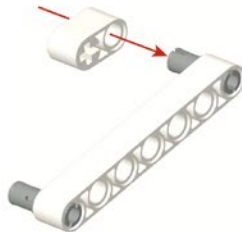

33



34

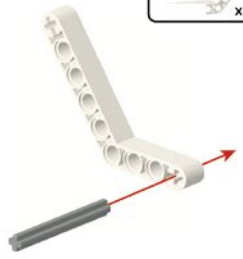
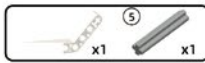

35

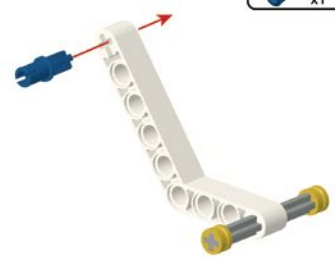

36

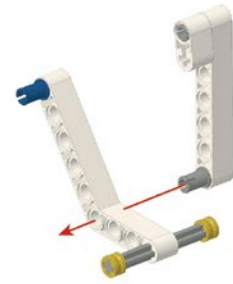

37



38



39

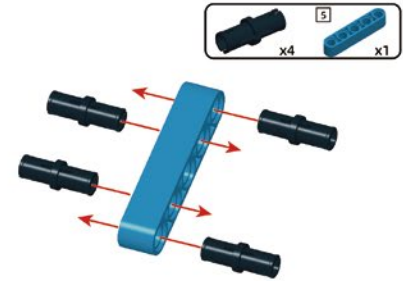

40



41

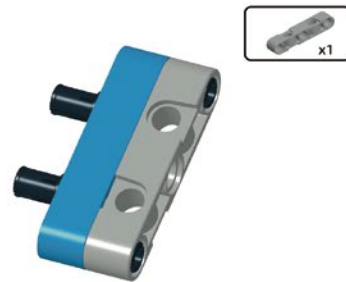

42



43



44

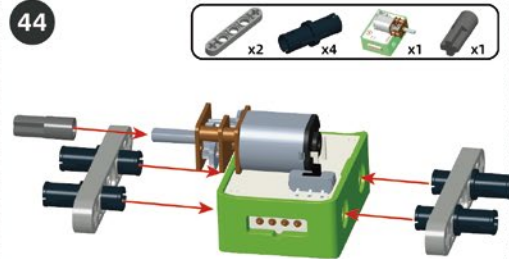

45

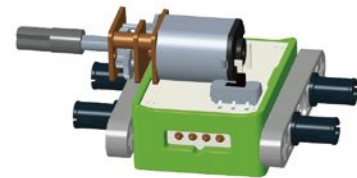

46



47



48



49



50



51



52

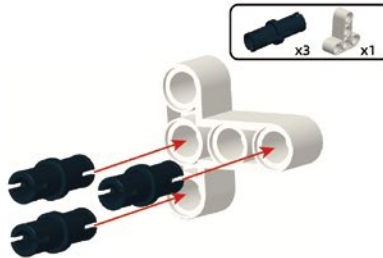

53



54



55

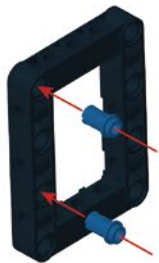

56

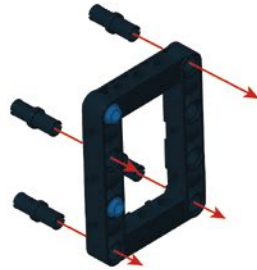

57

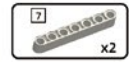
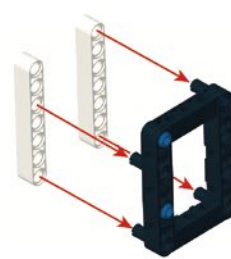

58



59



60



61

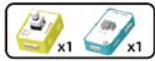

62



63



6. Game Interactions

Invite your families or friends to experience your fitness expert project together!

- **Game Rules :**

1. 2 or more people needed. Each of them holds a dumbbell or something heavy;
2. Start the fitness expert and follow it's movements to exercise, and compete who can last longer!

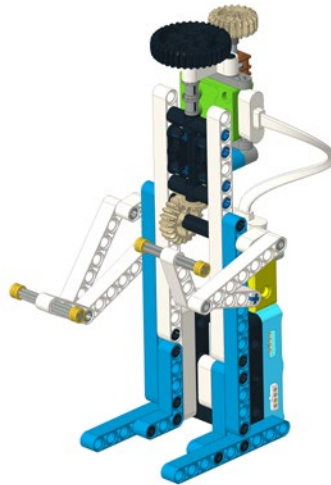

7. Brainstorming

A switch, DC motor and different Lego structure parts are used in this project. There are many other ways to get fit, such as running, push-ups, sit-ups, skipping rope, playing basketball, etc. Try designing a push-up or running robot with the existing supplies and the same transmission structure.

Quadruped Robot

1. Learning Goals:

1. Learn how the quadruped robot works
2. Know the walking way of the quadruped robot
3. Master how to build a quadruped robot

2. Supplies List:

• Electronic supplies:

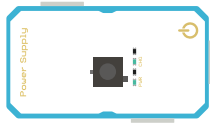

Medium Power Supply

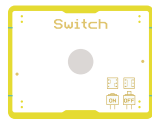

Switch

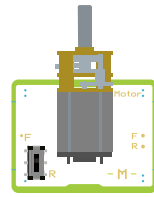

DC Motor



Magnetic Cable

• Structure Supplies:

Lego Structure Part (The complete Lego bar chart is on page 106, 107)

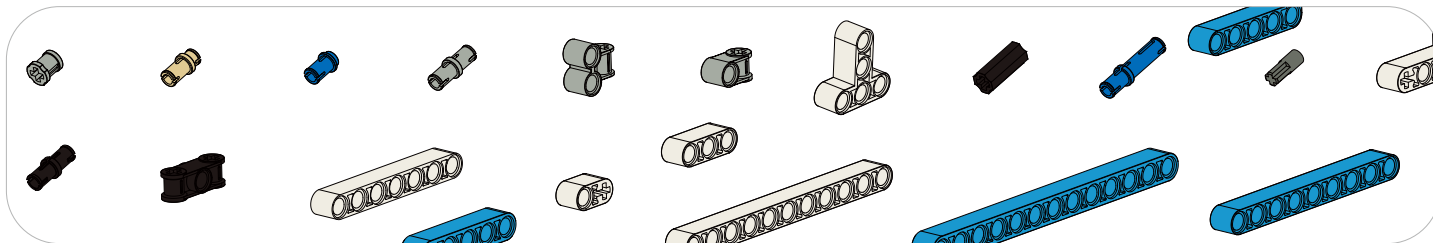

3. Application

With the rapid development of science and technology, various robots have begun to be widely used in daily life, such as sweeping robots at home, food delivery robots in restaurants. Quadruped robots are widely used in these fields like the military detection, scientific exploration, disaster rescue and life entertainment due to their stable structure and flexible movement ability.

Do you know how a quadruped robot works? It turns out that the quadruped robot uses the principle of "crank slider structure" to convert the rotating motion of the decelerating motor into a reciprocating swing motion that drives the legs to step. The connecting rod structure controls the four legs to simulate the gait law of animals for moving on.

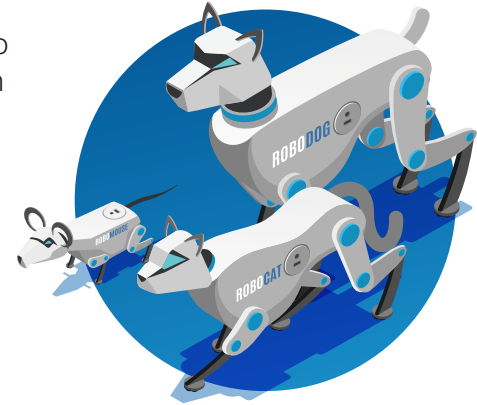

4. Knowledge Analysis

1. Circuit Connection: The quadruped robot is composed of a medium power supply, a switch and a DC motor. Connect them according to the following circuit diagram:



2. How the Circuit Works: Turn on the power, press the self-locking switch, and the circuit is turned on. The motor starts to rotate, driving the gear to move, and then the quadruped robot starts to move.

5. Model Building

• Build a quadruped robot

01

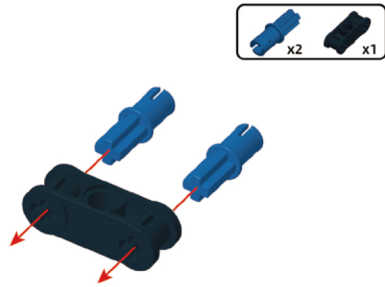

02

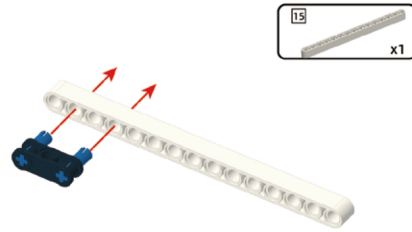

03



04

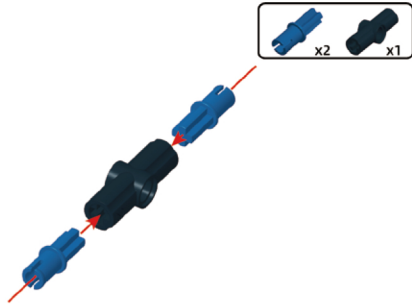

05

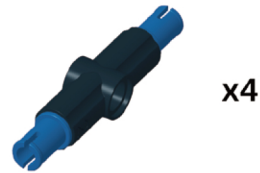

06

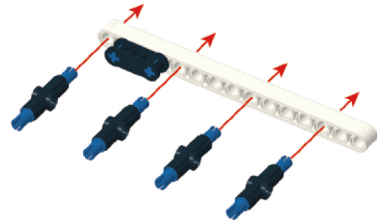

07



08

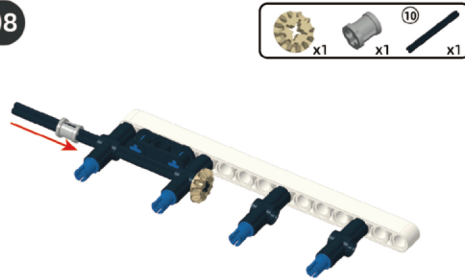

09

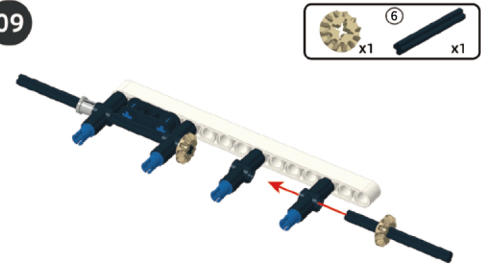

10



11

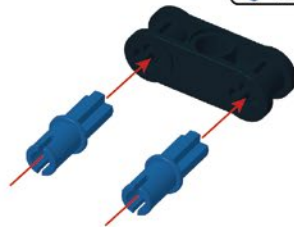

12



13

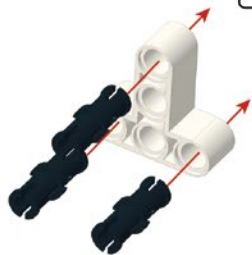

14



15



16



17



18



19



20



21



22



23



24



25

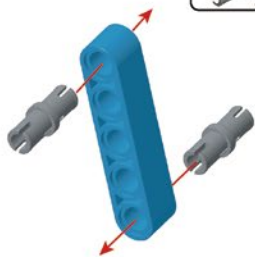
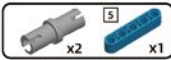

26



27

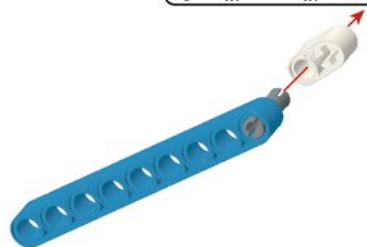

28



29

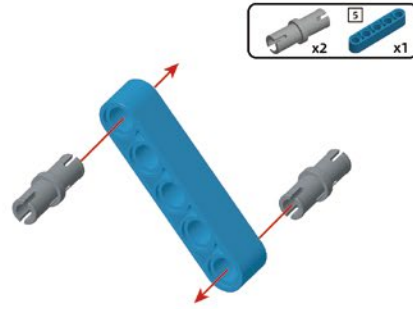

30

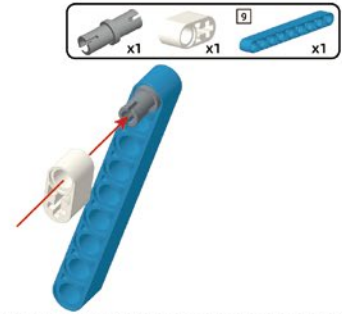

31



32



33

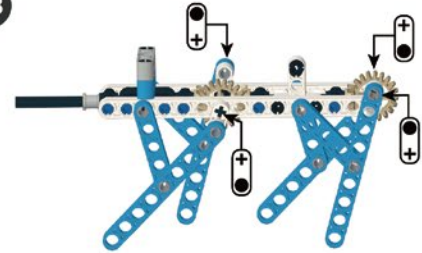

34



35

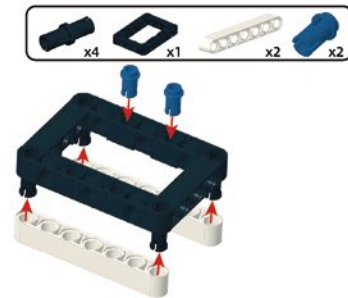

36



37



38



39

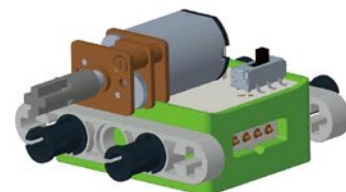

40



41



42

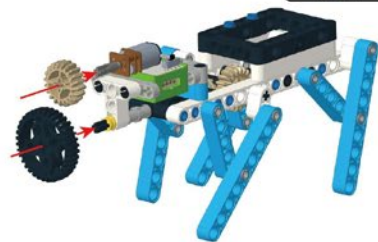

43



44

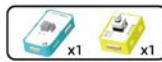

45



46



47

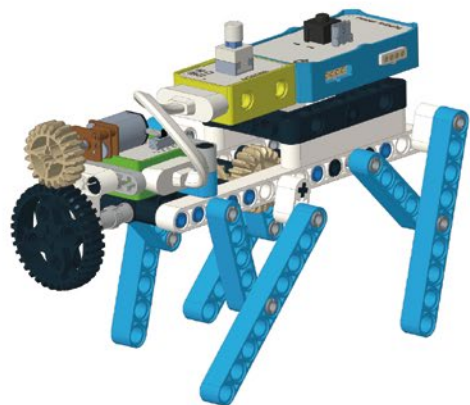

6. Game Interactions

Invite your families or friends to play the quadruped robot racing game!

- **Game Rules :**

1. 2 or more players take turns to compete;
2. The player puts the quadruped robot at the starting point and straightens the direction of the robot;
3. Turn on the power and the switch, and compete whose robot can run to the destination in the shortest time.



7. Brainstorming

We focused on learning the knowledge of quadruped robots in this project. There are many bionic robots such as bionic reptiles, bionic fish, robot dogs, bionic birds, etc.

You can also use the existing supplies to design a bionic robot independently, such as a bionic dog, a bionic bird or a bionic penguin.

Lift

1. Learning Goals:

1. Learn how to use the 315MHz remote control
2. Learn how a lift works
3. Master how to build the lift structure

2. Supplies List:

• Electronic supplies:

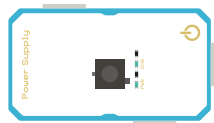

Medium Power Supply

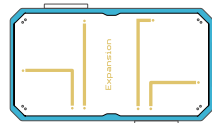

Expansion

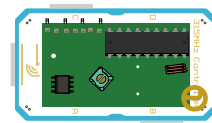

315MHz Remote Control and Receiver

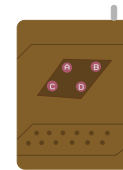

Magnetic Cable

• Structure Supplies:

Lego Structure Part (The complete Lego bar chart is on page 106, 107)

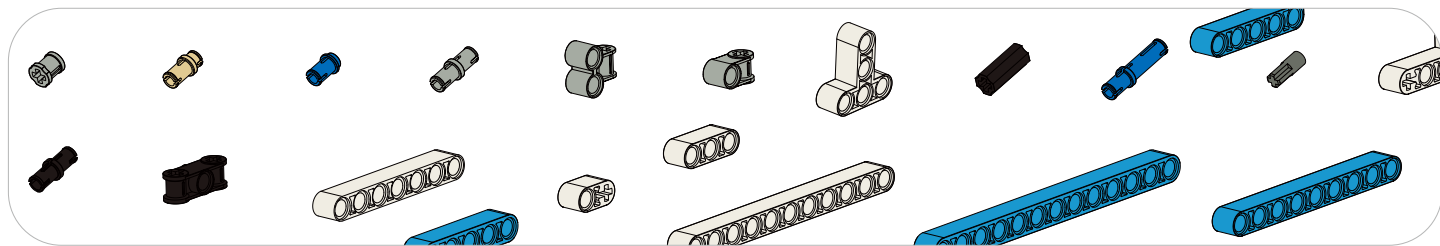

3. Application

Lift is an equipment which can rise and down. It can help us to manage to work high above the ground and lift heavy load to high altitude in a safe and easy way.

Then do you know how the lift works? The lift realizes the function of going up and down through a scissor connecting rod structure driven by a motor transmission. Now let's make a lift project.



4. Knowledge Analysis

1. Modules Introduction :

- **Expansion:** Aim to extend two parallel ports to two different directions which can help to fully use the ports and connect more modules.

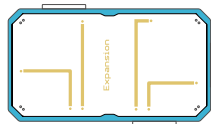

- **315MHz remote control and receiver:** The 315MHz Remote control has four keys which can send four different signals. After the receiver received the signal, it will control the related ports output signal to control the modules.

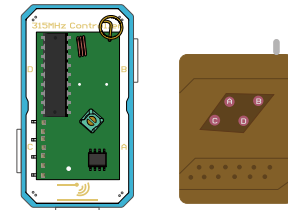

2. Circuit Connection: The lift is composed of a medium power supply, 315MHz remote control and receiver, an expansion and a DC motor. Here is the circuit diagram.

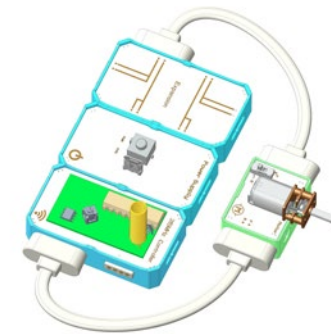

3. How the Circuit Works: Press the 315MHz remote control, and the receiver will receive the signals to control the motor to work. When button A pressed, the lift will rise and when button B pressed, the lift will go down .

5. Model Building

• Building a lift project

01

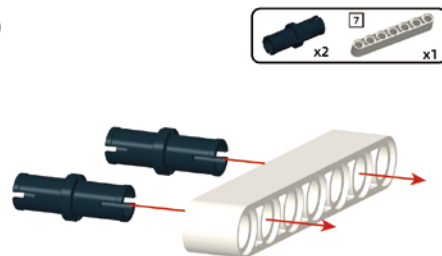

02

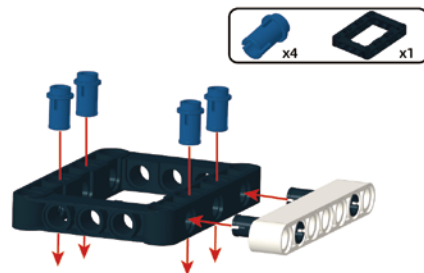

03

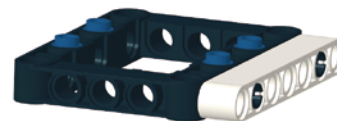

04

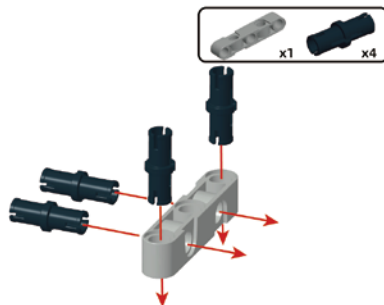

05

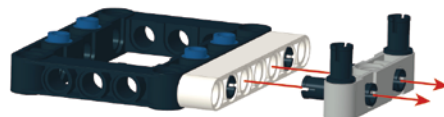

06

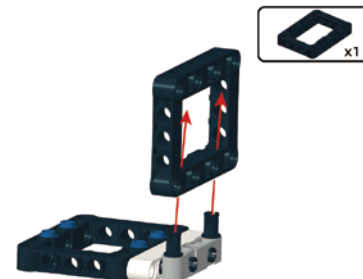

07



08

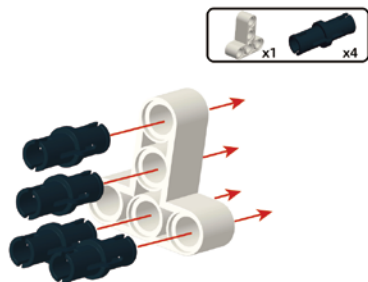

09

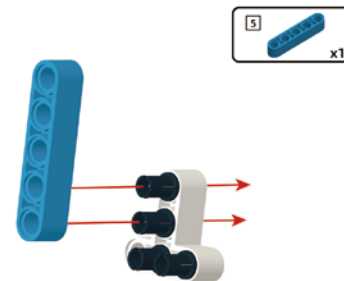

10

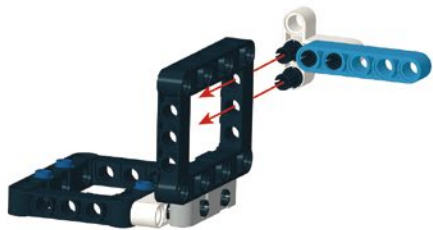

11



12



13



14



15

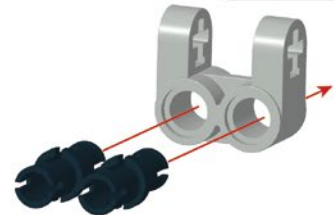

16



17

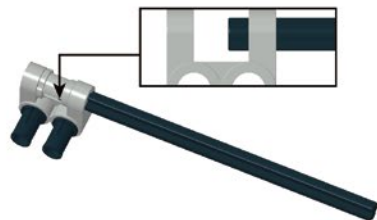

18



19



20

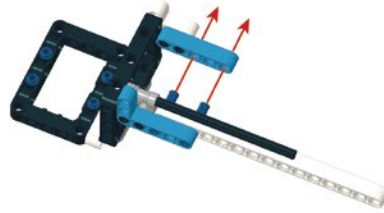

21



22



23



24



25

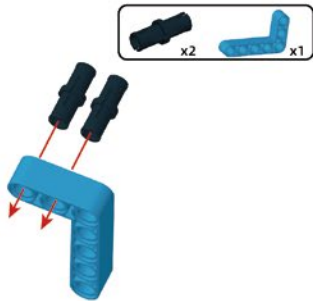

26

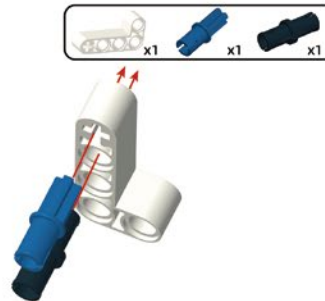

27



28



29



30

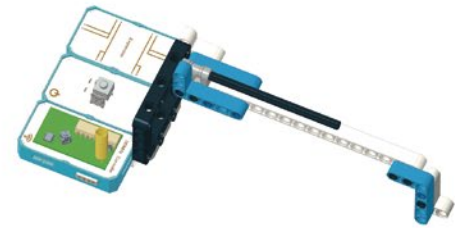

31

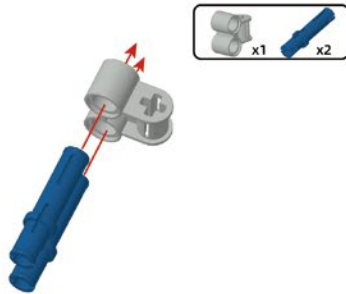

32

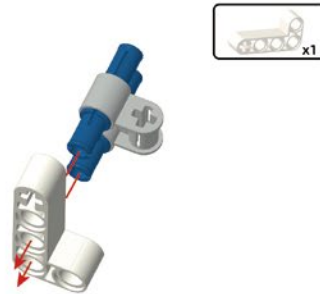

33



34

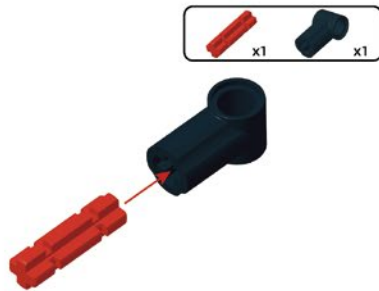

35



36



37



38



39

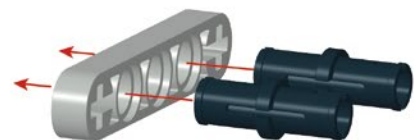

40

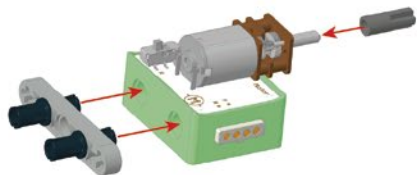

41



42

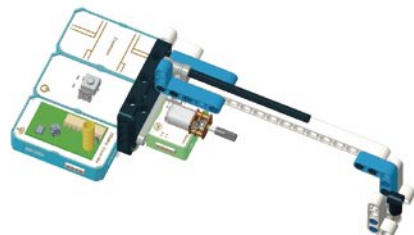

43

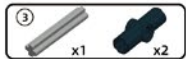

44

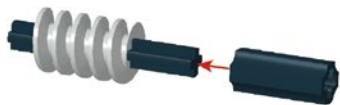

45



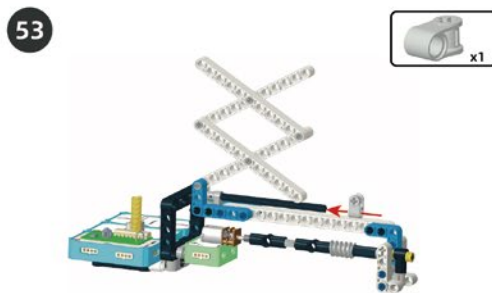
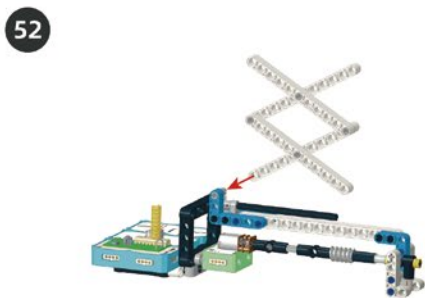
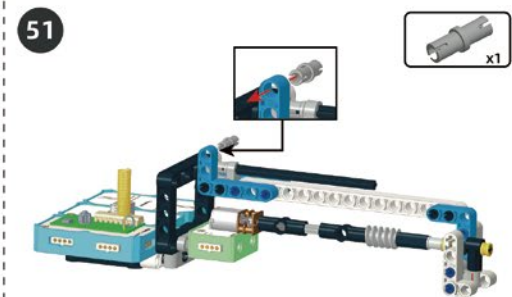
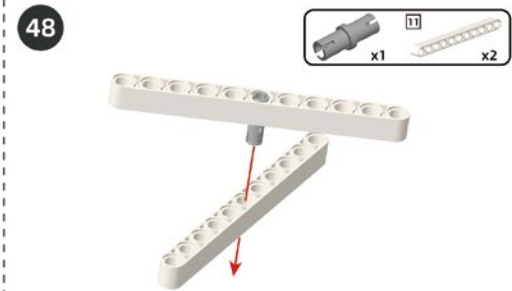
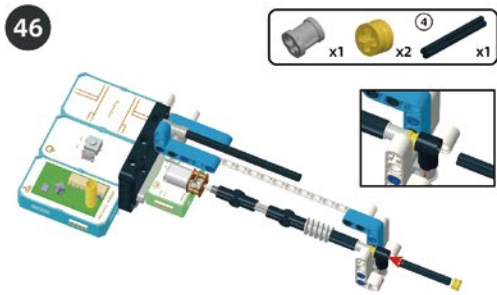

55



56



57



58

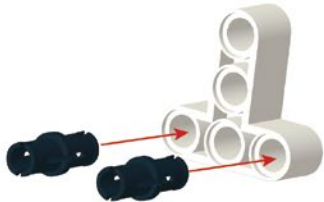

59

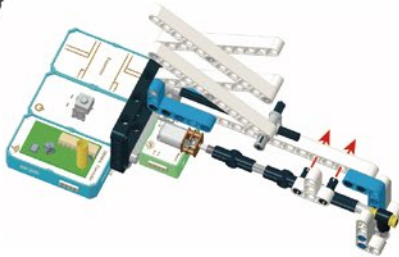

60

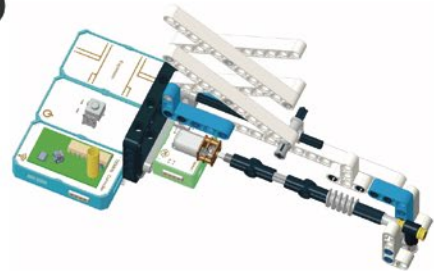

61



62



63

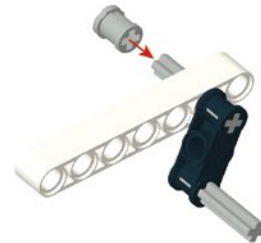

64



65

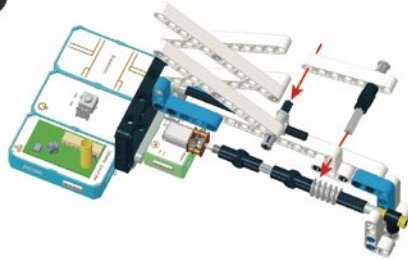

66

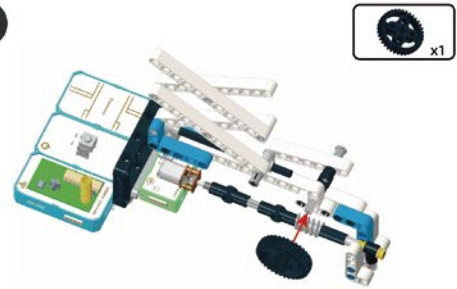

67

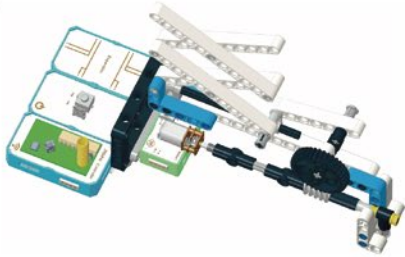

68

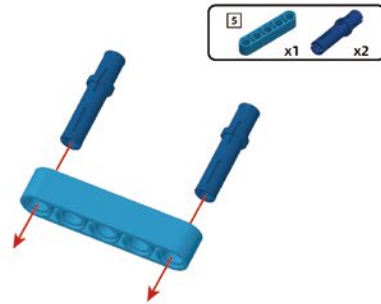

69

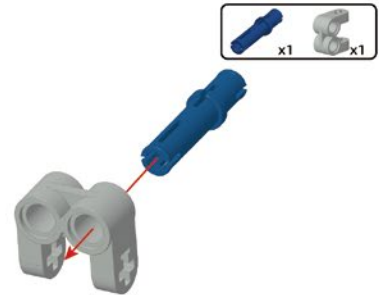

70

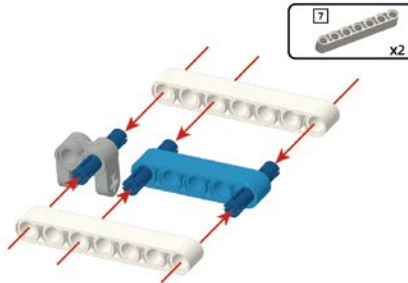

71



72

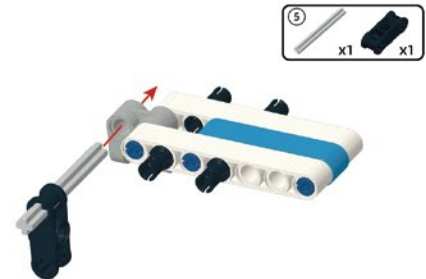

73

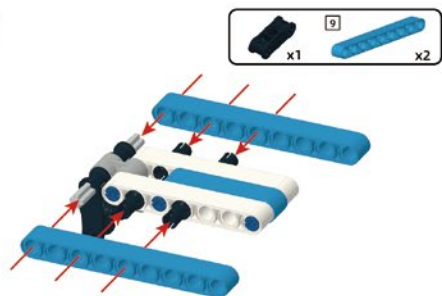

74



75

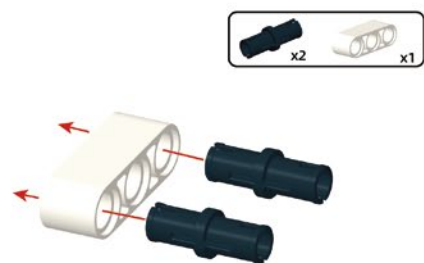

76



77



78

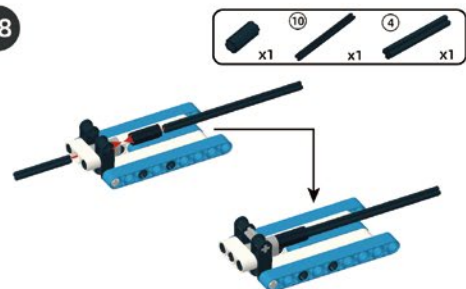

79

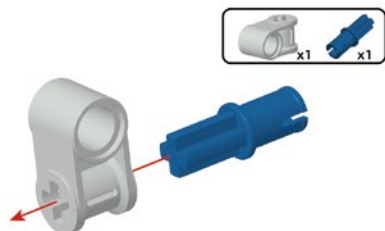

80



81



82



83



84



6. Game Interactions

Invite your families or friends to play the lift loading goods game!

• Game Rules :

1. Two or more players take turns to compete with each other. And during the games, player can use other electronic modules or other things as goods to be lifted;
2. Only ten seconds for players to pile goods on the lift. Once loading finished, start the game;
3. The one who loading the most goods in the most stable status will win the game.



7. Brainstorming

In this project, we mainly learned the use of the 315MHz remote control and receiver, and how to connect the expansion modules in a circuit. In our daily life, the wireless remote control technology is widely used like the radio-controlled toy car, the cars remote key and so on.

You can also design a totally new product independently with the existing kits such as a remote small toy car, a remote-controlled fan or a door.

Skiing Robot

1. Learning Goals:

1. Know the working principle of skiing robot
2. Master how to build a skiing robot

2. Supplies List:

• Electronic supplies:

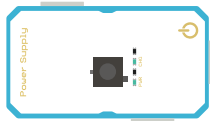

Medium Power Supply

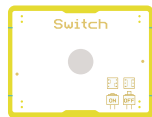

Switch

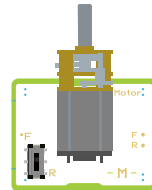

DC Motor



Magnetic Cable

• Structure Supplies:

Lego Structure Part (The complete Lego bar chart is on page 106, 107)

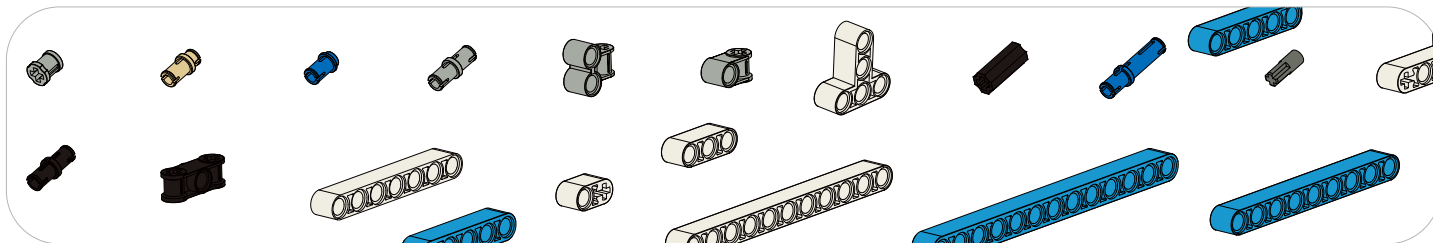

3. Application

Skiing is a very exciting and funny sports game, which is deeply loved by many people. When holding the poles and stepping on the skis, you can slide on snow surface quickly.

However, do you know the working principle of skiing? It actually takes advantage of the less friction between skis and ice surface, and uses the poles to provide power or resistance, then we can control the speed and direction while skiing.

Now, let's do a skiing robot together!



4. Knowledge Analysis

1. Circuit Connection: Skiing robot is composed of medium power supply, switch and DC motor. Please connect them according to following circuit diagram :

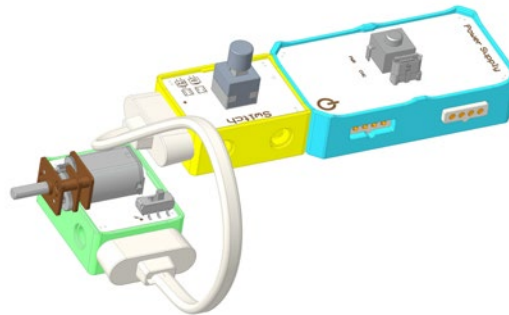

2. How the Circuit Works: When the power is turned on and the switch is pressed, the DC motor starts to rotate and make the skiing robot move forward. When the switch is turned off, the skiing robot stops moving.

5. Model Building

• Build skiing robot

01

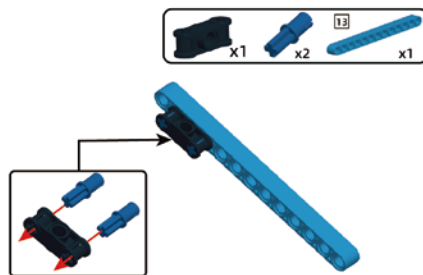

02

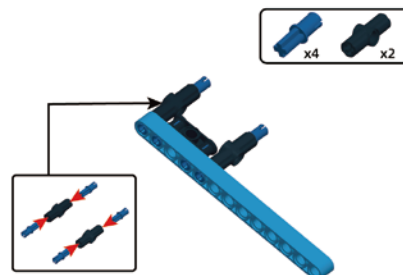

03

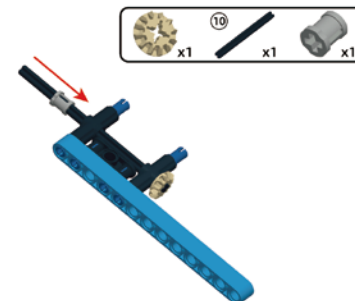

04

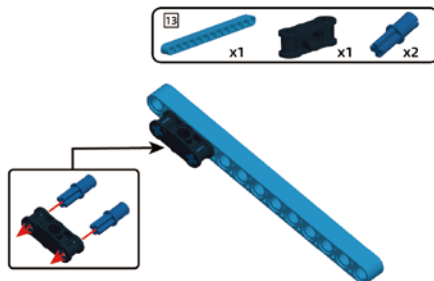

05

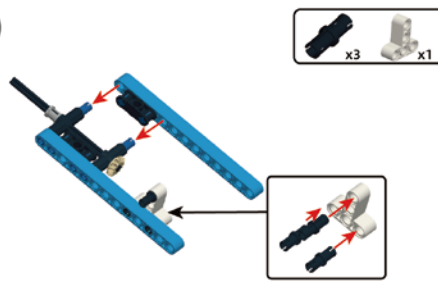

06



07

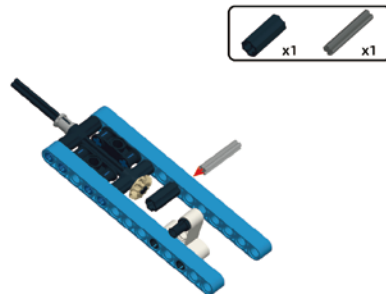

08

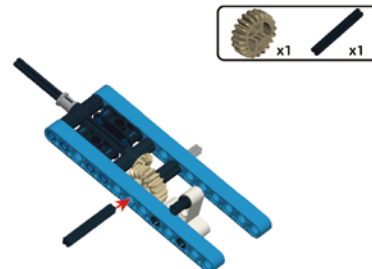

09

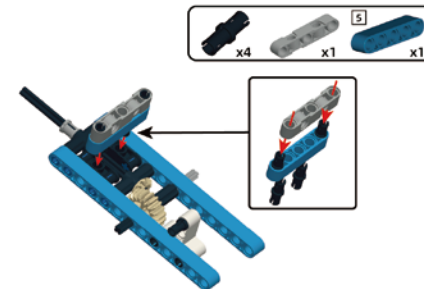

10

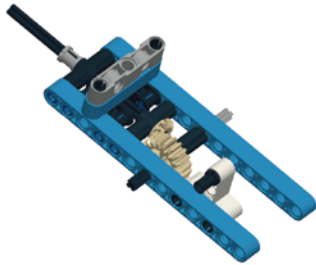

11

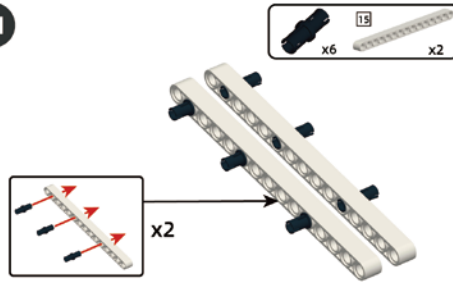

12

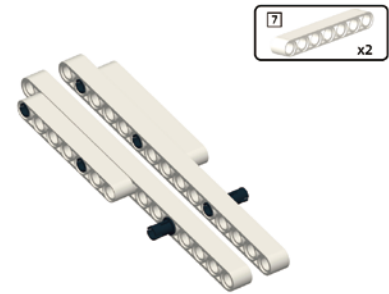

13

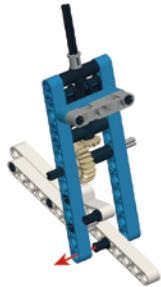

14

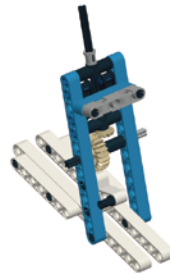

15

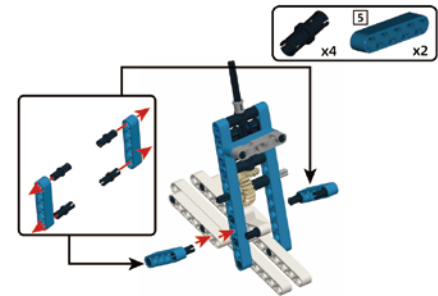

16

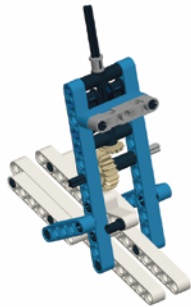

17

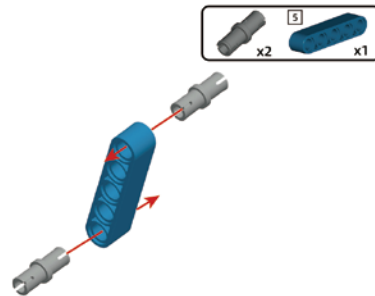

18

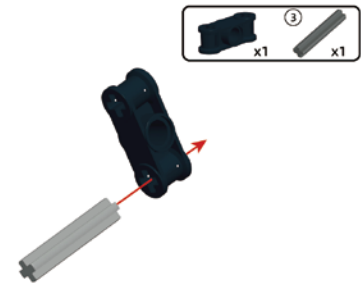

19

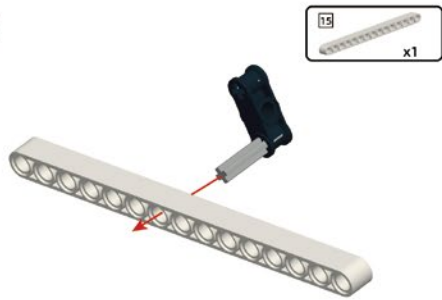

20

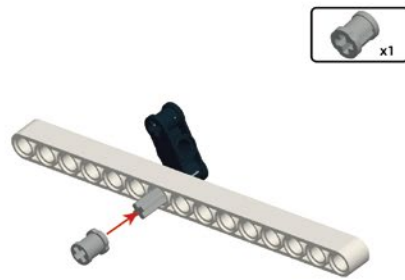

21

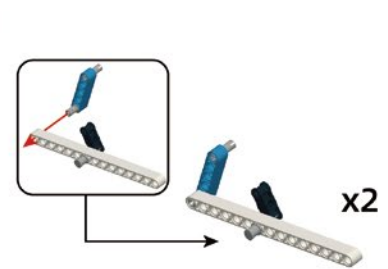

22

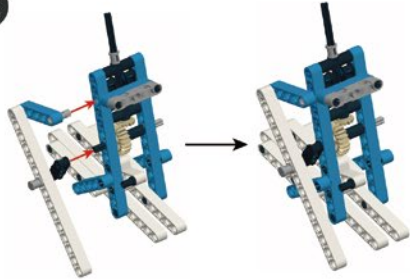

23

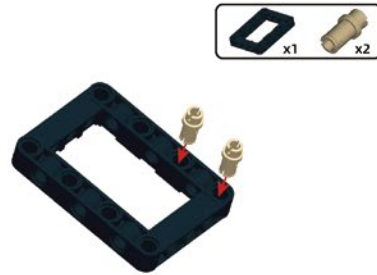

24

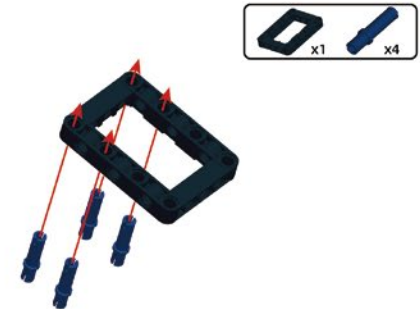

25



26

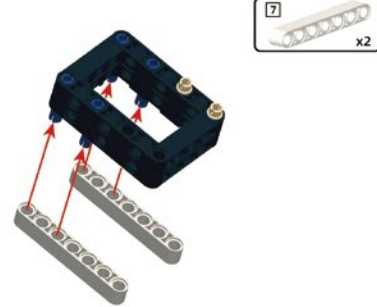

27



28



29

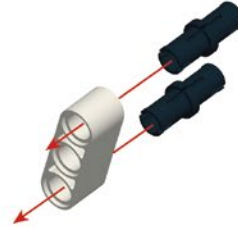

30

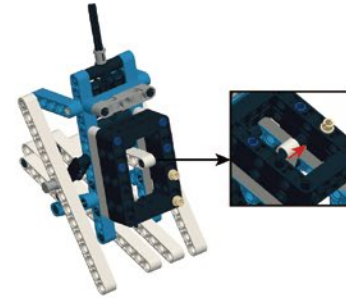

31



32



33



34



35

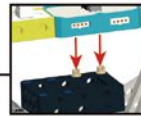
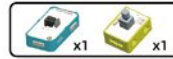

36



6. Game Interactions

Let's invite your families and friends to experience the fun of skiing robot!

- **Game Rules:**



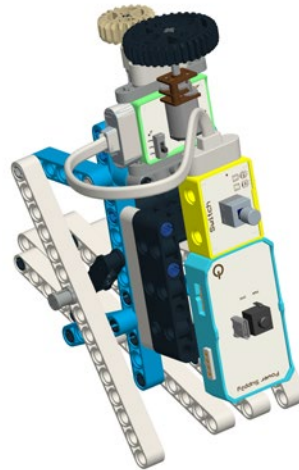

1. Two or more players race by turns, and choose the different smoothness planes to begin an equidistant skiing competition.
2. Put the skiing robot on the different surface and begin to race, then time, and find out which surface could make the robot slide to the destination firstly.







7. Brainstorming

In this project, we mainly use switch, DC motor and different lego structure parts to build a skiing robot. You can change the switch to other sensors, and check what will happen. Of course, there are many other robots can be built except skiing robot, such as boating robot, dancing robot, fencing robot and so on.

Parts list

 x5	 x6	 x4	 x4	 x1
 x2	 x1	 x12	 x35	 x12
 x16	 x4	 x2	 x1	 x2
 x4	 x1	 x3	 x3	 x3 ^②
 x4 ^③	 x4 ^④	 x3 ^⑤	 x1 ^⑥	 x2 ^⑩
 x2	 x2	 x2	 x1	 x3

Parts list

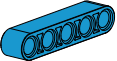
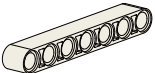
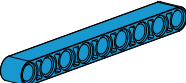
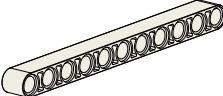
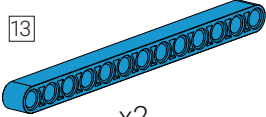
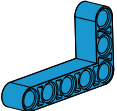
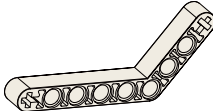
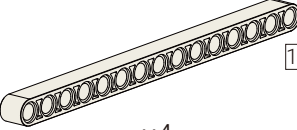
 x4	 x3	 x4	 x2	 x2
 x7	 x4	 x4	 x4	 x2
 x4	 x2	 x4		

5. Common technical problems

1. When the power module is switched on, the indicator light is not on.

- Use USB or A power adapter to charge the power module.

2. What if the module does not respond?

- Check whether the input module is on the left side of the output module, and connect the module correctly according to the connection diagram of the module.
- Adjust the position of the power module and check whether one side of the power module has bad contact.
- Replace the input and output modules with normal input and output modules to confirm whether there is a problem in one of the modules.

