

8-Mbit (1M x 8) Static RAM

Features

- **High speed**
— $t_{AA} = 10 \text{ ns}$
- **Low active power**
— $I_{CC} = 110 \text{ mA}$
- **Low CMOS standby power**
— $I_{SB2} = 20 \text{ mA}$
- **2.0V data retention**
- **Automatic power-down when deselected**
- **TTL-compatible inputs and outputs**
- **Easy memory expansion with \overline{CE} and \overline{OE} features**
- **Available in lead-free 36-ball FBGA and 44-pin TSOP II ZS44 packages**

Functional Description^[1]

The CY7C1059DV33 is a high-performance CMOS Static RAM organized as 1M words by 8 bits. Easy memory expansion is provided by an active LOW Chip Enable (\overline{CE}), an active LOW Output Enable (\overline{OE}), and tri-state drivers. Writing to the device is accomplished by taking Chip Enable (\overline{CE}) and Write Enable (\overline{WE}) inputs LOW. Data on the eight I/O pins (I/O_0 through I/O_7) is then written into the location specified on the address pins (A_0 through A_{19}).

Reading from the device is accomplished by taking Chip Enable (\overline{CE}) and Output Enable (\overline{OE}) LOW while forcing Write Enable (\overline{WE}) HIGH. Under these conditions, the contents of the memory location specified by the address pins will appear on the I/O pins.

The eight input/output pins (I/O_0 through I/O_7) are placed in a high-impedance state when the device is deselected (\overline{CE} HIGH), the outputs are disabled (\overline{OE} HIGH), or during a Write operation (\overline{CE} LOW, and \overline{WE} LOW).

The CY7C1059DV33 is available in 36-ball FBGA and 44-pin TSOP II package with center power and ground (revolutionary) pinout.

Logic Block Diagram

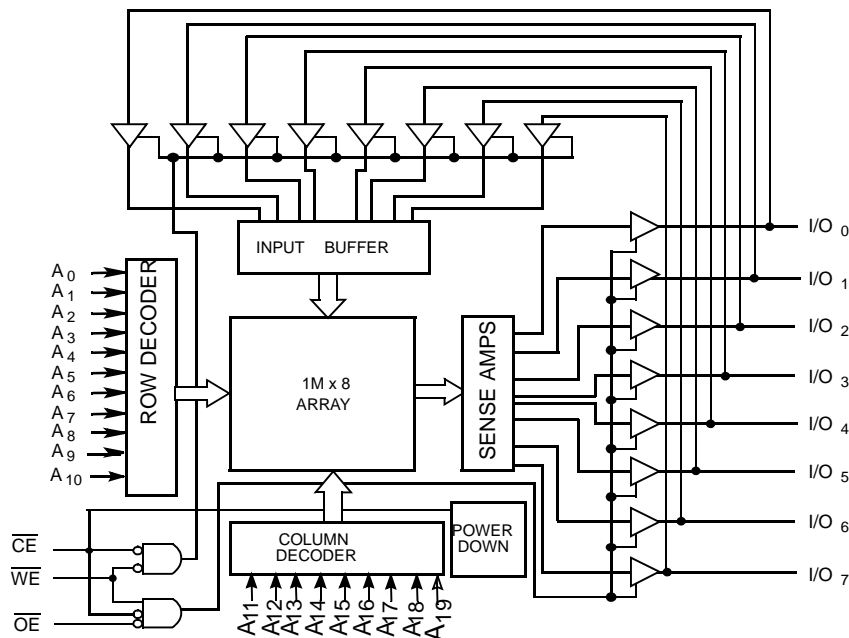

Note:

1. For guidelines on SRAM system design, please refer to the 'System Design Guidelines' Cypress application note, available on the internet at www.cypress.com.

Pin Configuration

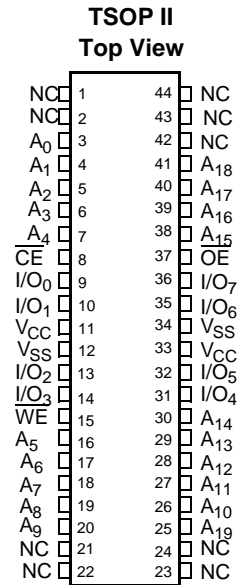
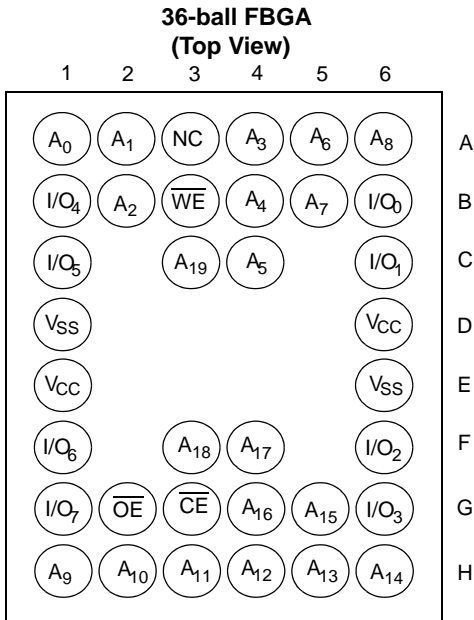

Selection Guide

	-10	Unit
Maximum Access Time	10	ns
Maximum Operating Current	110	mA
Maximum CMOS Standby Current	20	mA



Maximum Ratings

(Above which the useful life may be impaired. For user guidelines, not tested.)

Storage Temperature -65°C to +150°C
 Ambient Temperature with Power Applied..... -55°C to +125°C
 Supply Voltage on V_{CC} to Relative GND^[2] -0.5V to +4.6V
 DC Voltage Applied to Outputs in High-Z State^[2] -0.3V to V_{CC} + 0.3V

DC Input Voltage^[2] -0.3V to V_{CC} + 0.3V
 Current into Outputs (LOW)..... 20 mA
 Static Discharge Voltage..... >2001V (per MIL-STD-883, Method 3015)
 Latch-up Current..... >200 mA

Operating Range

Range	Ambient Temperature	V _{CC}
Industrial	-40°C to +85°C	3.3V ± 0.3V

Electrical Characteristics Over the Operating Range

Parameter	Description	Test Conditions	-10		Unit
			Min.	Max.	
V _{OH}	Output HIGH Voltage	V _{CC} = Min., I _{OH} = -4.0 mA	2.4		V
V _{OL}	Output LOW Voltage	V _{CC} = Min., I _{OL} = 8.0 mA		0.4	V
V _{IH}	Input HIGH Voltage		2.0	V _{CC} + 0.3	V
V _{IL}	Input LOW Voltage ^[2]		-0.3	0.8	V
I _{IX}	Input Leakage Current	GND ≤ V _I ≤ V _{CC}	-1	+1	μA
I _{OZ}	Output Leakage Current	GND ≤ V _{OUT} ≤ V _{CC} , Output Disabled	-1	+1	μA
I _{CC}	V _{CC} Operating Supply Current	V _{CC} = Max., f = f _{MAX} = 1/t _{RC}	100 MHz	110	mA
			83 MHz	100	
			66 MHz	90	
			40 MHz	80	
I _{SB1}	Automatic CE Power-down Current —TTL Inputs	Max. V _{CC} , CE ≥ V _{IH} , V _{IN} ≥ V _{IH} or V _{IN} ≤ V _{IL} , f = f _{MAX}		40	mA
I _{SB2}	Automatic CE Power-down Current —CMOS Inputs	Max. V _{CC} , CE ≥ V _{CC} - 0.3V, V _{IN} ≥ V _{CC} - 0.3V, or V _{IN} ≤ 0.3V, f = 0		20	mA

Capacitance^[3]

Parameter	Description	Test Conditions	Max.	Unit
C _{IN}	Input Capacitance	T _A = 25°C, f = 1 MHz, V _{CC} = 3.3V	16	pF
C _{OUT}	I/O Capacitance		16	pF

Thermal Resistance^[3]

Parameter	Description	Test Conditions	FBGA	TSOP II	Unit
θ _{JA}	Thermal Resistance (Junction to Ambient)	Still Air, soldered on a 3 × 4.5 inch, four-layer printed circuit board	TBD	TBD	°C/W
θ _{JC}	Thermal Resistance (Junction to Case)		TBD	TBD	°C/W

Notes:

- V_{IL} (min.) = -2.0V and V_{IH} (max.) = V_{CC} + 2V for pulse durations of less than 20 ns.
- Tested initially and after any design or process changes that may affect these parameters.

AC Test Loads and Waveforms^[4]

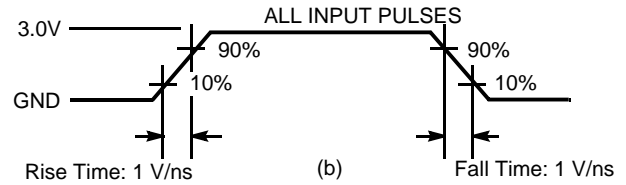
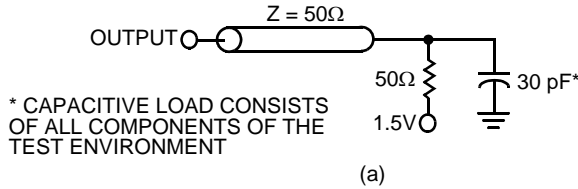

High-Z characteristics:

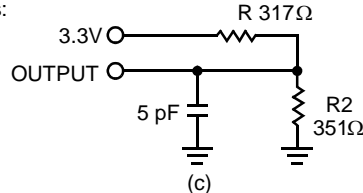

AC Switching Characteristics^[5] Over the Operating Range

Parameter	Description	-10		Unit
		Min.	Max.	
Read Cycle				
$t_{power}^{[6]}$	V_{CC} (typical) to the first access	100		μs
t_{RC}	Read Cycle Time	10		ns
t_{AA}	Address to Data Valid		10	ns
t_{OHA}	Data Hold from Address Change	3		ns
t_{ACE}	\overline{CE} LOW to Data Valid		10	ns
t_{DOE}	\overline{OE} LOW to Data Valid		5	ns
t_{LZOE}	\overline{OE} LOW to Low-Z	0		ns
t_{HZOE}	\overline{OE} HIGH to High-Z ^[7, 8]		5	ns
t_{LZCE}	\overline{CE} LOW to Low-Z ^[8]	3		ns
t_{HZCE}	\overline{CE} HIGH to High-Z ^[7, 8]		5	ns
t_{PU}	\overline{CE} LOW to Power-up	0		ns
t_{PD}	\overline{CE} HIGH to Power-down		10	ns
Write Cycle^[9, 10]				
t_{WC}	Write Cycle Time	10		ns
t_{SCE}	\overline{CE} LOW to Write End	7		ns
t_{AW}	Address Set-up to Write End	7		ns
t_{HA}	Address Hold from Write End	0		ns
t_{SA}	Address Set-up to Write Start	0		ns
t_{PWE}	\overline{WE} Pulse Width	7		ns
t_{SD}	Data Set-up to Write End	5		ns
t_{HD}	Data Hold from Write End	0		ns
t_{LZWE}	\overline{WE} HIGH to Low-Z ^[8]	3		ns
t_{HZWE}	\overline{WE} LOW to High-Z ^[7, 8]		5	ns

Notes:

- AC characteristics (except High-Z) are tested using the load conditions shown in Figure (a). High-Z characteristics are tested for all speeds using the test load shown in Figure (c).
- Test conditions assume signal transition time of 3 ns or less, timing reference levels of 1.5V, input pulse levels of 0 to 3.0V.
- t_{POWER} gives the minimum amount of time that the power supply should be at stable, typical V_{CC} values until the first memory access can be performed.
- t_{HZOE} , t_{HZCE} , and t_{HZWE} are specified with a load capacitance of 5 pF as in part (d) of AC Test Loads. Transition is measured when the outputs enter a high impedance state.
- At any given temperature and voltage condition, t_{HZCE} is less than t_{LZCE} , t_{HZOE} is less than t_{LZOE} , and t_{HZWE} is less than t_{LZWE} for any given device.
- The internal Write time of the memory is defined by the overlap of \overline{CE} LOW, and \overline{WE} LOW. \overline{CE} and \overline{WE} must be LOW to initiate a Write, and the transition of either of these signals can terminate the Write. The input data set-up and hold timing should be referenced to the leading edge of the signal that terminates the Write.
- The minimum Write cycle time for Write Cycle No. 3 (\overline{WE} controlled, \overline{OE} LOW) is the sum of t_{HZWE} and t_{SD} .

Data Retention Characteristics Over the Operating Range

Parameter	Description	Conditions ^[11]	Min.	Max.	Unit
V_{DR}	V_{CC} for Data Retention		2.0		V
I_{CCDR}	Data Retention Current	$V_{CC} = V_{DR} = 2.0V$, $CE \geq V_{CC} - 0.3V$, $V_{IN} \geq V_{CC} - 0.3V$ or $V_{IN} \leq 0.3V$		20	mA
$t_{CDR}^{[3]}$	Chip Deselect to Data Retention Time		0		ns
$t_R^{[12]}$	Operation Recovery Time		t_{RC}		ns

Data Retention Waveform

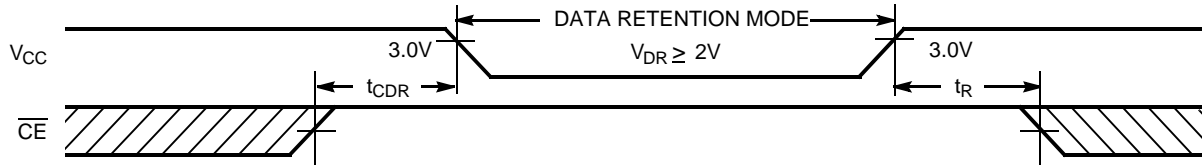

Switching Waveforms

Read Cycle No. 1^[13, 14]

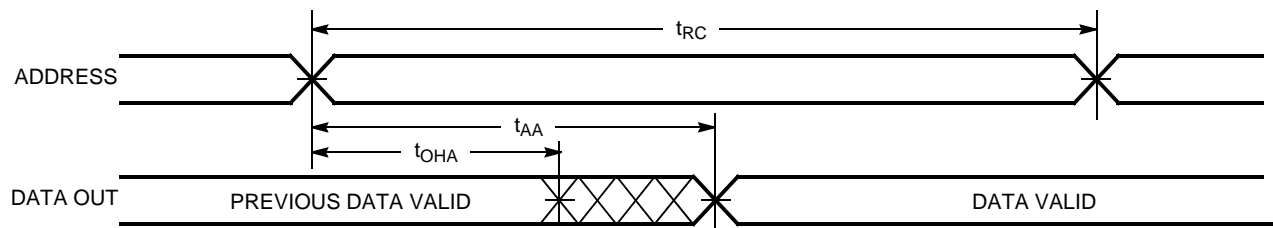

Read Cycle No. 2 (OE Controlled)^[14, 15]

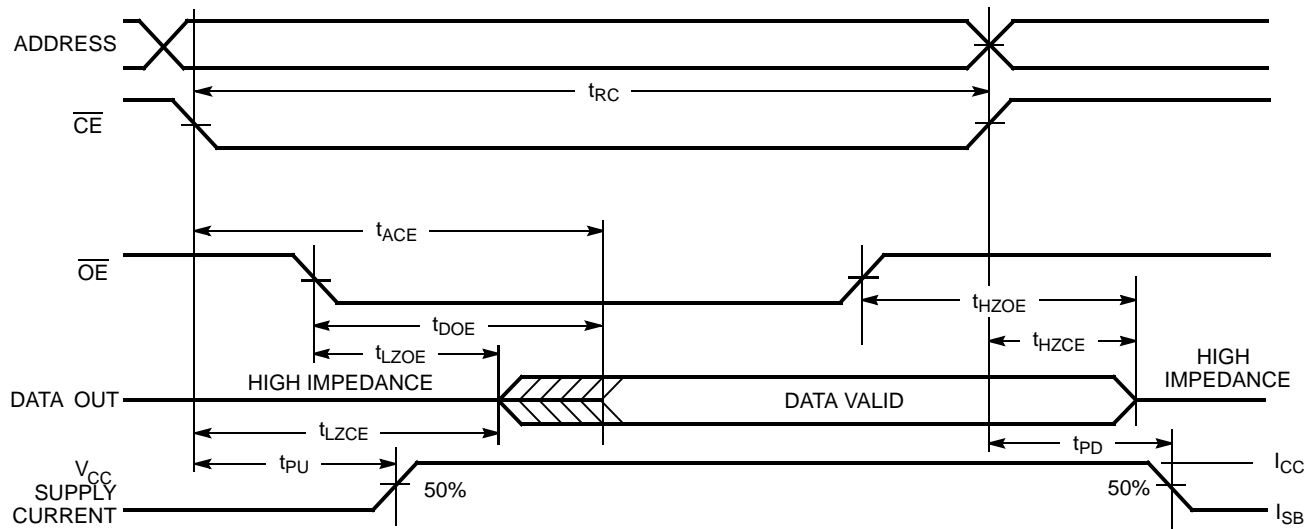

Notes:

- 11. No inputs may exceed $V_{CC} + 0.3V$
- 12. Full device operation requires linear V_{CC} ramp from V_{DR} to $V_{CC(min.)} \geq 50 \mu s$ or stable at $V_{CC(min.)} \geq 50 \mu s$.
- 13. Device is continuously selected. $OE, CE = V_{IL}$.
- 14. WE is HIGH for Read cycle.
- 15. Address valid prior to or coincident with CE transition LOW.

Switching Waveforms(continued)

Write Cycle No. 1 (\overline{WE} Controlled, \overline{OE} HIGH During Write)^[16, 17]

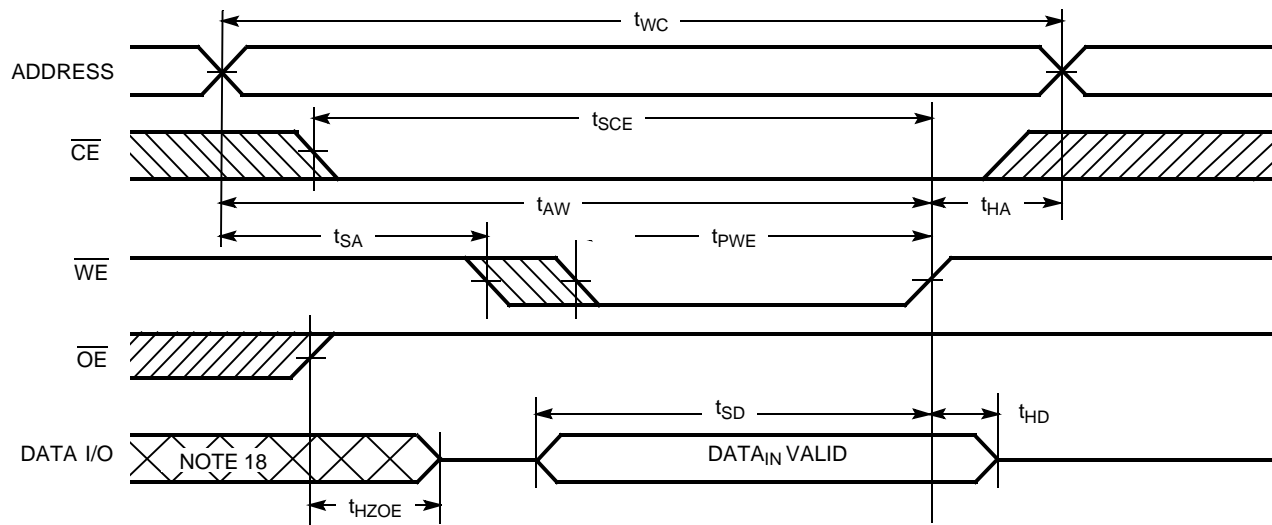

Write Cycle No. 2 (\overline{WE} Controlled, \overline{OE} LOW)^[17]

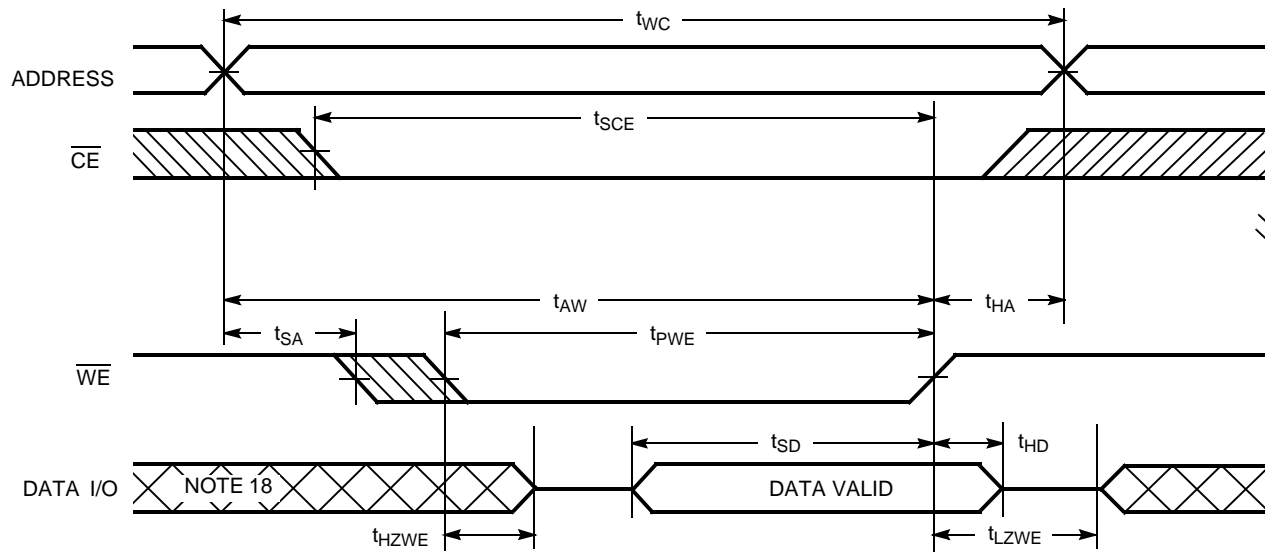

Notes:

- 16. Data I/O is high-impedance if $\overline{OE} = V_{IH}$.
- 17. If \overline{CE} goes HIGH simultaneously with \overline{WE} going HIGH, the output remains in a high-impedance state.
- 18. During this period the I/Os are in the output state and input signals should not be applied.

Truth Table

\overline{CE}	\overline{OE}	\overline{WE}	I/O ₀ -I/O ₇	Mode	Power
H	X	X	High-Z	Power-down	Standby (I _{SB})
L	L	H	Data Out	Read	Active (I _{CC})
L	X	L	Data In	Write	Active (I _{CC})
L	H	H	High-Z	Selected, Outputs Disabled	Active (I _{CC})

Ordering Information

Speed (ns)	Ordering Code	Package Diagram	Package Type	Operating Range
10	CY7C1059DV33-10BAXI	51-85105	36-ball FBGA (Pb-Free)	Industrial
	CY7C1059DV33-10ZSXI	51-85087	44-pin TSOP II (Pb-Free)	

Please contact your local Cypress sales representative for availability of these parts.

Package Diagrams

36-Ball FBGA (7.00 mm x 8.5 mm x 1.2 mm) (51-85105)

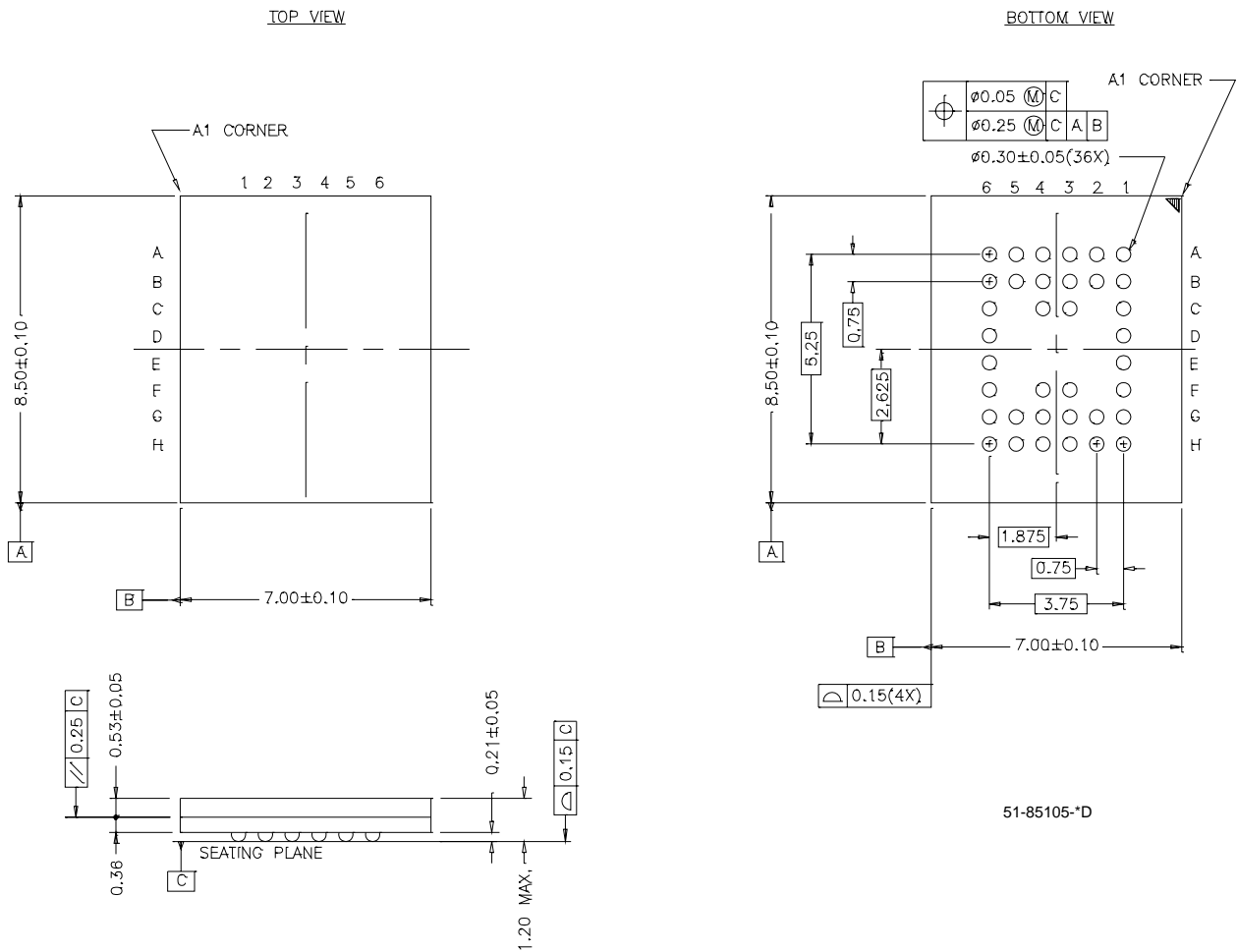

Package Diagrams (continued)

44-pin TSOP II (51-85087)

DIMENSION IN MM (INCH)
MAX
MIN

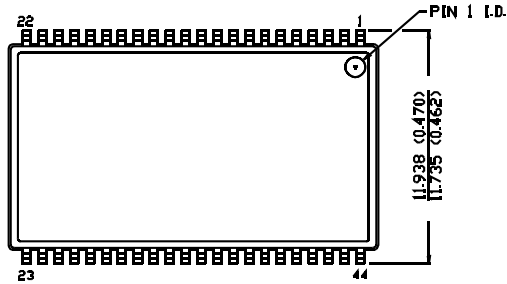

TOP VIEW

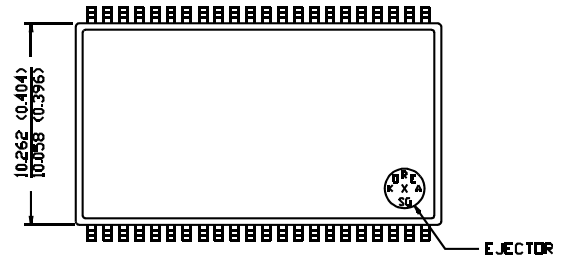

BOTTOM VIEW

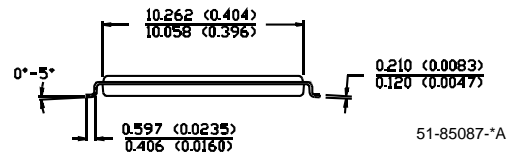
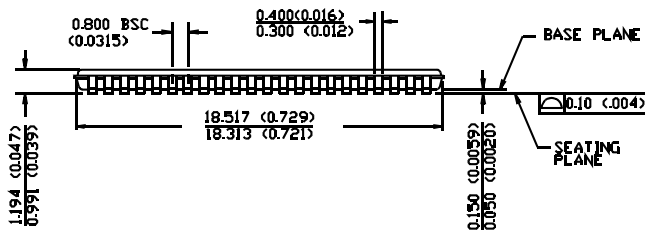

All product and company names mentioned in this document may be the trademarks of their respective holders.

Document History Page

Document Title: CY7C1059DV33 8-Mbit (1M x 8) Static RAM				
Document Number: 001-00061				
REV.	ECN NO.	Issue Date	Orig. of Change	Description of Change
**	342195	See ECN	PCI	New Data Sheet
*A	380574	See ECN	SYT	Redefined I _{CC} values for Com'l and Ind'l temperature ranges I _{CC} (Com'l): Changed from 110, 90 and 80 mA to 110, 100 and 95 mA for 8, 10 and 12 ns speed bins respectively I _{CC} (Ind'l): Changed from 110, 90 and 80 mA to 120, 110 and 105 mA for 8, 10 and 12 ns speed bins respectively Changed the Capacitance values from 8 pF to 10 pF on Page # 3
*B	485796	See ECN	NXR	Changed address of Cypress Semiconductor Corporation on Page# 1 from "3901 North First Street" to "198 Champion Court" Removed -8 and -12 Speed bins from product offering, Removed Commercial Operating Range option, Modified Maximum Ratings for DC input voltage from -0.5V to -0.3V and V _{CC} + 0.5V to V _{CC} + 0.3V Updated footnote #7 on High-Z parameter measurement Added footnote #11 Changed the Description of I _{IX} from Input Load Current to Input Leakage Current. Updated the Ordering Information table and Replaced Package Name column with Package Diagram.