

SPECIFICATION **CS126APT2C**
PACKAGE OUTLINES

ITEM	MATERIALS
Resin (mold)	Epoxy
Dice	Silicon
Lens color	Black

- Notes:
1. All dimensions are in millimeters (inches).
 2. Tolerance is $\pm 0.25\text{mm}$ (0.01") unless otherwise noted.
 3. Specifications are subject to change without notice.

Part Number	Chip Material	Color of Emission	Lens Type	Viewing Angle
CS126APT2C	Silicon	Phototransistor	Water Clear	140°

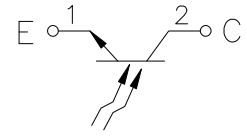
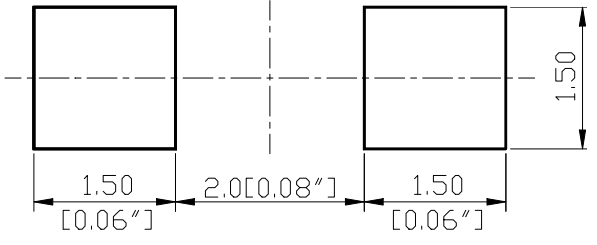
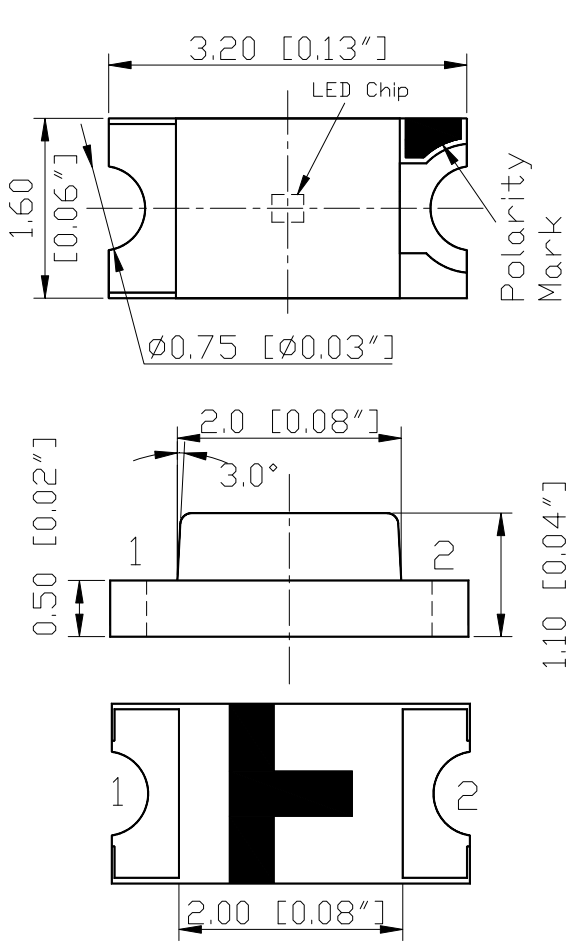

ChromeLED Corp. reserves the right to make changes at any time in order to supply the best product possible. The most current version of this document will always be available at: www.chromeled.com

ABSOLUTE MAXIMUM RATINGS
(TA=25°C)

Parameter	Symbol	Max Rating	Unit
Power Dissipation	P _D	100	mW
Emitter-Collector Breakdown Voltage	BV _{ECO}	5	V
Collector-Emitter Sustaining Voltage	V _{CE}	30	V
Operating Temperature Range	T _{OPR}	-40~+80	°C
Storage Temperature Range	T _{STG}	-40~+85	°C
IFP = Pulse Width ≤ 10 ms, Duty Ratio ≤1/10. Soldering Condition: 260 °C/ 5sec			

OPTICAL-ELECTRICAL CHARACTERISTICS
(TA=25°C)

Parameter	Symbol	Test Condition	Value			Unit
			Min	Typ	Max	
Collector-Emitter Breakdown Voltage	V _{CE}	I _C = 100 uA I _B =0	30	-	-	V
Collector-Emitter Saturation Voltage	V _{CE(SAT)}	I _C =2mA I _B =100uA	-	0.2	0.4	V
Collector Based Breakdown Voltage	BV _{CBO}	I _{CBO} =100 uA	5	7	-	uS
Dark Current	I _D	V _{CE} =20V	-	-	100	uA
Wavelength of Peak Sensitivity	λ _P	-	-	940	-	nm

*Tolerance of viewing angle: -10 / +5 deg.

 ChromeLED Corp. reserves the right to make changes at any time in order to supply the best product possible. The most current version of this document will always be available at: www.chromeled.com

OPTICAL CHARACTERISTIC CURVES

FIG.1 COLLECTOR DARK CURRENT VS. AMBIENT TEMPERATURE

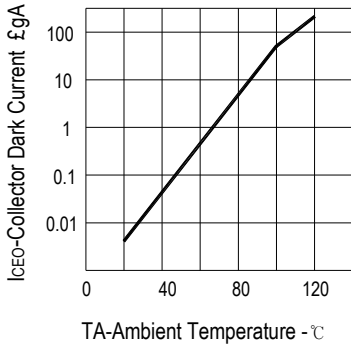

FIG.2 NORMALIZED COLLECTOR CURRENT VS. AMBIENT TEMPERATURE

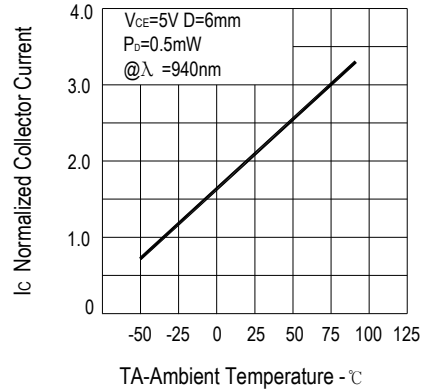

FIG.3 RISE AND FALL TIME VS. LOAD RESISTANCE

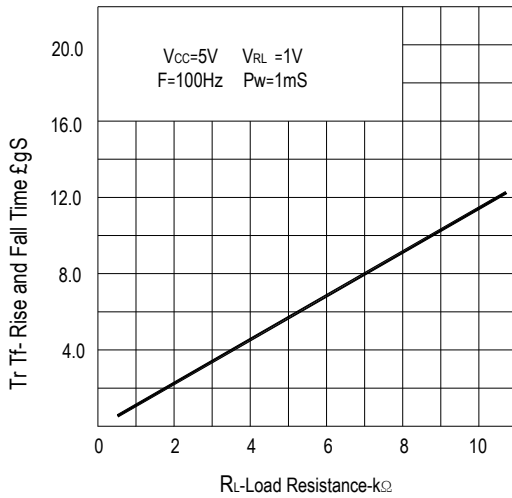
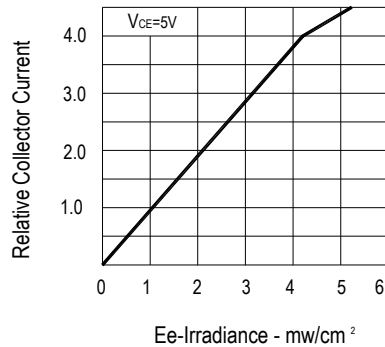
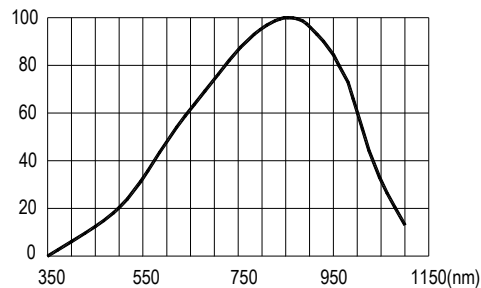

FIG.4 RELATIVE COLLECTOR CURRENT VS. IRRADIANCE



Relative Spectral Response (%)



ChromeLED Corp. reserves the right to make changes at any time in order to supply the best product possible. The most current version of this document will always be available at: www.chromeled.com

PACKAGING SPECIFICATION

- Feeding Direction

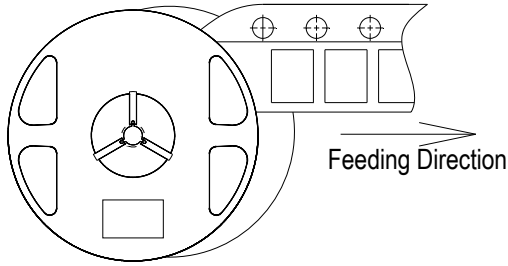

- Dimensions of Reel (Unit: mm)

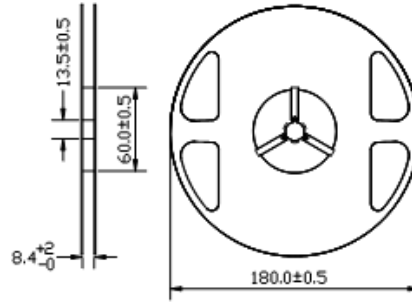

- Dimensions of Tape (Unit: mm)

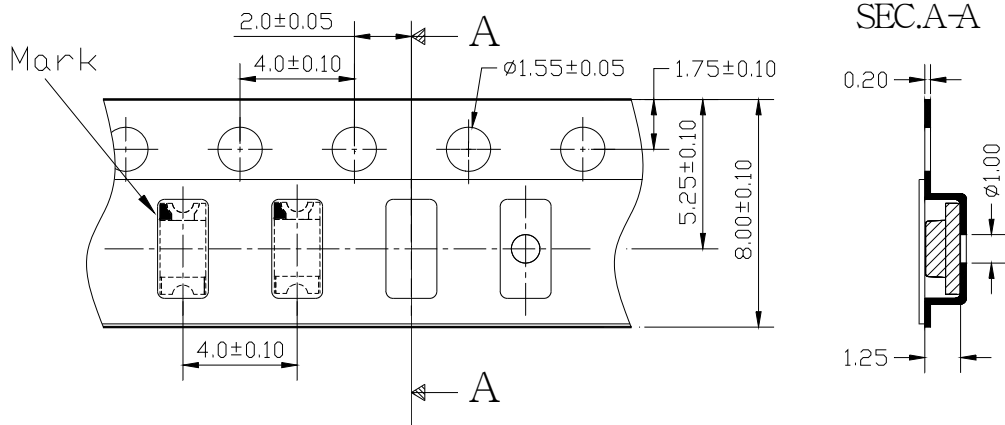

- Arrangement of Tape

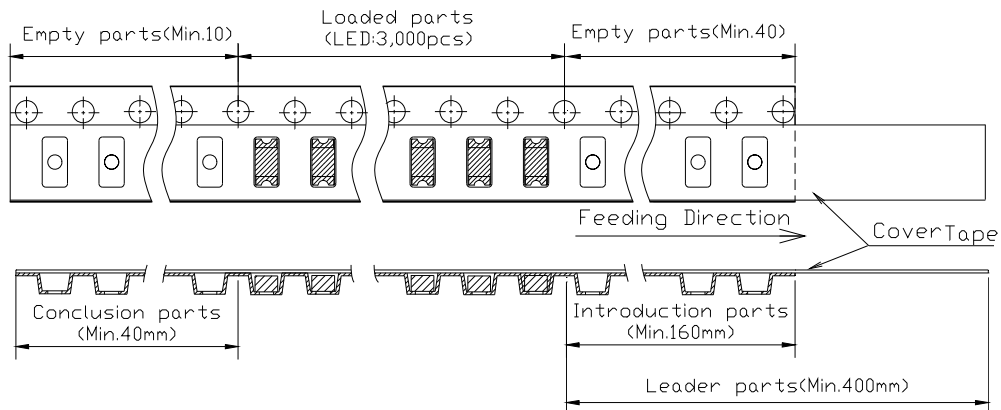

Notes:

1. Empty component pockets are sealed with top cover tape;
2. The maximum number of missing lamps is two;
3. The cathode is oriented towards the tape sprocket hole in accordance with ANSI/EIA RS-481 specifications.
4. 3,000 pcs/Reel



ChromeLED Corp. reserves the right to make changes at any time in order to supply the best product possible. The most current version of this document will always be available at: www.chromeled.com

SOLDERING CONDITIONS

REFLOW PROFILE

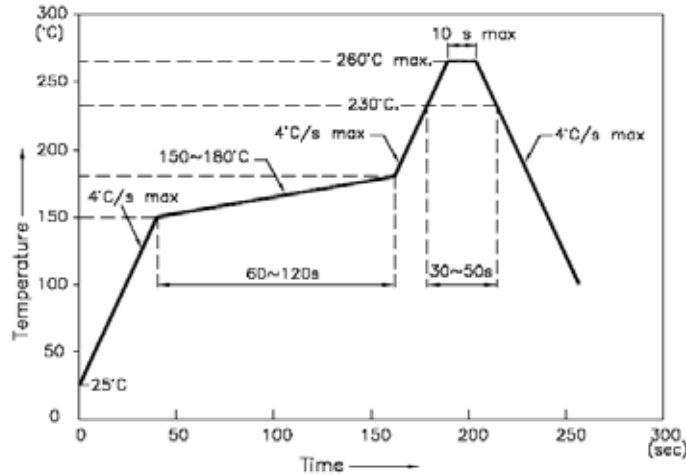

1. We recommend the reflow temperature 245°C (± 5 °C). The maximum soldering temperature should be limited to 260 °C.
 2. Don't cause stress to the epoxy resin while it is exposed to high temperature.
 3. Number of reflow process shall be 2 times or less.
- Soldering Iron:
Basic spec is ≤ 5 sec when 260 °C. If the temperature is higher, time should be shorter (+10 °C \rightarrow -1 sec). Power dissipation of iron should be smaller than 20W and temperature should be controllable. Surface temperature of the device should be under 230 °C.
 - Rework:
 1. Customer must finish rework within 5 sec under 260 °C
 2. The head of iron cannot touch copper foil
 3. Twin-head type is preferred.

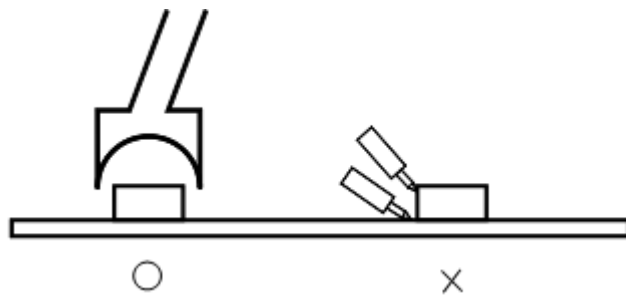

ChromeLED Corp. reserves the right to make changes at any time in order to supply the best product possible. The most current version of this document will always be available at: www.chromeled.com