



SPECIFICATION SHEET

| | |
|--------------------------------|---|
| SPECIFICATION SHEET NO. | Q0608- CRARU03DB20KS1 |
| DATE | June. 8, 2023 |
| REVISION | A0 |
| DESCRIPTION | High Precision Power Thin Film Chip Resistors, 0603 (1608 Metric), ARU03 Series, Dimension L1.55*W0.80*H0.45mm, 2 Terminations, Tolerance: $\pm 0.5\%$, Resistance 20K ohm, Dissipation Max. 1/10W @ 70°C, Temperature Coefficient Rate (TCR) Max. $\pm 25\text{ppm}/^\circ\text{C}$ Operating Temp. Range -55°C ~+155°C Package in Tape/Reel, 5,000pcs/Reel RoHS/RoHS III compliant and HF |
| CUSTOMER | |
| CUSTOMER PART NUMBER | |
| CROSS REF. PART NUMBER | |
| ORIGINAL PART NUMBER | Aillen ARU03DB20K |
| PART CODE | CRARU03DB20KS1 |

| | | | |
|-------------------------|---|--|---|
| VENDOR APPROVE | | | |
| Issued/Checked/Approved |  |  |  |
| DATE: June. 8, 2023 | | | |

| | |
|-------------------------|--|
| CUSTOMER APPROVE | |
| | |
| DATE: | |

6/8/2023

HIGH PRECISION POWER CHIP RESISTORS ARU03 SERIES

DESCRIPTION

The resistors are constructed in a high grade ceramic body (aluminum oxide). Internal metal electrodes are added at each end and connected by a resistive paste that is applied to the top surface of the substrate. The composition of the paste is adjusted to give the approximate resistance required and the value is trimmed to within tolerance by laser cutting of this resistive layer. The resistive layer is covered with a protective coat. Finally, the two external end terminations are added. For ease of soldering the outer layer of these end terminations is a Tin (lead free) alloy.



MAIN FEATURE

- SMD metal film resistor
- High reliability and stability of 0.5% and below per customer request
- High performance of TCR: 25 ppm/°C and below per customer request
- Low current noise
- RoHS compliant and lead free

APPLICATION

- Medical equipment
- Measuring instrument
- Communication device
- Computer / Printer

PART CODE GUIDE

RFQ

[Request For Quotation](#)

| CRARU | 03 | D | B | 20K | S1 |
|-------|----|---|---|-----|----|
| 1 | 2 | 3 | 4 | 5 | 6 |

1) **CRARU**: Product code for High Precision Power Thin Film Chip Resistors

2) **03**: Size Code, 0603 (1608 Metric), ARU03 Series, Dimension L1.55*W0.80*H0.45mm,

3) **D**: Resistance Range Tolerance Code, P: Jumper; B: +/-0.1%; D: +/-0.5%; F: +/-1%; J: +/-5%

4) **B**: Package Code, A: 4Kpcs/7" Reel; B: 5kpcs/7" Reel; C: 10kpcs/7" Reel; M: 15kpcs/7" Reel; D: 10kpcs/10" Reel; E: 20kpcs/10" Reel

5) **20K**: Resistance value code. 0R: 0ohm; R5: 0.5ohm; 15R: 15ohm; 20R: 20ohm; 22R1: 22.1ohm; 51R: 51ohm; 100R: 100ohm;

390R: 390ohm; 1K: 1Kohm; 1K87: 1.87Kohm; 4K7: 4.7Kohm; 10K: 10Kohm; 10K5: 10.5Kohm; 20K: 20 Kohm; 150K: 150Kohm; 226K:

226Kohm; 1M: 1.0Mohm; 1M2: 1.2Mohm

6) **S1**: Internal control code, digits and letter; Blank: N/A

HIGH PRECISION POWER CHIP RESISTORS ARU03 SERIES

DIMENSION (Unit: mm)

Image for reference



General Marking:

3-digits marking

*Each resistor is marked with a three digits code on the protective coating to designate the nominal resistance value

ARU03 series

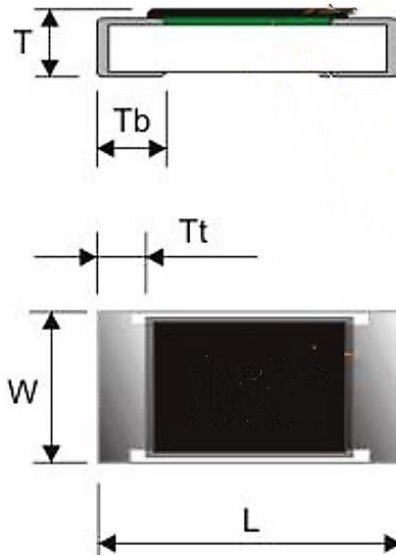

| Item | Dimension |
|------|-----------|
| L | 1.55±0.10 |
| W | 0.80±0.10 |
| T | 0.45±0.15 |
| T b | 0.30±0.15 |
| T t | 0.30±0.15 |

Resistors Construction For Reference

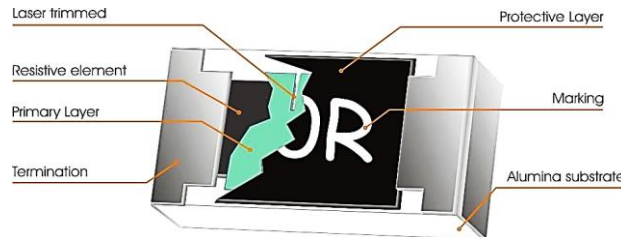

HIGH PRECISION POWER CHIP RESISTORS ARU03 SERIES
GENERAL ELECTRONICAL CHARACTERISTICS

| Item | | Unit | Symbol | Characteristic | Condition |
|------------------------|----------|--------|--------|---|-------------|
| Product Name | | | CRARU | High Precision Power Thin Film Chip Resistors | |
| Size | | | 03 | ARU03 Series, L1.55*W0.80*H0.45mm | |
| Resistance Range | | Ω | | 20K | |
| Resistance Tolerance | | % | D | +/-0.5 | |
| TCR | 4.7Ω~1MΩ | ppm/°C | | ±25 | |
| Max. Dissipation | | W | | 1/10 | @ Tamb=70°C |
| Operating Temperature | | °C | | -55 ~+155 | |
| Max. Operation Voltage | | V | | 75 | @DC or RMS |
| Max. Overload Voltage | | V | | 150 | @DC or RMS |

Note

- 1) This is the maximum voltage that may be continuously supplied to the resistor element, see "IEC publication 60115-8"
- 2) Max. Operation Voltage : So called RCWV (Rated Continuous Working Voltage) is determined by

$$RCWV = \sqrt{\text{Rated Power} \times \text{Resistance Value}} \text{ or Max. RCWV listed above, whichever is lower.}$$

HIGH PRECISION POWER CHIP RESISTORS ARU03 SERIES

PRODUCT CHARACTERIZATION

Standard values of nominal resistance are taken from the E24 & E96 series for resistors with a tolerance of $\pm 0.1\%$, $\pm 0.5\%$, $\pm 1\%$ & $\pm 5\%$. The values of the E24/E96 series are in accordance with "IEC publication 60063"

DERATING

The power that the resistor can dissipate depends on the operating temperature; see Fig.1



Fig 1 Maximum dissipation in percentage of rated power as a function of the ambient temperature for ARU03

MOUNTING

Due to their rectangular shapes and small tolerances, Surface Mountable Resistors are suitable for handling by automatic placement systems. Chip placement can be on ceramic substrates and printed-circuit boards (PCBs). Electrical connection to the circuit is by individual soldering condition. The end terminations guarantee a reliable contact.

HIGH PRECISION POWER CHIP RESISTORS ARU03 SERIES

REFLOW SOLDERING CONDITION

The robust construction of chip resistors allows them to be completely immersed in a solder bath of 260 °C for 10 seconds. Therefore, it is possible to mount Surface Mount Resistors on one side of a PCB and other discrete components on the reverse (mixed PCBs). Surface Mount Resistors are tested for solderability at 235 °C during 2 seconds. The test condition for no leaching is 260°C for 30 seconds. Typical examples of soldering processes that provide reliable joints without any damage are given in Fig 2.

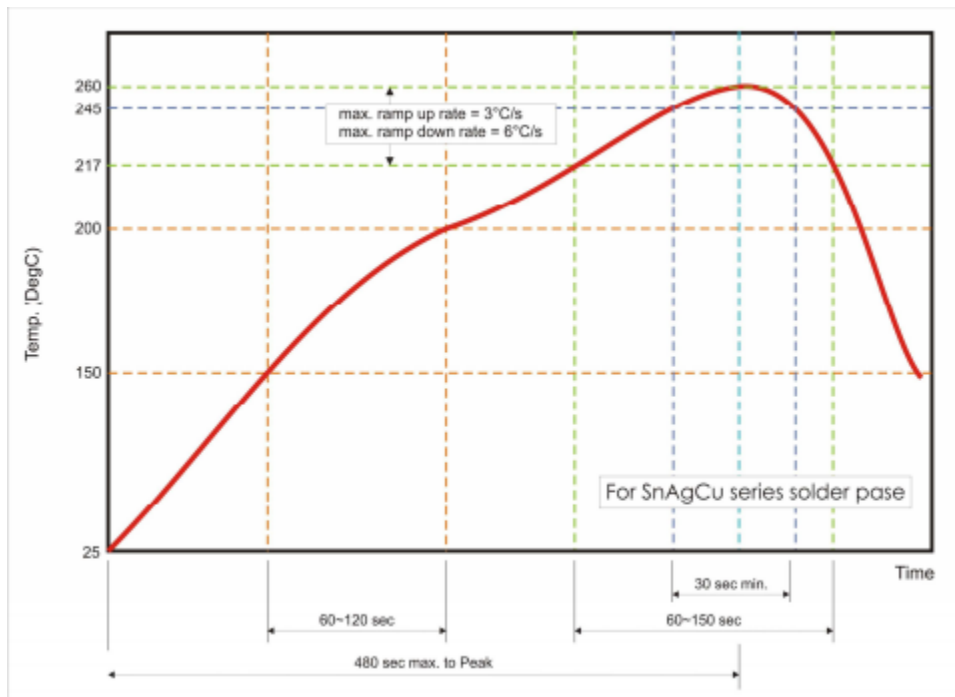

Fig 2. Infrared soldering profile for Chip Resistors

Table 1. Infrared soldering condition for Chip Resistors

| Temperature Condition | Exposure Time |
|---------------------------------------|-----------------------------|
| Average ramp-up rate (217°C to 260°C) | Less than 3°C/second |
| Between 150 and 200°C | Between 60- 120 seconds |
| > 217°C | Between 60- 150 seconds |
| Peak Temperature | 260°C +0/-5°C |
| Time within 245°C | Min. 30 seconds |
| Ramp-down rate (Peak to 217°C) | Less than 6°C/second |
| Time from 25°C to Peak | No greater than 480 seconds |

HIGH PRECISION POWER CHIP RESISTORS ARU03 SERIES
TEST AND REQUIREMENT (JIS C 5201-1 : 1998)

| TEST | PROCEDURE / TEST METHOD | REQUIREMENT |
|--|---|--|
| DC resistance Clause 4.5 | DC resistance values measured | Within the specified tolerance |
| Temperature Coefficient of Resistance(T.C.R) Clause 4.8 | Natural resistance change per change in degree centigrade. $\frac{R_2 - R_1}{R_1(t_2 - t_1)} \times 10^6 \text{ (ppm/}^\circ\text{C)}$ t1 : 20°C+5°C-1°C R1 : Resistance at reference temperature R2: Resistance at test temperature t2 : 125°C+5°C-1°C | Refer to "QUICK REFERENCE DATA" |
| Short time overload (S.T.O.L) Clause 4.13 | Permanent resistance change after a 5second application of a voltage 2.5 times RCWV or the maximum overload voltage specified in the above list, whichever is less. | Δ R/R max. ±(0.2%+0.05Ω) |
| Resistance to soldering heat(R.S.H) IEC 60068-2- 58:2004 | Un-mounted chips completely immersed for 10±1second in a SAC solder bath at 260 ±5°C | Δ R/R max.±(0.25%+0.05Ω) No visible damage |
| Solderability IEC 60068-2- 58:2004 | Un-mounted chips completely immersed for 2±0.5second in a SAC solder bath at 235°C±5°C | Good tinning (>95% covered) No visible damage |
| Temperature cycling Clause 4.19 | 30 minutes at -55°C±3°C, 2~3 minutes at 20°C+5°C-1°C, 30 minutes at +155°C±3°C, 2~3 minutes at 20°C+5°C-1°C, total 5 continuous cycles | Δ R/R max. ±(0.5%+0.05Ω) No visible damage |
| Load Life (Endurance) Clause 4.25 | 70±2°C, 1000 hours, loaded with RCWV or Vmax, 1.5 hours on and 0.5 hours off | Δ R/R max. ±(0.5%+0.05Ω) |
| Humidity Clause 4.24 | 1000 hours, at rated continuous working voltage in humidity chamber controller at 40°C± 2°C and 90~95% relative humidity, 1.5hours on and 0.5 hours off | Δ R/R max. ±(0.5%+0.05Ω) |
| Bending strength Clause 4.33 | Resistors mounted on a 90mm glass epoxy resin PCB(FR4); bending : 3 mm, once for 10 seconds. | Δ R/R max. ±(0.1%+0.05Ω) |
| Adhesion Clause 4.32 | Pressurizing force: 5N, Test time: 10±1sec. | No remarkable damage or removal of the terminations. |

HIGH PRECISION POWER CHIP RESISTORS ARU03 SERIES

REEL DIMENSION (Unit: mm)

7": 5,000Ppcs/Reel

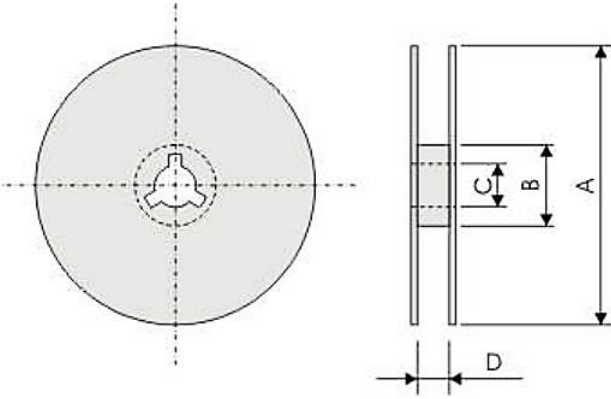

| Code | Dimension 7" |
|------|--------------|
| A | 178+/-2.0 |
| B | 60.0 +/-1.0 |
| C | 13.0+/-0.20 |
| D | 9.0+/-0.5 |

TAPE DIMENSION (Unit: mm)

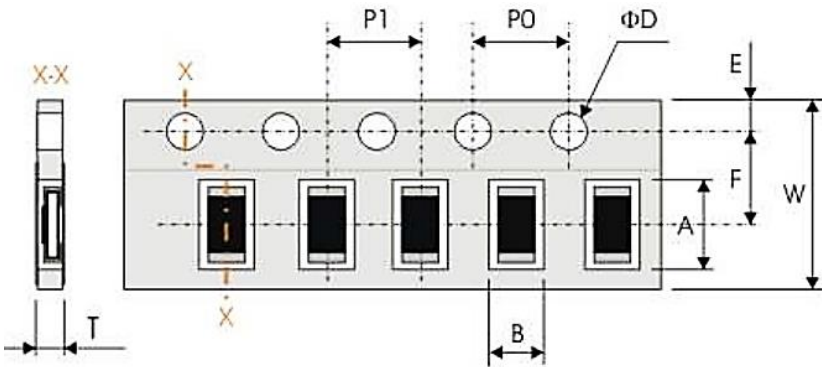

| Code | Dimension |
|------|-----------|
| A | 1.90±0.20 |
| B | 1.10±0.20 |
| W | 8.00±0.30 |
| F | 3.50±0.20 |
| E | 1.75±0.10 |
| P 1 | 4.00±0.10 |
| P0 | 4.00±0.10 |
| ΦD | 1.50±0.10 |
| T | 0.65±0.05 |

TAPING QUANTITY AND TAPE MATERIAL

| Tape | Paper Tape | | | | | | Embossed Tape | Bulk Cassette |
|-----------|------------|-----|-----|------------|-----|-----|---------------|---------------|
| | 4 mm Pitch | | | 2 mm Pitch | | | 4 mm Pitch | |
| Reel Size | 7" | 10" | 13" | 7" | 10" | 13" | 7" | |
| ARU03 | 5000 | | | - | - | - | - | 10000 |

HIGH PRECISION POWER CHIP RESISTORS ARU03 SERIES

PERFORMANCE OF TAPING

Strength of Carrier Tape and Top Cover Tape

Carrier Tape: When a tensile force 1.02kgf is applied in the direction of unreeling the tape, the tape shall withstand this force. Top cover Tape: When a tensile force 1.02kgf is applied to the tape, the tape shall withstand this force.

Peel Force of Top Cover Tape

Unless otherwise specified, the peel force of top cover tape shall be 10.2 to 71.4 g f when the top cover tape is pulled at a speed of 300mm/min with the angle between the taped during peel and the direction of unreeling maintained at 165 to 180° as illustrated in Fig.

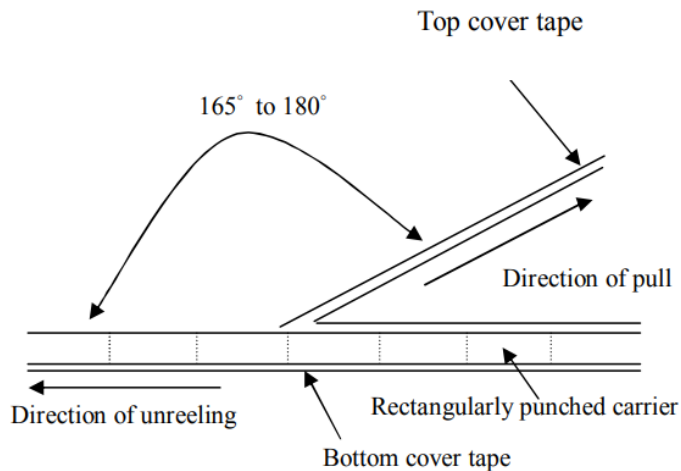

DISCLAIMER

NextGen Component, Inc. reserves the right to make changes to the product(s) and or information contained herein without notice. No liability is assumed as a result of their use or application. No rights under any patent accompany the sale of any such product(s) or information