

# › Universal Digital Timer DIN Rail Mount 17.5 mm

- › Digital timer (LED Screen)
- › Multifunction (23 base functions + options = 138 functions)
- › Precise time configuration
- › Optional features: password setting and time limit setting
- › 2 use modes (basic and advanced)
- › Programmable without power supply
- › Wide time range (from 0.1 seconds up to 100 days)
- › Universal power supply (12-240 V $\sim$ / $\equiv$ )
- › Universal connection



DZ1R08MV1  
Multifunction

Product selection				
Type	Function	Output	Supply Voltage	Part Number
DZ1R	<b>Multifunction Z:</b> (A, Ab, Ac, Ad, Ah, At, B, Bw, C, D, Di, H, Ht, L, Li, O, N, P, Pt, T, TL, Tt, W) + options	1 relay	12 → 240 V $\sim$	<b>DZ1R08MV1</b>

## PART NUMBERING SYSTEM

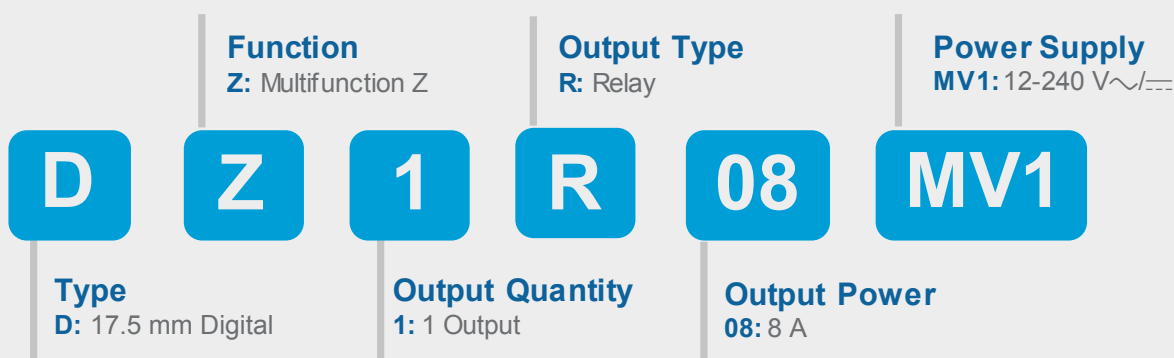

You have a project? Contact us on [www.crouzet.com](http://www.crouzet.com)

### Description:

Syr-line, the specialized range at Crouzet, aimed to satisfy the most unique requirements of your applications by innovating in design, engineering and development.

The Universal Digital Timer, the new Syr-line timer that fits all your needs.

The Universal Digital Timer offers the same ease of use as analog timers but it is powered with visualization, higher-precision and all the functions you need (up to 138).

For more information about Crouzet's Syr-line range, please visit [www.crouzet.com](http://www.crouzet.com).

## DZ1R08MV1

Input Specifications	
Rated supply voltage Un	12 → 240 V $\sim$
Voltage supply tolerance	-15 %, +10 %
AC supply voltage frequency	50 / 60 Hz $\pm$ 5%
Galvanic isolation of supply / inputs	No
Power consumption @ Un	Approx. 2.5 VA (V $\sim$ ) 1 W (V $\text{---}$ )
Immunity to power micro cuts	10 ms
Timing Specifications	
Specified time ranges	0.001 → 9.999 s, 1 s → 99 m 59 s, 1 m → 99 h 59 m, 1 h → 99 d 23 h
Minimum control pulse duration IEC 61812-1	45 ms for PNP mode 150 ms for NPN mode
Recovery time (after by de-energisation) IEC 61812-1	120 ms
Repeatability IEC 61812-1	$\leq$ 0.5 % $\pm$ 150 ms <b>Note:</b> For COMMAND function of SUM and PAUSE, Repeatability is $<$ 0.5 % $\pm$ 250ms
Setting accuracy IEC 61812-1	$\leq$ 0.5 % $\pm$ 150 ms <b>Note:</b> For COMMAND function of SUM and PAUSE, Setting Accuracy is $<$ 0.5 % $\pm$ 250ms
Temperature drift	$\leq$ 0.5 % $\pm$ 50 ms
Voltage drift	$\leq$ 0.5 % $\pm$ 50 ms
Output Specifications	
Contact arrangement	1 CO (SPDT) (ChangeOver - Single Pole Double Throw-)
Maximum switching voltage	250 V $\sim$ / 30 V $\text{---}$
Switching current rate (resistive)	NO / NC: 8 A 250 V $\sim$ / 8 A 30 V $\text{---}$ @ 40 °C NO / NC: 5 A 250 V $\sim$ / 5 A 30 V $\text{---}$ @ 50 °C
Minimum switching contact	10 mA / 5 V $\text{---}$
Maximum switching power (resistive)	2 000 VA / 240 W
Electrical life	10 <sup>5</sup> cycles min at 250 V $\sim$ / 8 A resistive (NO only)
Maximum rate (at max switching power)	360 cycles / hour
Mechanical life	10 x 10 <sup>6</sup> cycles
Rated impulse voltage IEC 60664-1	4 kV (1.2 / 50 $\mu$ s)
Dielectric strength between coil / contacts IEC 60664-1	2.5 kV / 1 min / 1 mA / 50 Hz
Dielectric strength between open contacts	1 kV / 1 min / 1 mA / 50 Hz
Insulation Specifications	
Rated Insulation voltage IEC 60664-1	250 V
Insulation coordination IEC 60664-1	Overvoltage category III; pollution degree 2
Rated impulse voltage IEC 60664-1	4 kV (1.2 / 50 $\mu$ s)
Clearance / Creepage distances (IEC 60664-1)	3 mm / 3.2 mm
Dielectric strength EN-61812-1	2.5 kV / 1 min / 1 mA / 50 Hz
Insulation resistance NFC 93 050	$>$ 500 MOhms / 250 V $\text{---}$ / 1min
General specifications	
Display	1 general control knob 128*32 panel matrix OLED display
Casing DIN 43 880	17.5 mm
Din rail mounting EN 50022	35 mm symmetrical DIN rail
Mounting position	All positions
Housing material UL94	Enclosure plastic type V0
Degree of protection IEC 60529	Housing: IP40 / Terminal block: IP20
Terminal capacity single-wire IEC 60947-1 without ferrule (copper conductors only)	1 x 0.5 → 3.3 mm <sup>2</sup> (AWG 20 → AWG 12) 2 x 0.5 → 1.5 mm <sup>2</sup> (AWG 20 → AWG 16)
Stripping length	6 mm
Maximum tightening torques IEC 60947-1	0.5 N.m / 4.4 lbf.in

**DZ1R08MV1**

Operating temperature IEC 60068-2	-20 → +50 °C
Storage temperature IEC 60068-2	-40 °C → 30 °C Max (for optimal storage time)
Humidity IEC 60068-2-30	93 % without condensation
Vibration resistance IEC 60068-2-6	± 0.15mm from 10 Hz → 60 Hz 2 g from 60 Hz → 150 Hz
Shock resistance IEC 60068-2-27	15 gn - 11 ms; 3 x 6 axis (Output non-energized) 5 gn - 11 ms; 3 x 6 axis (Output energized)
Drop to concrete floor IEC 60068-2-32	High: 0.75 m
Weight	81 g 100 g with packaging

**Standards Specifications**

CEE Directive: 2014/30/EU 2014/35/EU	EMC Low voltage
Approvals / Marking	CE cULus Listed Industrial Control Equipment
Security standard IEC 60664-1	Insulation coordination for equipment within low-voltage systems
Conformity with environmental directives 2015/863/UE 1907/2006 2012/19/UE 2006/66/CE	RoHS Reach WEEE Battery Directive
Product standard IEC 61812-1 UL 60947-4-1	Specified time relays for industrial use Industrial Control Equipment (NRNT- Industrial Control Switches)
Electromagnetic compatibility IEC 61000-6-2 IEC 61000-6-3 IEC 61000-6-4	Immunity for industrial environment Emission residential environment Emission industrial environment
Immunity to electrostatic discharges IEC 61000-4-2	Level III Air ±8 KV / Contact ±6 KV
Immunity to radiated, radio-frequency, electromagnetic field IEC 61000-4-3	Level III 10 V/m (80 MHz → 1 GHz) 80 % AM (1 kHz) 3 V/m (1.4 → 2 GHz) 80 % AM (1 KHz) 1 V/m (2 → 2.7 GHz) 80 % AM (1 KHz)
Immunity to rapid transient bursts IEC 61000-4-4	Level III direct ±2 kV (power supply) capacitive coupling clamp ±1 KV (command input and outputs)
Immunity to shock waves on power supply IEC 61000-4-5	Level III line-to-earth ±2 kV line-to-line ±1 kV
Immunity to radiofrequency in common mode IEC 61000-4-6	Level III 10 Vrms (0.15 → 80 MHz) 80 % AM (1 kHz)
Immunity to voltage dips and breaks IEC 61000-4-11	0 % residual voltage / 1 cycle (Crit. B), 40 % residual voltage / 10 cycles 50 Hz / 12 cycles 60 Hz (Crit C) 70 % residual voltage / 25 cycles 50 Hz / 30 cycles 60 Hz (Crit C) <b>Short interruptions:</b> 0 % residual voltage / 250 cycles 50 Hz / 300 cycles 60 Hz (Crit C)

AC/DC main port emissions IEC 61000-6-3  
IEC 61000-6-4

**DZ1R08MV1**

CISPR 16-2-1 (7.4.1), CISPR 16-1-2 (4.3)  
0.15 MHz – 0.5 MHz, 66 dB(µV) – 56 dB(µV) quasi-peak, 56 dB(µV) – 46 dB(µV) average  
0.5 MHz – 5 MHz, 56 dB(µV) quasi-peak, 46 dB(µV) average  
5 MHz – 30 MHz, 60 dB(µV) quasi-peak, 50 dB(µV) average  
CISPR 14-1  
0.15 MHz – 30 MHz  
CISPR 16-2-1 (7.4.1), CISPR 16-1-2 (4.3)  
0.15 MHz – 0.5 MHz, 79 dB(µV) quasi-peak, 66 dB(µV) average  
0.5 MHz – 30 MHz, 73 dB(µV) quasi-peak, 60 dB(µV) average

Radiated emissions IEC 61000-6-3  
IEC61000-6-4

CISPR 16-2-3  
30 MHz – 230 MHz, 30 dB(µV/m) Quasi-peak at 10 m  
230 MHz – 1 000 MHz, 37 dB(µV/m) Quasi-peak at 10 m  
**Or:**  
30 MHz – 230 MHz, 40 dB(µV/m) Quasi-peak at 3 m in a semi-anechoic chamber  
230 MHz – 1 000 MHz, 47 dB(µV/m) Quasi-peak at 3 m in a semi-anechoic

**Connections**

Universal connection DZ1R08MV1

2 connections options with the same product: type 1 or type 2

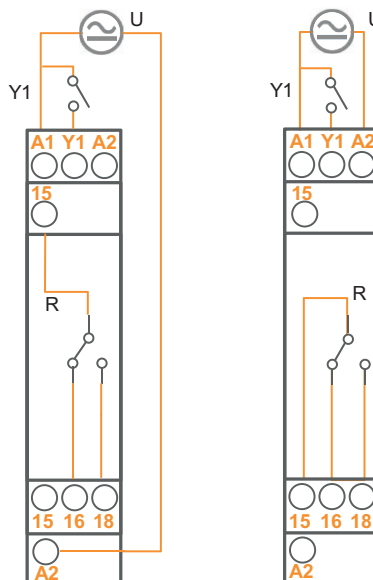
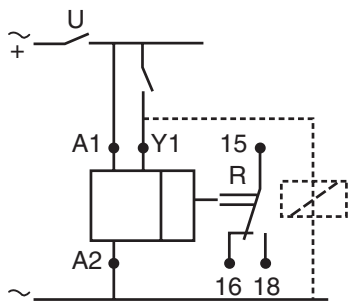

U: Supply

Type 1

Type 2

Y1: Input signal

R: Output relay

**Basic Time Chart**

Function A - On-Delay (Delay on make)

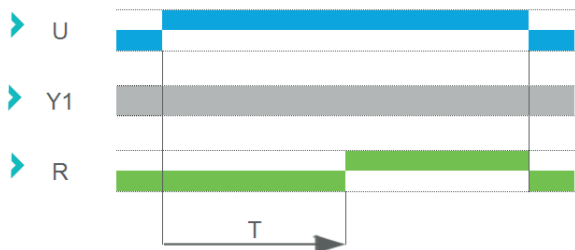

Function Ab - Delayed Interval



Function Ac - On/Off Delay (Delay on make/break)

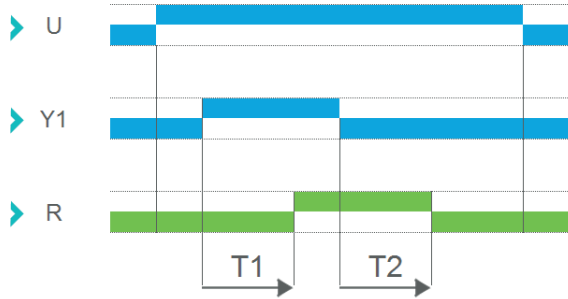

Function Ad - Delay on Start

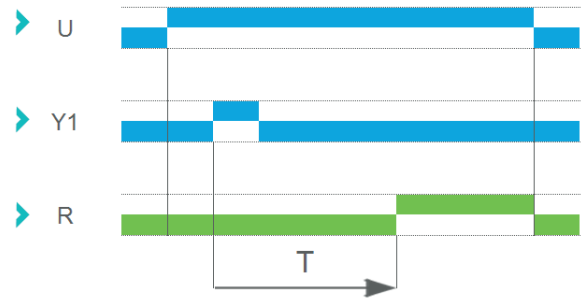

Function Ah - Triggered Flashing Cycle (Single shot flip-flop)

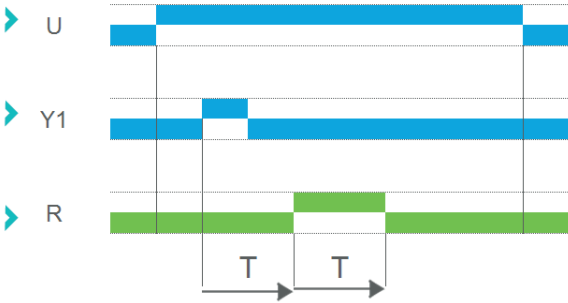

Function At - Summation time relay

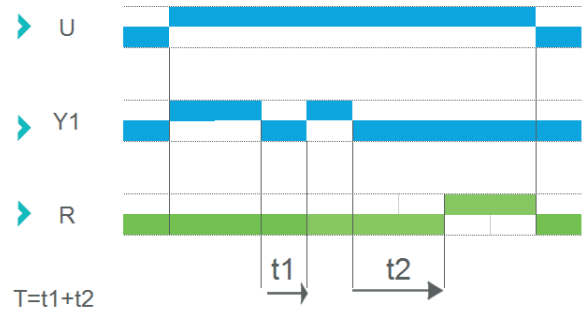

Function B - Single Shot (One Shot)

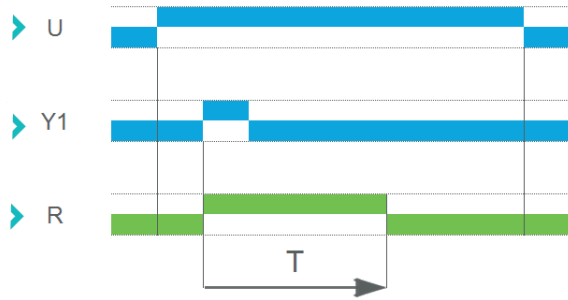

Function Bw - Pulse output

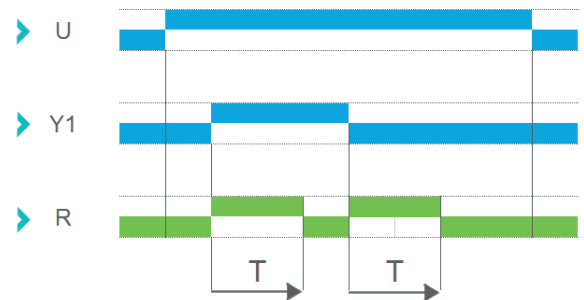

Function C - Off-Delay (Delay on break)

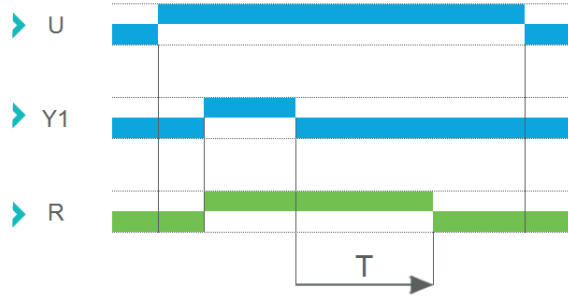

Function D - Flasher (Symmetrical) – OFF Start

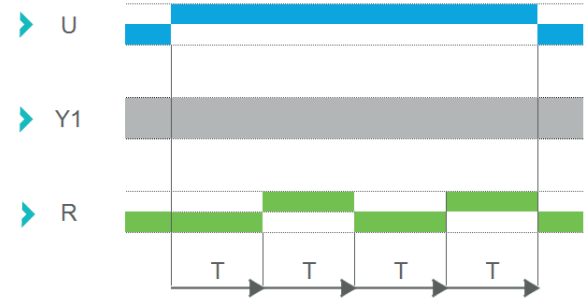

Function Di - Flasher (Symmetrical) – ON Start



Function H - Interval

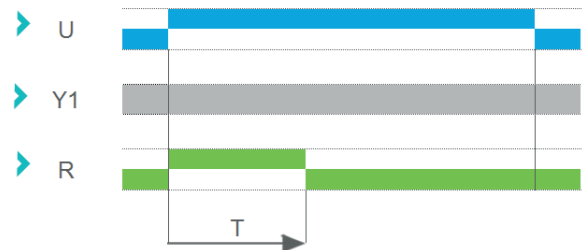

Function Ht - Interval with Memory

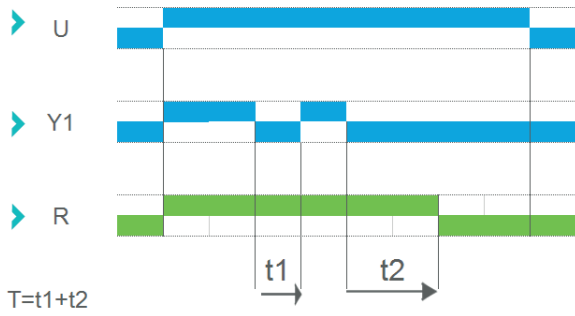

Function L - Repeat Cycle (Asymmetrical) – OFF Start

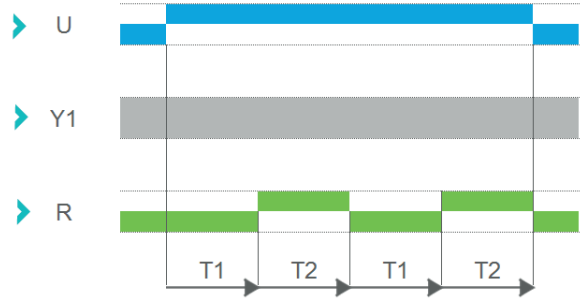

Function Li - Repeat Cycle (Asymmetrical) – ON Start

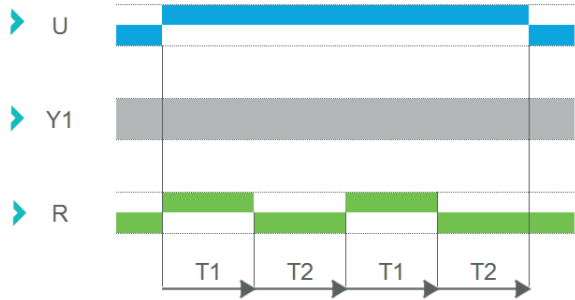

Function O - Delayed watchdog

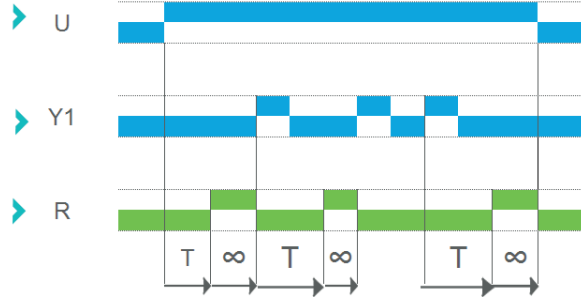

Function N - Watchdog

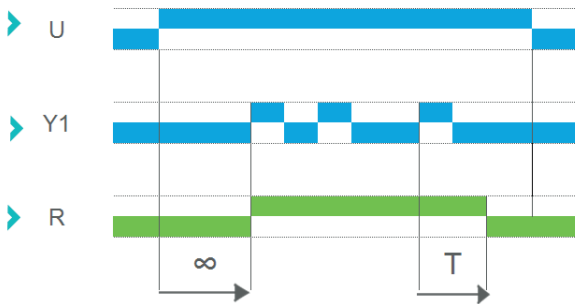

Function P - Pulse delayed relay

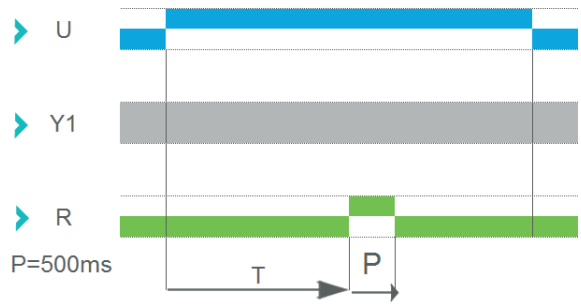

Function Pt - Impulse counter (delay on)

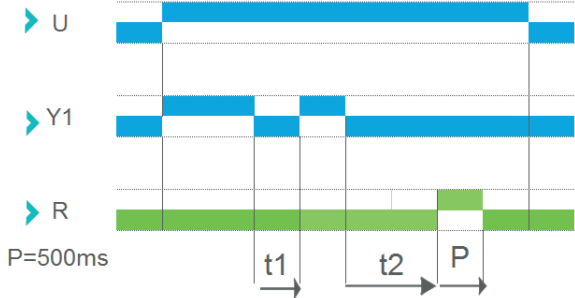

Function T - On-Delay (Delay on make): sum of times

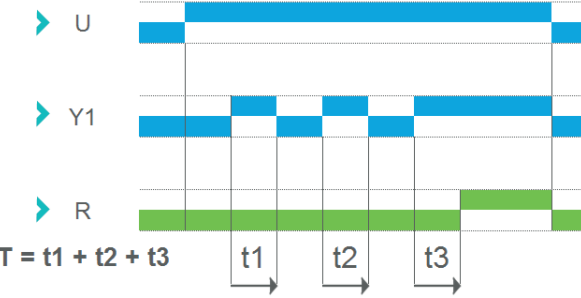

Function TL - Latching (Alternating) – Leading Edge

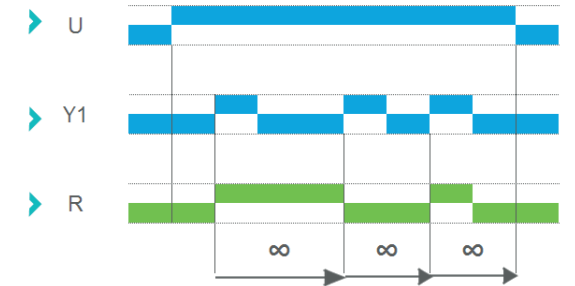

Function Tt - Delayed Latching (Alternating) – Leading Edge

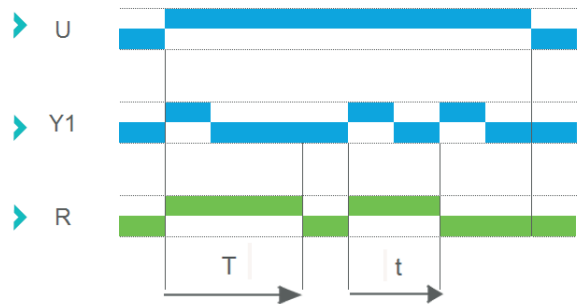

Function W - Timing after pulse of control contact

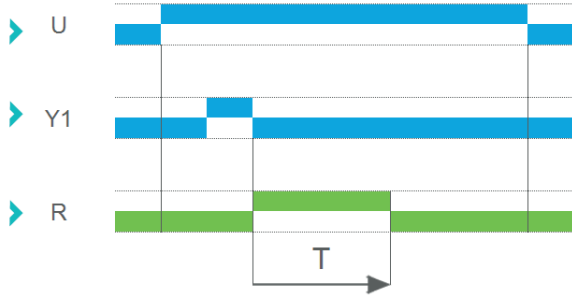

Outline dimensions (mm)

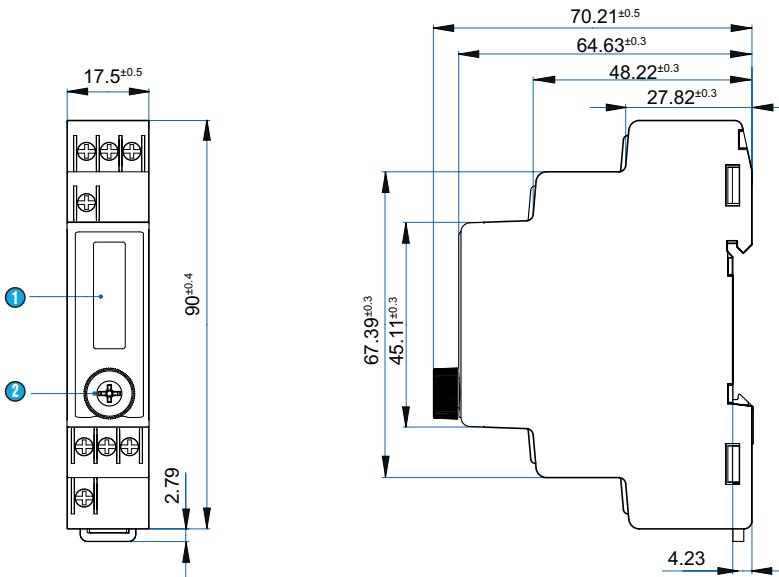

- 1 LED Screen
- 2 Select button

Keys Function

Enter to Timing Change Mode

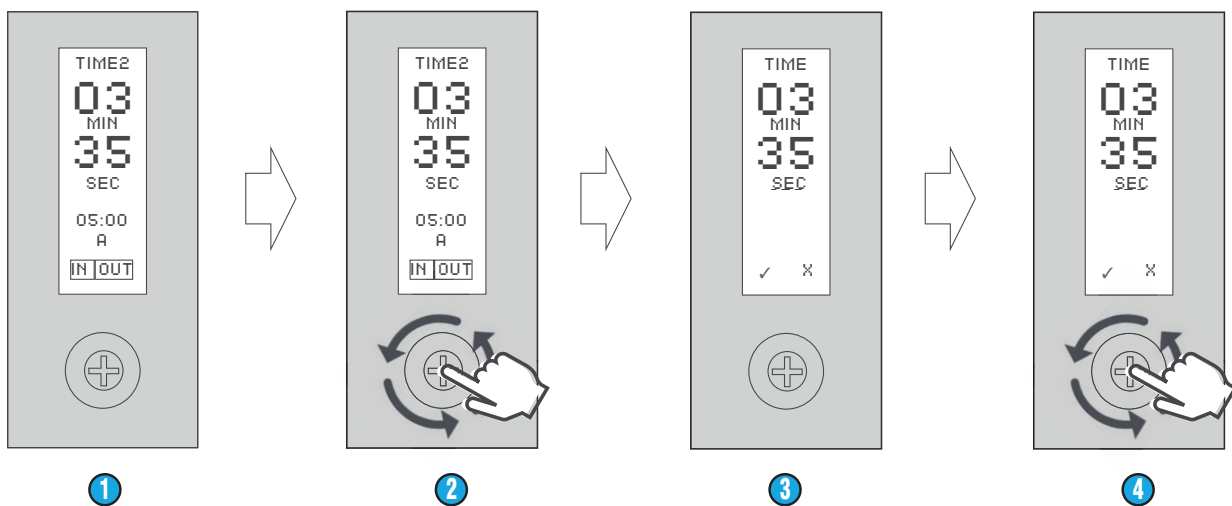

- 1 Run mode
- 2 Press button less than 3 s
- 3 Timing change mode
- 4 Rotate button: change selection / press button: confirm selection

**Keys Function**

**Enter to Programming Mode**

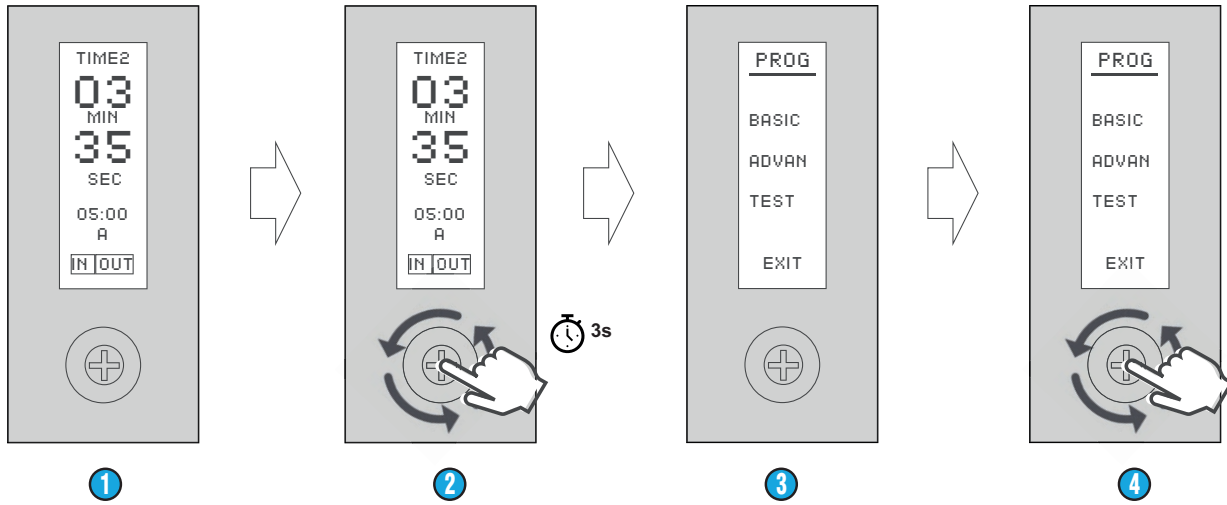

- |   |   |
|---|---|
| 1 | Run mode  |
| 2 | Press button more than 3 s  |
| 3 | Programming mode  |
| 4 | Rotate button: change selection / press button: confirm selection |

**Programming Mode**



**Basic Mode - Timer setting in few seconds**

Programming mode choice

<b>FUNCTION</b> •23 basic functions	<b>RANGE</b> •Milliseconds → Days	<b>COUNT</b> •UP/DOWN	<b>MEMORY</b> •YES/NO
--	--------------------------------------	--------------------------	--------------------------



**Advanced Mode - Optional additional parameters**

<b>INPUT TYPE</b> •PNP •NPN	<b>INPUT FUNCTION</b> •OFF •Trigger •Reset •Sum •Stop	<b>TIME CHANGE</b> •Instantaneous •At end	<b>UPPER LIMIT</b> •Max value
<b>LOWER LIMIT</b> •Min value	<b>BRIGHTNESS</b> •Low •Medium •High	<b>SCREEN SAVER</b> •OFF •_5S → 60S	<b>LOCK</b> •OFF •Programming •ALL
<b>DEFAULT RESET</b> •Reset all			



**Test Mode**

Test mode choice

<b>OUTPUT</b> •ON/OFF	<b>DISPLAY</b> •TEST	<b>MEMORY</b> •TEST
--------------------------	-------------------------	------------------------

**Warning:**

The product information contained in this catalogue is given purely as information and does not constitute a representation, warranty or any form of contractual commitment. Crouzet Automatismes SAS and its subsidiaries reserve the right to modify their products without notice. It is imperative that we should be consulted over any particular use or application of our products and it is the responsibility of the buyer to establish, particularly through all the appropriate tests, that the product is suitable for the use or application. Under no circumstances will our warranty apply, nor shall we be held responsible for any application (such as any modification, addition, deletion, use in conjunction with other electrical or electronic components, circuits or assemblies, or any other unsuitable material or substance) which has not been expressly agreed by us prior to the sale of our products.