

CMKTVS5-4**SURFACE MOUNT SILICON
LOW CAPACITANCE
QUAD TVS/DIODE ARRAY**

www.centrasemi.com

**SOT-363 CASE****DESCRIPTION:**

The CENTRAL SEMICONDUCTOR CMKTVS5-4 is a 4-line TVS/Diode array packaged in a surface mount case. With its low capacitance, this device was designed to protect four high speed data or transmission lines from over-voltage transients and ESD damage.

MARKING CODE: CVT4**APPLICATIONS:**

- USB 2.0 Power and Data Line Protection
- HDMI Interface
- Digital Video Interface (DVI)
- Ethernet Ports

FEATURES:

- Low capacitance
- Low clamping voltage
- Protects four I/O lines
- Protects supply voltage rail

MAXIMUM RATINGS: ($T_A=25^\circ\text{C}$)

Input Voltage	V_I	5.5	V
Electrical Fast Transient (IEC 61000-4-4) (5x50ns)	EFT	40	A
ESD Voltage (IEC 61000-4-2, Air)	V_{ESD}	15	kV
ESD Voltage (IEC 61000-4-2, Contact)	V_{ESD}	8.0	kV
Operating and Storage Junction Temperature	T_J, T_{stg}	-55 to +150	$^\circ\text{C}$

SYMBOL**UNITS****ELECTRICAL CHARACTERISTICS PER DIODE:** ($T_A=25^\circ\text{C}$)

Maximum Reverse Stand-off Voltage V_{RWM}	Minimum Reverse Breakdown Voltage pin 5 to pin 2 $V_Z @ I_Z$		Maximum Reverse Leakage Current pin 5 to pin 2 $I_R @ V_R$		Maximum Clamping Voltage 8x20 μs I/O to pin 2 $V_C @ I_{PP}$		Typical TLP Clamping Voltage (Note 1) $V_{CL} @ I_{PP}$		Typical Dynamic Resistance (Note 1) R_{DYN}	Maximum Off State Junction Capacitance ($V_R=0, f=1.0\text{MHz}$)		
	V	V	mA	μA	V	A	V	A		Ω	I/O to GND	I/O to I/O
											C_J	C_J
5.0	6.0	1.0	3.0	5.0	14	1.0	9.0	1.6	0.72	3.0	1.5	
					23	5.0	14	8.5				

Note 1: Transmission Line Pulse (TLP) conditions: $Z_0=50\Omega, t_p=100\text{ns}$

CMKTVS5-4

SURFACE MOUNT SILICON
LOW CAPACITANCE
QUAD TVS/DIODE ARRAY



SOT-363 CASE - MECHANICAL OUTLINE

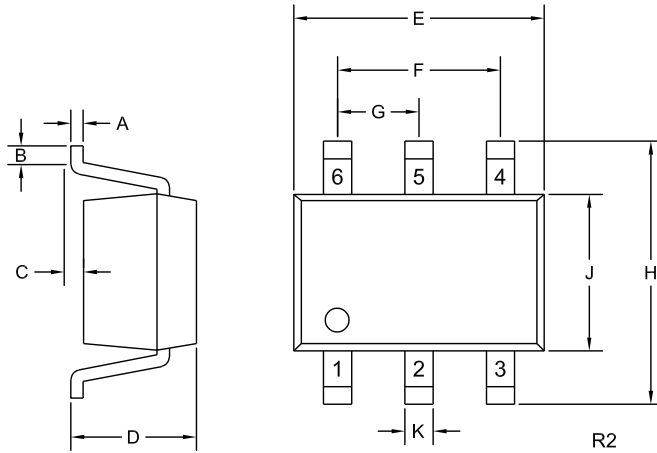

SYMBOL	DIMENSIONS			
			INCHES	MILLIMETERS
	MIN	MAX	MIN	MAX
A	0.004	0.010	0.10	0.25
B	0.005	-	0.12	-
C	0.000	0.004	0.00	0.10
D	0.031	0.043	0.80	1.10
E	0.071	0.087	1.80	2.20
F	0.051		1.30	
G	0.026		0.65	
H	0.075	0.091	1.90	2.30
J	0.043	0.055	1.10	1.40
K	0.006	0.012	0.15	0.30

SOT-363 (REV: R2)

PIN CONFIGURATION

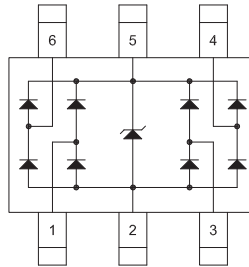

LEAD CODE:

- 1) I/O
- 2) Ground
- 3) I/O
- 4) I/O
- 5) Supply Voltage
- 6) I/O

MARKING CODE: CVT4

SCHEMATIC

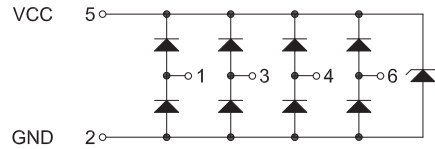

R4 (28-October 2015)

CMKTVS5-4

SURFACE MOUNT SILICON
LOW CAPACITANCE
QUAD TVS/DIODE ARRAY



TYPICAL ELECTRICAL CHARACTERISTICS

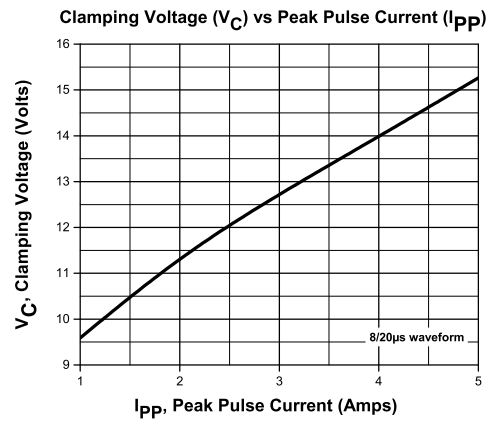
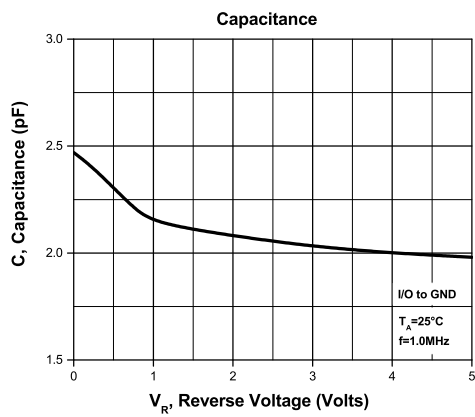
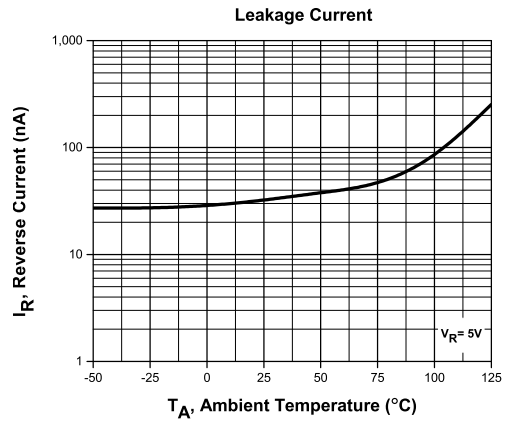
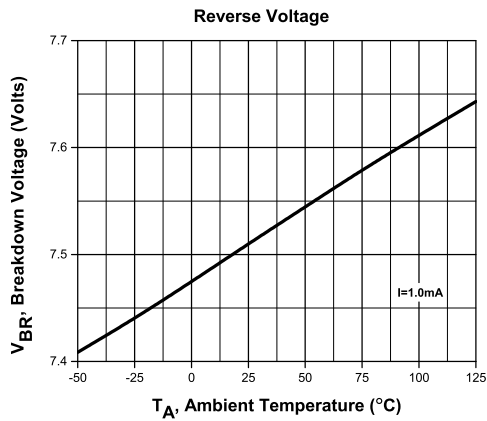

R4 (28-October 2015)

CMKTVS5-4

SURFACE MOUNT SILICON
LOW CAPACITANCE
QUAD TVS/DIODE ARRAY



TYPICAL ELECTRICAL CHARACTERISTICS

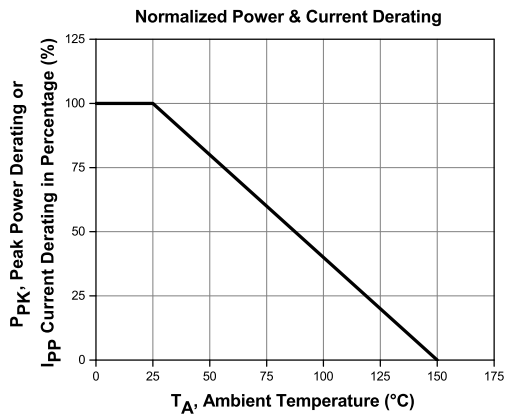
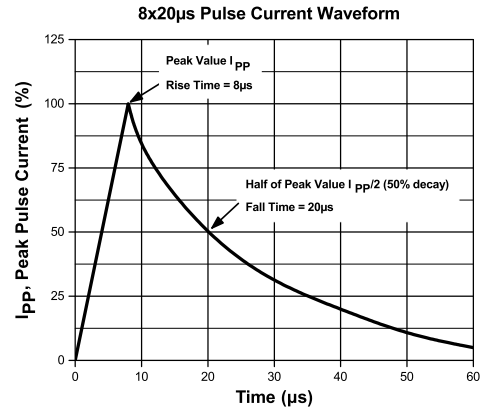
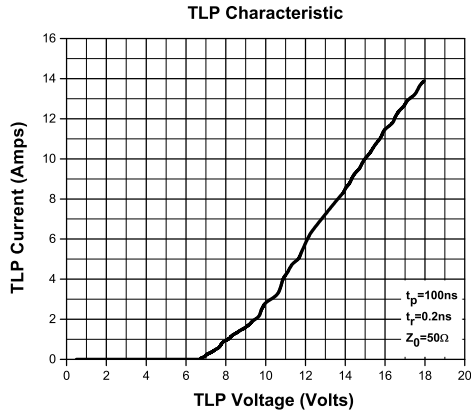

R4 (28-October 2015)

OUTSTANDING SUPPORT AND SUPERIOR SERVICES



PRODUCT SUPPORT

Central's operations team provides the highest level of support to insure product is delivered on-time.

- Supply management (Customer portals)
- Inventory bonding
- Consolidated shipping options
- Custom bar coding for shipments
- Custom product packing

DESIGNER SUPPORT/SERVICES

Central's applications engineering team is ready to discuss your design challenges. Just ask.

- Free quick ship samples (2nd day air)
- Online technical data and parametric search
- SPICE models
- Custom electrical curves
- Environmental regulation compliance
- Customer specific screening
- Up-screening capabilities
- Special wafer diffusions
- PbSn plating options
- Package details
- Application notes
- Application and design sample kits
- Custom product and package development

REQUESTING PRODUCT PLATING

1. If requesting Tin/Lead plated devices, add the suffix "TIN/LEAD" to the part number when ordering (example: 2N2222A TIN/LEAD).
2. If requesting Lead (Pb) Free plated devices, add the suffix "PBFREE" to the part number when ordering (example: 2N2222A PBFREE).

CONTACT US

Corporate Headquarters & Customer Support Team

Central Semiconductor Corp.
145 Adams Avenue
Hauppauge, NY 11788 USA
Main Tel: (631) 435-1110
Main Fax: (631) 435-1824
Support Team Fax: (631) 435-3388
www.centrasemi.com

Worldwide Field Representatives:
www.centrasemi.com/wwreps

Worldwide Distributors:
www.centrasemi.com/wwdistributors

For the latest version of Central Semiconductor's **LIMITATIONS AND DAMAGES DISCLAIMER**, which is part of Central's Standard Terms and Conditions of sale, visit: www.centrasemi.com/terms



http://www.centrasemi.com

Product End of Life Notification

PDN ID:	PDN01230
Notification Date:	5/10/22
Last Buy Date:	11/10/22
Last Shipment Date	5/10/23

Summary: The CMKTVS5-4 TVS is discontinued and now classified as End Life (EOL).

Although Central Semiconductor Corp. makes every effort to continue to produce devices that have been proclaimed EOL (End of Life) by other manufacturers, it is an accepted industry practice to discontinue certain devices when customer demand falls below a minimum level of sustainability. Accordingly, the following product(s) have been transitioned to End of Life status as part of Central's ongoing Product Portfolio Management. Any replacement products are noted below. The effective date for placing last purchase orders will be six (6) months from the date of this notice and twelve (12) months from the notice date for final shipments, and minimum order quantities may apply. The last purchase and shipment dates may be extended if inventory is available.

*** All Plating types (PBFREE,TIN/LEAD) for each item listed are included in this notice.**

Central Part Number	Suggested Replacement
CMKTVS5-4 BK	N/A
CMKTVS5-4 TR	N/A

Central would be happy to assist you by providing additional information or technical data to help locate an alternate source if we have no replacement available. If you would like assistance, please visit <https://my.centrasemi.com/submit-inquiry?type=ER> to submit an online inquiry.

DISCLAIMER: This End of Life (EOL) notification is in accordance with JEDEC standard JESD48 - Product Discontinuance. Central Semiconductor Corp. will make every effort to offer life-time buy (LTB) opportunities and/or offer replacement devices to existing customers for discontinued devices, however, one or both may not be possible for all devices. Please contact your local Central Semiconductor sales representative for LTB opportunities/additional information.