

Steward

Advanced Ferrite Materials, EMI Suppression, and Inductive Products

Home • Ferrite Product Lines • New Products • Technical • General • Contact • Steward Sales

CM5022R800R-00

STEWARD PART NUMBERING SYSTEM					
CM	2722	R	151	R	- 00
PRODUCT SERIES CODE	PART SIZE CODE	RATED CURRENT CODE	IMPEDANCE VALUE CODE	PACKAGING CODE	ADDITIONAL DESCRIPTION

Ambient Operating Temperature Range : -55°C to + 125°C

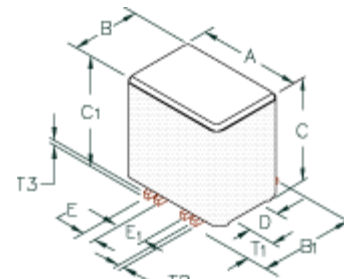

Figure 1

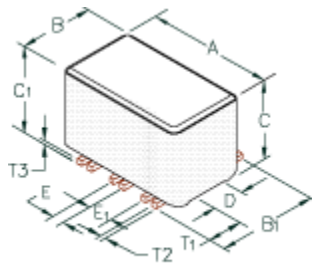

Figure 2

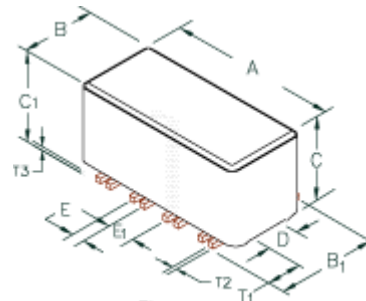

Figure 3

Drawing Figure

Figure Number
3

Electrical Characteristics

NET Z @ 100 MHz	DCR Max	Rated Current mA
80	0.02	5000

Physical Dimensions

A	B	B1	C	C1	D	E	E1	A	B	B1	C	C1	D	E	E1
mm	mm	mm	mm	mm	mm	mm	mm	in	in	in	in	in	in	in	in
12.57	5.72	6.73	4.32	5.00	2.41	0.89	1.91	0.495	0.225	0.265	0.170	0.197	0.095	0.035	0.075

Wire Dimensions

T1 mm	T2 mm	T3 mm	T1 in	T2 in	T3 in
1.91	0.38	0.38	0.075	0.015	0.015

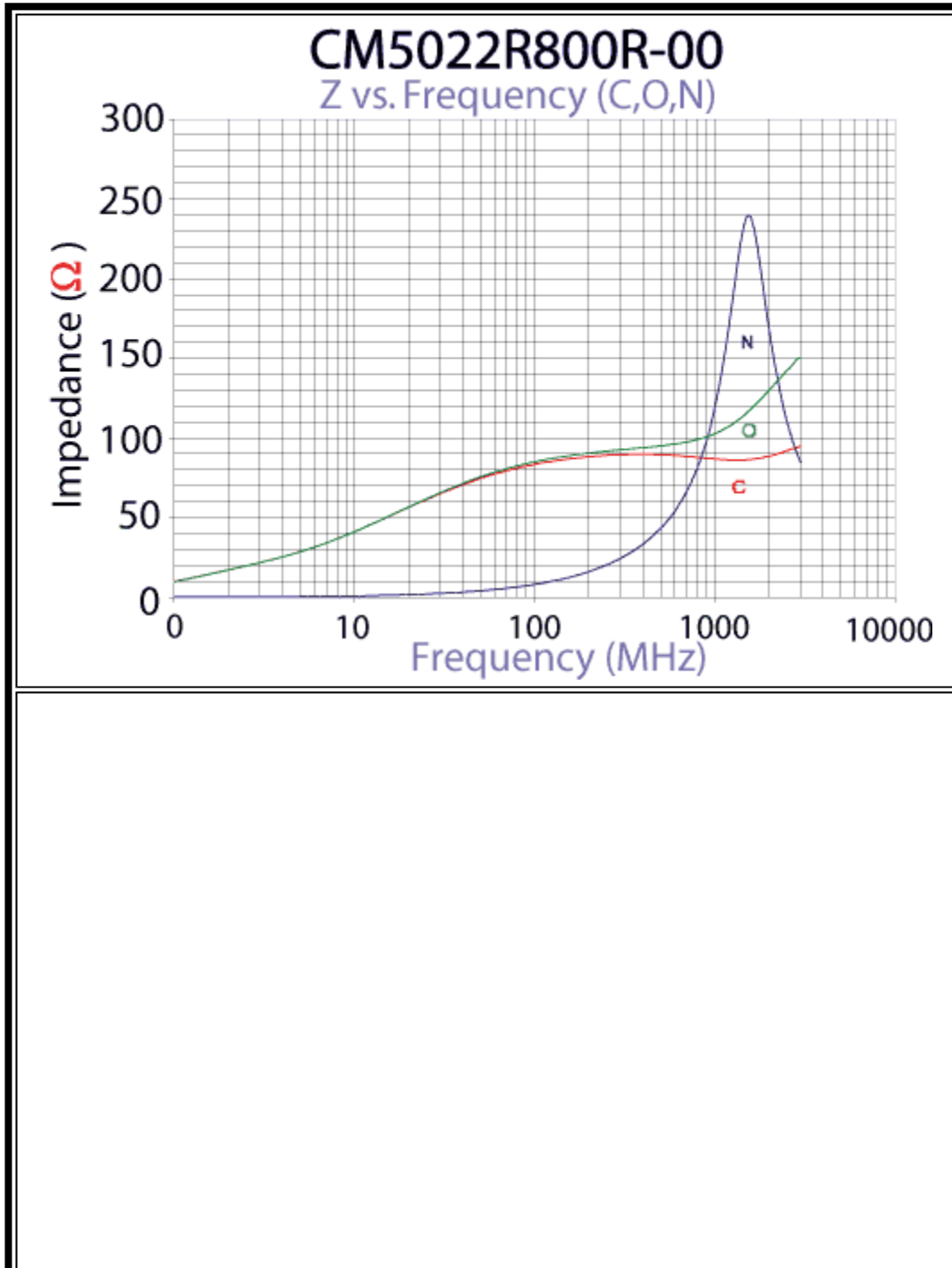

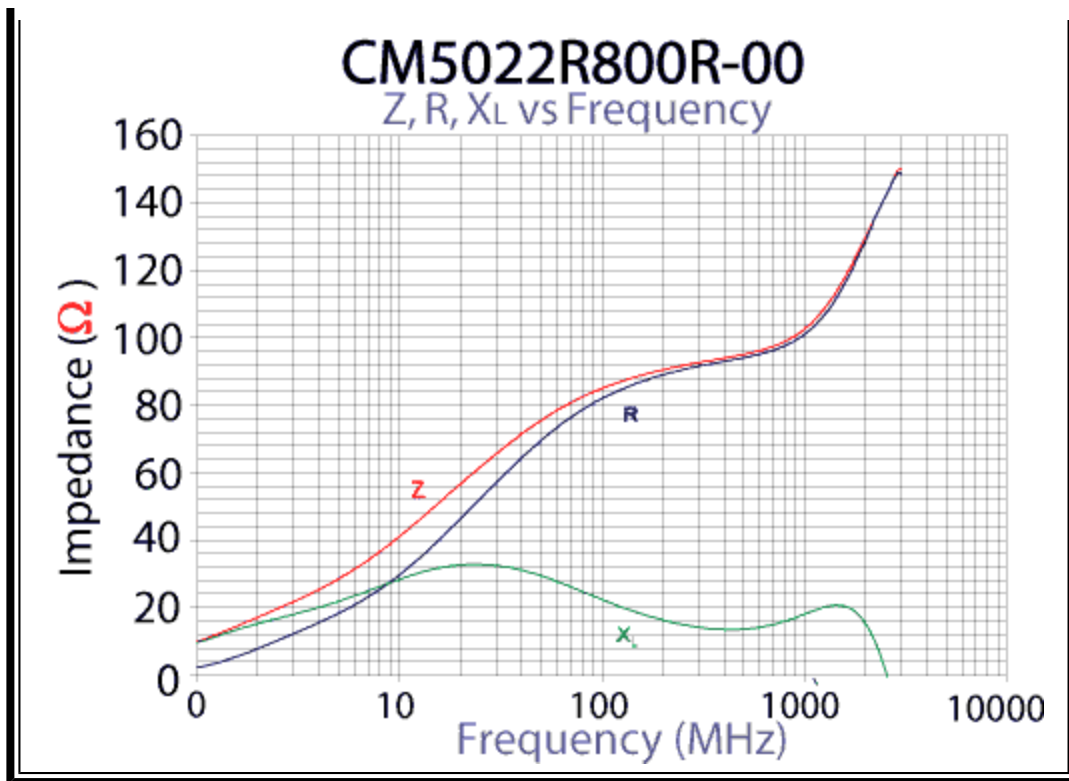

Specifications, which provide more details for the correct use of the described products, are available upon request. All specifications are subject to change without notice. For more information on any of the products listed above, please contact Steward customer service department at (800) 634-2673.

americas@steward.com

mexico@steward.com

europa@steward.com

asia@steward.com

Copyright© 2004 Steward, Inc.

Last Updated: 2/19/2004