

# CGHV40180F

180 W, DC - 2.0 GHz, 50 V, GaN HEMT

## Description

WolfSpeed's CGHV40180F is an unmatched, gallium nitride (GaN) high electron mobility transistor (HEMT). The CGHV40180F, operating from a 50 volt rail, offers a general purpose, broadband solution to a variety of RF and microwave applications. GaN HEMTs offer high efficiency, high gain and wide bandwidth capabilities making the CGHV40180F ideal for linear and compressed amplifier circuits. The transistor is available in a 2-lead flange package.

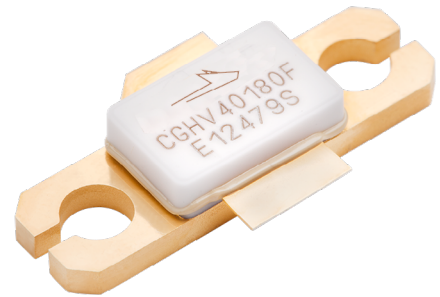

Package Type: 440223  
PN: CGHV40180F

## Typical Performance Over 800 MHz - 1000 MHz ( $T_c = 25^\circ\text{C}$ ), 50 V

Parameter	800 MHz	850 MHz	900 MHz	950 MHz	1000 MHz	Units
Small Signal Gain	25.6	25.2	24.9	24.4	24.3	dB
Gain @ $P_{IN}$ 34 dBm	20.4	20.8	20.3	20.1	20.1	
Output Power @ $P_{IN}$ 34 dBm	275	302	279	257	257	W
EFF @ $P_{IN}$ 34 dBm	67	75	73	73	71	%

Note:  
Measured CW in the CGHV40180F-AMP Application circuit

### Features

- Up to 2.0 GHz Operation
- 24 dB Small Signal Gain at 900 MHz
- 20 dB Power Gain at 900 MHz
- 250 W Typical Output Power at 900 MHz
- 75% Efficiency at  $P_{SAT}$

### Applications

- Military Communications
- Public Safety VHF-UHF applications
- Radar
- Medical
- Broadband Amplifiers

 Large Signal Models Available for ADS and MWO





## Absolute Maximum Ratings (not simultaneous) at 25°C Case Temperature

Parameter	Symbol	Rating	Units	Conditions
Drain-source Voltage	$V_{DSS}$	150	V	25°C
Gate-to-Source Voltage	$V_{GS}$	-10, +2		
Storage Temperature	$T_{STG}$	-65, +150	°C	
Operating Junction Temperature <sup>1</sup>	$T_J$	225		
Maximum Forward Gate Current	$I_{GMAX}$	42	mA	25°C
Maximum Drain Current <sup>1</sup>	$I_{DMAX}$	12.1		
Soldering Temperature <sup>2</sup>	$T_S$	245	°C	
Screw Torque	$\tau$	40	in-oz	
CGHV40180F Thermal Resistance, Junction to Case	$R_{\theta JC}$	0.95	°C/W	$P_{DISS} = 150, 85^\circ\text{C}$
Maximum dissipated power		150	W	
Case Operating Temperature <sup>3</sup>	$T_C$	-40, +150	°C	

Notes:

<sup>1</sup> Current limit for long term, reliable operation

<sup>2</sup> Refer to the Application Note on soldering at [wolfspeed.com/rf/document-library](http://wolfspeed.com/rf/document-library)

<sup>3</sup> See also, Power Derating Curve on Page 5

## Electrical Characteristics

Characteristics	Symbol	Min.	Typ.	Max.	Units	Conditions
<b>DC Characteristics<sup>1</sup> (<math>T_C = 25^\circ\text{C}</math>)</b>						
Gate Threshold Voltage	$V_{GS(th)}$	-3.8	-3.0	-2.3	$V_{DC}$	$V_{DS} = 10\text{ V}, I_D = 41.8\text{ mA}$
Gate Quiescent Voltage	$V_{GS(Q)}$	—	-2.7	—		$V_{DS} = 50\text{ V}, I_D = 1000\text{ mA}$
Saturated Drain Current	$I_{DS}$	27.2	38.9	—	A	$V_{DS} = 6.0\text{ V}, V_{GS} = 2.0\text{ V}$
Drain-Source Breakdown Voltage	$V_{BR}$	125	—	—	$V_{DC}$	$V_{GS} = -8\text{ V}, I_D = 41.8\text{ mA}$
<b>RF Characteristics<sup>2</sup> (<math>T_C = 25^\circ\text{C}</math>, <math>F_0 = 900\text{ MHz}</math> unless otherwise noted)</b>						
Small Signal Gain	$G_{SS}$	23.4	24.0	—	dB	$V_{DD} = 50\text{ V}, I_{DQ} = 1.0\text{ A}, P_{IN} = 10\text{ dBm CW}$
Power Gain	$G_P$	19.3	20.3	—		
Output Power	$P_{OUT}$	53.7	54.3	—	dBm	$V_{DD} = 50\text{ V}, I_{DQ} = 1.0\text{ A}, P_{IN} = 34\text{ dBm CW}$
Drain Efficiency <sup>3</sup>	$\eta$	64	74	—	%	
Output Mismatch Stress	VSWR	—	—	3:1	$\Psi$	No damage at all phase angles, $V_{DD} = 50\text{ V}, I_{DQ} = 1.0\text{ A}, P_{OUT} = 180\text{ W CW}$
<b>Dynamic Characteristics</b>						
Input Capacitance	$C_{GS}$	—	57.8	—	pF	$V_{DS} = 50\text{ V}, V_{GS} = -8\text{ V}, f = 1\text{ MHz}$
Output Capacitance	$C_{DS}$	—	13.7	—		
Feedback Capacitance	$C_{GD}$	—	1.23	—		

Notes:

<sup>1</sup> Measured on wafer prior to packaging

<sup>2</sup> Measurements are to be performed using Wolfspeed production test fixture AD-838292F-TB

<sup>3</sup> Drain Efficiency =  $P_{OUT}/P_{DC}$



**CGHV40180F Typical Performance**

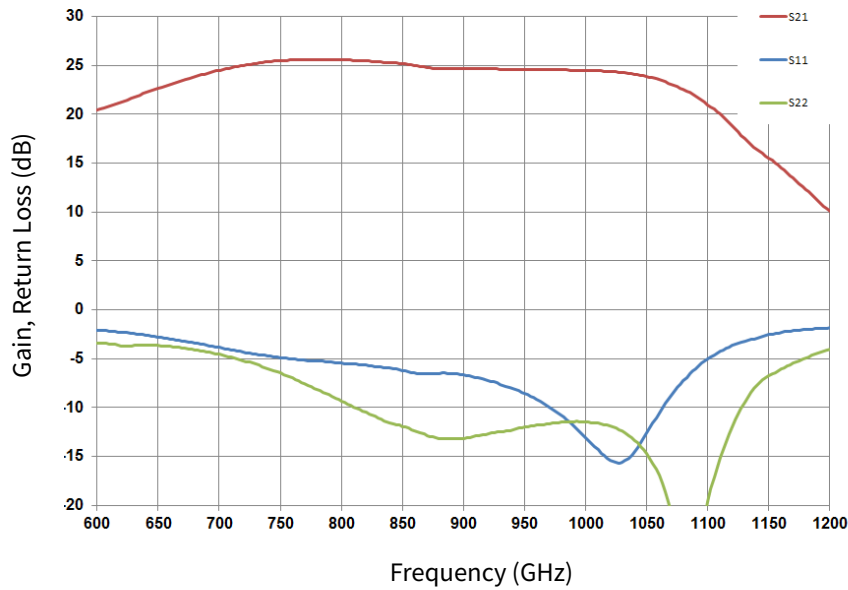

**Figure 1.** Small Signal Gain and Return Loss versus Frequency measured in application circuit CGHV40180F  
 $V_{DD} = 50 \text{ V}$ ,  $I_{DQ} = 1.0 \text{ A}$

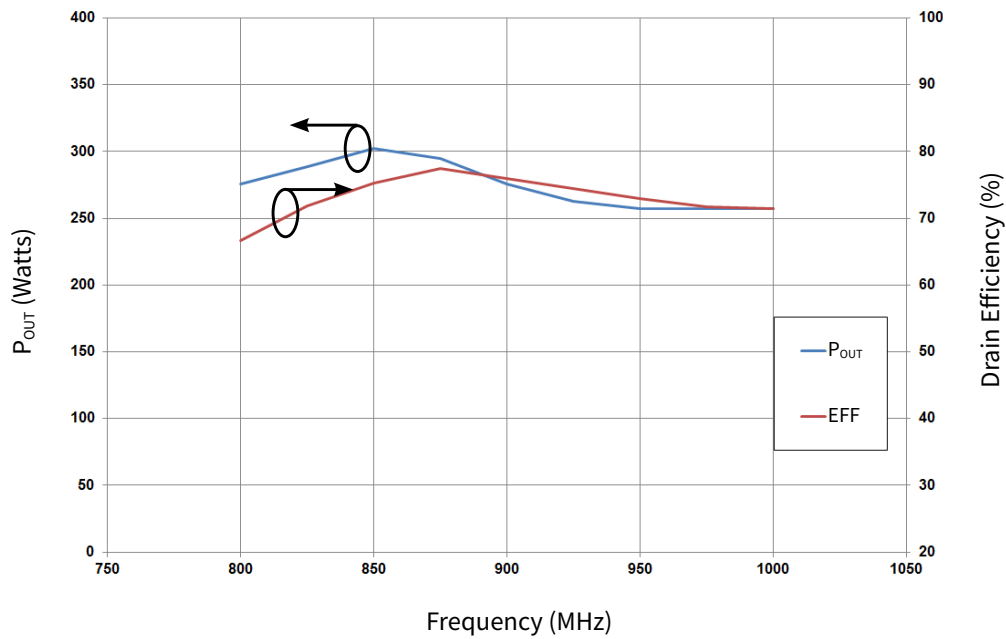

**Figure 2.** Output Power and Drain Efficiency vs Frequency CGHV40180F-TB  
 CW Operation,  $V_{DD} = 50 \text{ V}$ ,  $I_{DQ} = 1.0 \text{ A}$ , @  $P_{IN} 34 \text{ dBm}$



**CGHV40180F Typical Performance**

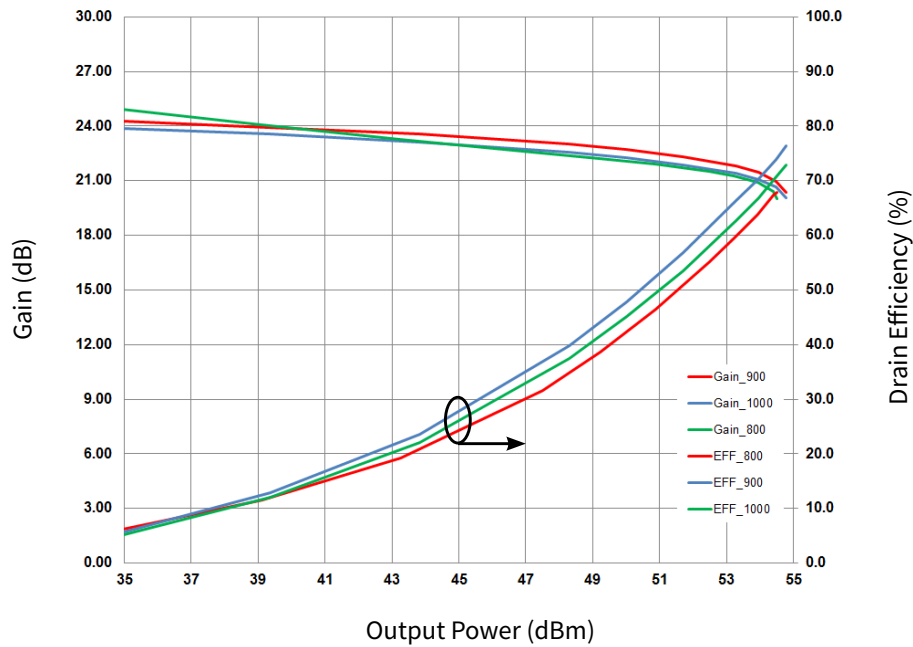

**Figure 3.** Gain and Drain Efficiency vs. Frequency and Output Power  
CGHV40180F-TB CW Operation,  $V_{DD} = 50\text{ V}$ ,  $I_{DQ} = 1.0\text{ A}$

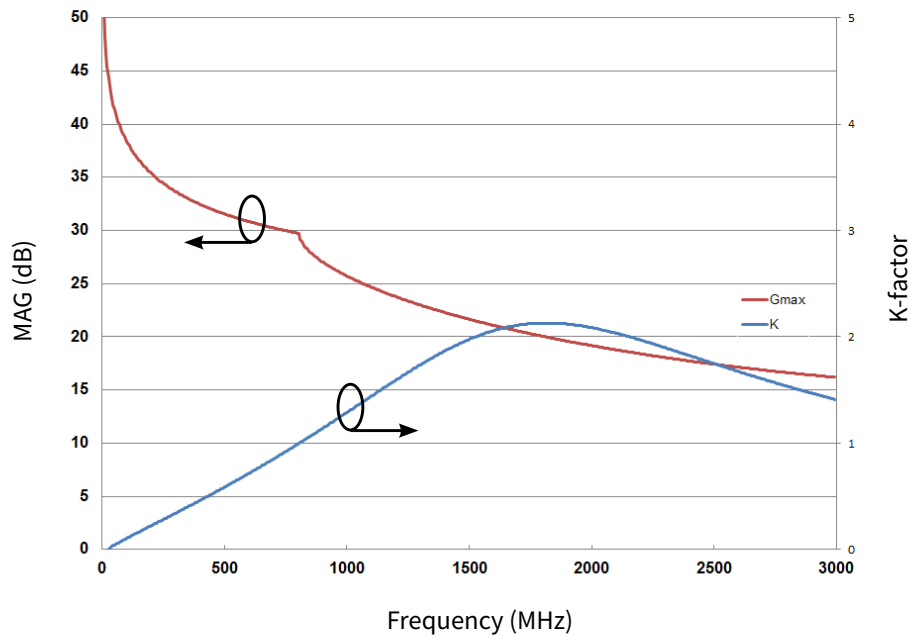

**Figure 4.** Simulated Maximum Available Gain and K-factor of the  
CGHV40180F  $V_{DD} = 50\text{ V}$ ,  $I_{DQ} = 1.0\text{ A}$



### CGHV40180F Power Dissipation De-rating Curve

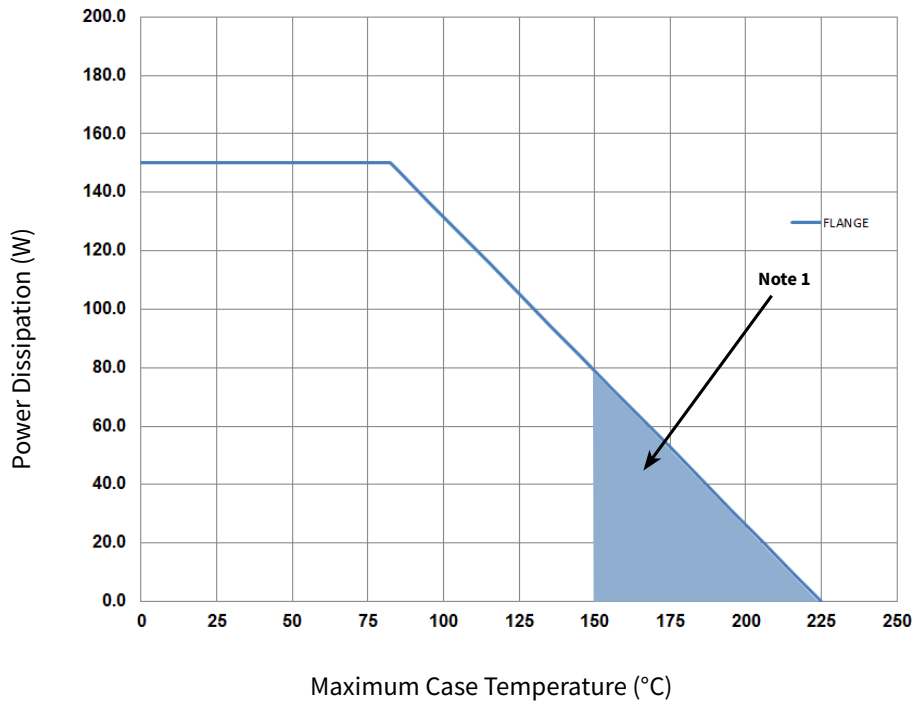
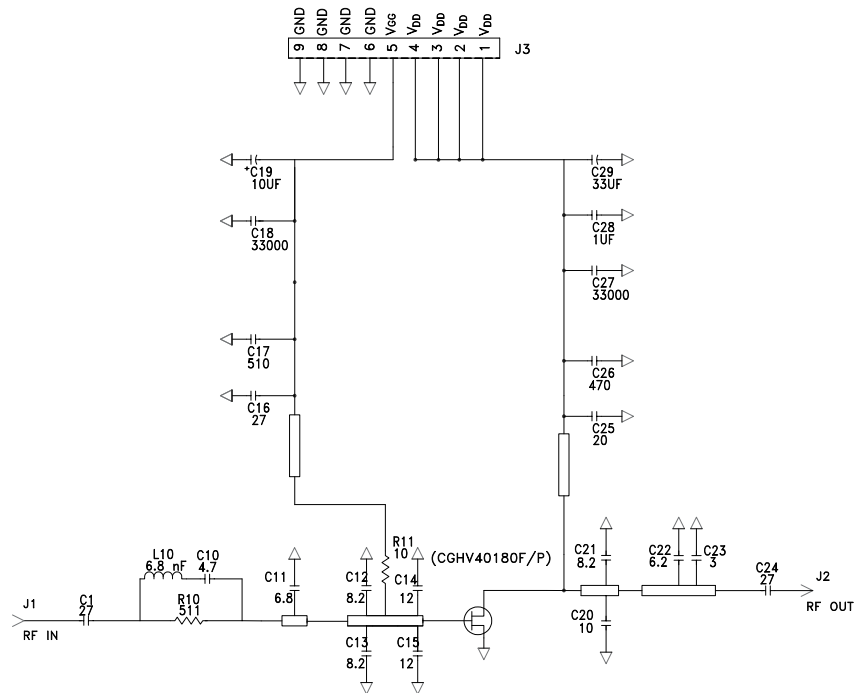

**Figure 5.** Transient Power Dissipation De-rating Curve

Note:  
<sup>1</sup> Area exceeds Maximum Case Operating Temperature (See Page 2)



### CGHV40180F-AMP Application Circuit Schematic



### CGHV40180F-AMP Application Circuit

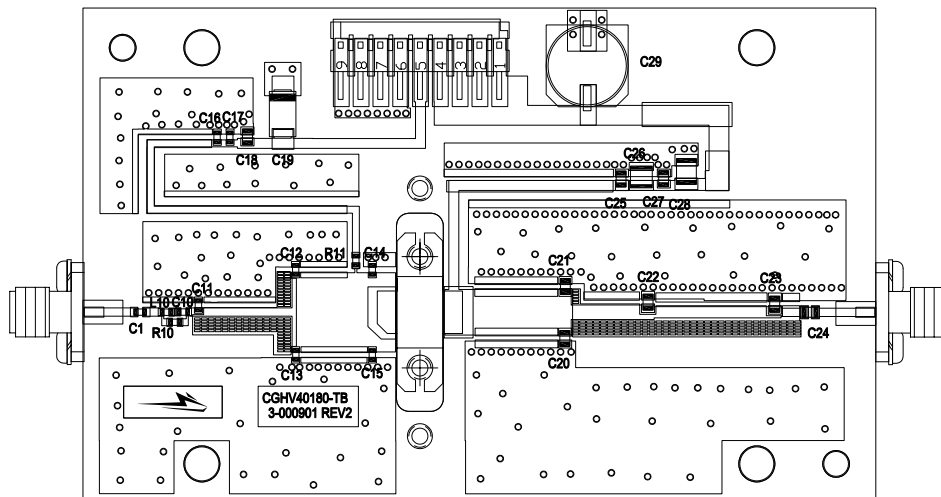



## CGHV40180F-AMP Application Circuit Bill of Materials

Designator	Description	Qty
R11	RES, 1/16W, 0603, 1%, 10.0 OHMS	1
R10	RES, 1/16W, 0603, 1%, 511 OHMS	1
C29	CAP, 33 $\mu$ F, 20%, G CASE	1
C28	CAP, 1.0 $\mu$ F, 100V, $\pm$ 10%, X7R, 1210	1
C17	CAP, 510pF, NPO, 5%, 100V, 0603	1
C26	CAP, 470pF, NPO, 5%, 250V, ATC800B	1
C19	CAP, 10 $\mu$ F, 16V TANTALUM, 2312	1
C14, C15	CAP, 12.0pF, $\pm$ 5%, 0603, ATC600S	2
C1, C16	CAP, 27pF, $\pm$ 5%, 0603, ATC600S	2
C10	CAP, 4.7pF, $\pm$ 0.1pF, 0603, ATC600S	1
C11	CAP, 6.8pF, $\pm$ 0.25pF, 0603, ATC600S	1
C12, C13	CAP, 8.2pF, $\pm$ 0.25pF, 0603, ATC600S	2
C18, C27	CAP, 33000pF, 0805, 100V, X7R	2
C20	CAP, 10pF, $\pm$ 1%, 250V, 0805, ATC600F	2
C25	CAP, 20pF, $\pm$ 5%, 250V, 0805, ATC600F	1
C24	CAP, 27pF, $\pm$ 5%, 250V, 0805, ATC600F	1
C23	CAP, 3.0pF, $\pm$ 0.1pF, 250V, 0805, ATC600F	2
C22	CAP, 6.2pF, $\pm$ 0.1pF, 250V, 0805, ATC600F	1
C21	CAP, 8.2pF, $\pm$ 0.1pF, 250V, 0805 ATC600F	1
-	PCB ROGERS HTC6035, 0.020 THK, ER 3.60	1
J1,J2	CONN, SMA, PANEL MOUNT JACK, FLANGE, 4 HOLE BLUNT POST	2
J3	HEADER RT>PLZ .1CEN LK 9POS	1
L10	INDUCTOR, CHIP, 6.8nH, 5%, 0603 SMT, DIGIKEY 712-1432-1-ND	1
Q1	CGHV40180	1

## CGHV40180F-AMP Demonstration Amplifier Circuit

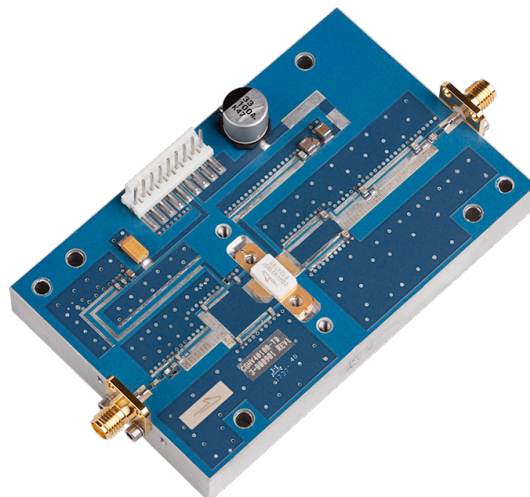



## Electrical Characteristics When Tested in CGHV40180F-AMP3

Characteristics	Symbol	Typ.	Units	Conditions
<b>RF Characteristics<sup>1</sup> (<math>T_c = 25^\circ\text{C}</math>, <math>F_0 = 0.96 - 1.215</math> GHz unless otherwise noted)</b>				
Small Signal Gain	$G_{SS}$	> 20	dB	$V_{DD} = 50$ V, $I_{DQ} = 1.0$ A
Power Gain	$G_P$	> 16	dBm	$V_{DD} = 50$ V, $I_{DQ} = 1.0$ A, $P_{IN} = 38$ dBm, 128 $\mu\text{s}$ , 10% pulse
Output Power	$P_{OUT}$	250	W	
Drain Efficiency	$\eta$	> 75	%	
Output Mismatch Stress	VSWR	3:1	$\Psi$	No damage at all phase angles, $V_{DD} = 50$ V, $I_{DQ} = 1.0$ A, $P_{IN} = 38$ dBm, 128 $\mu\text{s}$ , 10% pulse

Notes:

<sup>1</sup> Measured in CGHV40180F-AMP3 Application Circuit

## Typical Performance in Application Circuit CGHV40180F-AMP3

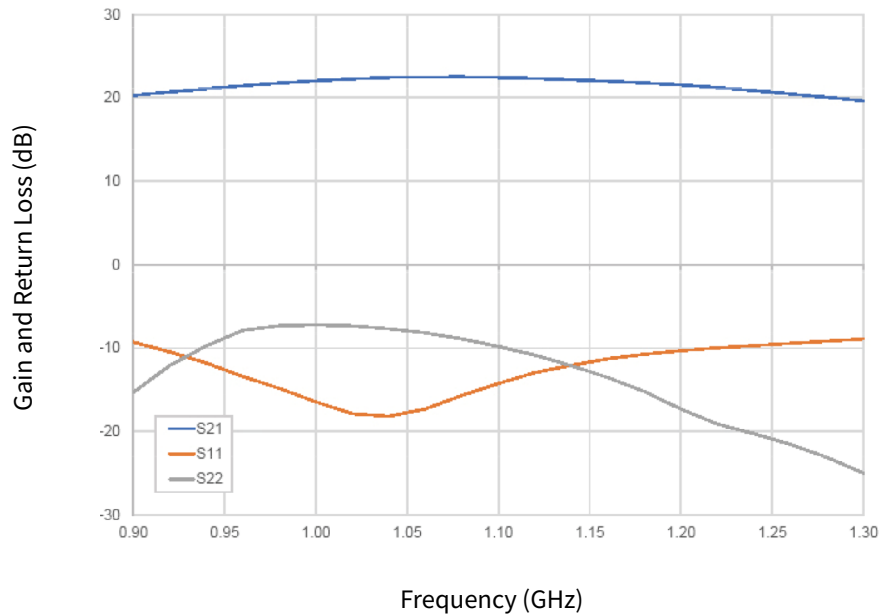
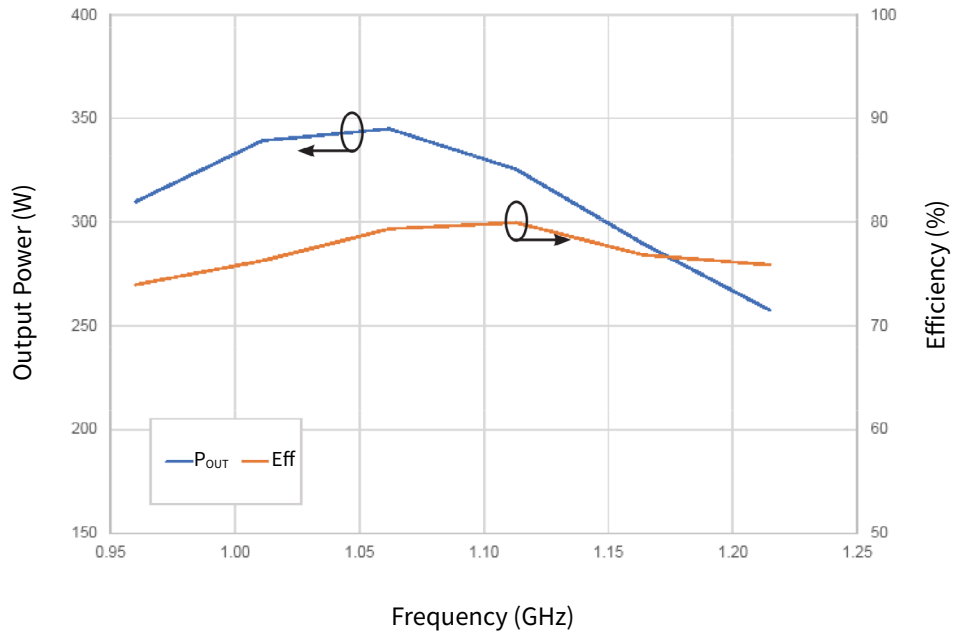

**Figure 6.** Small Signal Gain and Return Losses of the CGHV40180F Measured in Demonstration Amplifier Circuit CGHV40180F-AMP3 CW Operation,  $V_{DD} = 50$  V,  $I_{DQ} = 1.0$  A





**Typical Performance in Application Circuit CGHV40180F-AMP3**



**Figure 7.** Pulsed Output Power and Drain Efficiency vs. Frequency of the CGHV40180F-AMP3  $V_{DD} = 50\text{ V}$ ,  $I_{DQ} = 1.0\text{ A}$ ,  $P_{IN} = 38\text{ dBm}$ ,  $128\text{ }\mu\text{s}$ , 10% pulse

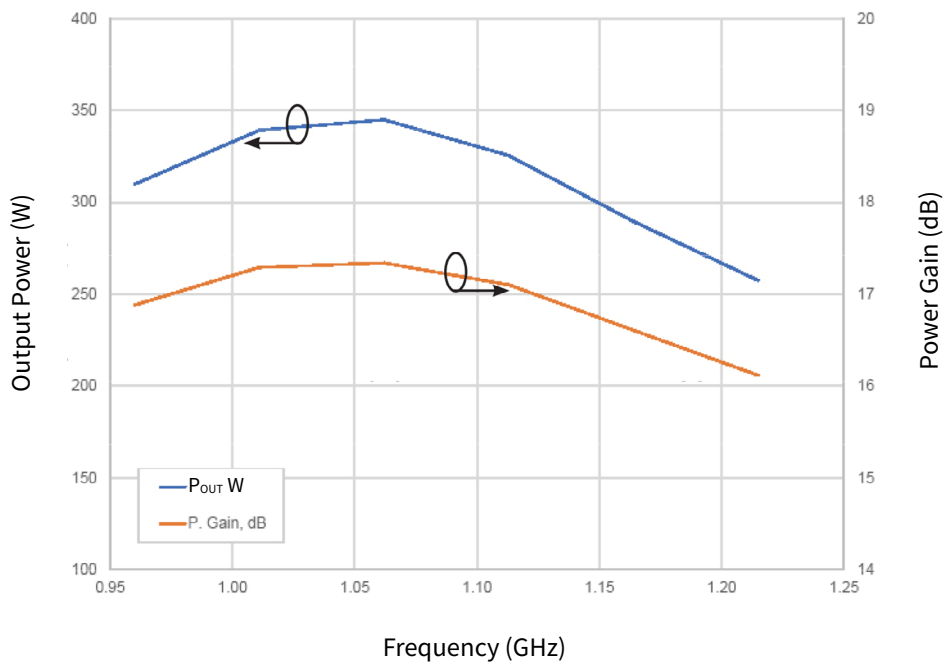

**Figure 8.** Output Power and Power Gain vs. Frequency of the CGHV40180F-AMP3  $V_{DD} = 50\text{ V}$ ,  $I_{DQ} = 1.0\text{ A}$ ,  $P_{IN} = 38\text{ dBm}$ ,  $128\text{ }\mu\text{s}$ , 10% pulse



### CGHV40180F-AMP3 Application Circuit Schematic

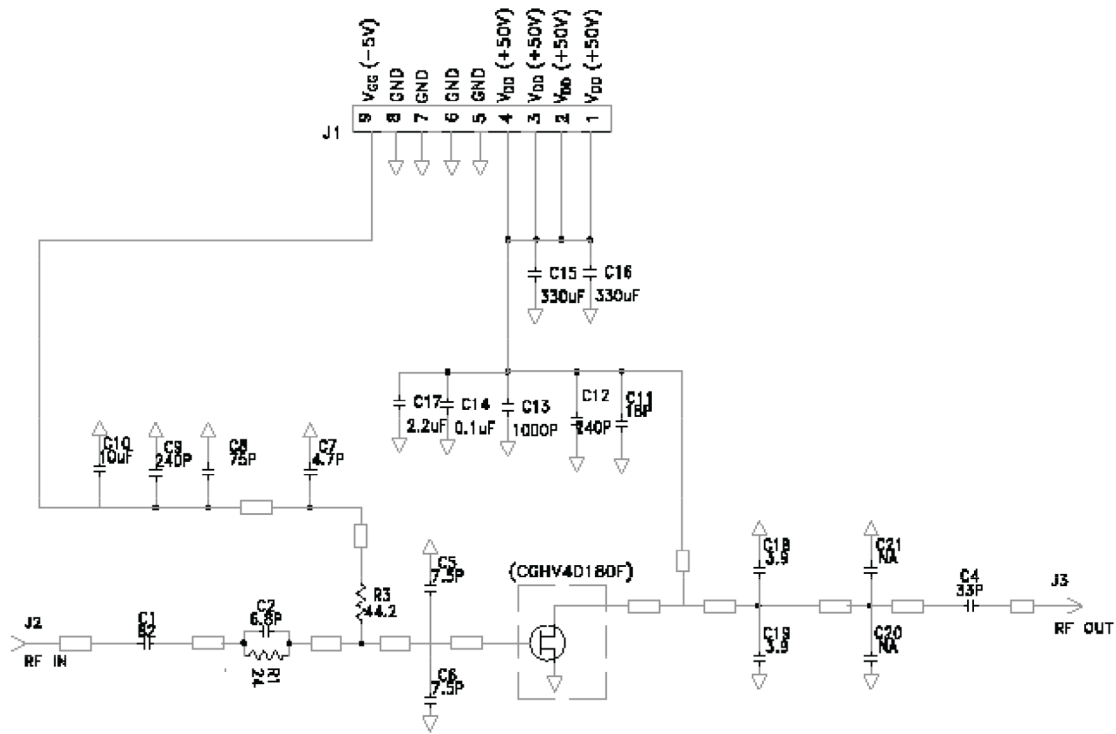

### CGHV40180F-AMP3 Application Circuit

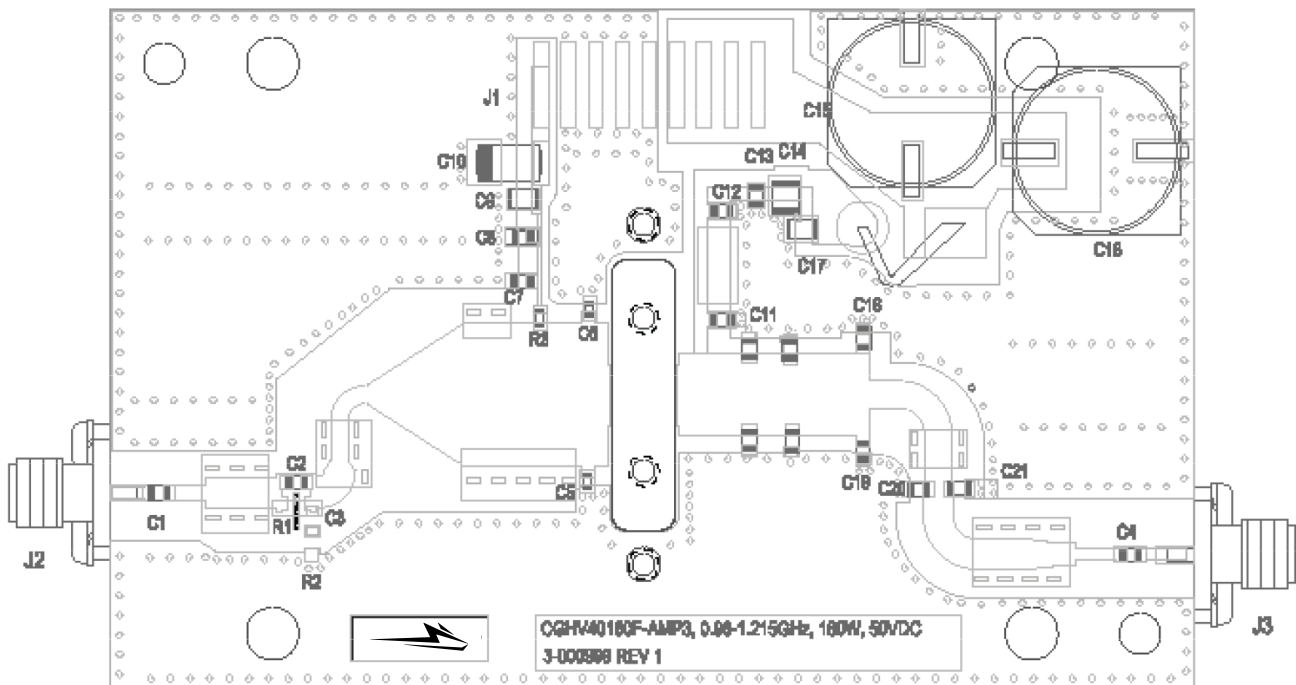



## CGHV40180F-AMP3 Bill of Materials

Designator	Description	Qty
C2	CAP, 8.2pF, +/-0.1pF, 250V, 0805, ATC600F	1
C1	CAP, 82pF, 1%, 250V, 0805, ATC600F	1
C5, C6	CAP, 7.5pF, 1%, 0603, ATC600S	2
C9, C12	CAP, 240pF, 5%, 250V, 0805, ATC600F	1
C7	CAP, 4.7pF, +/-0.1pF, 250V, 0603, ATC600S	1
C8	CAP, 75pF, 5%, 250V, 0805, ATC600F	1
C11	CAP, 18pF, 1%, 250V, 0805, ATC600F	1
C13	CAP, 1000pF, 5%, 250V, 0603	1
C14	CAP, 0.1μF, 5%, 250V, 0805	1
C17	CAP, 2.2μF, 5%, 100V, 1210	1
C15, 16	CAP, 330μF, 20%, 100V, ELEC, Vishay, MAL215099911E3	2
C18, C19	CAP, 3.9pF, +/-0.1pF, 250V, 0805, ATC600F	2
C4	CAP, 33pF, 5%, 250V, 0805, ATC600F	1
C10	CAP, 10μF, 16V, TANTLUM	2
R1	RES, 24 OHM IMS, 1005	1
R3	RES, 1/16W, 0603, 1%, 44.2 OHMS	1
W1	WIRE, 18G, BALCK, 2.5"	1
J2, J3	CONN, SMA, PANEL MOUNT JACK, FL	2
J1	HEADER ST, .1CEN LK 9POS, PBC05SABN	1
-	BASEPLATE	1
-	PCB, RO4350B, 2.5"x4"x0.020"	1
-	#2, WASHER, SPLIT LK, SS	4
-	2-56 SOC HD SCREW 3/16 SS	4
Q1	CGHV40180F	1



## CGHV40180F-AMP3 Demonstration Amplifier Circuit

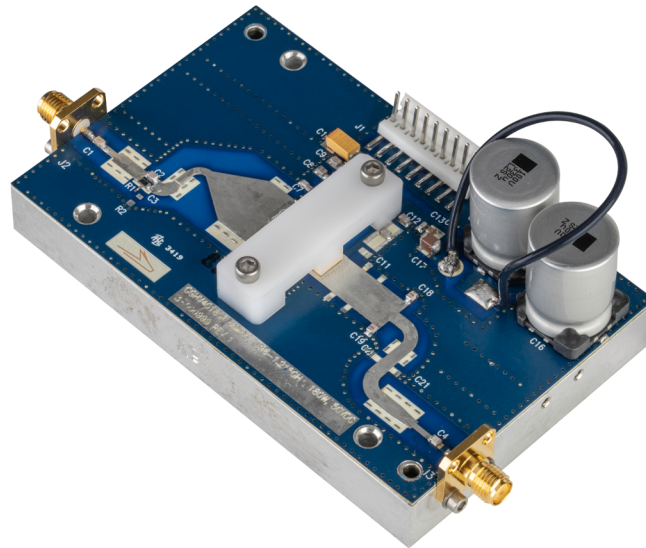

### Source and Load Impedances

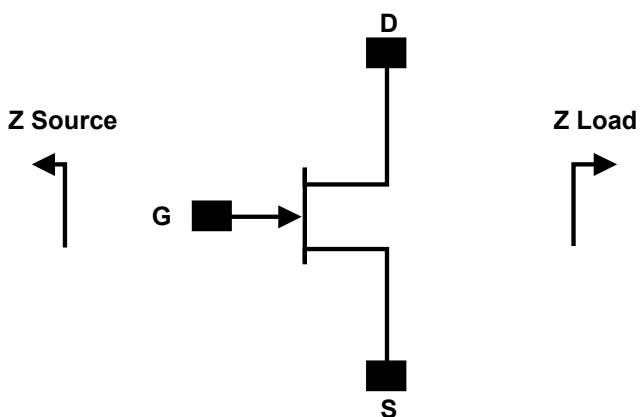

Frequency	Z Source	Z Load
50	23.7 + J25.9	7.6 + J0.6
150	7.4 + J8.3	8.1 + J0.7
250	4.2 + J7.9	7.9 + J2.2
500	1.4 + J1.5	4.7 + J2.7
750	1.0 + J0.0	3.9 + J2.3
1000	0.7 + J1.1	4.0 + J1.8

#### Notes:

<sup>1</sup>  $V_{DD} = 50\text{ V}$ ,  $I_{DQ} = 1.0\text{ A}$  in the 440223 package

<sup>2</sup> Optimized for Power Gain,  $P_{SAT}$  and Drain Efficiency

<sup>3</sup> When using this device at low frequency, series resistor should be used to maintain amplifier stability

### Electrostatic Discharge (ESD) Classifications

Parameter	Symbol	Class	Classification Level	Test Methodology
Human Body Model	HBM	1C	ANSI/ESDA/JEDEC JS-001 Table 3	JEDEC JESD22 A114-D
Charge Device Model	CDM	C3	ANSI/ESDA/JEDEC JS-002 Table 3	JEDEC JESD22 C101-C



**Product Dimensions CGHV40180F (Package Type — 440223)**

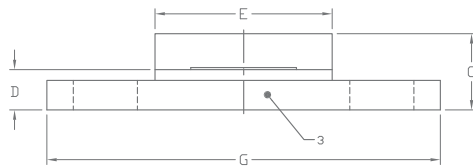
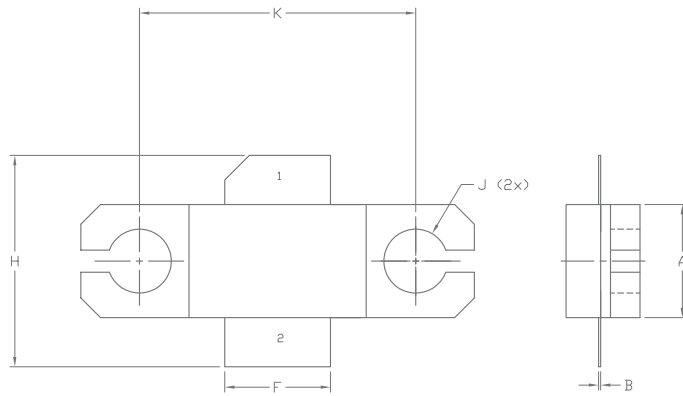

NOTES:

1. DIMENSIONING AND TOLERANCING PER ANSI Y14.5M, 1982.
2. CONTROLLING DIMENSION INCH.
3. ADHESIVE FROM LID MAY EXTEND A MAXIMUM OF 0.020" BEYOND EDGE OF LID.
4. LID MAY BE MISALIGNED TO THE BODY OF THE PACKAGE BY A MAXIMUM OF 0.008" IN ANY DIRECTION.
5. ALL PLATED SURFACES ARE Ni/AU

DIM	INCHES		MILLIMETERS	
	MIN	MAX	MIN	MAX
A	0.225	0.235	5.72	5.97
B	0.004	0.006	0.10	0.15
C	0.145	0.165	3.68	4.19
D	0.077	0.087	1.96	2.21
E	0.355	0.365	9.02	9.27
F	0.210	0.220	5.33	5.59
G	0.795	0.805	20.19	20.45
H	0.400	0.460	10.16	11.68
J	Ø .130		3.30	
k	0.562		14.27	

PIN 1. GATE  
 PIN 2. DRAIN  
 PIN 3. SOURCE



## Part Number System

### CGHV40180F

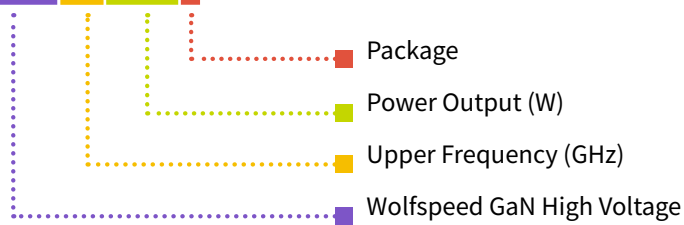

**Table 1.**

Parameter	Value	Units
Upper Frequency <sup>1</sup>	4.0	GHz
Power Output	100	W
Package	Flange	—

Note:

<sup>1</sup> Alpha characters used in frequency code indicate a value greater than 9.9 GHz. See Table 2 for value.

**Table 2.**

Character Code	Code Value
A	0
B	1
C	2
D	3
E	4
F	5
G	6
H	7
J	8
K	9
Examples	1A = 10.0 GHz 2H = 27.0 GHz

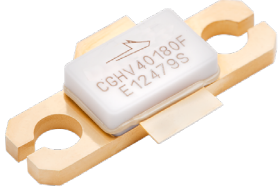
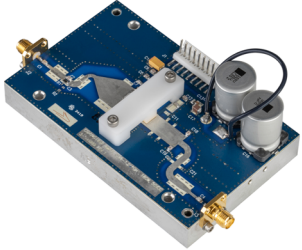

**Product Ordering Information**

Order Number	Description	Unit of Measure	Image
CGHV40180F	GaN HEMT	Each	
CGHV40180F-AMP3	Test board with GaN HEMT (flanged) installed	Each	

**For more information, please contact:**

4600 Silicon Drive  
Durham, NC 27703 USA  
Tel: +1.919.313.5300  
[www.wolfspeed.com/RF](http://www.wolfspeed.com/RF)

Sales Contact  
[RFSales@wolfspeed.com](mailto:RFSales@wolfspeed.com)

RF Product Marketing Contact  
[RFMarketing@wolfspeed.com](mailto:RFMarketing@wolfspeed.com)

## Notes & Disclaimer

---

Specifications are subject to change without notice. “Typical” parameters are the average values expected by Wolfspeed in large quantities and are provided for information purposes only. Wolfspeed products are not warranted or authorized for use as critical components in medical, life-saving, or life-sustaining applications, or other applications where a failure would reasonably be expected to cause severe personal injury or death. No responsibility is assumed by Wolfspeed for any infringement of patents or other rights of third parties which may result from use of the information contained herein. No license is granted by implication or otherwise under any patent or patent rights of Wolfspeed.

©2017-2022 Wolfspeed, Inc. All rights reserved. Wolfspeed® and the Wolfstreak logo are registered trademarks and the Wolfspeed logo is a trademark of Wolfspeed, Inc.  
PATENT: <https://www.wolfspeed.com/legal/patents>

*The information in this document is subject to change without notice.*