

CFTVS5V0LC

**SURFACE MOUNT SILICON
UNI-DIRECTIONAL
TRANSIENT VOLTAGE SUPPRESSOR**



www.centrasemi.com



DESCRIPTION:

The CENTRAL SEMICONDUCTOR CFTVS5V0LC is an ultra low capacitance, low leakage, fast response TVS in the space saving SOD-882L surface mount package. This device is designed to protect sensitive equipment connected to high speed data lines against ESD damage.

MARKING CODE: 5

APPLICATIONS:

- High speed data line protection
- User interface protection
- Charging/power port protection

FEATURES:

- Space saving SOD-882L package
- Ultra low capacitance
- Low leakage current

MAXIMUM RATINGS: ($T_A=25^\circ\text{C}$)

Peak Power Dissipation (8x20 μs)
 Electrical Fast Transient (IEC 61000-4-4) (5x50ns)
 ESD Voltage (IEC 61000-4-2, Air)
 ESD Voltage (IEC 61000-4-2, Contact)
 Operating Junction Temperature
 Storage Temperature

SYMBOL

P_{PK} 12
 EFT 40
 V_{ESD} 15
 V_{ESD} 10
 T_J -55 to +125
 T_{stg} -55 to +150

UNITS

W
 A
 kV
 kV
 $^\circ\text{C}$
 $^\circ\text{C}$

ELECTRICAL CHARACTERISTICS: ($T_A=25^\circ\text{C}$) $V_F=1.0\text{V MAX @ } I_F=10\text{mA}$

Maximum Reverse Stand-off Voltage V_{RWM}	Minimum Breakdown Voltage $V_{BR @ I_T}$	Test Current I_T	Maximum Reverse Leakage Current $I_R @ V_{RWM}$	Maximum Clamping Voltage (8x20 μs) $V_C @ I_{PP}$		Typical TLP Clamping Voltage (Note 1) $V_{CL @ I_{PP}}$		Typical Dynamic Resistance (Note 1) R_{DYN}	Maximum Junction Capacitance @ 0V Bias C_J
				V	A	V	A		
5.0	6.0	1.0	1.0	12	1.0	5.0	4.0	0.96	0.9
						10	9.2		

Note 1: Transmission Line Pulse (TLP) conditions: $Z_0=50\Omega$, $t_p=100\text{ns}$

CFTVS5V0LC 
**SURFACE MOUNT SILICON
 UNI-DIRECTIONAL
 TRANSIENT VOLTAGE SUPPRESSOR**



SOD-882L CASE - MECHANICAL OUTLINE

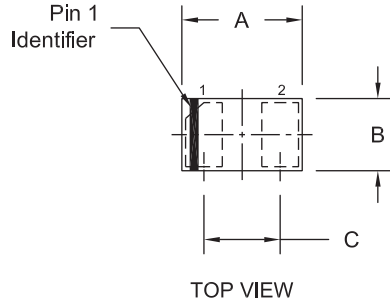

SYMBOL	INCHES		MILLIMETERS	
	MIN	MAX	MIN	MAX
A	0.037	0.041	0.95	1.05
B	0.022	0.026	0.55	0.65
C	0.026		0.65	
D	0.000	0.002	0.00	0.05
E	0.012	0.016	0.30	0.40
F	0.018	0.022	0.45	0.55
G	0.008	0.012	0.20	0.30

SOD-882L (REV:R2)

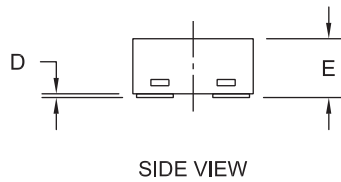

LEAD CODE:

- 1) Cathode
- 2) Anode

MARKING CODE: 5

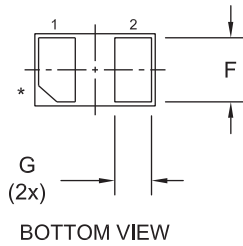

* Pin 1 chamfer may appear on any corner.

R2

R3 (16-October 2015)



CFTVS5V0LC
SURFACE MOUNT SILICON
UNI-DIRECTIONAL
TRANSIENT VOLTAGE SUPPRESSOR

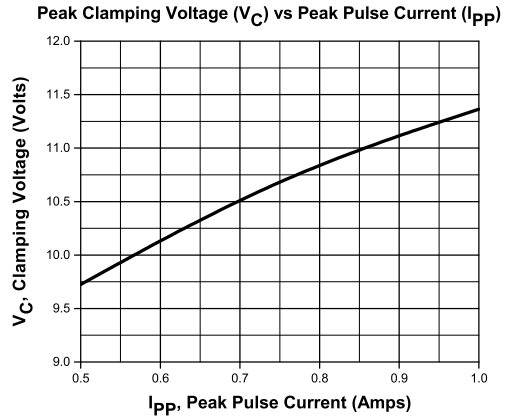
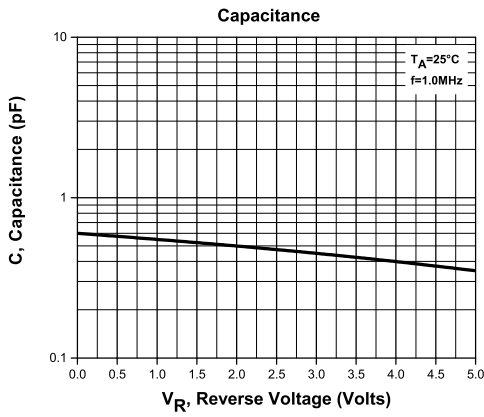
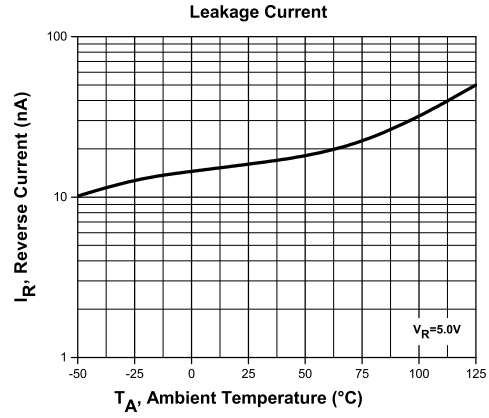
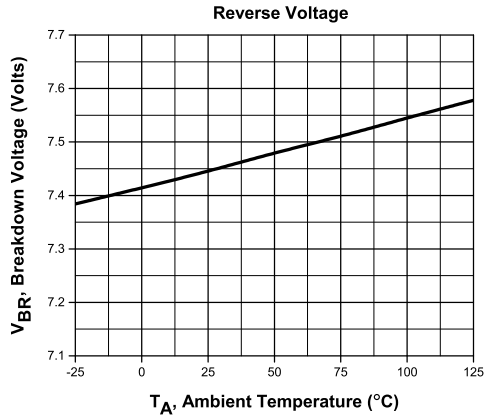

TYPICAL ELECTRICAL CHARACTERISTICS



R3 (16-October 2015)

CFTVS5V0LC
SURFACE MOUNT SILICON
UNI-DIRECTIONAL
TRANSIENT VOLTAGE SUPPRESSOR



TYPICAL ELECTRICAL CHARACTERISTICS

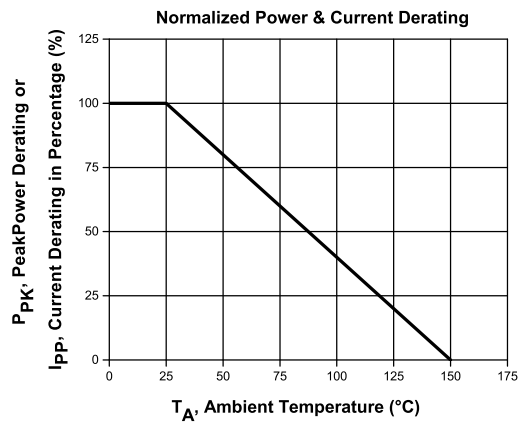
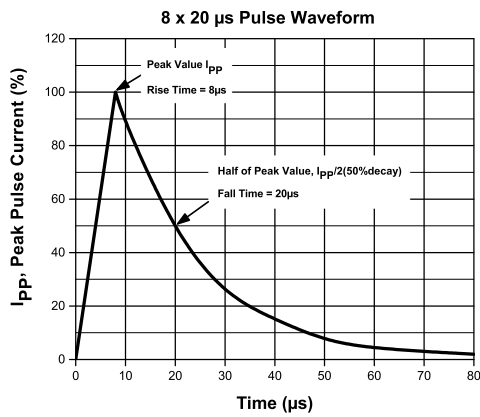
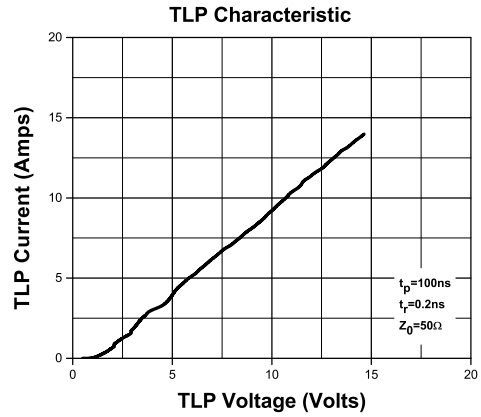
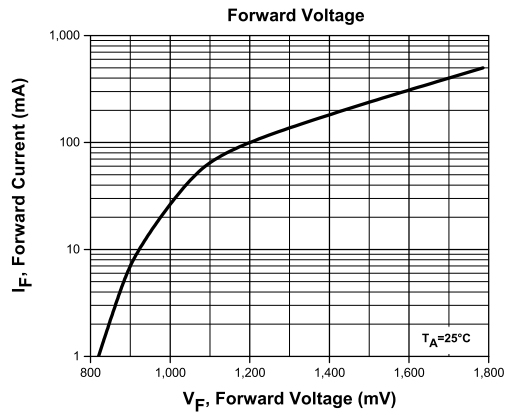

R3 (16-October 2015)

OUTSTANDING SUPPORT AND SUPERIOR SERVICES



PRODUCT SUPPORT

Central's operations team provides the highest level of support to insure product is delivered on-time.

- Supply management (Customer portals)
- Inventory bonding
- Consolidated shipping options
- Custom bar coding for shipments
- Custom product packing

DESIGNER SUPPORT/SERVICES

Central's applications engineering team is ready to discuss your design challenges. Just ask.

- Free quick ship samples (2nd day air)
- Online technical data and parametric search
- SPICE models
- Custom electrical curves
- Environmental regulation compliance
- Customer specific screening
- Up-screening capabilities
- Special wafer diffusions
- PbSn plating options
- Package details
- Application notes
- Application and design sample kits
- Custom product and package development

REQUESTING PRODUCT PLATING

1. If requesting Tin/Lead plated devices, add the suffix "TIN/LEAD" to the part number when ordering (example: 2N2222A TIN/LEAD).
2. If requesting Lead (Pb) Free plated devices, add the suffix "PBFREE" to the part number when ordering (example: 2N2222A PBFREE).

CONTACT US

Corporate Headquarters & Customer Support Team

Central Semiconductor Corp.
145 Adams Avenue
Hauppauge, NY 11788 USA
Main Tel: (631) 435-1110
Main Fax: (631) 435-1824
Support Team Fax: (631) 435-3388
www.centrasemi.com

Worldwide Field Representatives:
www.centrasemi.com/wwreps

Worldwide Distributors:
www.centrasemi.com/wwdistributors

For the latest version of Central Semiconductor's **LIMITATIONS AND DAMAGES DISCLAIMER**, which is part of Central's Standard Terms and Conditions of sale, visit: www.centrasemi.com/terms