

- 1
- 2
- 3
- 4
- 5
- 6
- 7
- 8
- 9
- 10
- 11
- 12
- 13
- 14
- 15
- 16
- 17
- 18

**MATERIAL**

Glass-fibre reinforced polyamide based (PA) technopolymer, black colour, matte finish.

**AJUSTABLE PIN WITH OCTAGONAL SLOT**

Acetal based (POM) technopolymer, black colour.

**SCREW-COVERS**

Polyester based (PBT) technopolymer, black colour, glossy finish, snap-in assembly.

**COVERS FOR PIN SLOT**

Technopolymer, black colour, matte finish; to be fitted after assembly.

**HINGE ASSEMBLY ON FRAME AND DOOR**

Pass-through holes for hexagonal head screws, cylindrical head screws with hexagon socket or M5 hexagonal nuts (UNI 5588).

**FEATURES AND APPLICATIONS**

CFO, offset lift-off hinges (ELESA patent) have been designed to adjust possible misalignments between the door and the frame.

They can be mounted on doors which open on the right or on the left side. Each body of the hinge has a slot for fitting the pin: the opposite side can be closed with the supplied cover.

**SPECIAL EXECUTIONS ON REQUEST**

Screw-covers in different RAL colours.

To choose the convenient type and the right number of hinges for your application, see the Guidelines (see page 1448).



FMM design

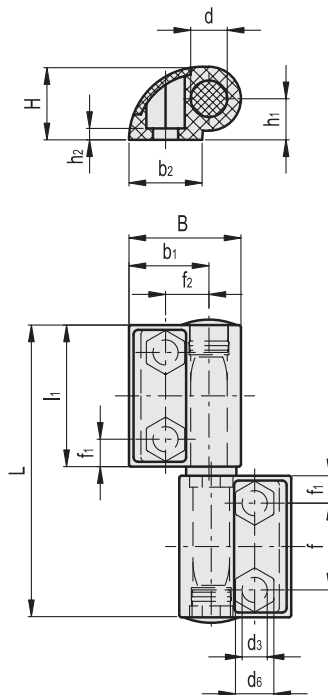
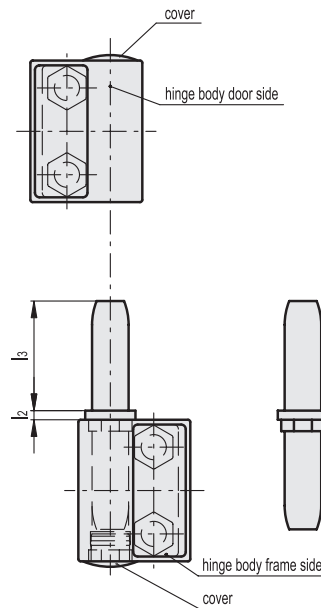
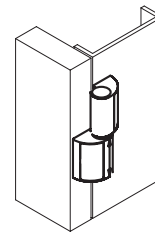

Conversion Table 1 mm = 0.039 inch			
L		d6	
mm	inch	mm	inch
64	2.52	8.5	0.33

Code	Description	L	B	f	f1	f2	H	h1	h2	l1	l2	l3	b1	b2	d	d3	d6	C# [Nm]	⚖
426211-C9	CFO.65 EH-5-C9	64	24.5	19	6	9.5	16	9	2.5	31	2	24	17.5	16	8	5.5	8.5	5	25

# Suggested tightening torque for assembly screws.

Resistance tests			
AXIAL STRESS		RADIAL STRESS	
Parallel planes	Perpendicular planes	Parallel planes	Perpendicular planes
Maximum working load $E_a$ [N]		Maximum working load $E_r$ [N]	
290		200	

The elastic deformation, which occurs on the hinge for values of load exceeding the ones indicated in the table, makes the load at breakage meaningless.

### ASSEMBLY INSTRUCTIONS

1. Fit the hinge bodies with octagonal slot on the frame and the other two bodies with cylindrical slot on the door.
2. Insert the pins with octagonal slot in the two bodies fitted on the frame by matching the indexes engraved on the pin and on the hinge.
3. Mount the door by matching the hinge bodies on the pins.

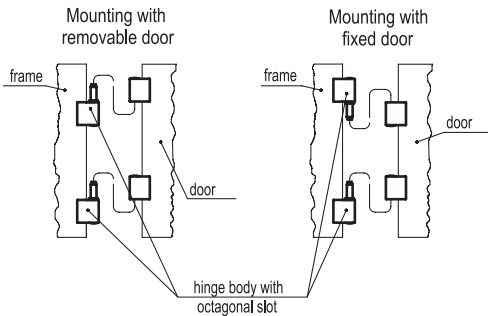
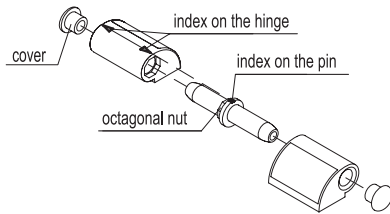

### OFF LINE ADJUSTMENTS

The pin has an octagonal slot which allows different positions for the adjustment of off line door (fig. 1-2-3-4). To have the door in line with the frame, it can be necessary to adjust the pins of both hinges.

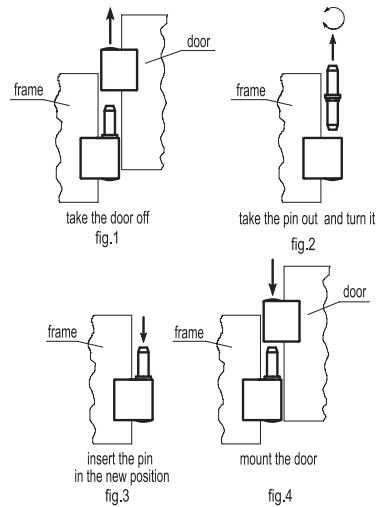

### ADJUSTMENT OF THE DOOR

In case the door is off line with the frame, the inclination of the door can be adjusted by turning the octagonal slot of the pins clockwise or anticlockwise.

By turning the pin anticlockwise, the distance  $S$  increases (+0.5) while by turning the pin clockwise, it decreases (-0.5).

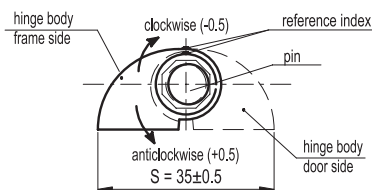

### ADJUSTMENT EXAMPLES

If the door is off line on the bottom side.

In order to have the door in line with the frame, turn the pin of hinge 1 anticlockwise by 45° or 90° and the pin of hinge 2 clockwise.

If the door is off line on the top side.

In order to have the door in line with the frame, turn the pin of hinge 1 clockwise by 45° or 90° and the pin of hinge 2 anticlockwise.

