

CDSUR4148S-HF

RoHS Device
Halogen Free

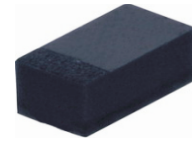

Features

- High Speed.
- Designed for mounting on small surface.
- Extremely thin/leadless package.
- High mounting capability, strong surge withstand, high reliability.

Mechanical data

- Case: 0603/SOD-523F standard package, molded plastic.
- Terminals: Gold plated, solderable per MIL-STD-750, method 2026.
- Polarity: Indicated by cathode band.
- Mounting position: Any.
- Weight: 0.003 grams (approx.).

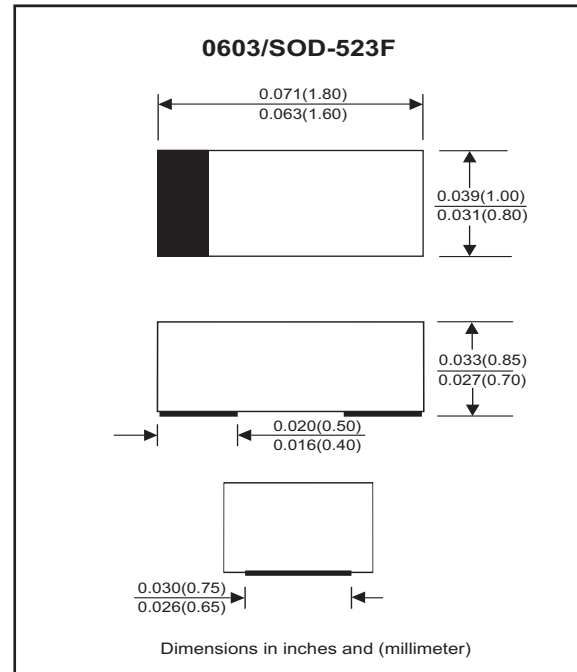

Circuit diagram



Maximum Rating (at $T_A=25^\circ\text{C}$ unless otherwise noted)

Parameter	Conditions	Symbol	Min	Typ	Max	Unit
Repetitive peak reverse voltage		V_{RRM}			100	V
Reverse voltage		V_R			100	V
Average forward current		I_o			150	mA
Forward current, surge peak	$T_p=8.3\text{ms}$	I_{FSM}		1.5		A
Repetitive peak forward current		I_{FRM}			300	mA
Power dissipation		P_D			150	mW
Operating temperature range		T_j	-55		+150	$^\circ\text{C}$
Storage temperature range		T_{STG}	-55		+150	$^\circ\text{C}$

Electrical Characteristics (at $T_A=25^\circ\text{C}$ unless otherwise noted)

Parameter	Conditions	Symbol	Min	Typ	Max	Unit
Forward voltage	$I_F = 100\text{ mA DC}$	V_F			1.0	V
Reverse current	$V_R = 20\text{V}$ $V_R = 75\text{V}$	I_R			25 2.5	nA uA
Capacitance between terminals	$f = 1\text{MHz}$, and 0 VDC reverse voltage	C_T			3	pF
Reverse recovery time	$I_F = I_R = 10\text{ mA}$, $R_L = 100\text{ ohms}$, $I_{rr} = 1\text{ mA}$	T_{rr}			4	nS

RATING AND CHARACTERISTIC CURVES (CDSUR4148S-HF)

Fig.1 - Forward Characteristics

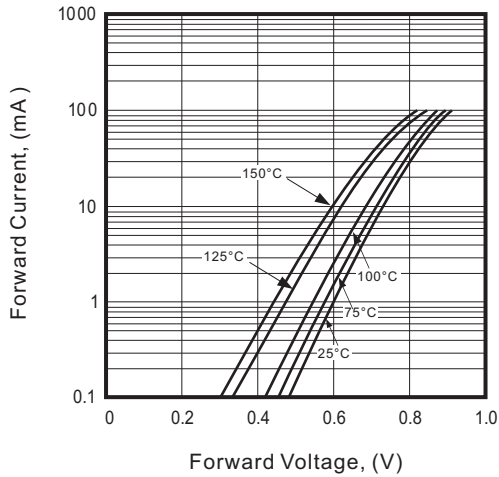

Fig.2 - Reverse Characteristics

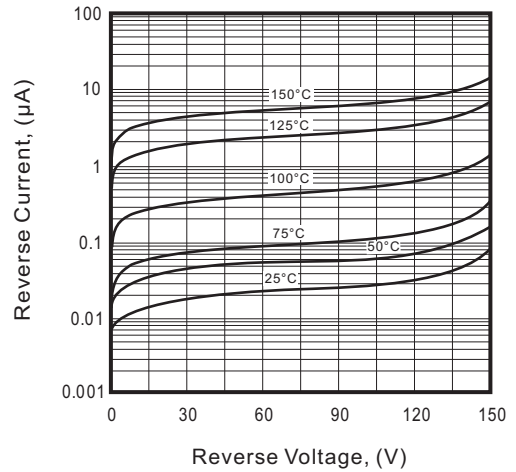

Fig.3 - Capacitance Between Terminals Characteristics

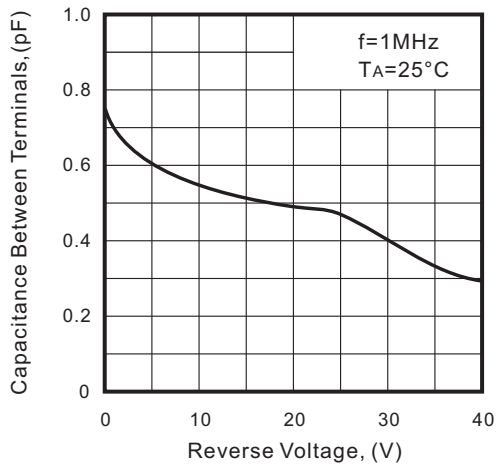
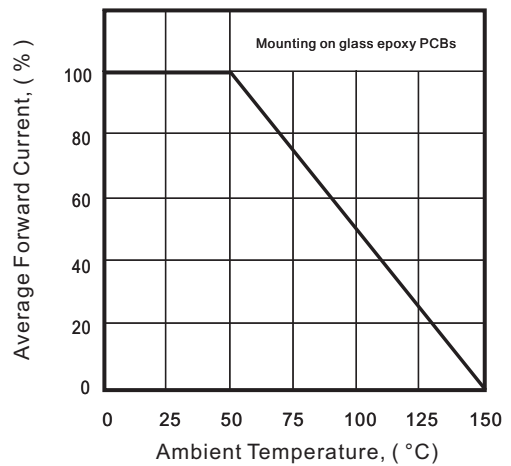
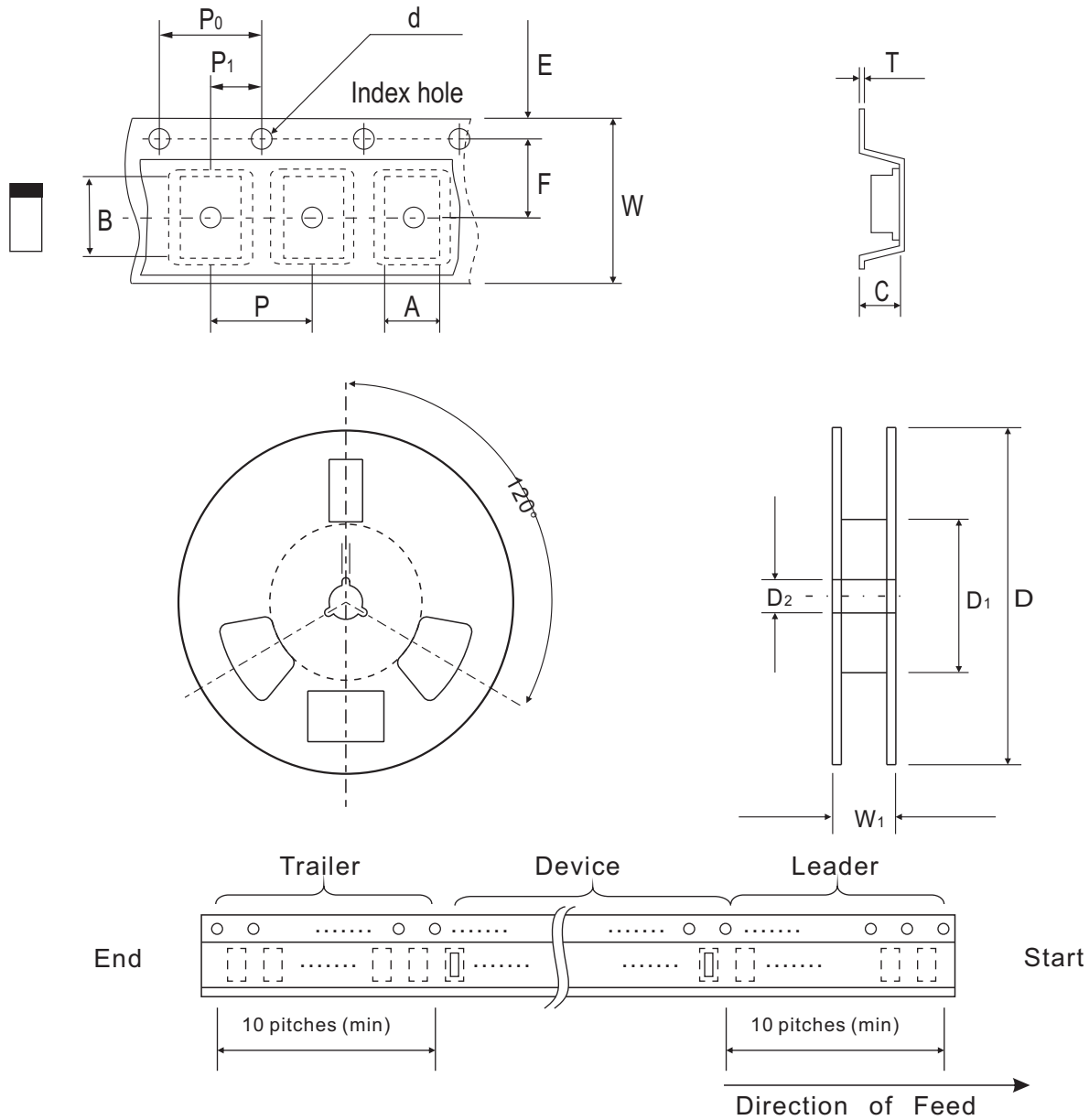

Fig.4 - Current Derating Curve



Reel Taping Specification



0603 (SOD-523F)	SYMBOL	A	B	C	d	D	D ₁	D ₂
	(mm)	1.00 ± 0.10	1.85 ± 0.10	1.00 ± 0.10	1.55 ± 0.10	178 ± 1.00	60.0 MIN.	13.0 ± 0.20
	(inch)	0.039 ± 0.004	0.073 ± 0.004	0.039 ± 0.004	0.061 ± 0.004	7.008 ± 0.04	2.362 MIN.	0.512 ± 0.008

0603 (SOD-523F)	SYMBOL	E	F	P	P ₀	P ₁	T	W	W
	(mm)	1.75 ± 0.10	3.50 ± 0.05	4.00 ± 0.10	4.00 ± 0.10	2.00 ± 0.10	0.23 ± 0.05	8.00 ± 0.20	13.50 MAX.
	(inch)	0.069 ± 0.004	0.138 ± 0.002	0.157 ± 0.004	0.157 ± 0.004	0.079 ± 0.004	0.009 ± 0.002	0.315 ± 0.008	0.531 MAX.

Suggested PAD Layout

SIZE	0603/SOD-523F	
	(mm)	(inch)
A	1.25	0.049
B	0.60	0.024
C	1.00	0.039
D	1.85	0.073
E	0.65	0.026

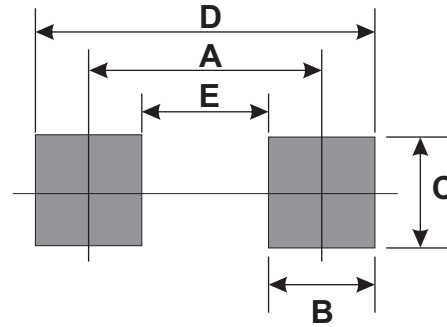

Standard Packaging

Case Type	Qty Per Reel	Reel Size
	(Pcs)	(inch)
0603/SOD-523F	4,000	7