

CDB5461AU Evaluation Board & Software

Features

- Voltage and Current Interface
- USB communication with PC
- On-board C8051F320 microcontroller
- On-board Voltage Reference
- Lab Windows® / CVI™ Evaluation Software
 - Register Setup & Chip Control
 - FFT Analysis
 - Time Domain Analysis
 - Noise Histogram Analysis
- "Auto-boot" Demo with serial EEPROM
 - Collected by On-board Microcontroller
 - Available on External Header

General Description

The CDB5461AU is an inexpensive tool designed to evaluate the functionality and performance of the CS5461A. The evaluation board includes an LT1019 voltage reference, a C8051F320 microcontroller with a USB interface, and firmware. The microcontroller controls the serial communication between the evaluation board and the PC via the firmware, enabling quick and easy access to all of the CS5461A's registers and functions.

The CDB5461A includes software for Data Capture, Time Domain Analysis, Histogram Analysis, and Frequency Domain Analysis.

ORDERING INFORMATION

CDB5461AU Evaluation Board

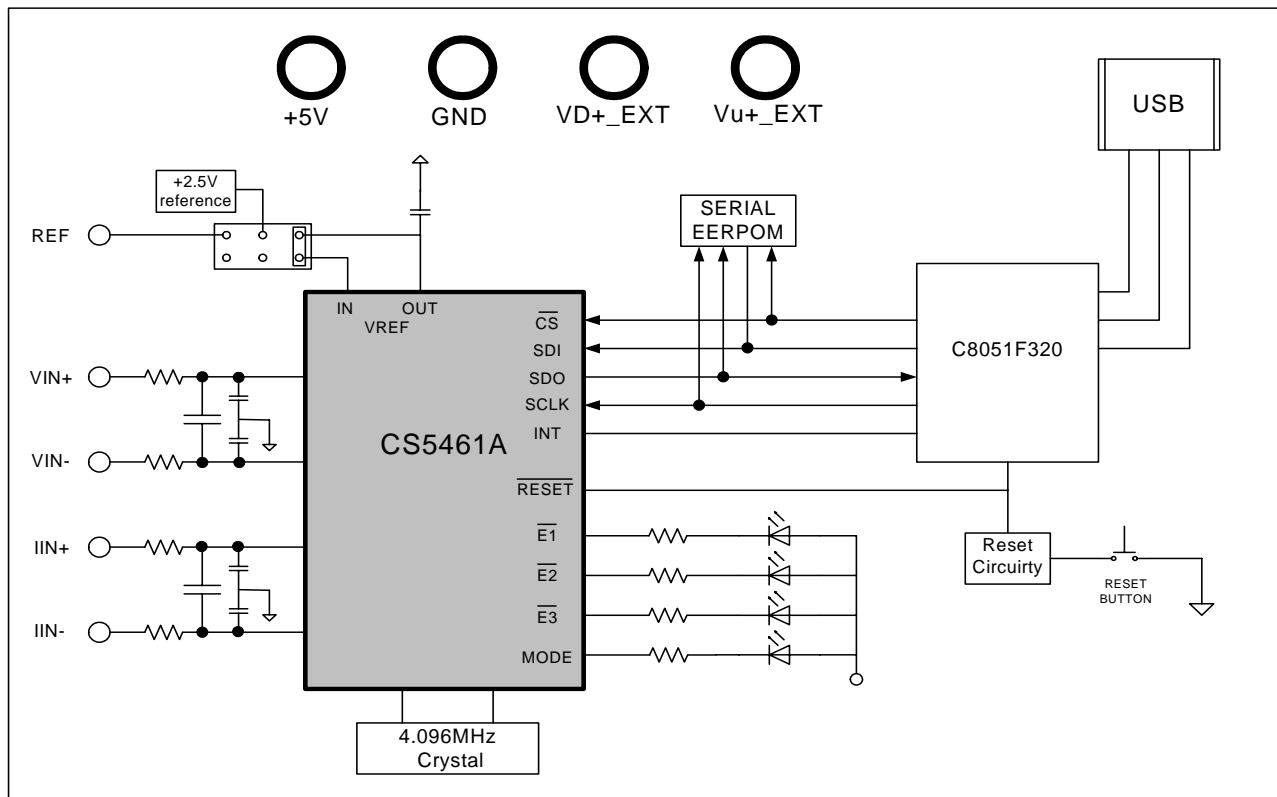

TABLE OF CONTENTS

– TABLE OF CONTENTS	2
– LIST OF FIGURES	3
– LIST OF TABLES	3
1. HARDWARE	4
1.1 Introduction	4
1.2 Evaluation Board Overview	4
1.2.1 Analog Section	5
1.2.2 Digital Section	6
1.2.3 Power Supply Section	7
1.3 Auto-boot Mode	8
2. SOFTWARE	9
2.1 Installation Procedure	9
2.2 Using the Software	9
2.3 Start-Up Window	9
2.3.1 Setup	10
2.3.2 Quit	11
2.3.3 Menu	12
2.4 Setup Window	12
2.4.1 Refresh Screen Button	13
2.4.2 Reset DUT Button	13
2.4.3 CS5461A Crystal Frequency	13
2.4.4 Configuration Register Panel	14
2.4.5 Mask Register/Status Register Panel	14
2.4.6 Cycle Count / PulseRateE / PulseWidth / VSAGlevel / VSAGduration Registers	14
2.4.7 Control Register	14
2.5 Calibration Window	15
2.5.1 Offset & Gain Registers	15
2.5.2 Performing Calibrations	15
2.6 Conversion Window	17
2.6.1 Single Conversion Button	17
2.6.2 Continuous Conversion Button	17
2.6.3 Standby & Sleep Mode Buttons	17
2.6.4 Power Up Button	18
2.6.5 Temperature Settings Window	18
2.6.6 Write Data to File Window	18
2.7 Pulse Rate Window	18
2.7.1 Integration Seconds Field	18
2.7.2 Periods to Average Field	18
2.7.3 Start Button	19
2.8 Data Collection Window	19
2.8.1 Time Domain / FFT / Histogram Pull-down	19
2.8.2 Config Button	19
2.8.3 Collect Button	20
2.8.4 Output Button	20
2.8.5 Zoom Button	20
2.8.6 Channel Select Button	20
2.8.7 Config Window	20
2.8.8 Collecting Data Sets	21
2.8.9 Retrieving Saved Data from a File	21
2.8.10 Analyzing Data	21
2.8.11 Histogram Information	22
2.8.12 Frequency Domain Information	24

2.8.13 Time Domain Information	25
2.9 EEPROM Window	26
2.9.1 Read EEPROM	26
2.9.2 Write EEPROM	26
2.9.3 Debug Window	26
3. SCHEMATICS	28
4. LAYOUT	32

LIST OF FIGURES

Figure 1. CDB5461AU Assembly Drawing.....	4
Figure 2. CDB5461AU Start-up Window.....	9
Figure 3. Establishing a USB Connection	10
Figure 4. USB Error Message	10
Figure 5. Selecting a Data File for Further Analysis.....	11
Figure 6. Quit Window.....	11
Figure 7. <i>Menu</i> Pull-down Options.....	12
Figure 8. <i>Setup</i> Window.....	13
Figure 9. Calibration Window	15
Figure 10. <i>Conversion</i> Window.....	17
Figure 11. Pulse Rate Output Window.....	18
Figure 12. Data Collection Window.....	19
Figure 13. Histogram Analysis	22
Figure 14. FFT Analysis	24
Figure 15. Time Domain Analysis	25
Figure 16. <i>EEPROM</i> Window.....	26
Figure 17. <i>Debug</i> Window.....	27
Figure 18. Analog Inputs	28
Figure 19. CS546x and Socket	29
Figure 20. Microcontroller and USB Interface	30
Figure 21. Power Supplies	31
Figure 22. Top Silk Screen.....	32
Figure 23. Topside Layer	33
Figure 24. Bottomside Layer	34
Figure 25. Bottom Silk Screen	35

LIST OF TABLES

Table 1. Internal Voltage Reference Selection for VREF.....	5
Table 2. External Voltage Reference Selection for VREF.....	5
Table 3. Voltage and Current Channel Input Signal Selection.....	6
Table 4. Power Supply Connections	7

1.2.1 Analog Section

The CDB5461AU evaluation board provides screw-type terminals (J23, J27) to connect input signals to the voltage and current channels. The screw terminals are labels as VIN+, VIN-, IIN+, and IIN-. A simple R-C network at each channel input provides a simple anti-alias filter.

The evaluation board provides three voltage reference options for VREFIN to the CS5461A. The three voltage reference options include: VREFOUT from CS5461A, the on-board +2.5V reference, and external REF+ (screw terminal J14). Table 1 and Table 2 illustrate the options available for VREFIN. With a jumper on J25 in the position labeled VREFOUT, the reference is supplied by the on-chip voltage reference. With a jumper on J25 in the position labeled VREF, the reference is supplied by an off-chip voltage reference.

Reference	Description	J25
VREFOUT	Selects on-Chip Reference (25ppm/°C)	VREF <input type="radio"/> VREFIN <input checked="" type="radio"/> VREFOUT <input type="radio"/> (Default)
VREF	Selects External or LT1019 Reference(J12)	VREF <input checked="" type="radio"/> VREFIN <input type="radio"/> VREFOUT <input type="radio"/>

Table 1. Internal Voltage Reference Selection for VREF

Table 2 illustrates the options available for VREF. With a jumper on J12 in position LT1019, the LT1019 provides a +2.5V reference (the LT1019 was chosen for its low drift - typically 5ppm/°C). By setting the jumper on J12 to position REF+, an external voltage reference is supplied via screw terminal J14's REF+ input.

Reference	Description	J12
LT1019	Selects on-Board LT1019 Reference (5ppm/°C)	LT1019 <input checked="" type="radio"/> VREF REF+ <input type="radio"/> VREF
REF+	Selects External Reference Source (J6)	LT1019 <input type="radio"/> VREF REF+ <input checked="" type="radio"/> VREF (Default)

Table 2. External Voltage Reference Selection for VREF

The three input signal options for the voltage (VIN±) and current (IIN±) channel input include: an external signal (screw terminals J23 and J27), GND or VREF. Table 3 illustrates the options available. By installing jumpers on J17 to position VIN+, J22 to position VIN-, J24 to position IIN+ and J26 to position IIN-, the input voltage signal is supplied from the screw terminals J23 and J27. With a jumper on J17, J22, J24 and J26 in the GND position, the inputs are connected to analog ground (AGND). With a jumper on J17, J22, J24 and J26 in position VREF, the inputs are connected to the reference voltage selected on J12.

INPUT	Description	J17	J22	J24	J26
VIN± or IIN±	Selects External Signal	GND <input type="checkbox"/> <input type="checkbox"/> VIN+ VREF <input type="checkbox"/> <input type="checkbox"/> VIN+ VIN+ <input checked="" type="checkbox"/> <input checked="" type="checkbox"/> VIN+ <i>(Default)</i>	VIN- <input type="checkbox"/> <input type="checkbox"/> VIN- VREF <input type="checkbox"/> <input type="checkbox"/> VIN- GND <input checked="" type="checkbox"/> <input checked="" type="checkbox"/> VIN- <i>(Default)</i>	GND <input type="checkbox"/> <input type="checkbox"/> IIN+ VREF <input type="checkbox"/> <input type="checkbox"/> IIN+ IIN+ <input checked="" type="checkbox"/> <input checked="" type="checkbox"/> IIN+ <i>(Default)</i>	IIN- <input type="checkbox"/> <input type="checkbox"/> IIN- VREF <input type="checkbox"/> <input type="checkbox"/> IIN- GND <input checked="" type="checkbox"/> <input checked="" type="checkbox"/> IIN- <i>(Default)</i>
VIN± or IIN±	Selects External Signal	GND <input type="checkbox"/> <input type="checkbox"/> VIN+ VREF <input type="checkbox"/> <input type="checkbox"/> VIN+ VIN+ <input checked="" type="checkbox"/> <input checked="" type="checkbox"/> VIN+	VIN- <input checked="" type="checkbox"/> <input checked="" type="checkbox"/> VIN- VREF <input type="checkbox"/> <input type="checkbox"/> VIN- GND <input type="checkbox"/> <input type="checkbox"/> VIN-	GND <input type="checkbox"/> <input type="checkbox"/> IIN+ VREF <input type="checkbox"/> <input type="checkbox"/> IIN+ IIN+ <input checked="" type="checkbox"/> <input checked="" type="checkbox"/> IIN+	IIN- <input checked="" type="checkbox"/> <input checked="" type="checkbox"/> IIN- VREF <input type="checkbox"/> <input type="checkbox"/> IIN- GND <input type="checkbox"/> <input type="checkbox"/> IIN-
GND	Selects Grounding the Input	GND <input checked="" type="checkbox"/> <input checked="" type="checkbox"/> VIN+ VREF <input type="checkbox"/> <input type="checkbox"/> VIN+ VIN+ <input type="checkbox"/> <input type="checkbox"/> VIN+	VIN- <input type="checkbox"/> <input type="checkbox"/> VIN- VREF <input type="checkbox"/> <input type="checkbox"/> VIN- GND <input checked="" type="checkbox"/> <input checked="" type="checkbox"/> VIN-	GND <input checked="" type="checkbox"/> <input checked="" type="checkbox"/> IIN+ VREF <input type="checkbox"/> <input type="checkbox"/> IIN+ IIN+ <input type="checkbox"/> <input type="checkbox"/> IIN+	IIN- <input type="checkbox"/> <input type="checkbox"/> IIN- VREF <input type="checkbox"/> <input type="checkbox"/> IIN- GND <input checked="" type="checkbox"/> <input checked="" type="checkbox"/> IIN-
VREFIN	Selects Reference Source	GND <input type="checkbox"/> <input type="checkbox"/> VIN+ VREF <input checked="" type="checkbox"/> <input checked="" type="checkbox"/> VIN+ VIN+ <input type="checkbox"/> <input type="checkbox"/> VIN+	VIN- <input type="checkbox"/> <input type="checkbox"/> VIN- VREF <input checked="" type="checkbox"/> <input checked="" type="checkbox"/> VIN- GND <input type="checkbox"/> <input type="checkbox"/> VIN-	GND <input type="checkbox"/> <input type="checkbox"/> IIN+ VREF <input checked="" type="checkbox"/> <input checked="" type="checkbox"/> IIN+ IIN+ <input type="checkbox"/> <input type="checkbox"/> IIN+	IIN- <input type="checkbox"/> <input type="checkbox"/> IIN- VREF <input checked="" type="checkbox"/> <input checked="" type="checkbox"/> IIN- GND <input type="checkbox"/> <input type="checkbox"/> IIN-

Table 3. Voltage and Current Channel Input Signal Selection

1.2.2 Digital Section

The digital section contains the microcontroller, USB interface, JTAG header, reset circuitry, and an external interface header (J40). The microcontroller interfaces the SPI of CS5461A with the USB connection to the PC, enabling GUI software to access all the CS5461A registers and functions. Interface header, J40, is provided to allow the CDB5461AU to be connected to an external energy registration device or an external microcontroller. To connect the CS5461A to an external microcontroller, R59, R60, R61, and R62 must be removed from the board. The energy output pins *E1*, *E2*, and *E3* are routed to LEDs which provide a simple visual check of the energy output pulses. The *Mode* pin is also routed to an LED to indicate whether the CS5461A is in auto-boot mode. Jumpers J10, J13, J15, and J16 are equipped at the factory with jumpers to enable the LEDs.

1.2.3 Power Supply Section

Table 4 illustrates the power supply connections to the evaluation board. The +5V binding post (J3) supplies the positive analog (VA+) for the CS5461A and the +2.5V reference. The VD+_EXT binding post (J5) supplies the digital section of the CS5461A (VD+) and level shifters. Jumper J8 allows the VD+ supply to be sourced from the VD+_EXT binding post (J5), the +5V binding post (J3), or the regulated 3.3V supply derived from the microcontroller. The VU+_EXT (J6) binding post supplies the positive supply for the 8051 microcontroller (8051_REGIN). Jumper J9 allows the 8051_REGIN supply to be sourced from either the VU+_EXT binding post (J6), +5V binding post (J3) or VD+_EXT binding post (J5).

Power Supplies			Power Post Connections				VD+	8051-REGIN	
Analog (VA+)	Digital (VD+)	8051 (Vu+)	+5V	GND	VD+EXT	VU+EXT	J8	J9	
+5	+5	+5	+5	0	NC	NC	VD+_EXT <input type="checkbox"/> <input type="radio"/> VD+ +5 <input checked="" type="radio"/> <input type="radio"/> VD+ +3.3 <input type="radio"/> <input type="radio"/> VD+ <i>(Default)</i>	VU+_EXT <input type="checkbox"/> <input type="radio"/> 8051 +5 <input checked="" type="radio"/> <input type="radio"/> 8051 VD+ <input type="radio"/> <input type="radio"/> 8051 <i>(Default)</i>	
							+5	VD+_EXT <input type="checkbox"/> <input type="radio"/> VD+ +5 <input checked="" type="radio"/> <input type="radio"/> VD+ +3.3 <input type="radio"/> <input type="radio"/> VD+	VU+_EXT <input checked="" type="radio"/> 8051 +5 <input type="radio"/> <input type="radio"/> 8051 VD+ <input type="radio"/> <input type="radio"/> 8051
							NC	VD+_EXT <input type="checkbox"/> <input type="radio"/> VD+ +5 <input checked="" type="radio"/> <input type="radio"/> VD+ +3.3 <input type="radio"/> <input type="radio"/> VD+	VU+_EXT <input type="checkbox"/> <input type="radio"/> 8051 +5 <input type="radio"/> <input type="radio"/> 8051 VD+ <input checked="" type="radio"/> 8051
					+5	NC	VD+_EXT <input checked="" type="radio"/> VD+ +5 <input type="radio"/> <input type="radio"/> VD+ +3.3 <input type="radio"/> <input type="radio"/> VD+	VU+_EXT <input type="checkbox"/> <input type="radio"/> 8051 +5 <input checked="" type="radio"/> <input type="radio"/> 8051 VD+ <input type="radio"/> <input type="radio"/> 8051	
							+5	VD+_EXT <input checked="" type="radio"/> VD+ +5 <input type="radio"/> <input type="radio"/> VD+ +3.3 <input type="radio"/> <input type="radio"/> VD+	VU+_EXT <input checked="" type="radio"/> 8051 +5 <input type="radio"/> <input type="radio"/> 8051 VD+ <input type="radio"/> <input type="radio"/> 8051
								NC	VD+_EXT <input checked="" type="radio"/> VD+ +5 <input type="radio"/> <input type="radio"/> VD+ +3.3 <input type="radio"/> <input type="radio"/> VD+
+5	+3.3	+5	+5	0	NC	NC	VD+_EXT <input type="checkbox"/> <input type="radio"/> VD+ +5 <input type="radio"/> <input type="radio"/> VD+ +3.3 <input checked="" type="radio"/> <input type="radio"/> VD+	VU+_EXT <input type="checkbox"/> <input type="radio"/> 8051 +5 <input checked="" type="radio"/> <input type="radio"/> 8051 VD+ <input type="radio"/> <input type="radio"/> 8051	
							+5	VD+_EXT <input type="checkbox"/> <input type="radio"/> VD+ +5 <input type="radio"/> <input type="radio"/> VD+ +3.3 <input checked="" type="radio"/> <input type="radio"/> VD+	VU+_EXT <input checked="" type="radio"/> 8051 +5 <input type="radio"/> <input type="radio"/> 8051 VD+ <input type="radio"/> <input type="radio"/> 8051
					+3.3	NC	VD+_EXT <input checked="" type="radio"/> VD+ +5 <input type="radio"/> <input type="radio"/> VD+ +3.3 <input type="radio"/> <input type="radio"/> VD+	VU+_EXT <input type="checkbox"/> <input type="radio"/> 8051 +5 <input checked="" type="radio"/> <input type="radio"/> 8051 VD+ <input type="radio"/> <input type="radio"/> 8051	
							+5	VD+_EXT <input checked="" type="radio"/> VD+ +5 <input type="radio"/> <input type="radio"/> VD+ +3.3 <input type="radio"/> <input type="radio"/> VD+	VU+_EXT <input checked="" type="radio"/> 8051 +5 <input type="radio"/> <input type="radio"/> 8051 VD+ <input type="radio"/> <input type="radio"/> 8051

Table 4. Power Supply Connections

1.3 Auto-boot Mode

With a jumper connection on J18 (AUTO-BOOT ENABLE), the CS5461A operates in auto-boot mode and the CDB5461AU board operates in a stand-alone manner without connecting to a PC. When in auto-boot mode, a hardware reset (pressing on S1) will cause the CS5461A to boot up using the serial data from the serial EEPROM on the board (U10). When the CS5461A is in auto-boot mode, the SPI connections between the microcontroller and the CS5461A are removed and GUI software can not access the CS5461A registers and functions.

The EEPROM must be programmed prior to the auto-boot sequence. When the CDB5461AU Evaluation Board is sent from the factory, the EEPROM is programmed with the following CS5461A command/data sequence:

- 40 00 00 61
- Set configuration Register, turn high-pass filters on, set K = 1;
- 4C 00 7D 00
- Set PulseRateE1,2 Register to 1000 Hz;
- 74 00 00 04
- Unmask bit #2 (LSD) in the Mask Register
- E8
- Start continuous conversion
- 78 00 01 00
- Write to the STOP bit in the Control Register, to terminate auto-boot sequence.

This sequence programs the CS5461A for continuous conversion mode. If voltage and current signals are applied to the inputs, the CS5461A will issue pulses on the /E1, /E2 and /E3 pins. See the CS5460A data sheet for more details on auto-boot.

2. SOFTWARE

The evaluation board comes with software and an USB cable to link the evaluation board to the PC. The evaluation software was developed with Lab Windows®/CVI™, a software development package from national Instruments. The evaluation software is available for download on the Cirrus Logic web site at <http://www.cirrus.com/industrial-software> and was designed to run under Windows 2000™ or Windows XP®.

2.1 Installation Procedure

To install the software, go to the Cirrus Logic web site at <http://www.cirrus.com/industrialsoftware> and refer to application note AN278.

2.2 Using the Software

Before launching the software, check all jumper settings on the CDB5461AU evaluation board as described in section 1, and connect the board to an open USB port on the PC using the provided cable. Once the board is powered on, the software program can be launched.

2.3 Start-Up Window

When the software is launched, the Start-Up window will appear. This window contains information concerning the software's title, revision number, copyright date, etc. See Figure 2.

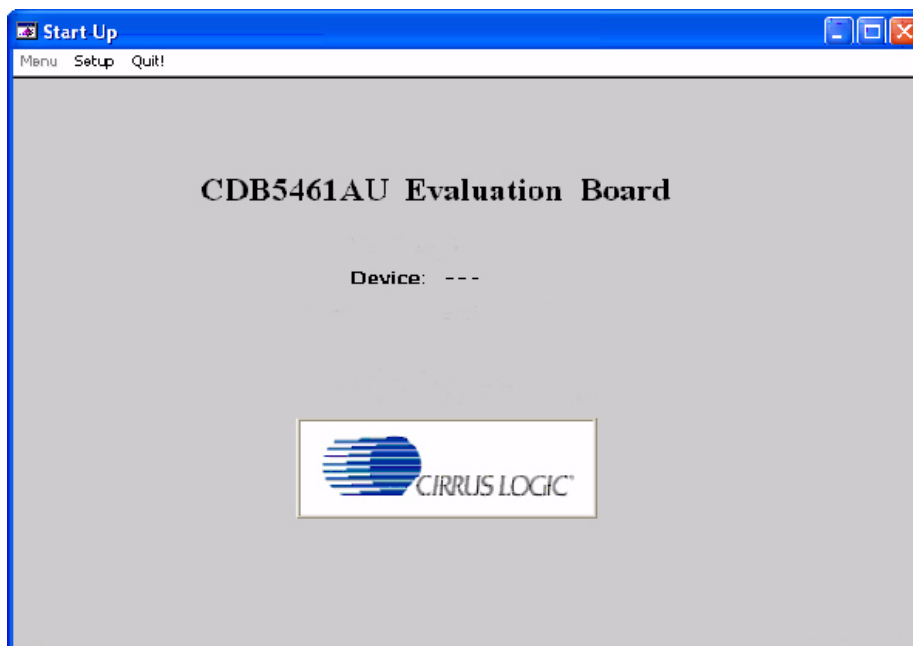

Figure 2. CDB5461AU Start-up Window

At the top of the screen is a menu bar which displays user options. The menu bar has three items: *Menu*, *Setup*, and *Quit*. Initially *Menu* is disabled. After establishing a link to a data source the *Menu* item will become available.

2.3.1 Setup

Setup allows user to establish a USB communication connection with CDB5461AU board or select a pre-saved data file for further analysis.

If the USB is selected, the evaluation software will poll the CDB5461AU, verifying the serial communication link is ready. At this point USB is checked indicating that the PC has successfully communicated with CDB5461AU evaluation board, and device and micro-code version information are read from the board and displayed on the screen. See Figure 3.

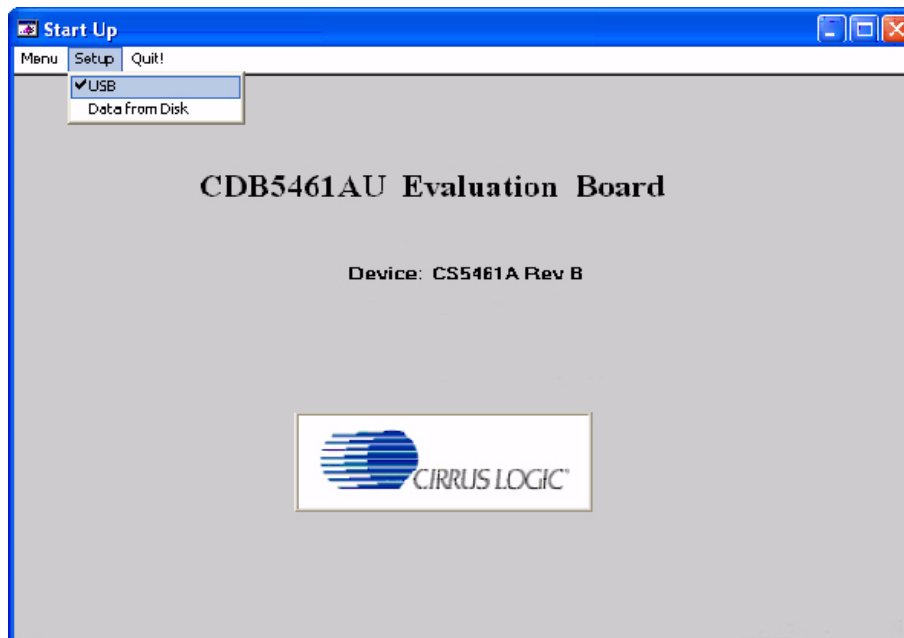

Figure 3. Establishing a USB Connection

If the evaluation software is unable to establish a communication link with CDB5461AU an error message will appear, indicating that the initial communication has failed. See Figure 6.

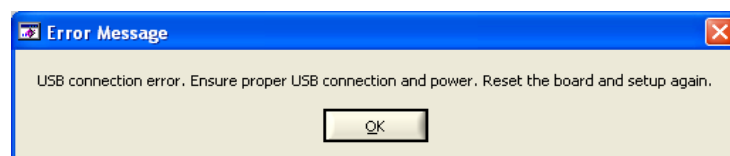

Figure 4. USB Error Message

Check to verify that the USB cable is connected properly and the power supply is on and connected properly to the CDB5461U. Reset the board (press the RESET button on the board) and try to setup USB again.

If *Data from Disk* is selected, a file selection window will appear as shown in Figure 5. The user can select a pre-saved data file for further analysis using time domain, FFT, and histogram plots in the *Data Collection* window of the software.

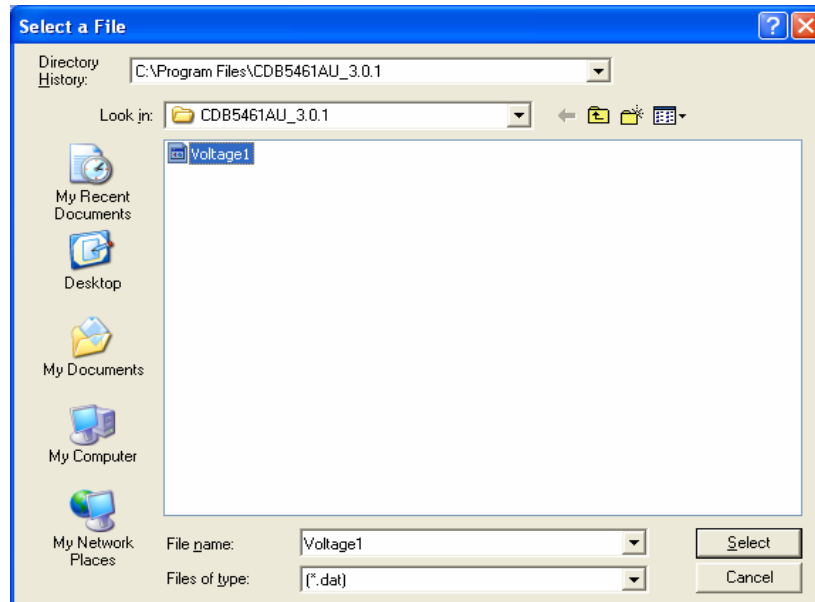

Figure 5. Selecting a Data File for Further Analysis

2.3.2 Quit

Quit allows the user to exit the evaluation software. Upon selecting *Quit*, a message windows appears that verifies whether exiting the evaluation software is desired. See Figure 6.

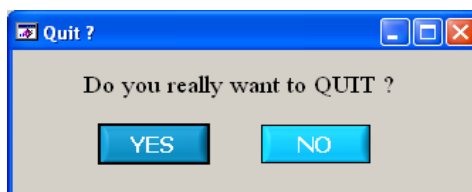

Figure 6. Quit Window

2.3.3 Menu

Except for the *Start-up* window, *Menu* allows 7 selection options, Setup window, Calibration window, Conversion window, Pulse Rate window, Data Collection window, EEPROM window and Debug window. Each window provides a means to evaluate the different functionalities and performances of the CS5461A. See Figure 7.

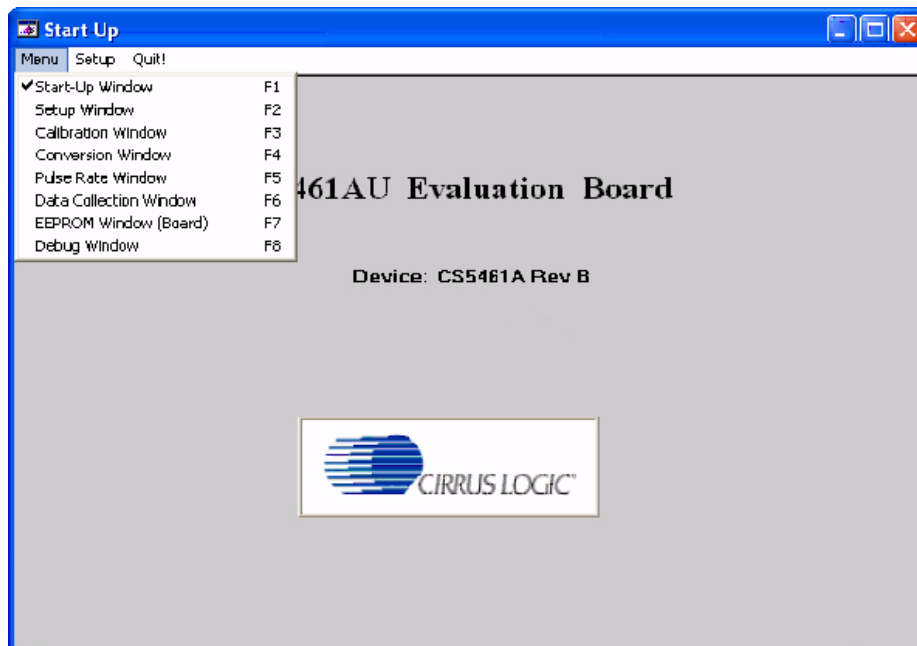

Figure 7. Menu Pull-down Options

2.4 Setup Window

The evaluation software provides access to the CS5461A's internal registers in the *Setup* window (Figure 8). The user can enter the *Setup* window by pulling down *Menu* and selecting the *Setup Window* menu item, or by pressing <F2> on the keyboard.

In the *Setup* window, all of the CS5461A's registers are displayed in hexadecimal notation, and also decoded to provide easier readability. Refer to the CS5461A data sheet for information on register functionality and descriptions.

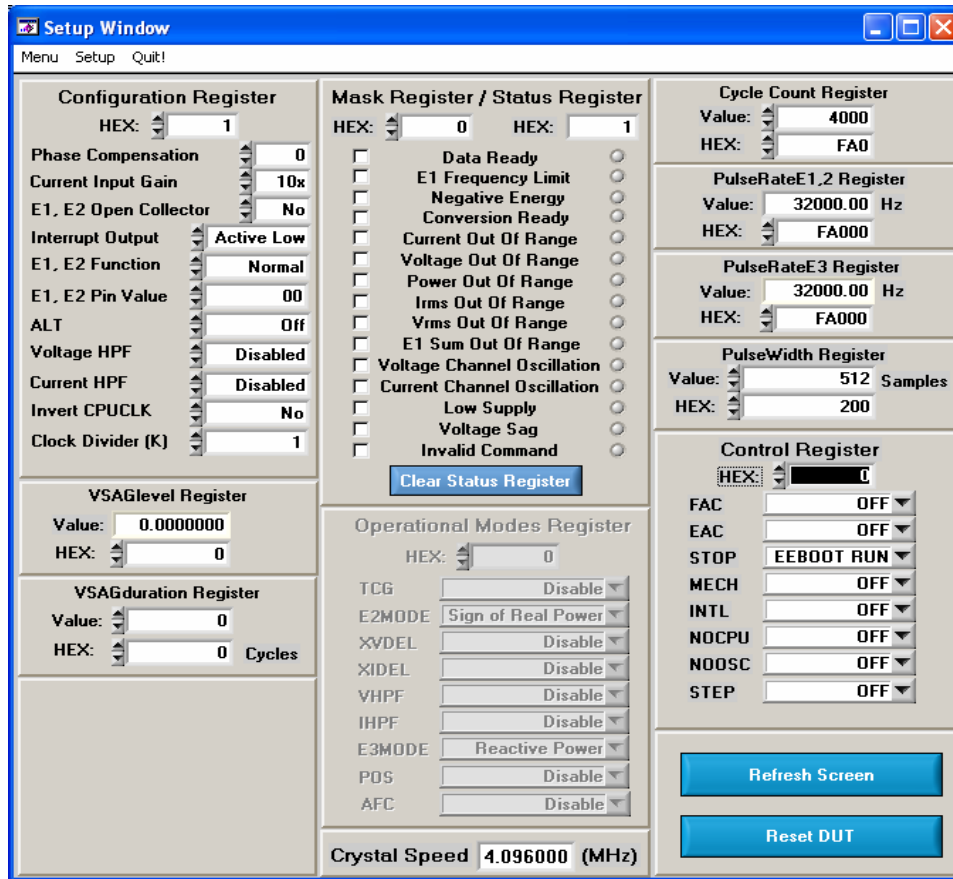

Figure 8. Setup Window

2.4.1 Refresh Screen Button

The *Refresh Screen* button will update the contents of the screen by reading all the register values from the CS5461A device. It is a good idea to press the *Refresh Screen* button when entering the *Setup* window, or after modifying any registers to reflect the current status of the device.

2.4.2 Reset DUT Button

The *Reset DUT* button will hardware reset the CS5461A. The CS5461A will perform a reset as discussed in the CS5461A data sheet. After the hardware reset to CS5461A, the screen contents will be automatically refreshed with the updated status of the CS5461A device.

2.4.3 CS5461A Crystal Frequency

The CS5461A accepts a wide range of crystal input frequencies, and can therefore run at many different sample rates. The crystal frequency being used on the CS5461A should be entered in this field to provide accurate frequency calculation in the *FFT* window. This will also help the software decide which functions can be performed reliably with the evaluation system.

2.4.4 Configuration Register Panel

In the *Configuration Register* panel, the contents of the Configuration register can be modified by typing a hexadecimal value in the *HEX:* field, or by changing any of the values below the *HEX:* field to the desired settings. Although the CDB5461AU software allows the user to modify any of the bits in the Configuration register, changing certain bits may cause the software and board to behave erratically. For the evaluation system to function properly, the *Interrupt Output* field should be set to the default, *Active Low* setting, and *E1, E2 Function* field should be set to the default *Normal*. This applies only to the CDB5461AU evaluation system, and not to the CS5461A chip itself.

2.4.5 Mask Register/Status Register Panel

The Mask and Status registers are displayed in hexadecimal and decoded in this box to indicate each bit's function. The Mask register can be modified by typing a value in the *HEX:* field, or by checking the appropriate check boxes for the bits that are to be masked. The Status register cannot be directly modified. It can only be reset by pressing the *Clear Status Register* button. The *HEX:* field for this register, and the associated "lamps" are for display only. A lamp that is on means that the corresponding bit in the Status Register is set (except the *Invalid Command* bit, which is inverted). The value present in the Mask register may be changed by the software during certain operations to provide correct functionality of the CDB5461AU board.

2.4.6 Cycle Count / PulseRateE / PulseWidth / VSAGlevel / VSAGduration Registers

These fields display the values of the corresponding register in both hexadecimal and decimal format. Each register can be modified by typing a value in the corresponding *Value:* or *HEX:* field.

2.4.7 Control Register

The Control register contains various bits used to activate or terminate various features of the CS5461A. Refer to the CS5461A data sheet for descriptions of these bits. The user is able to set or clear each bit individually. The value of the Control register is displayed in the *HEX:* field. Most of the Control register bits are reserved or unused. Only the usable bits are displayed in the *Setup* window.

2.5 Calibration Window

The *Calibration* window is used to display and write to the CS5461A Offset and Gain calibration registers. The user is also able to initiate the CS5461A's calibration sequences that are used to set the calibration values. Both AC and DC calibrations can be run for offset and gain, for either the voltage channel or the current channel, or both simultaneously. The user should refer to the CS5461A data sheet for more details on calibration.

The *Refresh Screen* button will update the contents of the window by reading all the register values from the CS5461A device. It is a good idea to press the *Refresh Screen* button when entering the *Calibration* window, or after modifying any registers to reflect the current status of the device.

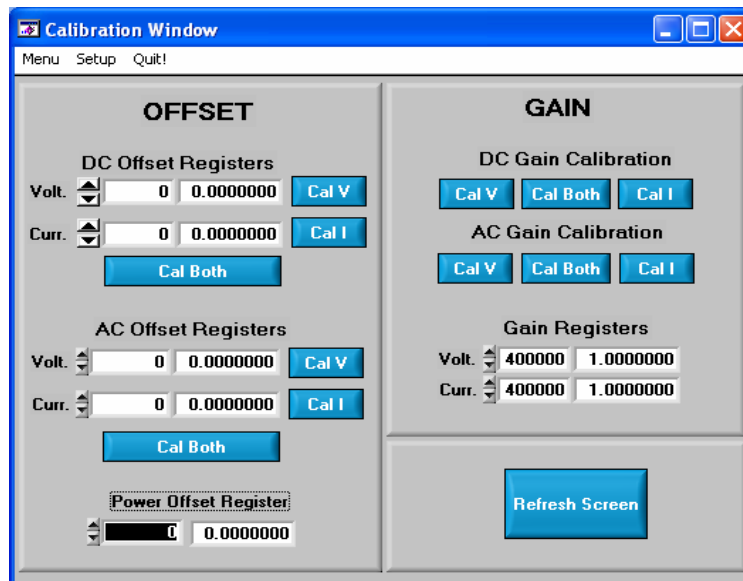

Figure 9. Calibration Window

2.5.1 Offset & Gain Registers

In the *Offset* and *Gain* register panels, the offset and gain registers for both channels are displayed in hexadecimal and decimal. These registers can all be modified directly by typing the desired value in the hexadecimal display fields. There are two types of offset registers: *DC Offset* and *AC Offset*. The AC Offset register only affects the RMS register values. The DC and AC offset register values are two's complement numbers whose values ranges from -1 to +1.

2.5.2 Performing Calibrations

Offset and gain calibrations can be performed on both the voltage and current channels of the CS5461A. It is generally a good idea to software reset the CS5461A before running calibrations because the values in the calibration registers will affect the results of the calibration. A software reset will reset these registers back to the default values of zero offset and unity gain. Offset calibration should be performed before gain calibration to ensure accurate results.

2.5.2.1 *Offset Calibrations*

1. Ground the channel(s) you want to calibrate directly at the channel header(s). J17 and J22 for the voltage channel, and J24 and J26 for the current channel. The channel(s) could also be grounded directly at the screw terminals.
2. Press the corresponding AC or DC offset calibrate button(s) (*Cal V*, *Cal I*, or *Cal Both*) in the *Offset* panel.
3. The calibration value(s) will automatically update when the calibration is completed.

2.5.2.2 *Gain Calibrations*

1. Attach an AC or DC calibration signal to the screw terminals, and make sure the corresponding channel headers (J17, J22, J24, and J26) are set to the *Input* position.
2. Press the corresponding AC or DC gain calibrate button(s) (*Cal V*, *Cal I*, or *Cal Both*) in the *Gain* Panel.
3. The calibration value(s) will automatically update when the calibration is completed.

The *Calibration* window also contains the *Power Offset* register display and adjustment fields. The user can read and write the value in the *Power Offset* register.

2.6 Conversion Window

The *Conversion* window shown in Figure 10 allows the user to see the results of single and continuous conversions, perform data averaging, utilize the power-saving modes of the CS5461A, and reset the CS5461A's serial port. The *Conversion* window can be accessed by pulling down the *Menu* option, and selecting *Conversion Window*, or by pressing <F4>.

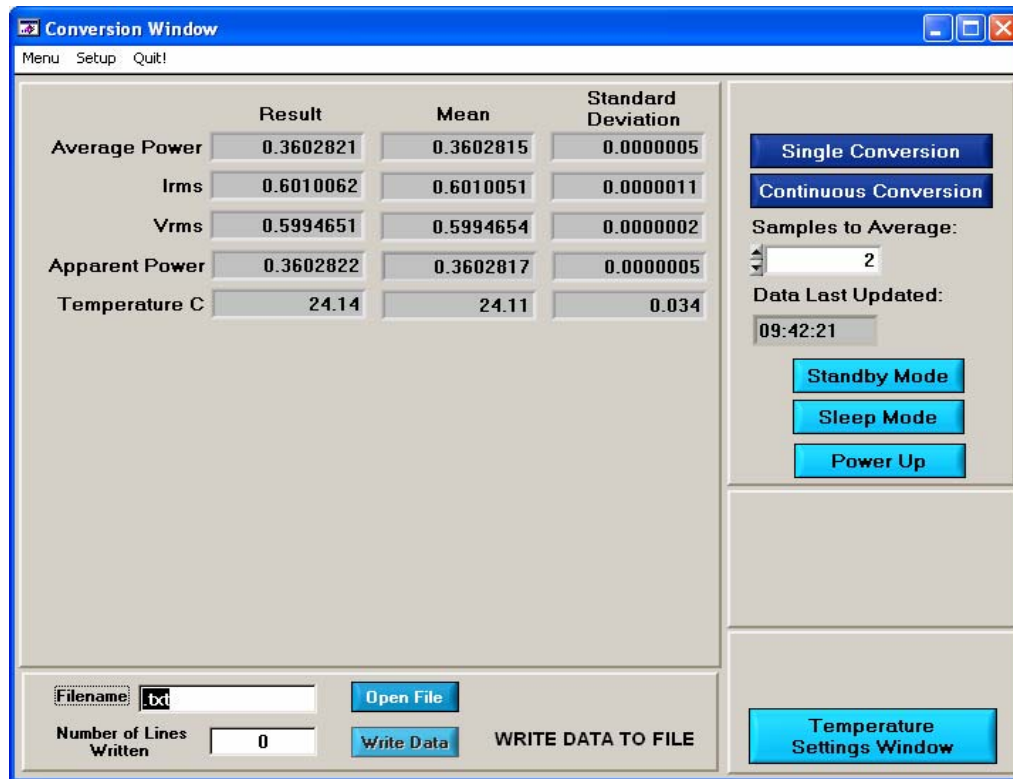

Figure 10. *Conversion* Window

2.6.1 Single Conversion Button

By pressing this button, single conversions will be performed. After a single conversion is complete, the *Result* data column will be updated with the values present in each data register.

2.6.2 Continuous Conversion Button

By pressing this button, continuous conversions will be performed until the user presses the *Stop* button. After each conversion is complete, the *Result* data column will be updated with the values present in each data register. The *Mean* and *Standard Deviation* columns will be updated every N cycles, where N is the number in the *Samples to Average*: box. It may take many collection cycles after pressing the *Stop* button before the data actually stops being collected.

2.6.3 Standby & Sleep Mode Buttons

When these buttons are pressed, the CS5461A device will enter either Standby or Sleep power-saving mode. To return to normal mode, press the *Power Up* button.

2.6.4 Power Up Button

This button is used to send the Power-up/Halt command to the CS5461A. The device will return to normal operating mode and halt any conversions that are being performed at the time.

2.6.5 Temperature Settings Window

The *Temperature Settings* window is used to adjust the CS5461A's Temperature Offset register (T_{offset}) and Temperature Gain register (T_{gain}) to convert the Temperature Register (T) from a Celsius scale ($^{\circ}C$) to a Fahrenheit scale ($^{\circ}F$) and to improve temperature measurement accuracy. Refer to the CS5461A data sheet for the details of the On-chip Temperature Sensor.

2.6.6 Write Data to File Window

This window provides a means to write the conversion result data to a *.txt* file for later analysis or print out. The file path and name will be shown in *Filename* field. The *Open File* button is used to open a new or existing *.txt* file for writing data. Each time the *Write Data* button is pressed, the result data is written to the file and the *Number of Lines Written* field will be incremented by 1.

2.7 Pulse Rate Window

The CS5461A features a pulse-rate energy output. The CDB5461AU has the capability to demonstrate the functionality of this output in the *Pulse Rate Output* window shown in Figure 11. The *Pulse Rate Output* window can be accessed by pressing <F5>, or by pulling down *Menu*, and selecting *Pulse Rate Window*.

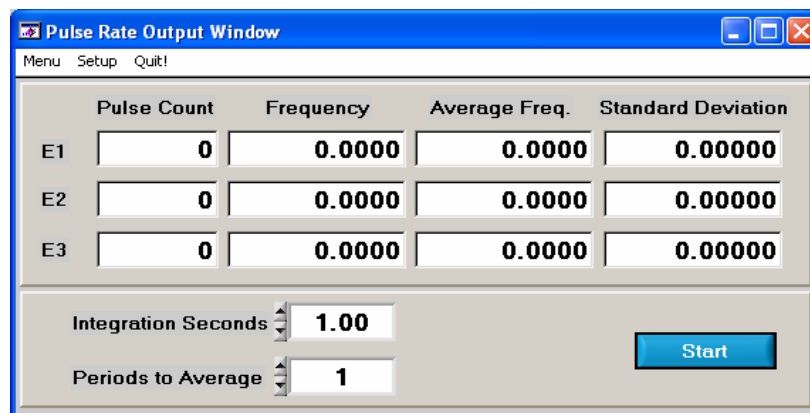

Figure 11. Pulse Rate Output Window

2.7.1 Integration Seconds Field

This box allows the user to select the length of time over which pulses will be collected.

2.7.2 Periods to Average Field

This box allows the user to average a number of integration periods.

2.7.3 Start Button

When the *Start* button is pressed, the CDB5461AU will capture pulse rate data according to the values in the *Integration Seconds* and *Periods to Average* fields. After each integration period, the *Pulse Count* and *Frequency* columns will be updated. The *Average Freq.* and *Standard Deviation* columns will only be updated after all the integrations have been collected. The software stops collecting data when the user presses the *Stop* button, or when the data collection is complete. Due to speed limitations of the on-board microcontroller, some higher pulse rates cannot be accurately collected.

2.8 Data Collection Window

The *Data Collection* window (Figure 12, Figure 13, and Figure 14) allows the user to collect sample sets of data from the CS5461A and analyze them using time domain, FFT, and histogram plots. The *Data Collection* window is accessible through the *Menu* pull-down, or by pressing <F6>.

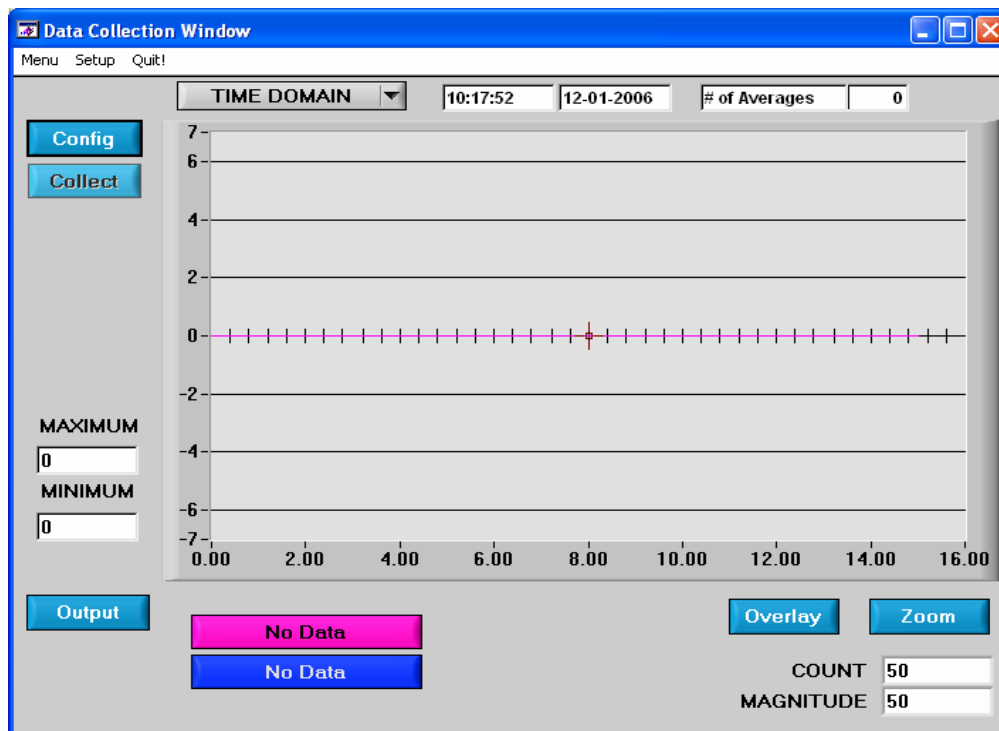

Figure 12. Data Collection Window

2.8.1 Time Domain / FFT / Histogram Pull-down

This pull-down selects the type of data processing to perform on the collected data and display in the plot area. Refer to the section on *Analyzing Data* for more information.

2.8.2 Config Button

This button will bring up the *Configuration* window, in which the user can modify the data collection specifications. See the discussion of the *Config* window in this document.

2.8.3 **Collect Button**

This button will collect data from the CS5461A device to be analyzed in the plot area. See the section on *Collecting Data Sets* for more information.

2.8.4 **Output Button**

This button will bring up a window in which the user can output the data to a file for later use, print out a plot, or print out the entire screen. When saving data, only the data channel being displayed on the plot will be saved to a file.

2.8.5 **Zoom Button**

This button allows the user to zoom in on the plot by selecting two points in the plot area. Press the *Restore* button to return to the normal data plot, or press the *Zoom* button again to zoom in even further.

2.8.6 **Channel Select Button**

After data collection, *Current* and *Voltage* channel select buttons will appear below the graph, allowing the user to choose the appropriate channel for display. In the *Time Domain* mode, an additional *Overlay* button will be present, to allow the user to display all the channels on the same plot.

2.8.7 **Config Window**

The *Config* window allows the user to set up the data collection and analysis parameters.

2.8.7.1 *Number of Samples*

This field allows the user to select the number of samples to collect – between 16 and 32768.

2.8.7.2 *Average*

When doing FFT processing, this field will determine the number of FFTs to average. FFTs will be collected and averaged when the *Collect* button is pressed.

2.8.7.3 *FFT Window*

This field allows the user to select the type of windowing algorithm for FFT processing. Windowing algorithms include the *Blackman*, *Blackman-Harris*, *Hanning*, *5-term Hodia*, and *7-term Hodia*. The *5-term Hodia* and *7-term Hodia* are windowing algorithms developed at Crystal Semiconductor.

2.8.7.4 *Histogram Bin Width*

This field allows for a variable bin width when plotting histograms of the collected data. Each vertical bar in the histogram plot will contain the number of output codes contained in this field. Increasing this number allows the user to view histograms with larger input ranges.

2.8.7.5 *Data to Collect*

These 3 check boxes allow the user to select the data types that will be collected and returned to the PC for processing.

2.8.7.6 Cycle Count

The value in *Cycle Count* field will be written to the CS5461A's Cycle Count register. *Cycle Count* determines the length of one computation cycle. *Cycle Count* should be selected appropriately according to the *Data to Collect* selection. For example, if the *Data to Collect* is instantaneous Current, Voltage, or Power, it is better to set *Cycle Count* to 1. If the data to collect is RMS Current, RMS Voltage, or Average Power, *Cycle Count* should be set to a value that makes one computation cycle to be an even multiple of the line frequency.

2.8.7.7 Accept Button

When this button is pressed, the current settings will be saved, and the user will return to the *Data Collection* window.

2.8.8 Collecting Data Sets

To collect a sample data set:

1. In the Data Collection Window, press the Config button to bring up the Configuration Window and view the current settings.
2. Select the appropriate settings from the available options (see the section on the Configuration Window) and press the Accept button.
3. The Data Collection Window should still be visible. Press the Collect button to begin collecting data.
4. Once the data has been collected, it can be analyzed, printed, or saved to disk.

2.8.9 Retrieving Saved Data from a File

The CDB5461AU software allows the user to save data to a file, and retrieve it later when needed. To load a previously saved file:

1. Pull down the Setup option and select Disk. A file menu will appear.
2. Find the data file in the list and select it. Press the select button to return.
3. Go to the Data Collection Window, and press the Collect button.
4. The data from the file should appear on the screen. To select a different file, repeat the procedure.

2.8.10 Analyzing Data

The evaluation software provides three types of analysis tests: *Time Domain*, *Frequency Domain*, and *Histogram*. The *Time Domain* analysis process acquires conversions to produce a plot of magnitude versus conversion sample number. The *Frequency Domain* analysis process acquires conversions to produce a plot of magnitude versus frequency using the Fast-Fourier Transform (results up to $F_s/2$ are calculated and plotted). Also statistical noise calculations are calculated and displayed. The *Histogram* analysis test process acquires conversions to produce a histogram plot. Statistical noise calculations are also calculated and displayed.

2.8.11 Histogram Information

The following is a description of the indicators associated with *Histogram* analysis. Histograms can be plotted in the Data Collection window by setting the *Time Domain / FFT / Histogram* selector to *Histogram* (Figure 13).

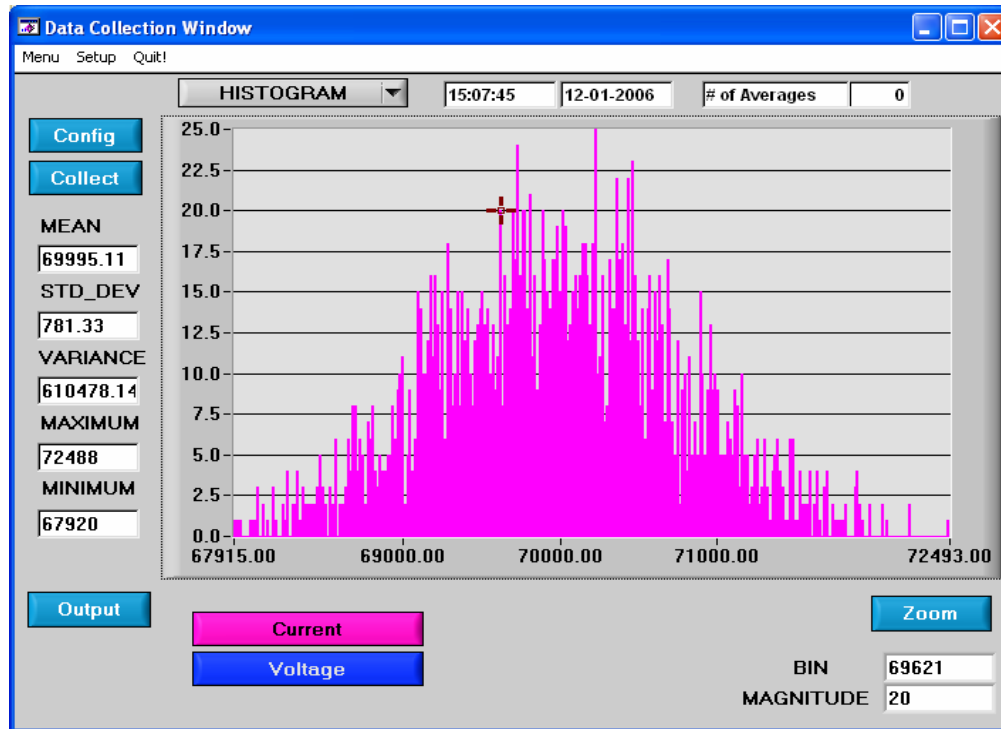

Figure 13. Histogram Analysis

2.8.11.1 Bin

Displays the x-axis value of the cursor on the Histogram.

2.8.11.2 Magnitude

Displays the y-axis value of the cursor on the Histogram.

2.8.11.3 Mean

Indicator for the mean of the data sample set. The mean is calculated using the following formula:

$$Mean = \frac{\sum_{i=0}^{n-1} Xi}{n}$$

2.8.11.4 *STD_DEV*

Indicator for the standard deviation of the collected data set. The standard deviation is calculated using the following formula:

$$StdDev = \sqrt{\frac{\sum_{i=0}^{n-1} (Xi - Mean)^2}{n}}$$

2.8.11.5 *Variance*

Indicator for the variance of the current data set. The variance is calculated using the following formula:

$$Var = \frac{\sum_{i=0}^{n-1} (Xi - Mean)^2}{n}$$

2.8.11.6 *Maximum*

Indicator for the maximum value of the collected data set.

2.8.11.7 *Minimum*

Indicator for the minimum value of the collected data set.

2.8.12 Frequency Domain Information

The following describe the indicators associated with *FFT* (Fast Fourier Transform) analysis. *FFT* data can be plotted in the *Data Collection* window by setting the *Time Domain / FFT / Histogram* selector to *FFT* (Figure 14).

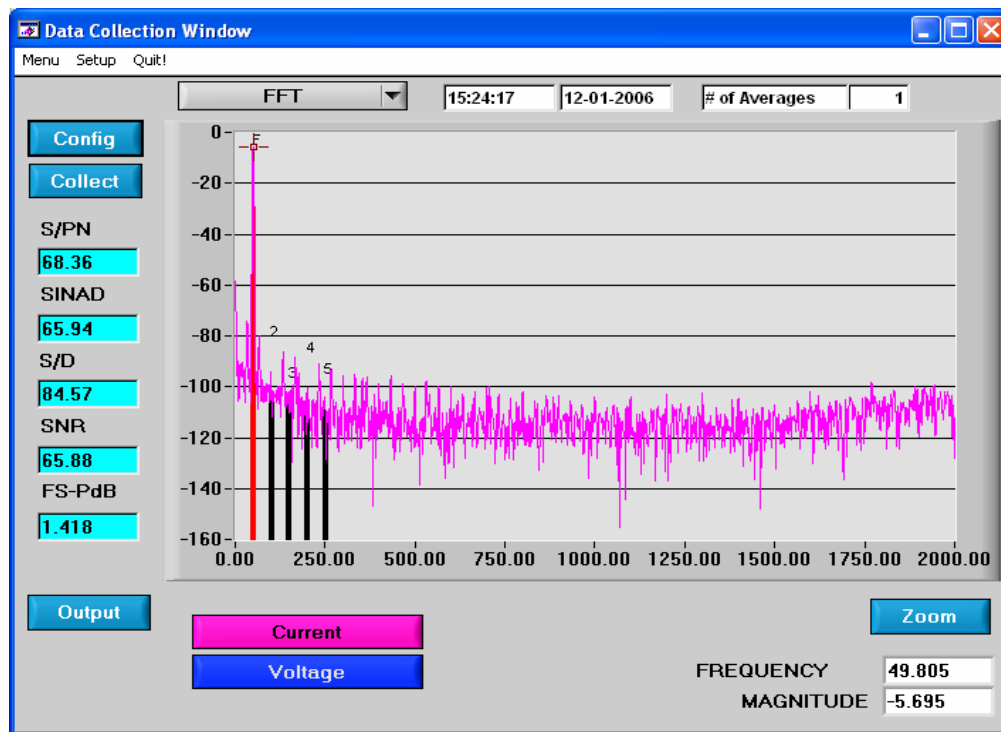

Figure 14. FFT Analysis

2.8.12.1 Frequency

Displays the x-axis value of the cursor on the FFT display.

2.8.12.2 Magnitude

Displays the y-axis value of the cursor on the FFT display.

2.8.12.3 S/PN

Indicator for the signal-to-peak noise ratio (decibels).

2.8.12.4 SINAD

Indicator for the signal-plus-noise-plus-distortion to noise-plus-distortion ratio (decibels).

2.8.12.5 S/D

Indicator for the signal-to-distortion ratio, 4 harmonics are used in the calculations (decibels).

2.8.12.6 SNR

Indicator for the signal-to-noise ratio, first 4 harmonics are not included (decibels).

2.8.12.7 Fs-Pdb

Indicator for the full-scale to signal ratio (decibels).

2.8.13 Time Domain Information

The following controls and indicators are associated with *Time Domain* analysis. *Time Domain* data can be plotted in the *Data Collection* window by setting the *Time Domain / FFT / Histogram* selector to *Time Domain* (Figure 15).

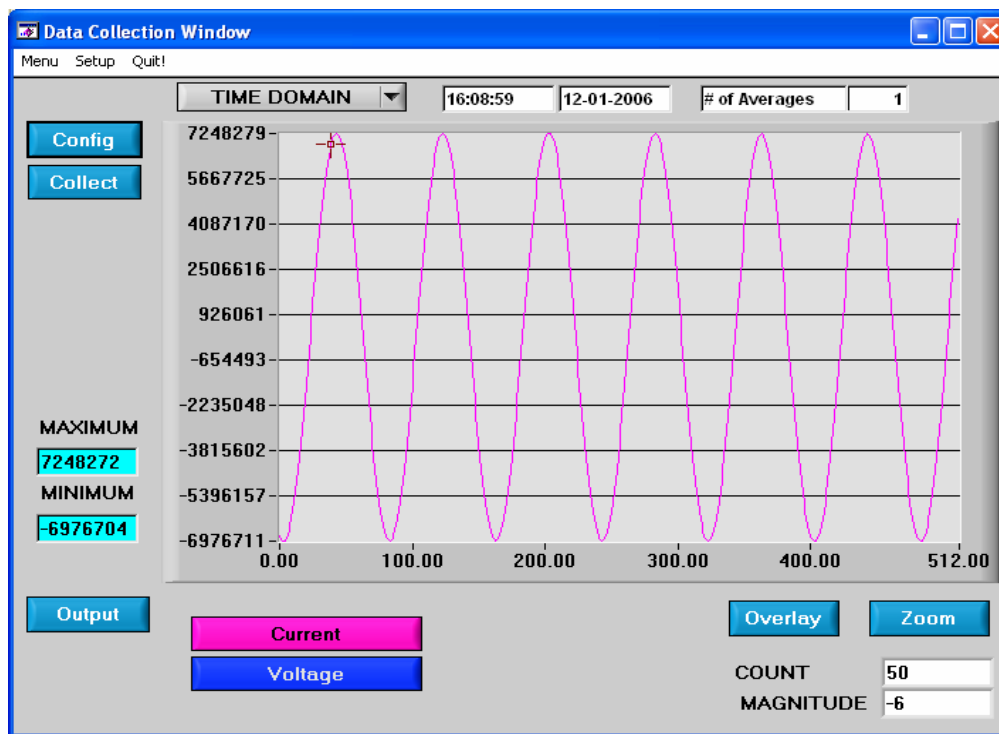

Figure 15. Time Domain Analysis

2.8.13.1 Count

Displays current x-position of the cursor on the time domain display.

2.8.13.2 Magnitude

Displays current y-position of the cursor on the time domain display.

2.8.13.3 Maximum

Indicator for the maximum value of the collected data set.

2.8.13.4 *Minimum*

Indicator for the minimum value of the collected data set.

2.9 EEPROM Window

CDB5461AU has an “Auto-boot” Demo feature for the serial EEPROM, which means CDB5461AU can operate independently without connecting to a PC. The CDB5461AU GUI software also provides an EEPROM window for reading/writing the serial EEPROM (Figure 16).

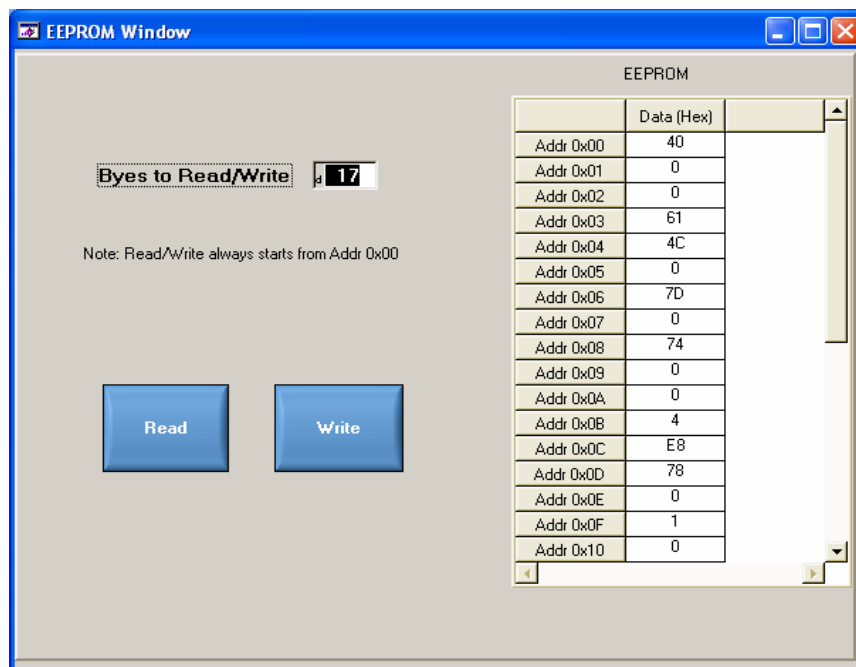

Figure 16. *EEPROM Window*

The *Bytes to Read/Write* field allows the user to define the number of bytes to be read or written.

2.9.1 Read EEPROM

After pressing the *Read* button, the number of bytes indicated in the *Bytes to Read/Write* field, starting from address 0x00 will be read from EEPROM and displayed in the *EEPROM* table in Hexadecimal format.

2.9.2 Write EEPROM

Starting from address 0x00, enter into the *EEPROM* table the bytes to be written. Pressing the *Write* button, the bytes in the *EEPROM* table will be written to the EEPROM.

2.9.3 Debug Window

The *Debug* window provides the user a way to access the CS5461A registers and send commands to the device directly (Figure 17). Refer to the CS5461A data sheet for more details.

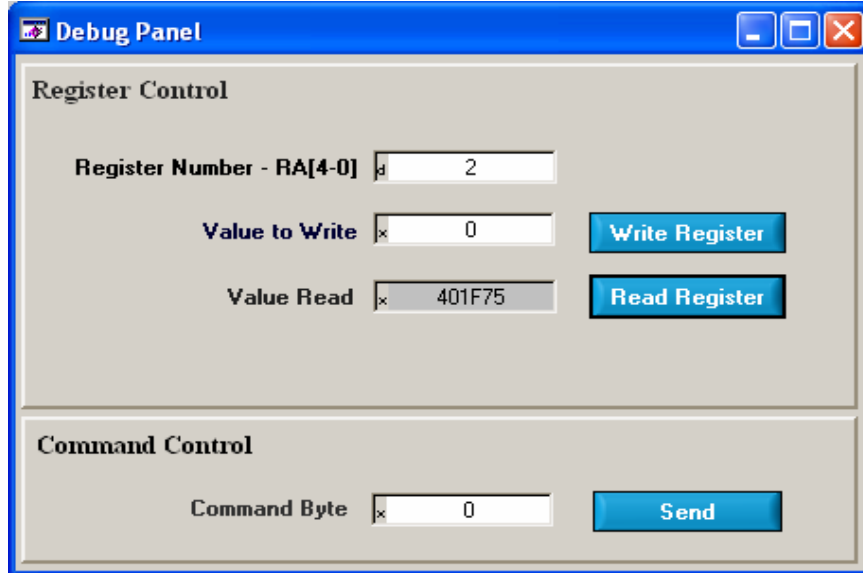

Figure 17. *Debug Window*

3. SCHEMATICS

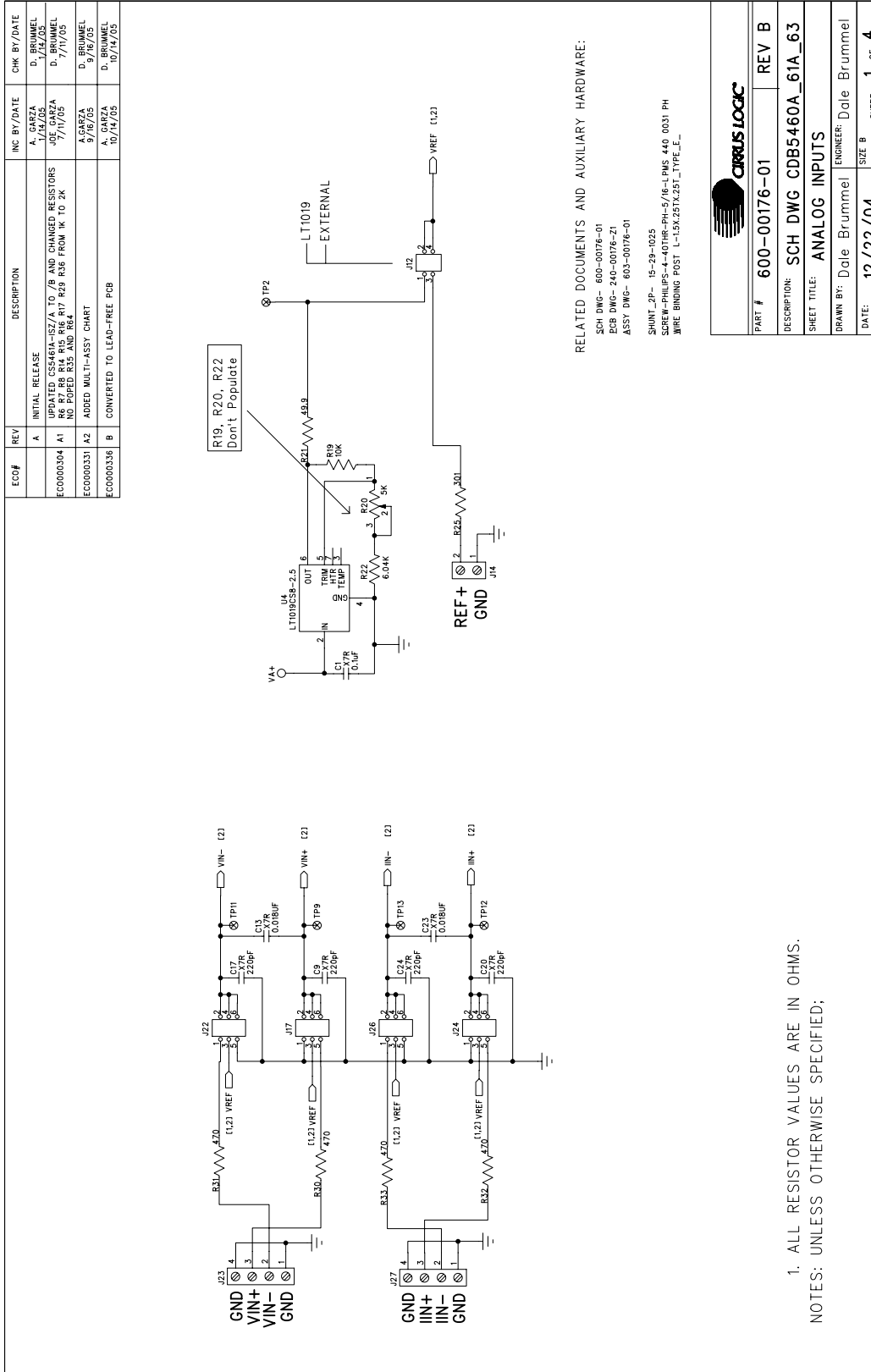

Figure 18. Analog Inputs

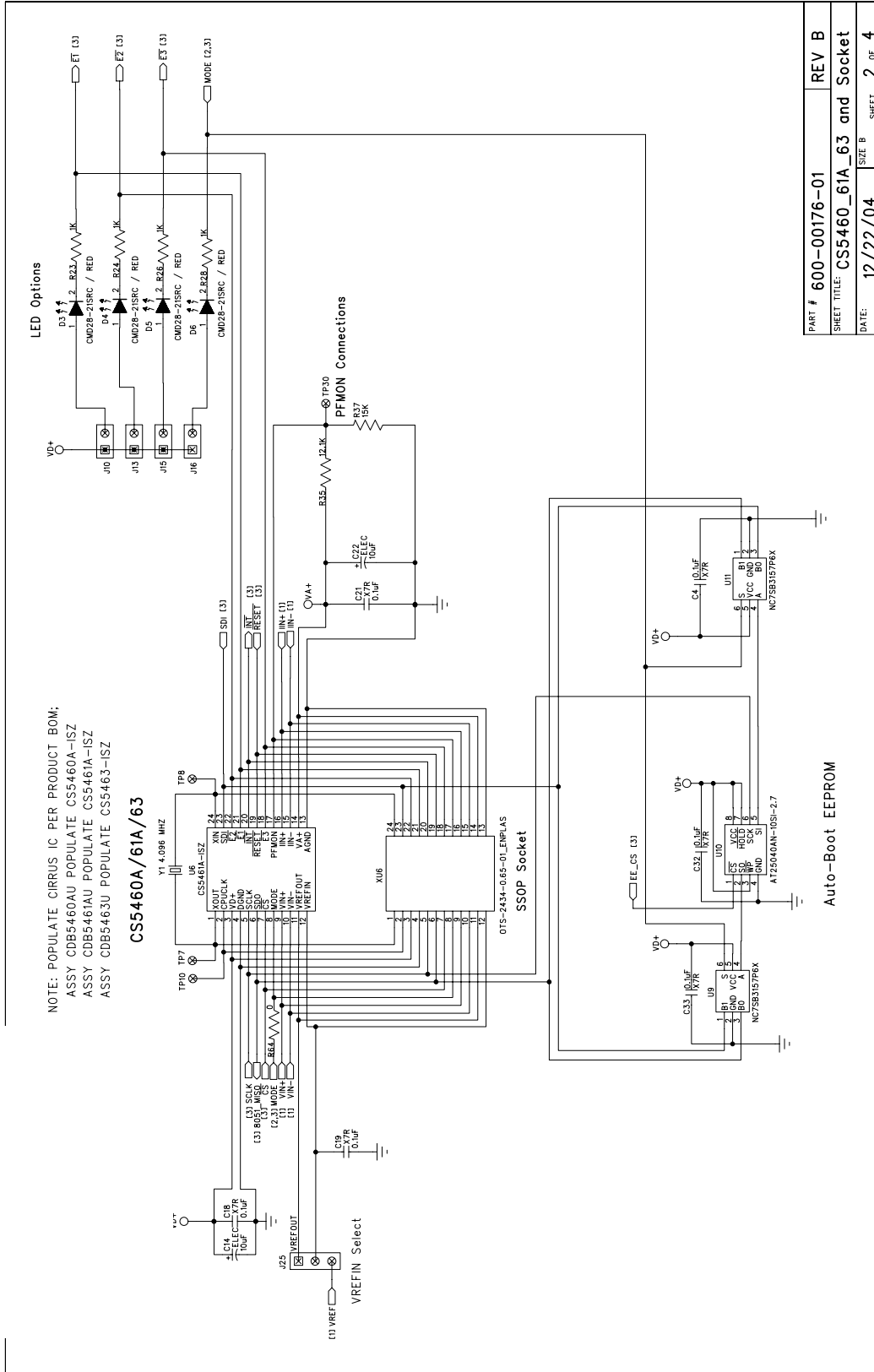
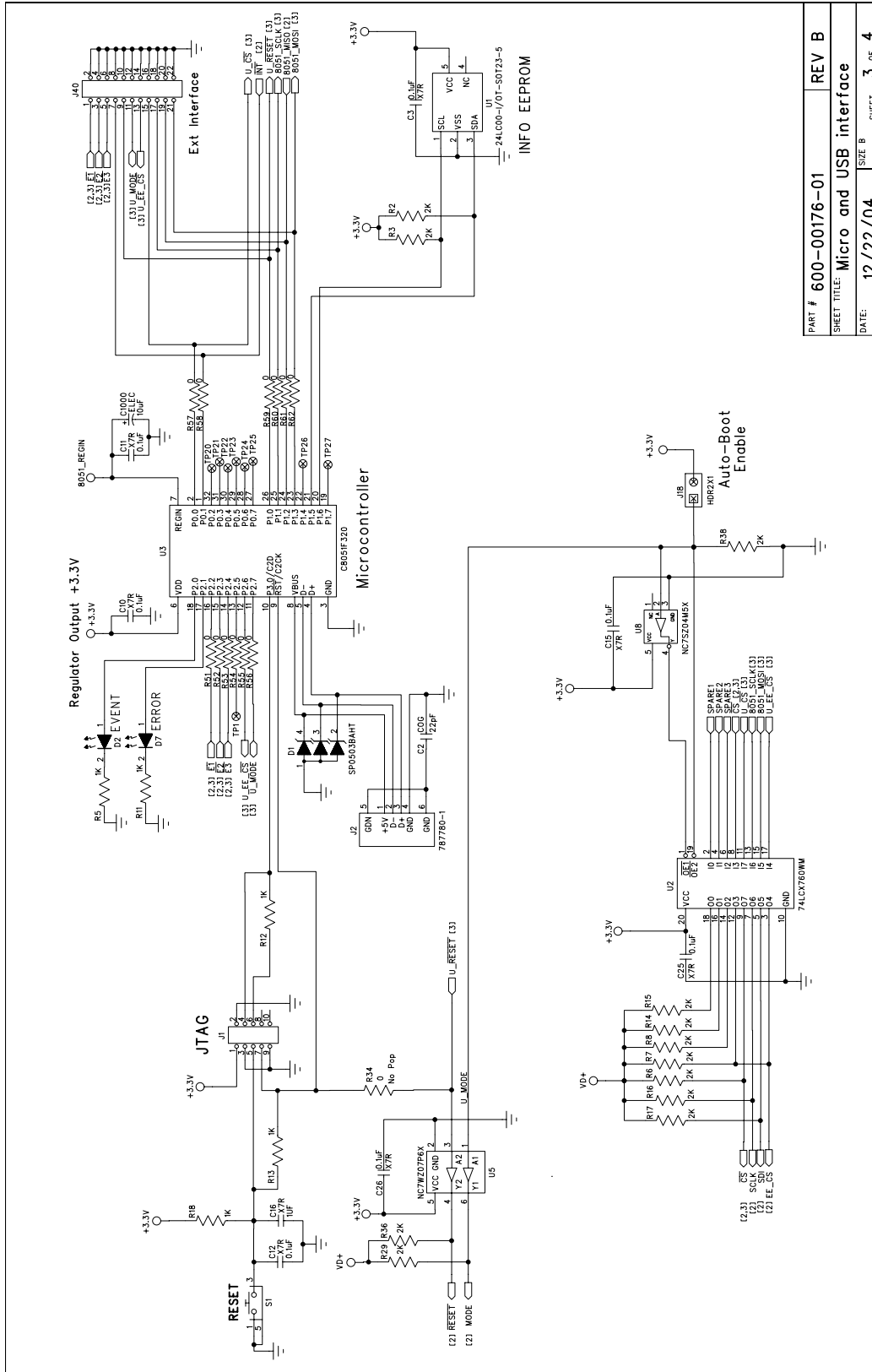
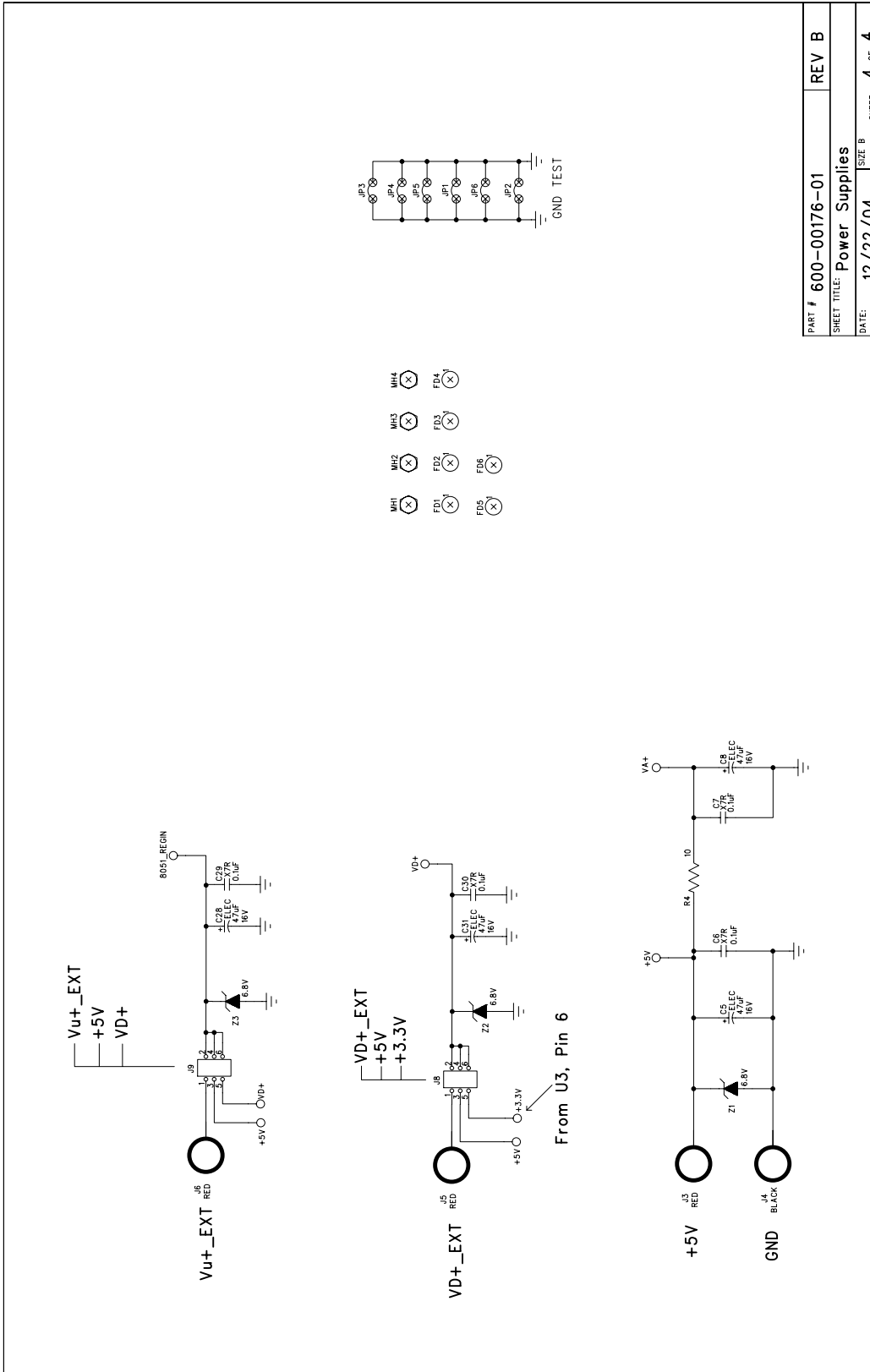

Figure 19. CS546x and Socket



PART #	600-00176-01	REV B
SHEET TITLE:	Micro and USB interface	
DATE:	12/22/04	SIZE B SHEET 3 OF 4

Figure 20. Microcontroller and USB Interface

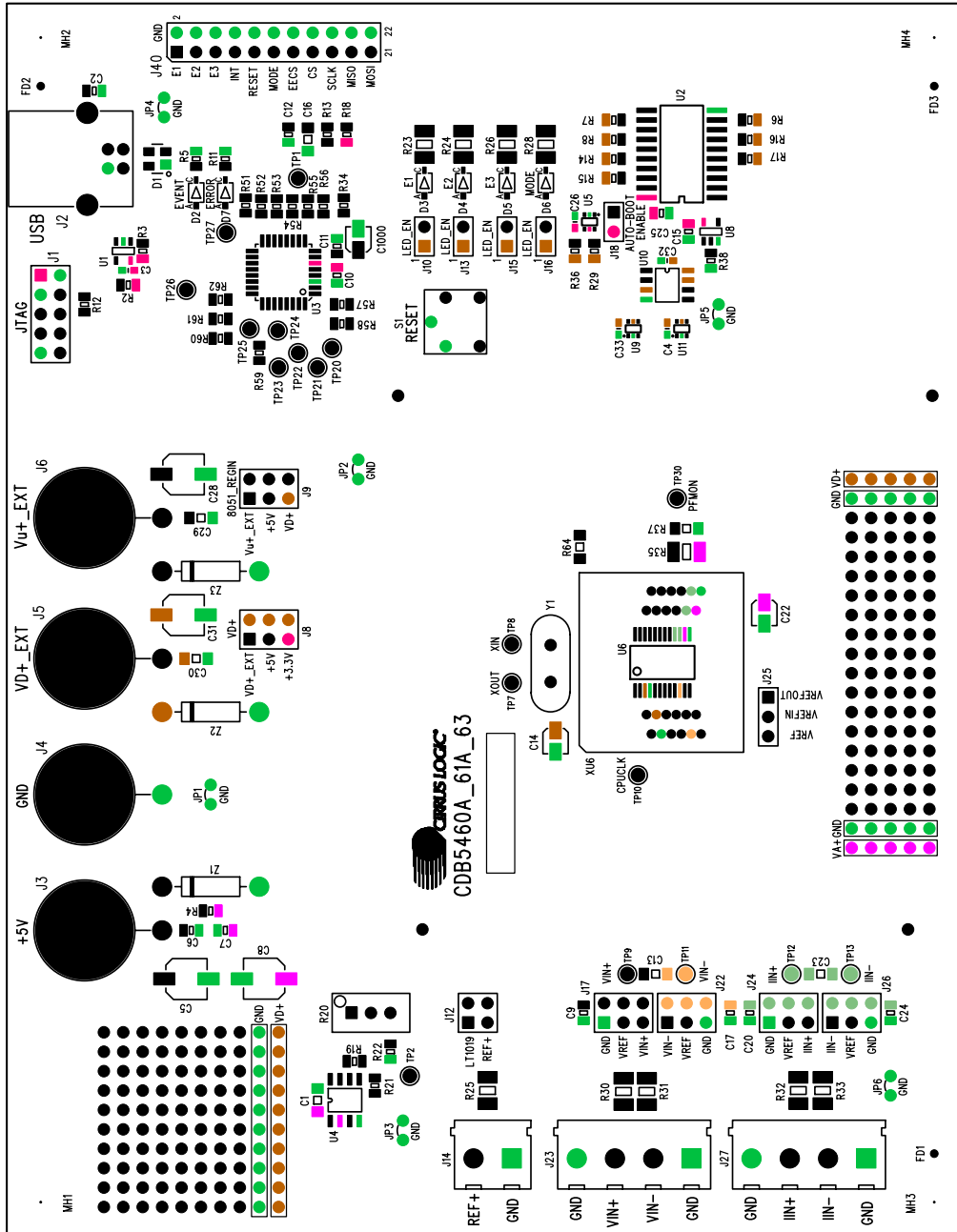
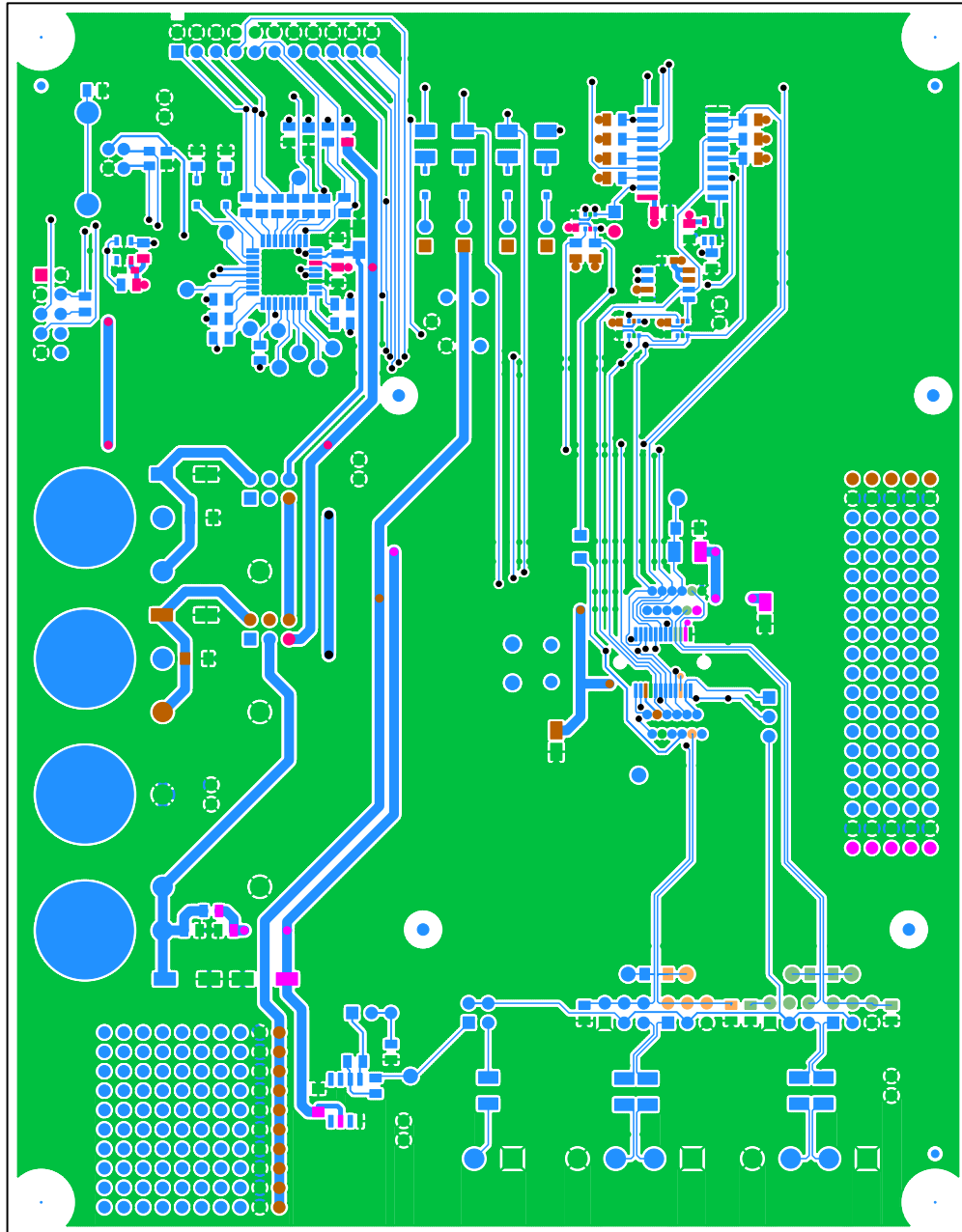

Figure 21. Power Supplies

4. LAYOUT



CIRRUS LOGIC PCB-240-00176-Z1 Rev B
SILKSCREEN TOP

Figure 22. Top Silk Screen



TOP SIDE

Figure 23. Topside Layer

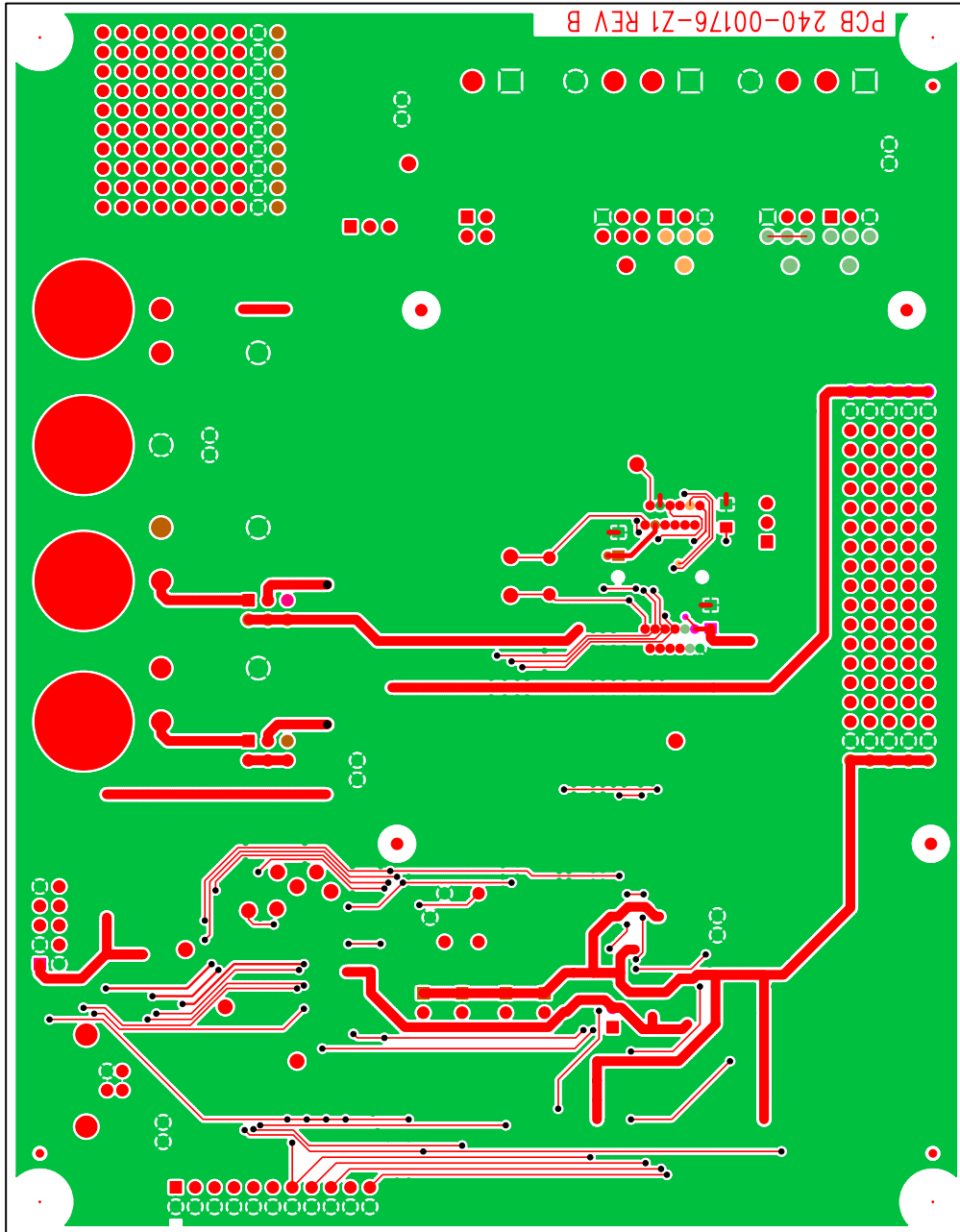

BOTTOM SIDE

Figure 24. Bottomside Layer

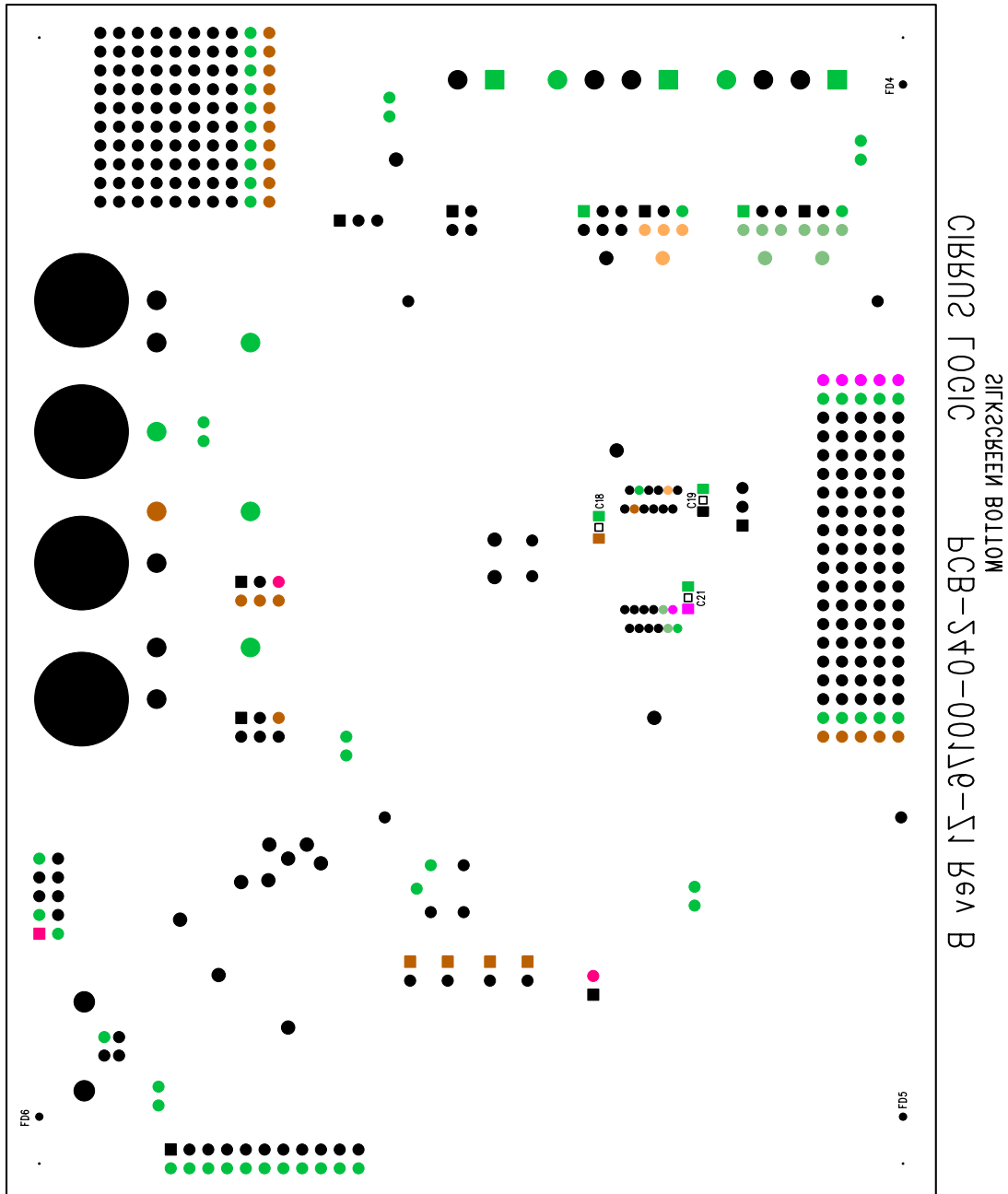

Figure 25. Bottom Silk Screen

Contacting Cirrus Logic Support

For all product questions and inquiries contact a Cirrus Logic Sales Representative.
To find one nearest you go to www.cirrus.com

IMPORTANT NOTICE

Cirrus Logic, Inc. and its subsidiaries ("Cirrus") believe that the information contained in this document is accurate and reliable. However, the information is subject to change without notice and is provided "AS IS" without warranty of any kind (express or implied). Customers are advised to obtain the latest version of relevant information to verify, before placing orders, that information being relied on is current and complete. All products are sold subject to the terms and conditions of sale supplied at the time of order acknowledgment, including those pertaining to warranty, indemnification, and limitation of liability. No responsibility is assumed by Cirrus for the use of this information, including use of this information as the basis for manufacture or sale of any items, or for infringement of patents or other rights of third parties. This document is the property of Cirrus and by furnishing this information, Cirrus grants no license, express or implied under any patents, mask work rights, copyrights, trademarks, trade secrets or other intellectual property rights. Cirrus owns the copyrights associated with the information contained herein and gives consent for copies to be made of the information only for use within your organization with respect to Cirrus integrated circuits or other products of Cirrus. This consent does not extend to other copying such as copying for general distribution, advertising or promotional purposes, or for creating any work for resale.

CERTAIN APPLICATIONS USING SEMICONDUCTOR PRODUCTS MAY INVOLVE POTENTIAL RISKS OF DEATH, PERSONAL INJURY, OR SEVERE PROPERTY OR ENVIRONMENTAL DAMAGE ("CRITICAL APPLICATIONS"). CIRRUS PRODUCTS ARE NOT DESIGNED, AUTHORIZED OR WARRANTED FOR USE IN AIRCRAFT SYSTEMS, MILITARY APPLICATIONS, PRODUCTS SURGICALLY IMPLANTED INTO THE BODY, AUTOMOTIVE SAFETY OR SECURITY DEVICES, LIFE SUPPORT PRODUCTS OR OTHER CRITICAL APPLICATIONS. INCLUSION OF CIRRUS PRODUCTS IN SUCH APPLICATIONS IS UNDERSTOOD TO BE FULLY AT THE CUSTOMER'S RISK AND CIRRUS DISCLAIMS AND MAKES NO WARRANTY, EXPRESS, STATUTORY OR IMPLIED, INCLUDING THE IMPLIED WARRANTIES OF MERCHANTABILITY AND FITNESS FOR PARTICULAR PURPOSE, WITH REGARD TO ANY CIRRUS PRODUCT THAT IS USED IN SUCH A MANNER. IF THE CUSTOMER OR CUSTOMER'S CUSTOMER USES OR PERMITS THE USE OF CIRRUS PRODUCTS IN CRITICAL APPLICATIONS, CUSTOMER AGREES, BY SUCH USE, TO FULLY INDEMNIFY CIRRUS, ITS OFFICERS, DIRECTORS, EMPLOYEES, DISTRIBUTORS AND OTHER AGENTS FROM ANY AND ALL LIABILITY, INCLUDING ATTORNEYS' FEES AND COSTS, THAT MAY RESULT FROM OR ARISE IN CONNECTION WITH THESE USES.

Cirrus Logic, Cirrus, and the Cirrus Logic logo designs are trademarks of Cirrus Logic, Inc. All other brand and product names in this document may be trademarks or service marks of their respective owners.

Windows, Windows 2000, and Windows XP are registered trademarks of Microsoft Corporation.

SPI is a trademark of Motorola, Inc.

CVI is a trademark of National Instruments Corporation.