

CAR600M17HN6

1700 V, 600 A, Silicon Carbide, Half-Bridge Rectifier

V_R	1700 V
I_F	600 A

Technical Features

- Ultra-Low Loss, High Frequency Operation
- Low Forward Voltage (V_f) Drop with Positive Temperature Coefficient
- Zero Reverse Recovery Current
- Zero Forward Recovery Voltage
- Temperature-Independent Switching Behavior

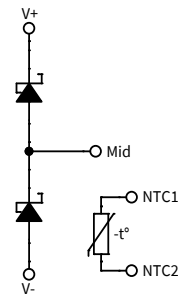
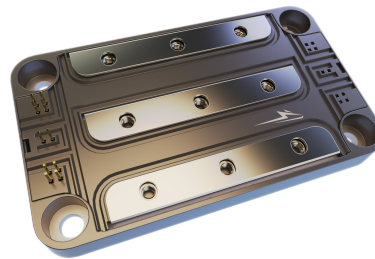

Applications

- Railway, Traction, and Motor Drives
- EV Chargers
- High-Efficiency Converters / Inverters
- Renewable Energy
- Smart-Grid / Grid-Tied Distributed Generation

System Benefits

- Enables Compact, Lightweight Systems
- Increased System Efficiency, due to Low Switching & Conduction Losses of SiC
- Reduced Thermal Requirements and System Cost

Maximum Parameters (Verified by Design)

Parameter	Symbol	Min.	Typ.	Max.	Unit	Test Conditions	Note
Maximum Reverse Voltage	V_{R-Max}			1700	V		
Continuous Forward Current	I_F		986		A	$T_C = 25^\circ\text{C}, T_{VJ} \leq 175^\circ\text{C}$	
			702			$T_C = 90^\circ\text{C}, T_{VJ} \leq 175^\circ\text{C}$	
Maximum Pulsed Forward Current	$I_{F(Pulsed)}$			1200		t_{Pmax} limited by T_{VJmax} $T_C = 25^\circ\text{C}$	
Maximum Virtual Junction Temperature	T_{VJ}	-40		175	$^\circ\text{C}$		



Diode Characteristics (Per Position) ($T_{VJ} = 25^{\circ}\text{C}$ unless otherwise specified)

Parameter	Symbol	Min.	Typ.	Max.	Unit	Test Conditions	Note
Diode Forward Voltage	V_F		1.6		V	$I_F = 600 \text{ A}$	
			2.2			$I_F = 600 \text{ A}, T_{VJ} = 175^{\circ}\text{C}$	
Reverse Current	I_R		0.06		mA	$V_R = 1700 \text{ V}, T_{VJ} = 25^{\circ}\text{C}$	
			0.29			$V_R = 1700 \text{ V}, T_{VJ} = 175^{\circ}\text{C}$	
Total Capacitive Charge	Q_C		4.9		mC	$V_R = 1100 \text{ V}$	
Total Capacitance	C		55.7		nF	$V_R = 0 \text{ V}, f = 100 \text{ kHz}$	
			2.9			$V_R = 550 \text{ V}, f = 100 \text{ kHz}$	
			2.7			$V_R = 1100 \text{ V}, f = 100 \text{ kHz}$	
Thermal Resistance, Junction to Case	R_{TH-JC}		0.048			Per position	

Note:

¹SiC Schottky diodes are majority carrier devices, so there is no reverse recovery charge.



Module Physical Characteristics

Parameter	Symbol	Min.	Typ.	Max.	Unit	Test Conditions
Package Resistance, M1 (High-Side)	R_{1-2}		106.5		$\mu\Omega$	$T_c = 125^\circ\text{C}$, Note 1
Package Resistance, M2 (Low-Side)	R_{2-3}		126.3			$T_c = 125^\circ\text{C}$, Note 1
Stray Inductance	L_{Stray}		4.9		nH	Between DC- and DC+, $f = 10 \text{ MHz}$
Case Temperature	T_c	-40		125	$^\circ\text{C}$	
Mounting Torque	M_s	3	4.5	5	N-m	Baseplate, M6 bolts
		0.9	1.1	1.3		Power Terminals, M4 bolts
Weight	W		167		g	
Case Isolation Voltage	V_{isol}	4			kV	AC, 50 Hz, 1 minute
Comparative Tracking Index	CTI	600				
Clearance Distance		13.07			mm	Terminal to Terminal
		6.00				Terminal to Heatsink
Creepage Distance		14.27				Terminal to Terminal
		12.34				Terminal to Heatsink

NTC Characteristics ($T_{\text{NTC}} = 25^\circ\text{C}$ unless otherwise specified)

Parameter	Symbol	Min.	Typ.	Max.	Unit	Notes
Resistance at 25°C	R_{25}		4700		Ω	
Tolerance of R_{25}			± 1		%	
Beta Value for 25°C to 85°C	$B_{25/85}$		3435		K	
Beta Value for 0°C to 100°C	$B_{0/100}$		3399		K	
Tolerance of $B_{25/85}$			± 1		%	
Maximum Power Dissipation	P_{Max}		50		mW	

Steinhart & Hart Coefficients for NTC Resistance & NTC Temperature Computation (T in K)

$$\ln\left(\frac{R}{R_{25}}\right) = A + \frac{B}{T} + \frac{C}{T^2} + \frac{D}{T^3}$$

$$\frac{1}{T} = A_1 + B_1 \ln\left(\frac{R}{R_{25}}\right) + C_1 \ln^2\left(\frac{R}{R_{25}}\right) + D_1 \ln^3\left(\frac{R}{R_{25}}\right)$$

A	B	C	D
-1.289E+01	4.245E+03	-8.749E+04	-9.588E+06

A_1	B_1	C_1	D_1
3.354E-03	3.001E-04	5.085E-06	2.188E-07



Typical Performance

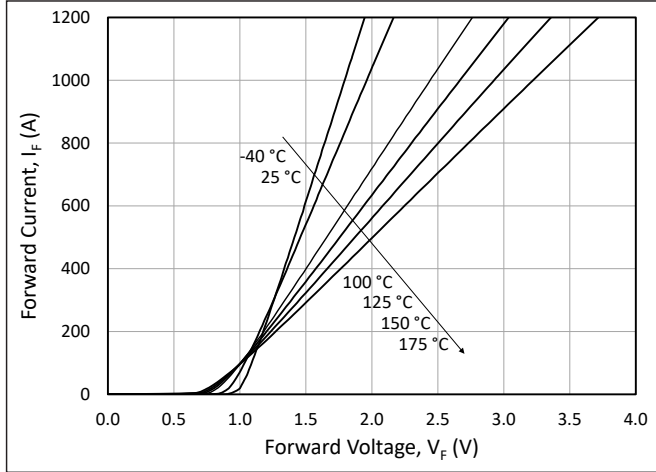

Figure 1. Typical Forward Characteristics

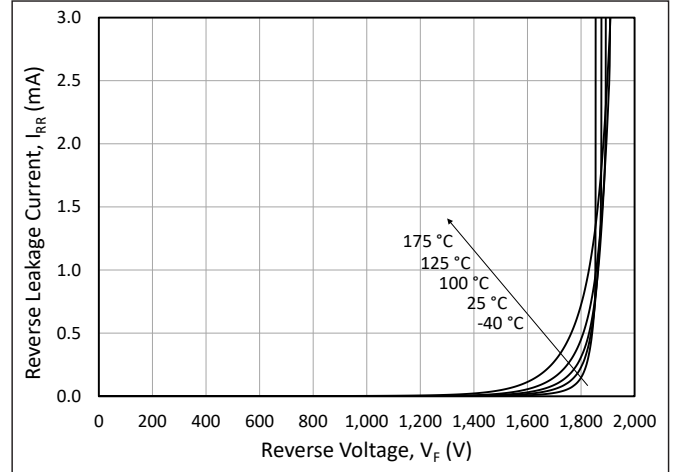

Figure 2. Typical Reverse Characteristics

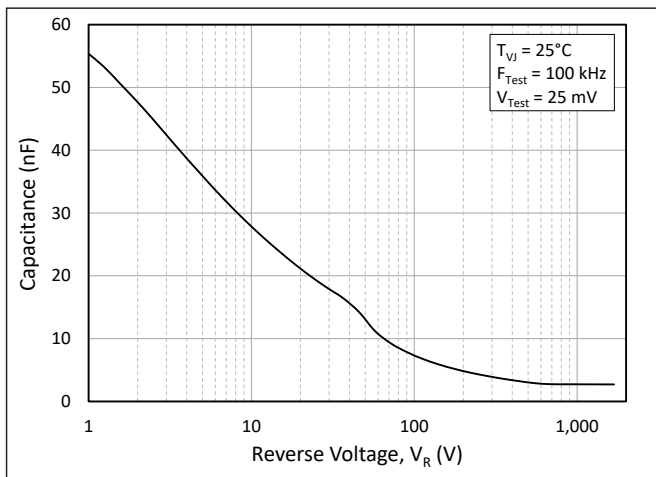

Figure 3. Typical Capacitance vs. Reverse Voltage

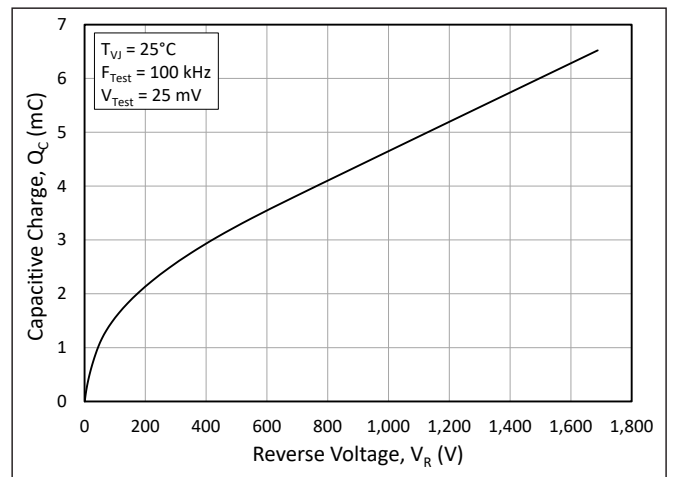

Figure 4. Typical Capacitive Charge vs. Reverse Voltage

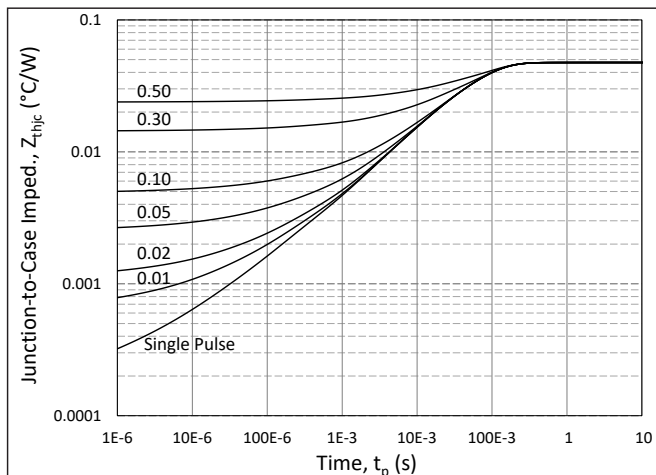

Figure 5. Diode Junction to Case Transient Thermal Impedance, Z_{thJC} (°C/W)

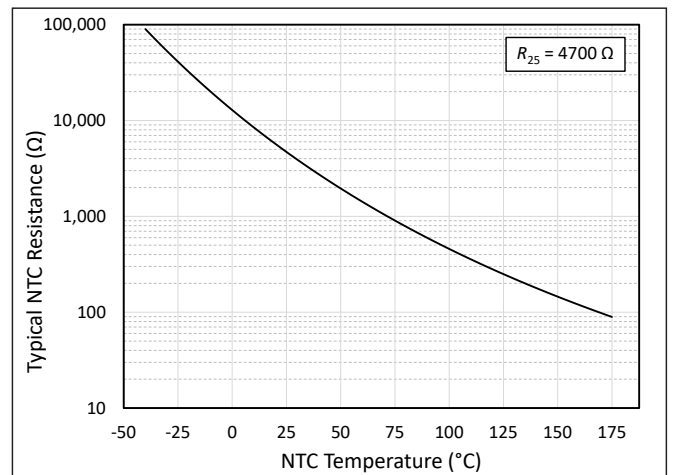
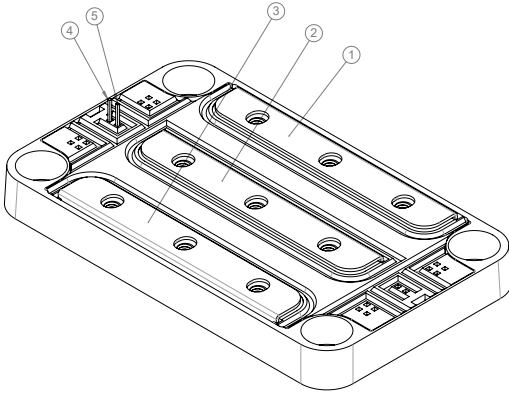

Figure 6. NTC Resistance vs. NTC Temperature



Schematic and Pin Out



PIN OUT SCHEME	
PIN	LABEL
①	V+
②	Mid
③	V-
④	NTC1
⑤	NTC2

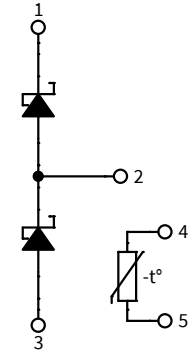

Package Dimension (mm)

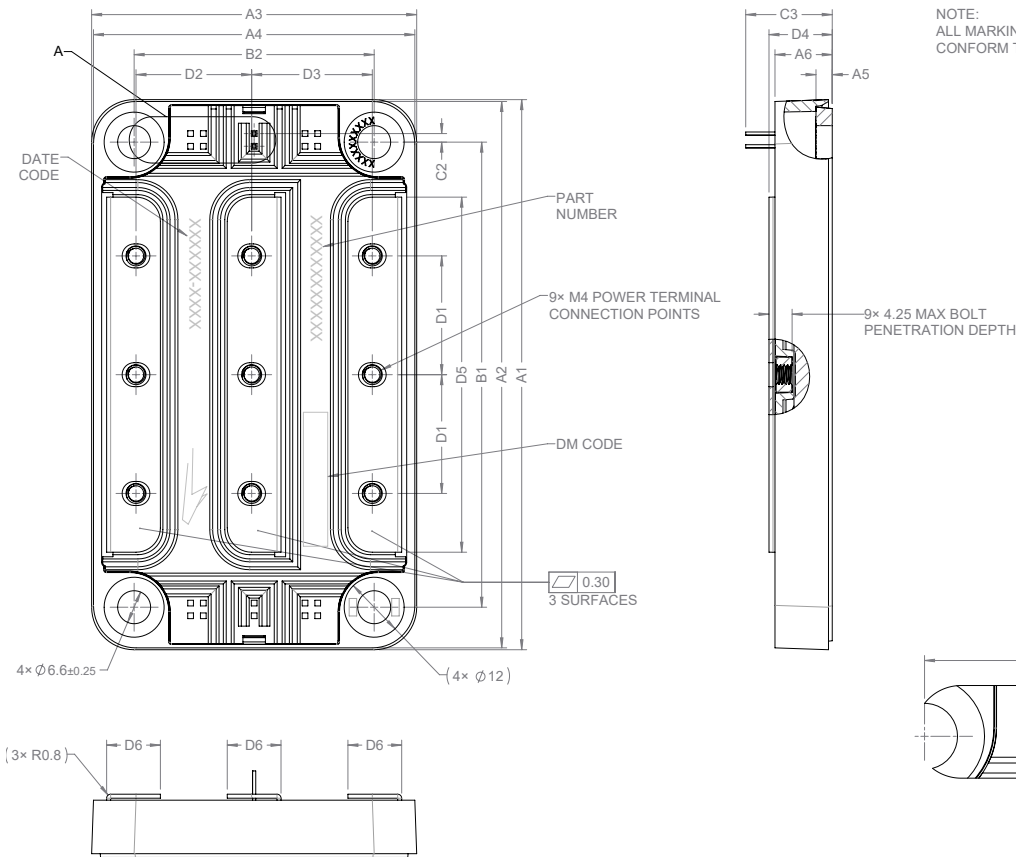

NOTE:
ALL MARKINGS SHALL
CONFORM TO PRC-00786.

DIMENSION TABLE		
SYMBOL	DIMENSION	TOLERANCE
A1	110.00	±0.60
A2	109.25	±0.60
A3	65.00	±0.60
A4	64.25	±0.60
A5	3.25	±0.30
A6	11.45	±0.60
B1	93.00	±0.30
B2	48.00	±0.30
C1	24.00	±0.40
C2	1.71	±0.40
C3	17.30	±0.50
C4	2.54	±0.30
C5	0.64	±0.30
D1	23.75	±0.50
D2	23.13	±0.50
D3	24.13	±0.50
D4	12.20	±0.50
D5	71.00	±0.30
D6	10.75	±0.30

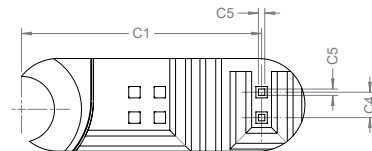

DETAIL A
SCALE: 4:1



Supporting Links & Tools

Evaluation Tools & Support

- [CAR600M17HN6 PLECS Model](#)
- [SpeedFit 2.0 Design Simulator™](#)
- [Technical Support Forum](#)

Application Notes

- [CPWR-AN35: 62mm Thermal Interface Material Application Note](#)
- [CPWR-AN39: KIT-CRD-CIL12N-HM User Guide](#)



Notes & Disclaimer

This document and the information contained herein are subject to change without notice. Any such change shall be evidenced by the publication of an updated version of this document by Cree. No communication from any employee or agent of Cree or any third party shall effect an amendment or modification of this document. No responsibility is assumed by Cree for any infringement of patents or other rights of third parties which may result from use of the information contained herein. No license is granted by implication or otherwise under any patent or patent rights of Cree.

Notwithstanding any application-specific information, guidance, assistance, or support that Cree may provide, the buyer of this product is solely responsible for determining the suitability of this product for the buyer's purposes, including without limitation for use in the applications identified in the next bullet point, and for the compliance of the buyers' products, including those that incorporate this product, with all applicable legal, regulatory, and safety-related requirements.

This product has not been designed or tested for use in, and is not intended for use in, applications in which failure of the product would reasonably be expected to cause death, personal injury, or property damage, including but not limited to equipment implanted into the human body, life-support machines, cardiac defibrillators, and similar emergency medical equipment, aircraft navigation, communication, and control systems, aircraft power and propulsion systems, air traffic control systems, and equipment used in the planning, construction, maintenance, or operation of nuclear facilities.

RoHS Compliance

The levels of RoHS restricted materials in this product are below the maximum concentration values (also referred to as the threshold limits) permitted for such substances, or are used in an exempted application, in accordance with EU Directive 2011/65/EC (RoHS2), as implemented January 2, 2013. RoHS Declarations for this product can be obtained from your Cree representative or from the Product Documentation sections of www.cree.com.

REACH Compliance

REACH substances of high concern (SVHCs) information is available for this product. Since the European Chemical Agency (ECHA) has published notice of their intent to frequently revise the SVHC listing for the foreseeable future, please contact your Cree representative to ensure you get the most up-to-date REACH SVHC Declaration. REACH banned substance information (REACH Article 67) is also available upon request.

Contact info:

4600 Silicon Drive
Durham, NC 27703 USA
Tel: +1.919.313.5300
www.wolfspeed.com/power