

## SPECIFICATION

Part No. : **CAB.W13**

Product Name : Taoglas Cable Assembly  
NMO Magnet Mount - 3/4 inch Style Brass Mount type to  
FME(F) Straight Jack  
with 17ft(5182mm) RG-58 cable

Photo :



## 1. Cable Insertion Loss

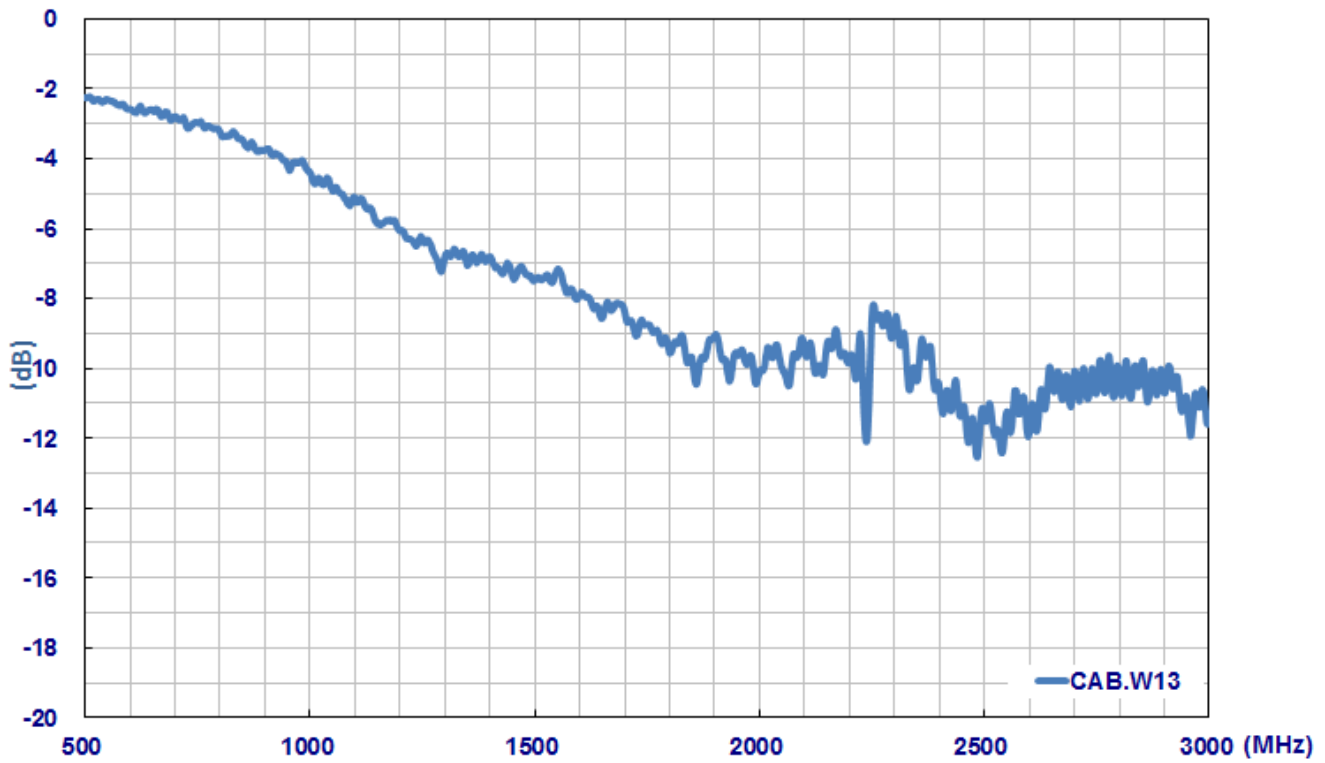

## 2. RG-58 Cable Specification

### 2.1 Drawing – Cross Section

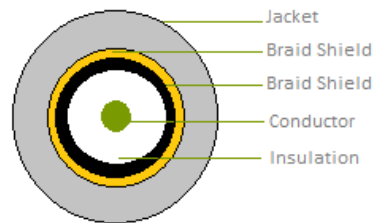

### 2.2 Structure and Dimensions

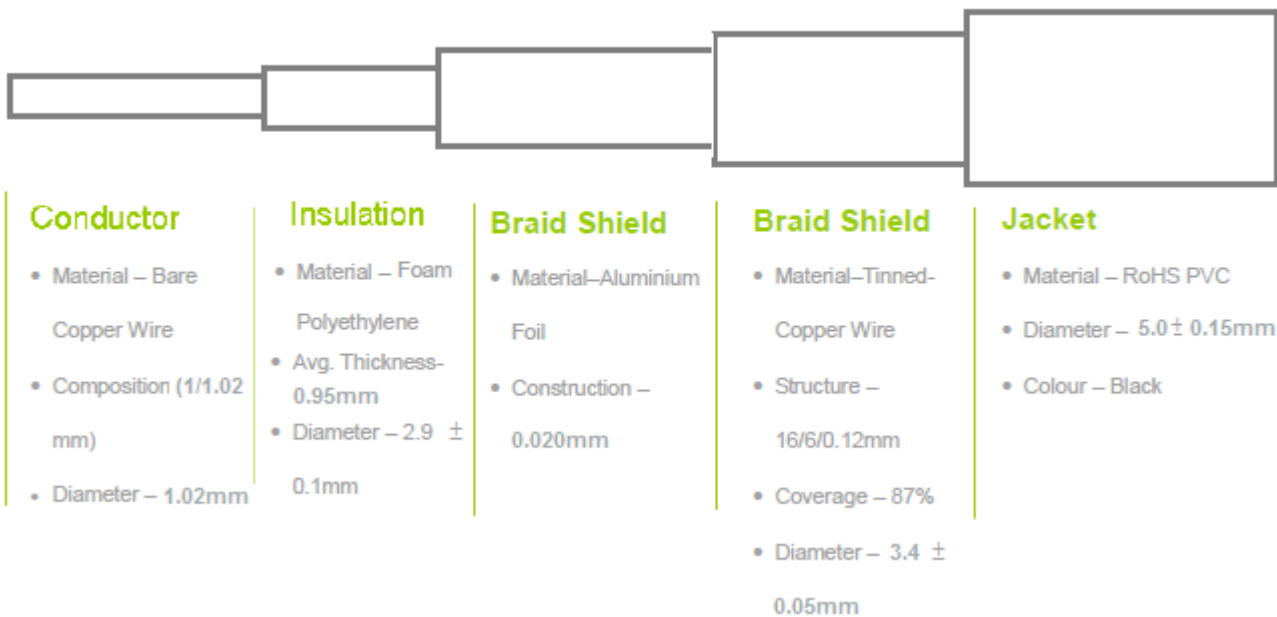

### 2.3 Electrical & Physical Specification

Insulation Resistance:	1000 MΩ-Km (Min)				
Capacitance	83 ± 3 pF/m				
Nom. Impedance	53 ± 3 Ω				
Attenuation (dB/100ft)	200MHz	400MHz	700MHz	900MHz	1000MHz
	4.66	6.32	8.45	9.67	10.2

### 3. Technical Drawing

#### 3.1 CAB.W13

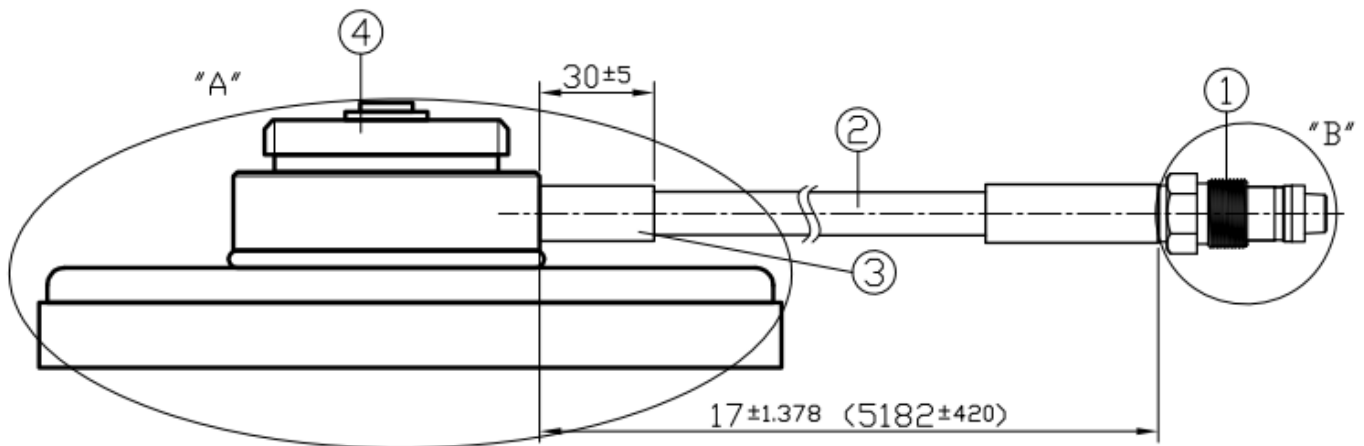

	Name	Material	Finish	QTY
1	FME(F) ST	Brass	Ni Plated	1
2	RG58 Coaxial Cable	PVC	Black	1
3	Heat Shrink Tube	PE	Black	1
4	NMO(MM)	Brass	Ni Plated	1

### 3.2 Connectors

