



TAOGLAS®



Datasheet

Part No:
CA.50

Description:
5150-5900 MHz Ceramic Chip Monopole Wi-Fi Antenna

Features:
Dimensions: 3.2mm * 1.6mm * 0.5mm
Low profile
Peak gain 3.4 dBi
Compact Size
RoHS & Reach Compliant

1. Introduction	3
2. Specifications	5
3. Antenna Characteristics	6
4. Radiation Patterns	8
5. Mechanical Drawing – Antenna	10
6. Antenna Integration Guide	12
7. Mechanical Drawing – Evaluation Board	19
8. Soldering Conditions	20
9. Packaging	21
Changelog	22

Taoglas makes no warranties based on the accuracy or completeness of the contents of this document and reserves the right to make changes to specifications and product descriptions at any time without notice. Taoglas reserves all rights to this document and the information contained herein. Reproduction, use or disclosure to third parties without express permission is strictly prohibited.



1. Introduction



Taoglas' 5150-5900 MHz ceramic chip antenna is specifically designed for Wi-Fi/ WHDMI/ High Bandwidth 5GHz Wi-Fi band applications. It is a high efficiency miniature SMD edge mounted ceramic monopole antenna with small footprint requirement. This ceramic chip antenna uses the main PCB as its ground plane, thereby increasing antenna efficiency. It is tuned for different PCB sizes by simply changing the value of the matching circuit. The CA.50's electrical properties are symmetrical therefore the antenna can be soldered to the board from either side. At 3.2mm*1.6mm*0.5mm, it is one of the smallest antennas available worldwide. This antenna is delivered on tape and reel.

Typical Applications Include:

- USB Dongles
- High Bandwidth Video Transmission
- WHDMI PCMCIA Cards
- Wearables
- Smart Healthcare

Many module manufacturers specify peak gain limits for any antennas that are to be connected to that module. Those peak gain limits are based on free-space conditions. In practice, the peak gain of an antenna tested in free space can degrade by at least 1 or 2dBi when put inside a device. So ideally you should go for a slightly higher peak gain antenna than mentioned on the module specification to compensate for this effect, giving you better performance.

Upon testing of any of our antennas with your device and a selection of appropriate layout, integration technique, or cable, Taoglas can make sure any of our antennas' peak gain will be below the peak gain limits. Taoglas can then issue a specification and/or report for the selected antenna in your device that will clearly show it complying with the peak gain limits, so you can be assured you are meeting regulatory requirements for that module.

For example, a module manufacturer may state that the antenna must have less than 2dBi peak gain, but you don't need to select an embedded antenna that has a peak gain of less than 2dBi in free space. This will give you a less optimized solution. It is better to go for a slightly higher free-space peak gain of 3dBi or more if available. Once that antenna gets integrated into your device, performance will degrade below this 2dBi peak gain due to the effects of GND plane, surrounding components, and device housing. If you want to be absolutely sure, contact Taoglas and we will test. Choosing a Taoglas antenna with a higher peak gain than what is specified by the module manufacturer and enlisting our help will ensure you are getting the best performance possible without exceeding the peak gain limits.

This antenna can be mounted with no performance degradation in either orientation as long as the antenna is soldered correctly via Surface mounting. Please see the integration instructions section for further detail regarding the optimum way to integrate this antenna into your device

For further information on how to integrate this product, please contact your regional Taoglas customer support team.



2. Specifications

LTE Antenna										
Frequency (MHz)	5000	5100	5200	5300	5400	5500	5600	5700	5800	5900
Efficiency (%)										
40 x 40 mm Ground Plane	66.8	65.8	78.9	65.6	69.7	80	72.4	65.6	74.5	55.9
Average Gain (dB)										
40 x 40 mm Ground Plane	-1.75	-1.8	-1	-1.8	-1.6	-1	-1.4	-1.8	-1.3	-2.5
Peak Gain (dBi)										
40 x 40 mm Ground Plane	2.7	2	3.2	2.3	2.8	3.4	3.1	2.8	3.6	2.6
VSWR	2 max.									
Impedance (Ω)	50 Ω									
Polarization	Linear									
Radiation Pattern	Omni									
Input Power(W)	50									
Mechanical										
Dimensions (mm)	3.2 x 1.6 x 0.5									
Ground plane (mm)	40 x 40									
Material	AS 6									
Mechanical										
Temperature Range	-40°C to 85°C									
Temperature Coefficient of Frequency (ppm/°C)	0±20 max. (@-40°C to 85°C)									
Humidity	Non-condensing 65°C 95% RH									
Moisture Sensitivity Level	3 (168 Hours)									

3. Antenna Characteristics

3.1 Return Loss

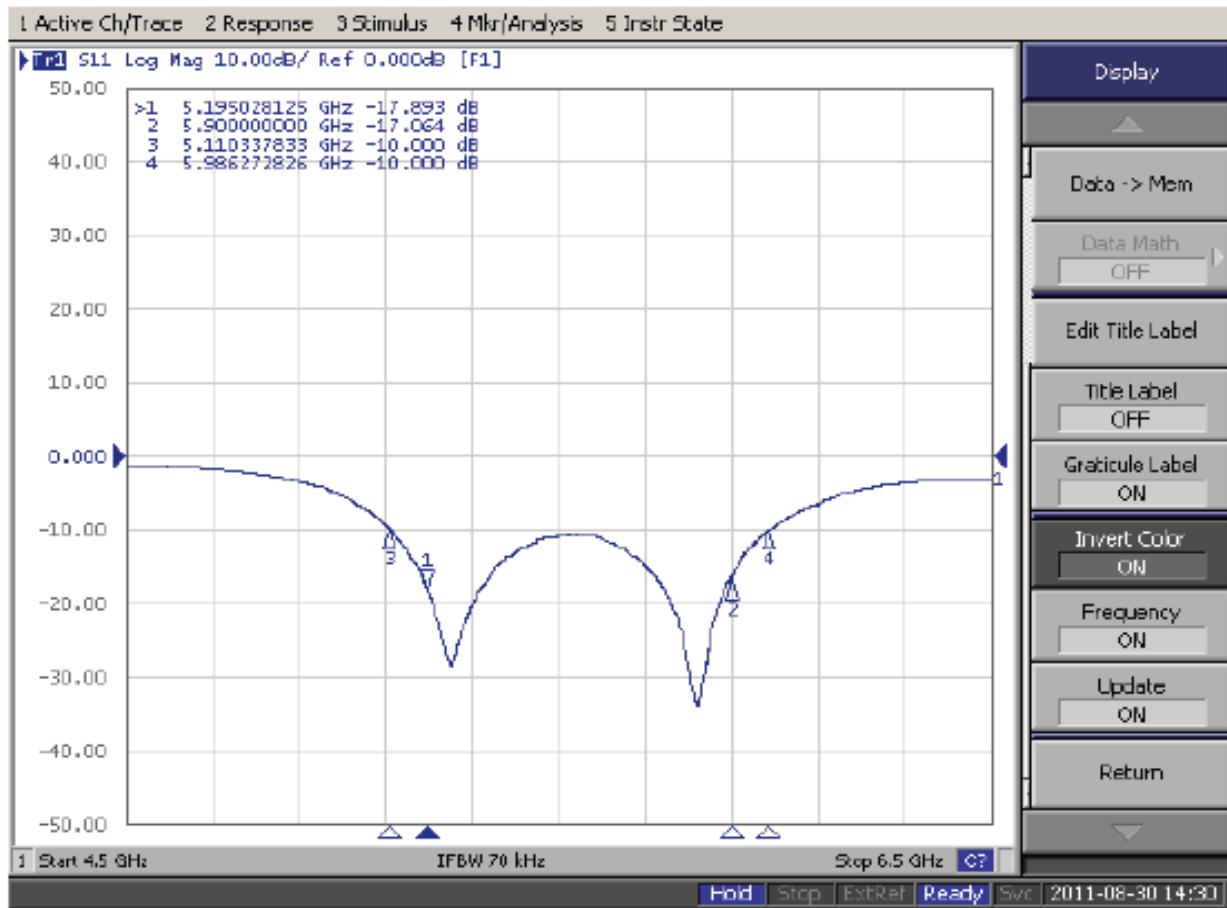

3.2 Smith Chart

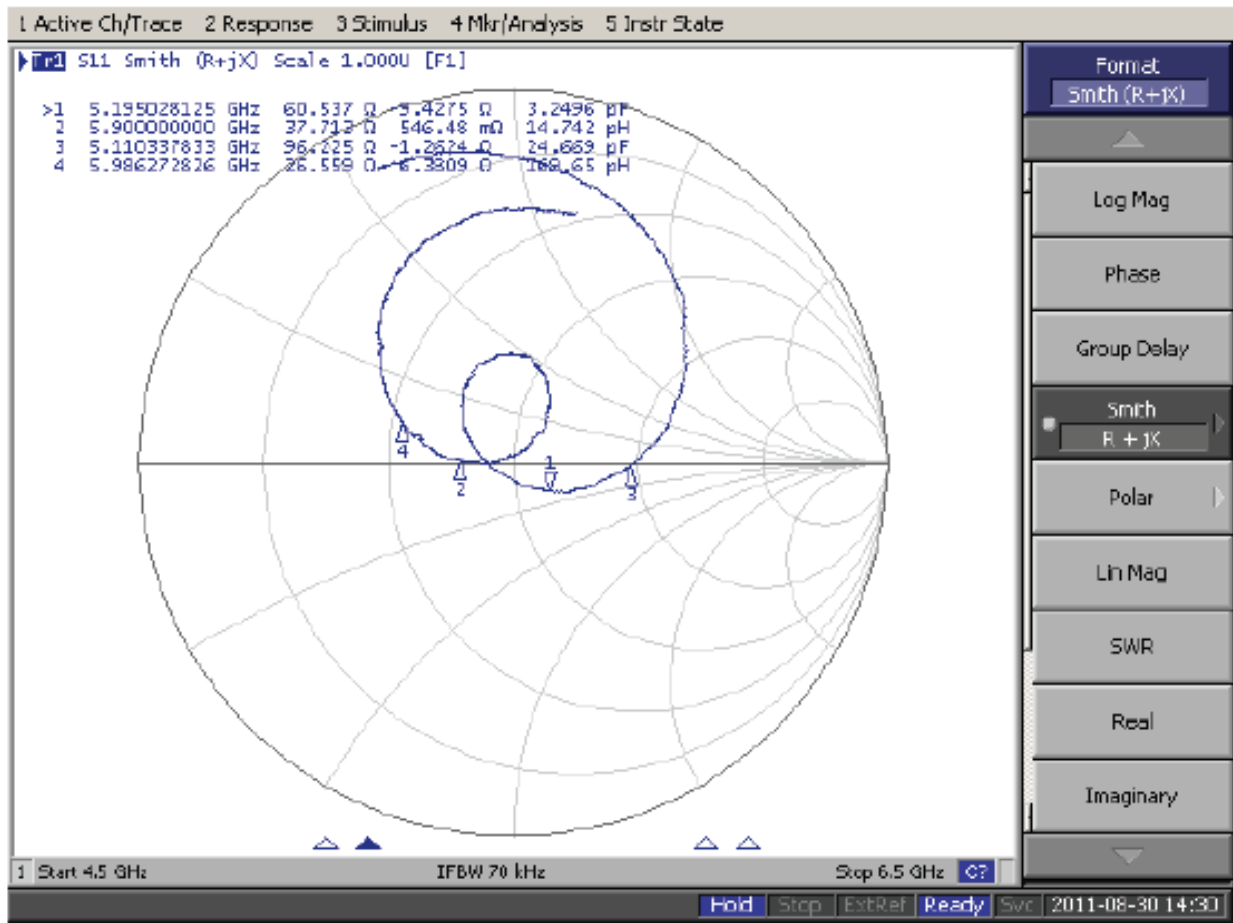

3.3 Efficiency

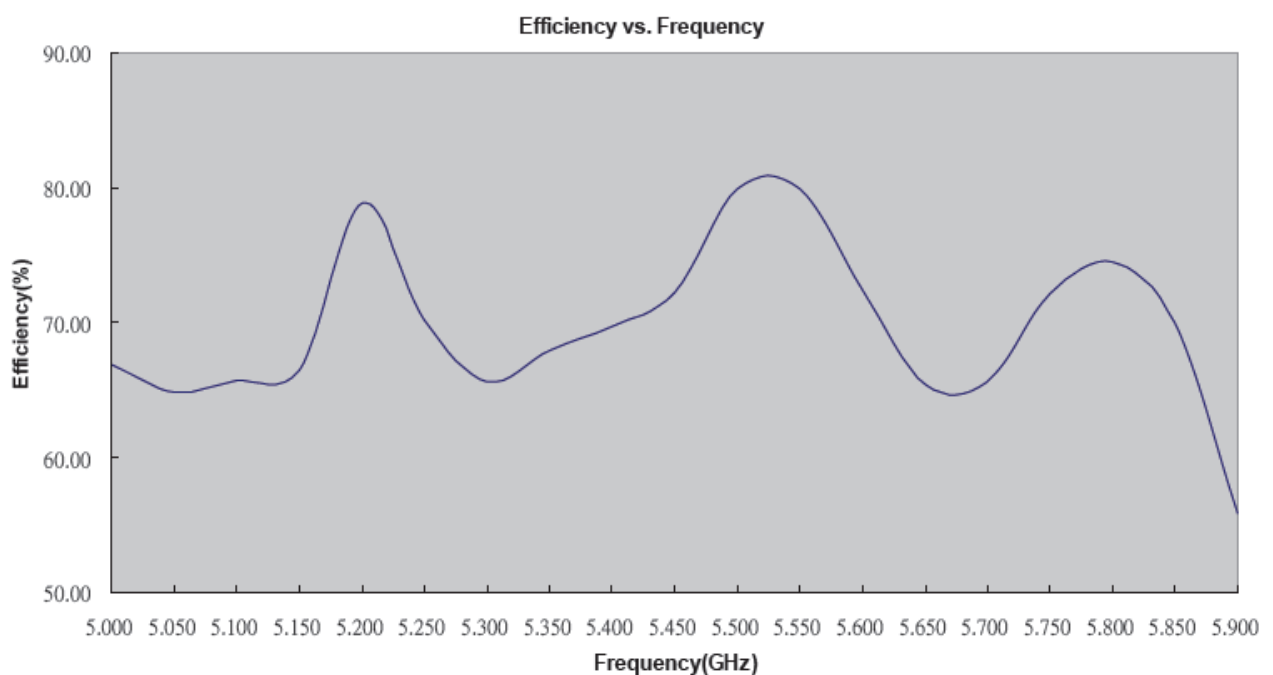

4. Radiation Patterns

4.1 Test Setup – 40 x 40 mm Ground Plane

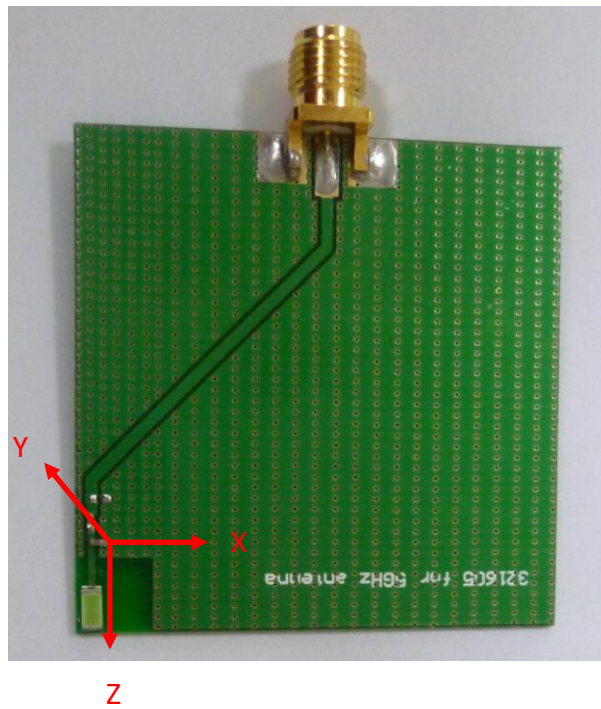

4.2 5150MHz Radiation Patterns

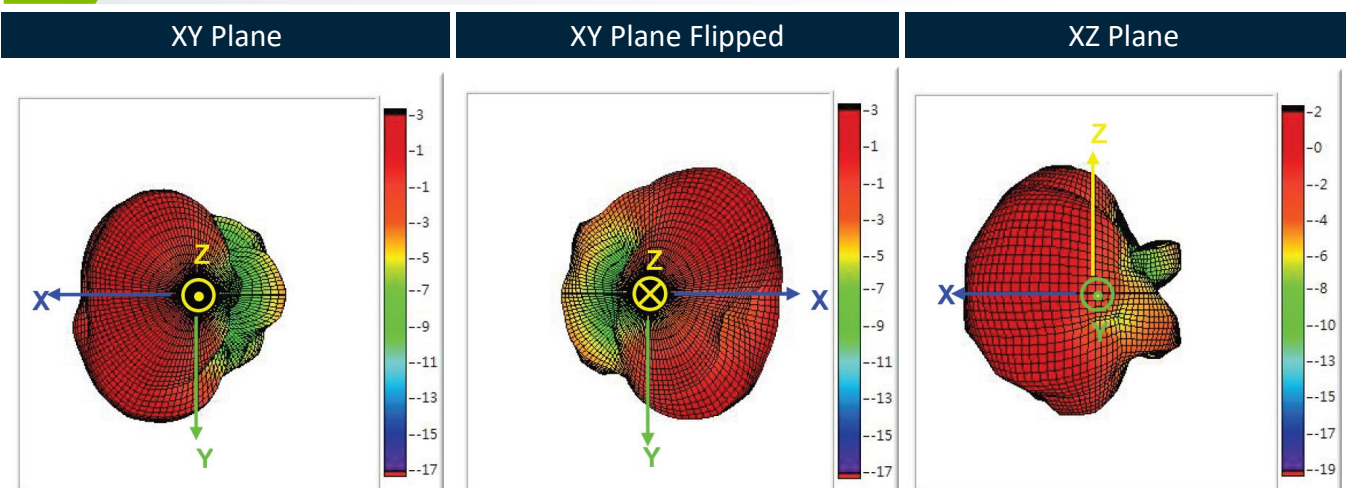

4.3 5350MHz Radiation Patterns

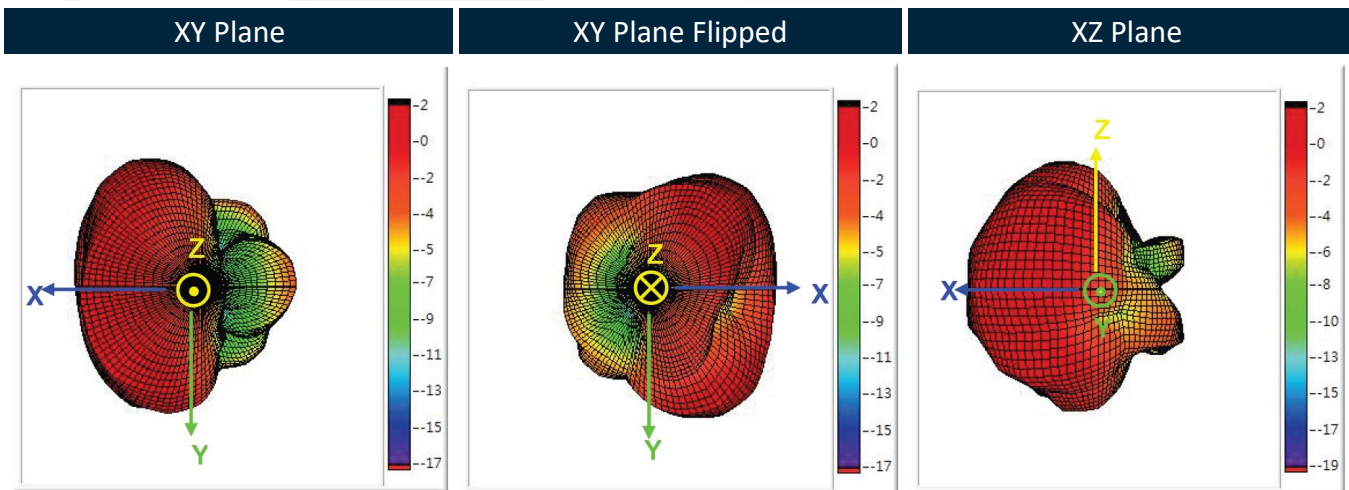

4.4 5700MHz Radiation Patterns

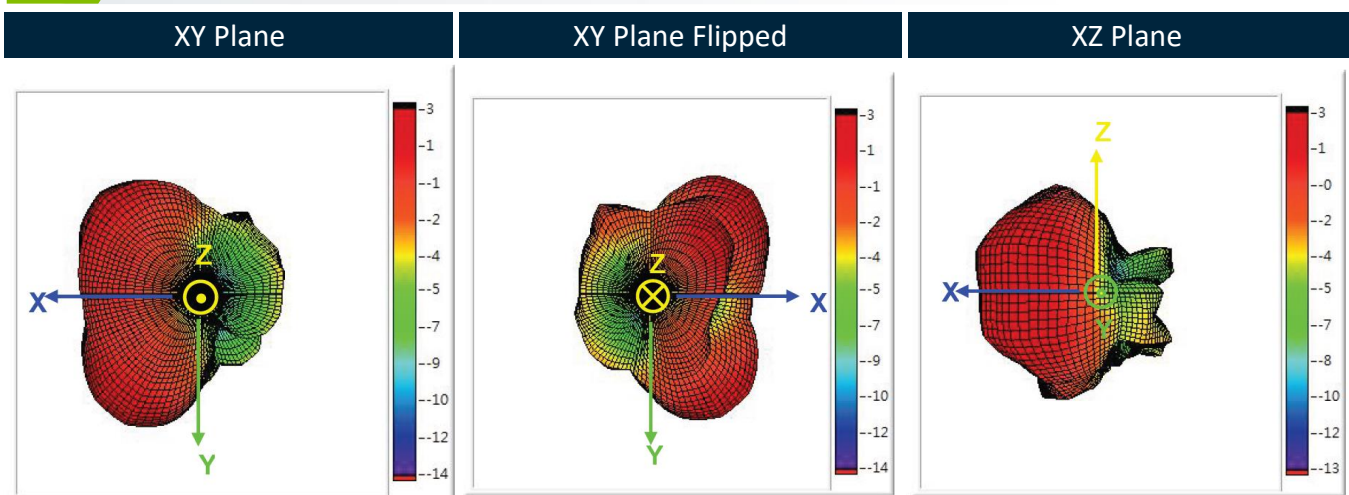

4.5 5850MHz Radiation Patterns

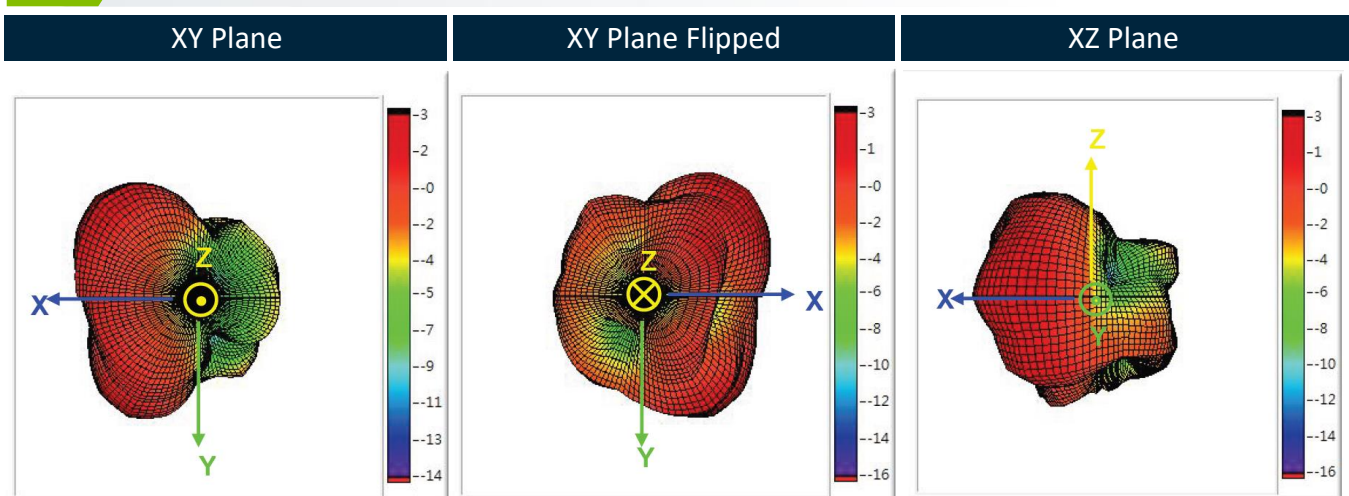

5. Mechanical Drawing – Antenna

5.1 Antenna Dimension and Drawing

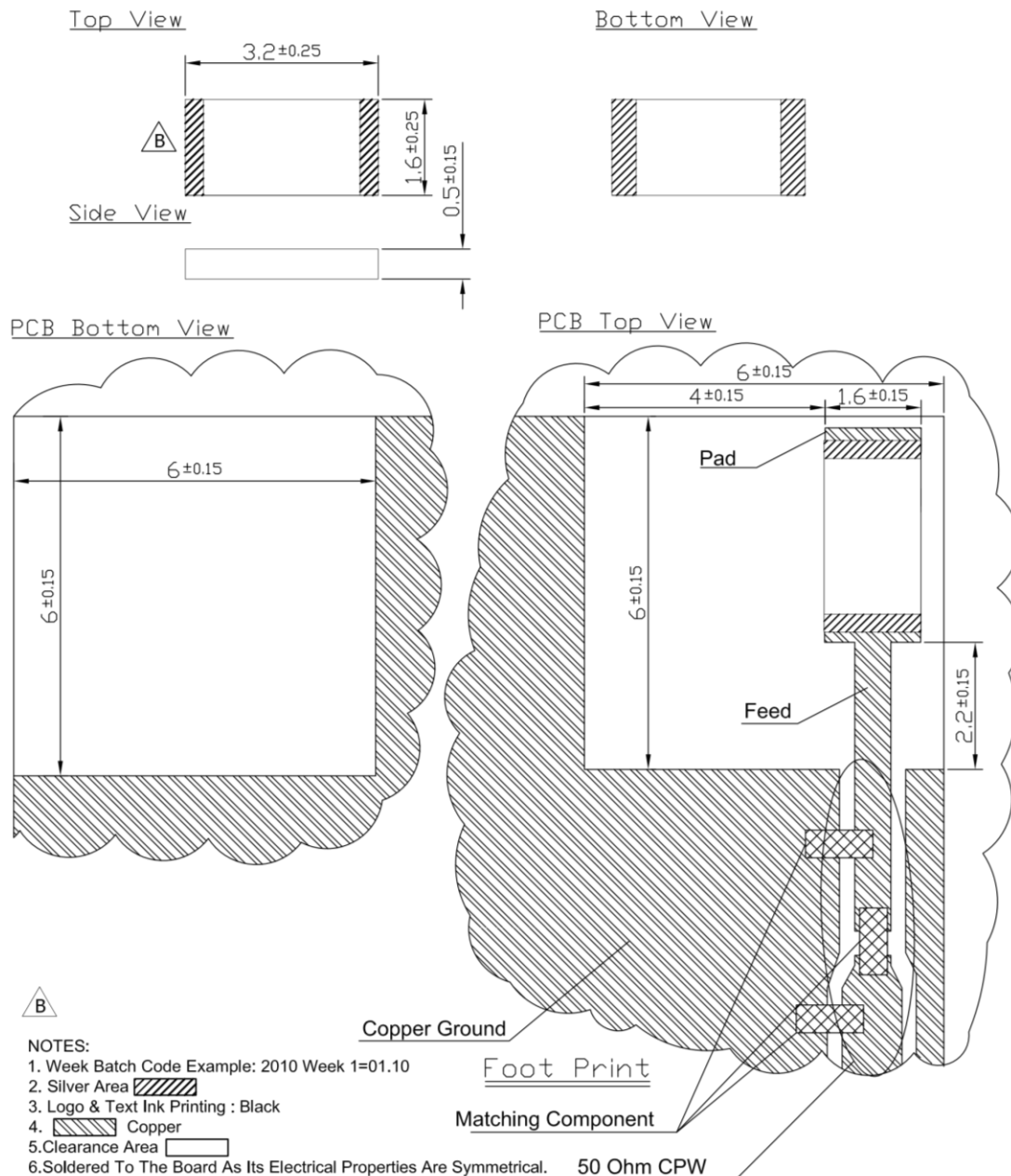

5.2 Antenna Footprint

RELEASE

...CONTINUED FROM PREVIOUS SHEET

4 SOLDER PADS
5 COPPER

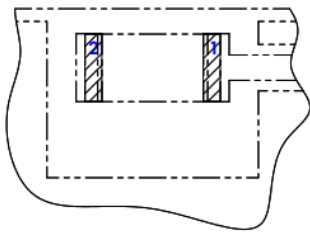

SOLDER PAD FOOTPRINT WITH PCB OUTLINE
SCALE 10:1

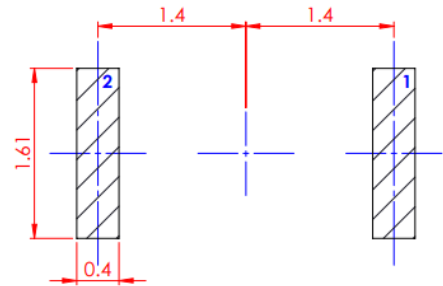

FOOTPRINT PCB
SCALE 25:1

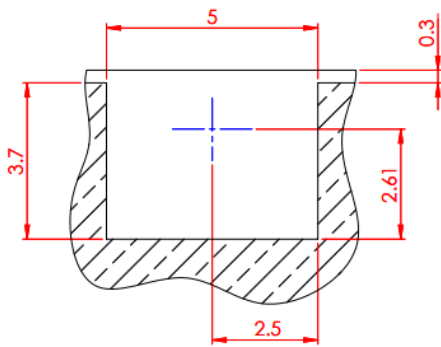

GROUND CLEARANCE BOTTOM VIEW
(SILKSCREEN NOT SHOWN)
SCALE 10:1

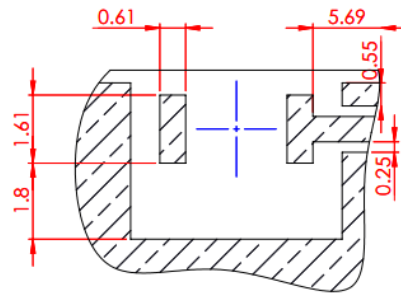
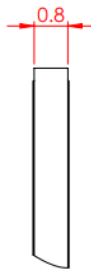

GROUND CLEARANCE TOP VIEW
(SILKSCREEN NOT SHOWN)
SCALE 10:1

6. Antenna Integration Guide

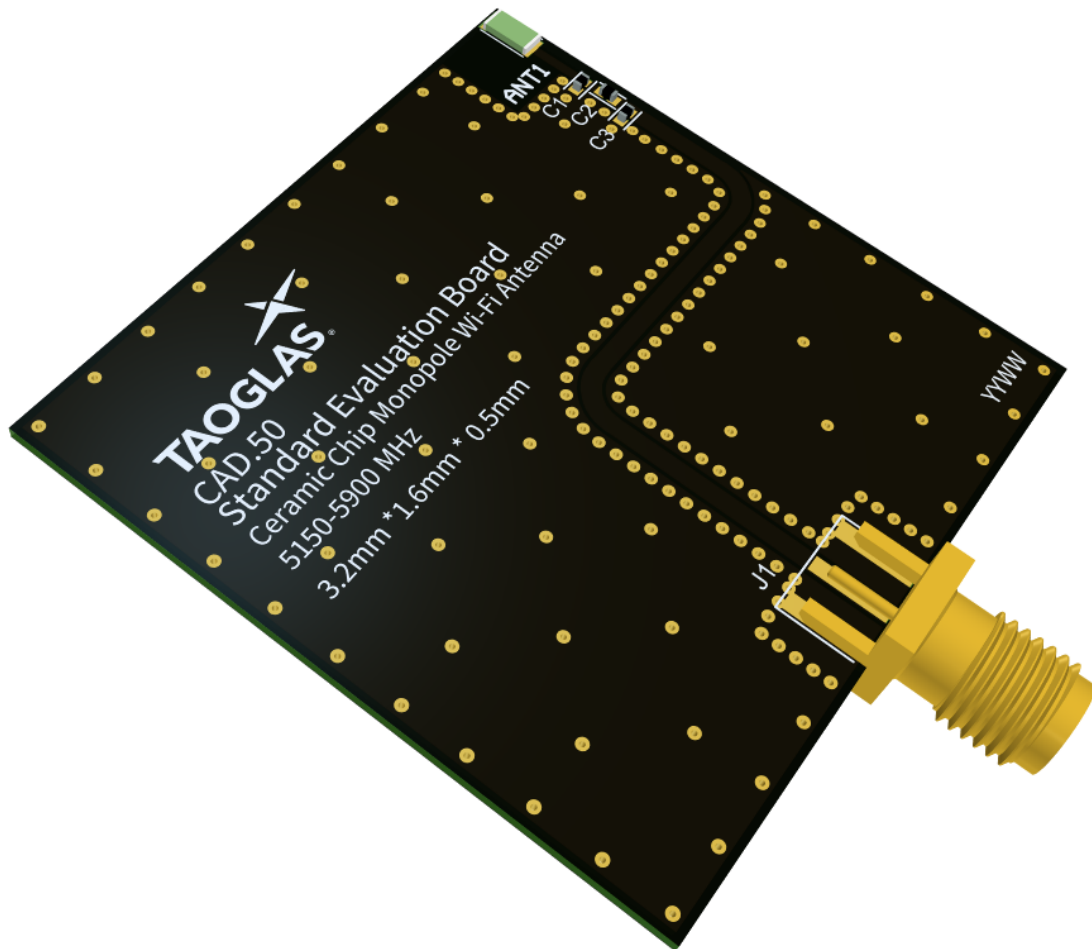
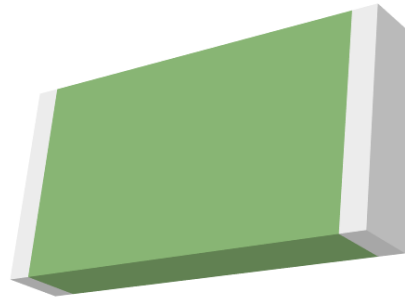

6.1 Schematic Symbol and Pin Definition

The circuit symbol for the antenna is shown below. The antenna has 2 pins with only one pin (Pin 1) as functional. Pin 2 is for mechanical strength.

Pin	Description
1	RF Feed
2	Mechanical, Not Connected

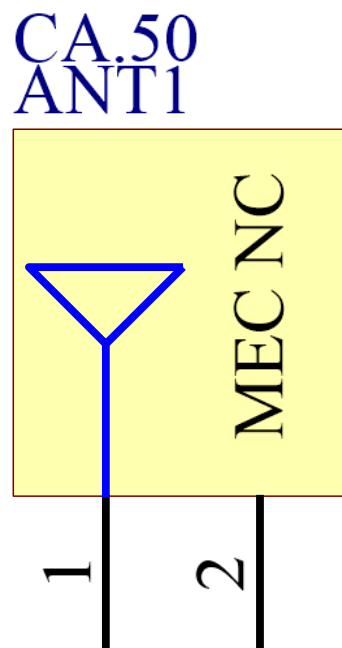

6.2 Antenna Integration

For any given PCB size, the antenna should ideally be placed on the PCB's corner, to take advantage of the ground plane. Optimized matching components can be placed as shown.

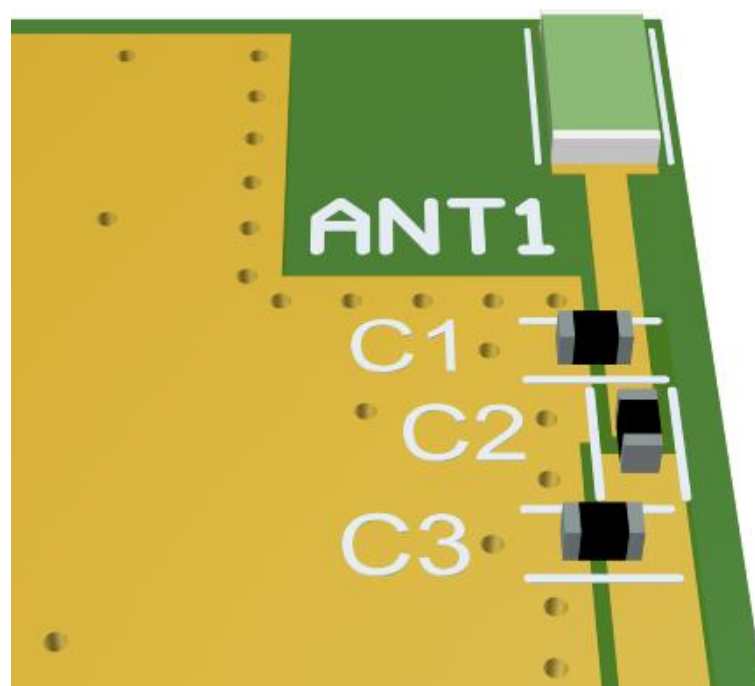
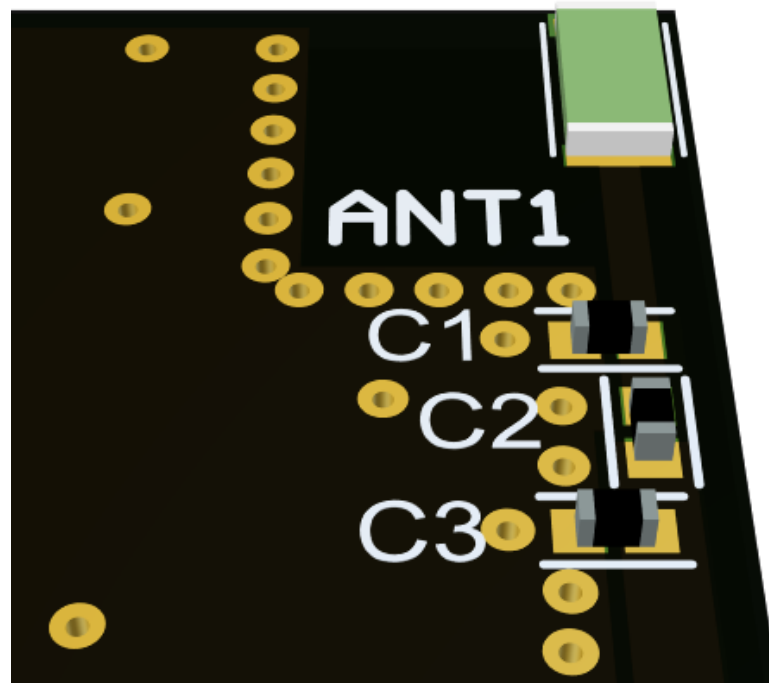

6.3 PCB Layout

The footprint and clearance on the PCB must meet the layout drawing in (Footprint Drawing). Note the placement of the optimized components. C1 is placed as close as possible to the RF feed (pad 1) but still within the transmission line. C2 is then placed tightly in series after that followed by C3 in parallel.

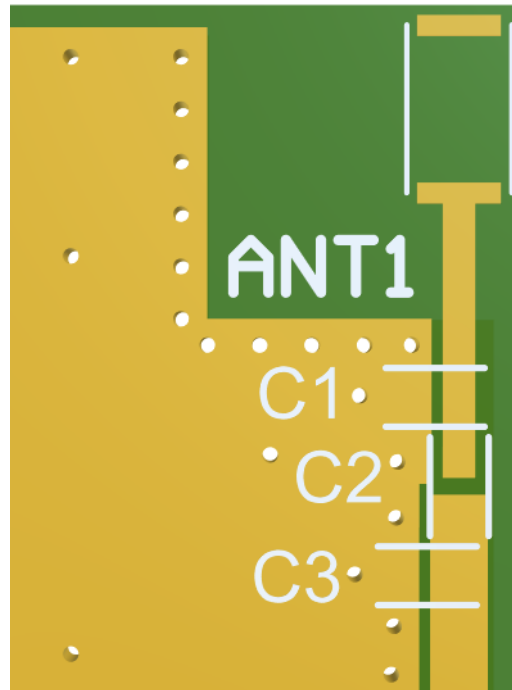

Topside

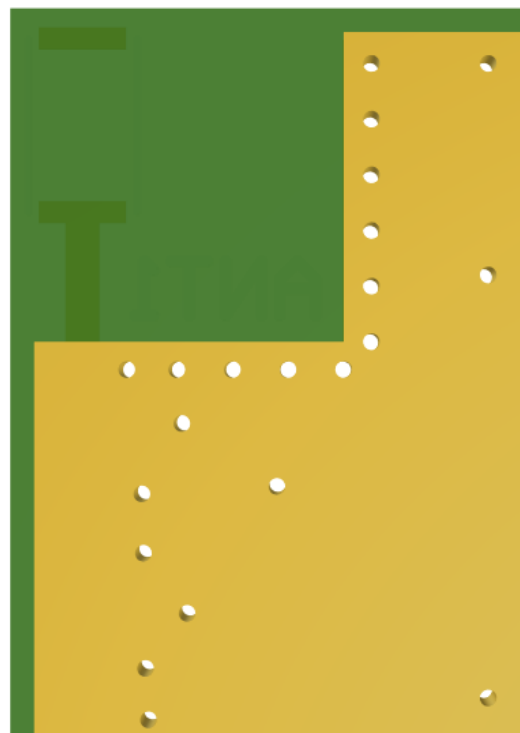

Bottom Side

6.4 PCB Keep Out

Below shows the antenna footprint and clearance through ALL layers on the PCB. Only the antenna pads and connections to feed are present within this clearance area (marked RED). The clearance area extends to 6mm in length and width from the ground area. This clearance area includes the bottom side and ALL internal layers on the PCB.

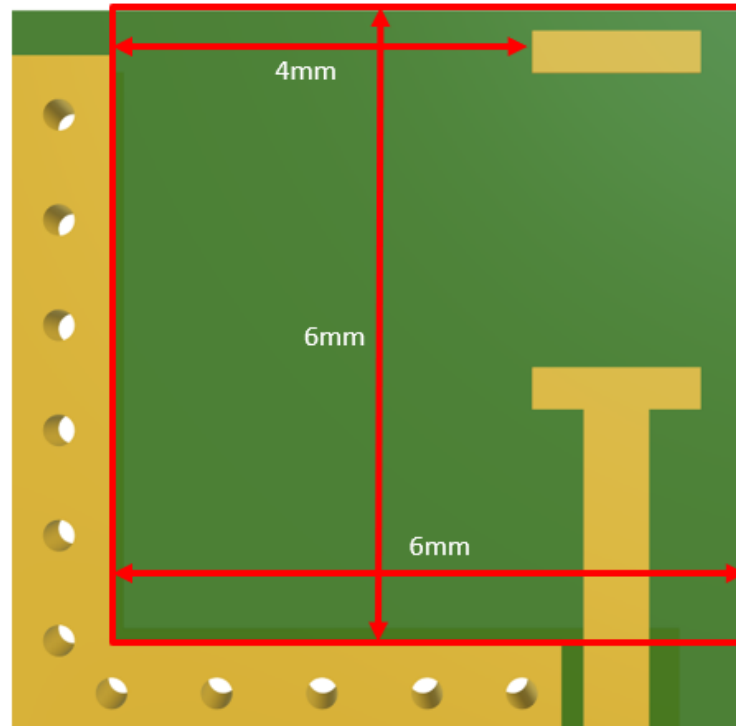

Topside

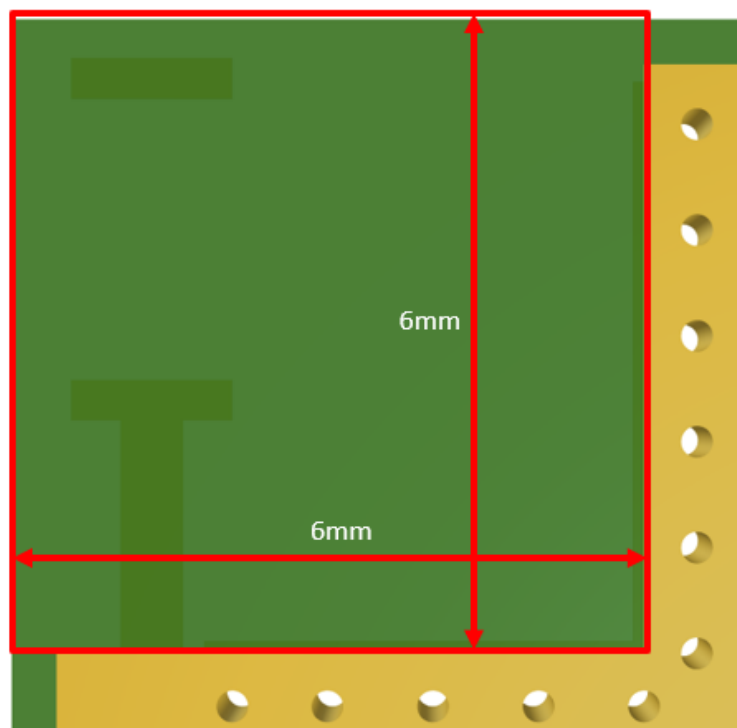

Bottom Side

6.5 Evaluation Board

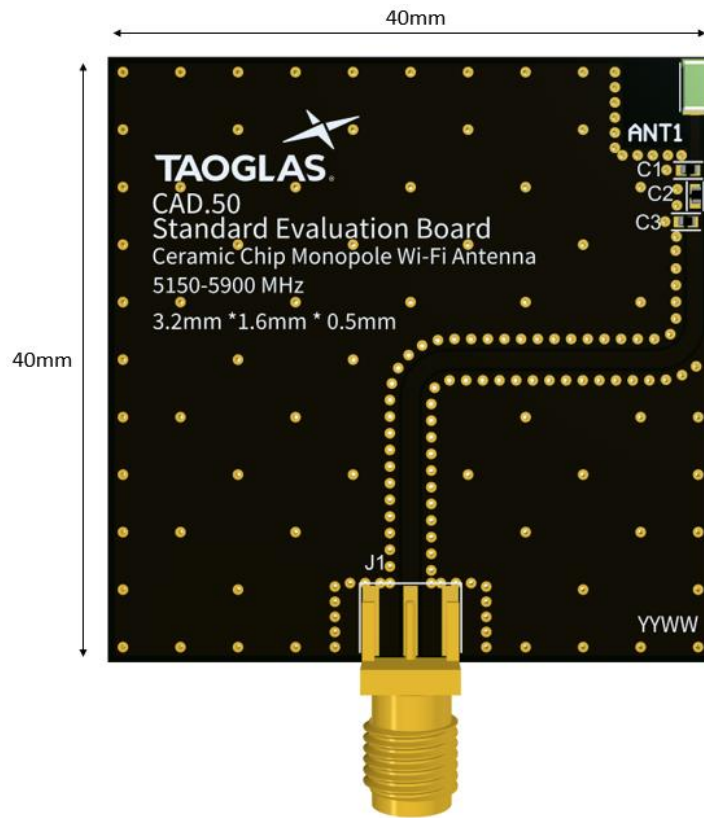

Topside

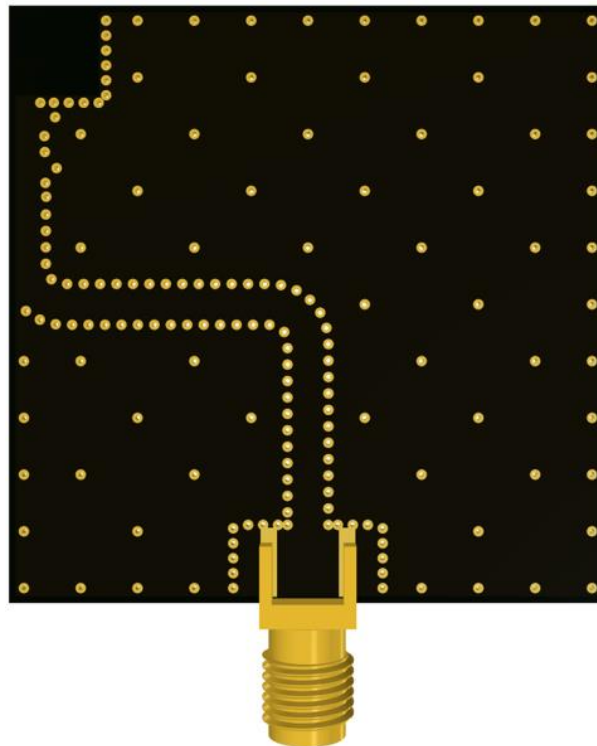

Bottom Side

6.6 Evaluation Board Matching Circuit

A matching component (C1) in parallel with the CA.50 is required for the antenna to have optimal performance on the evaluation board, located outside of the ground plane in the space specified in the above images. Additional matching components may be necessary for your device, so we recommend incorporating extra component footprints, forming a “pi” network, between the cellular module and the edge of the ground plane.

Designator	Type	Value	Manufacturer	Manufacturer Part Number
C1	Capacitor	0.3pF	Murata	GRM1555C1HR30CA01D
C2	Capacitor	4.7pF	Murata	GRM1555C1H4R7CA01D
C3	Capacitor	0.47pF	Murata	GRM1555C1HR47BA01D

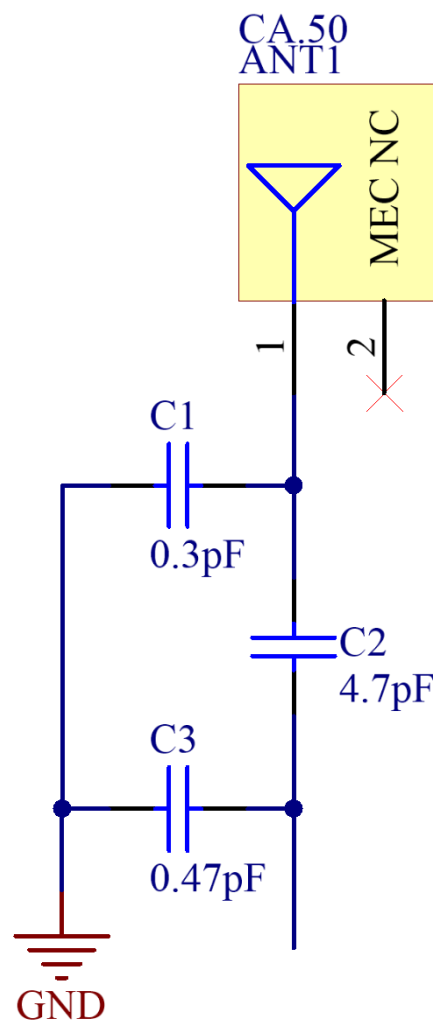

7. Mechanical Drawing – Evaluation Board

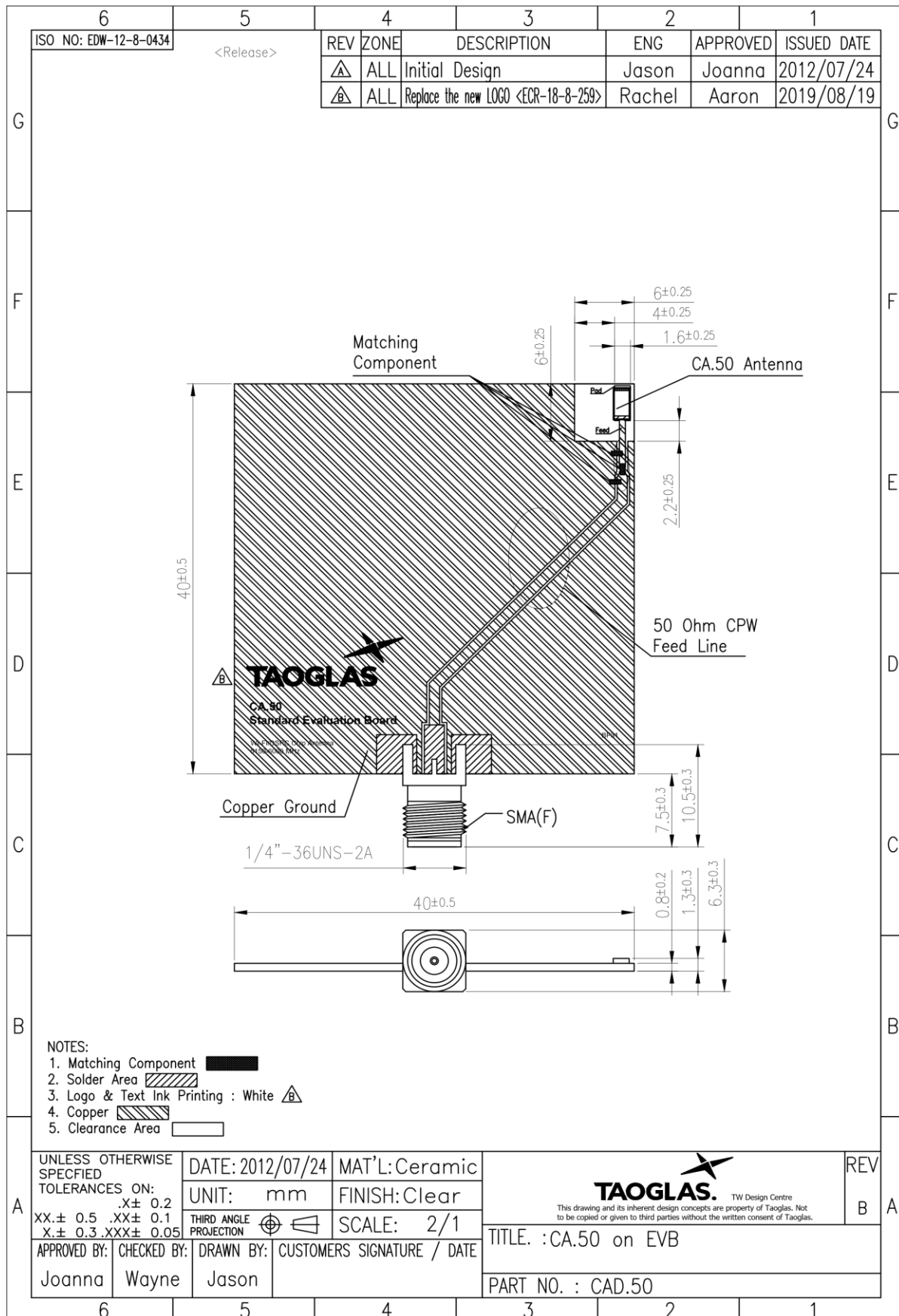

8. Soldering Conditions

Typical Soldering profile for lead-free process:

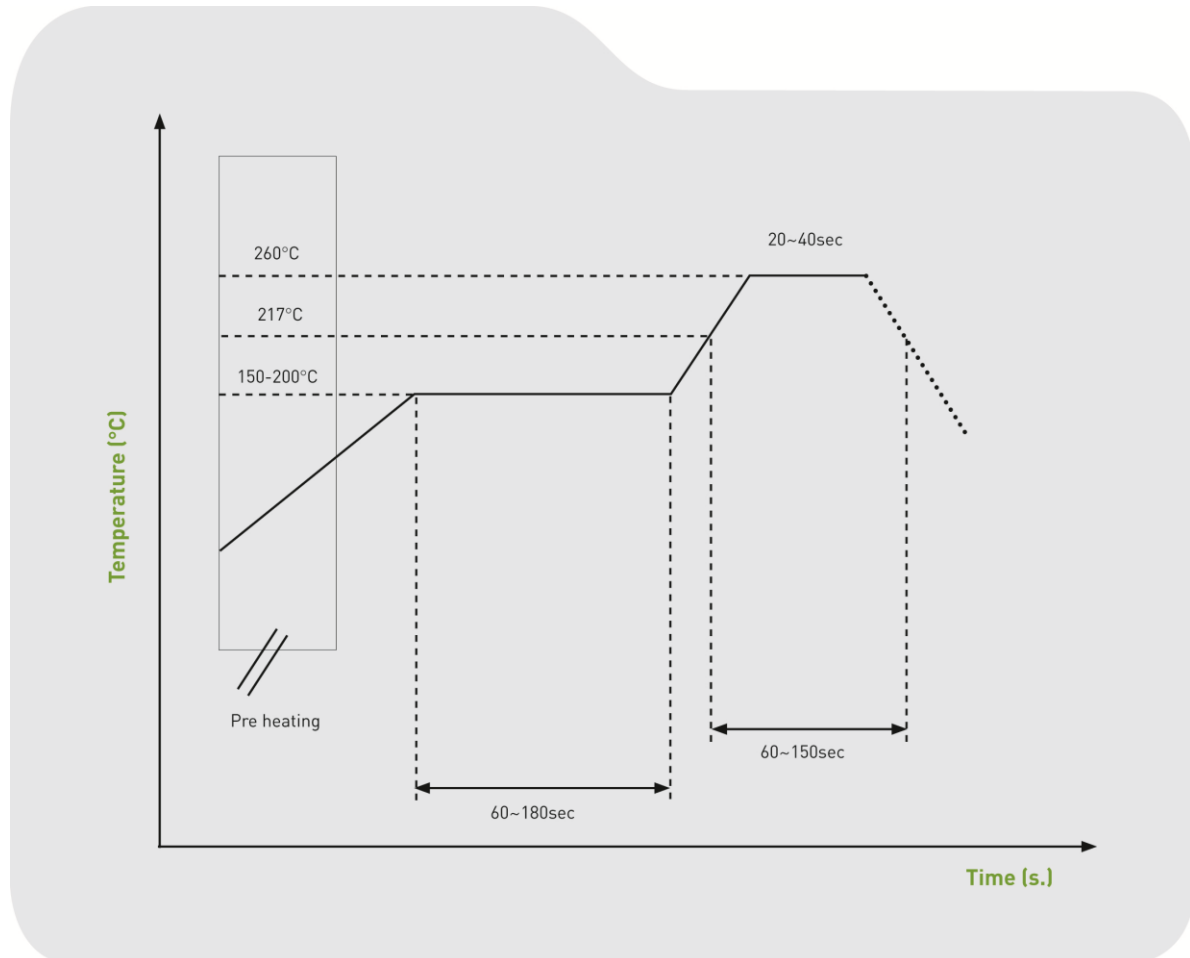

9. Packaging

Quantity: 6000pcs per reel

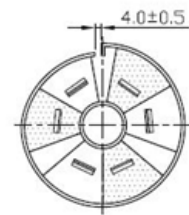
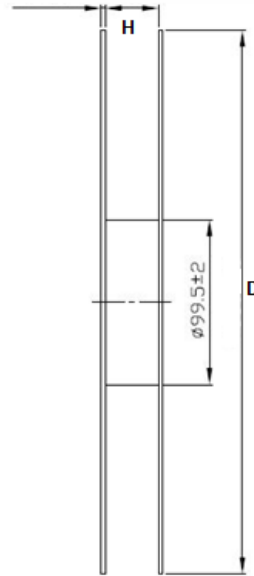
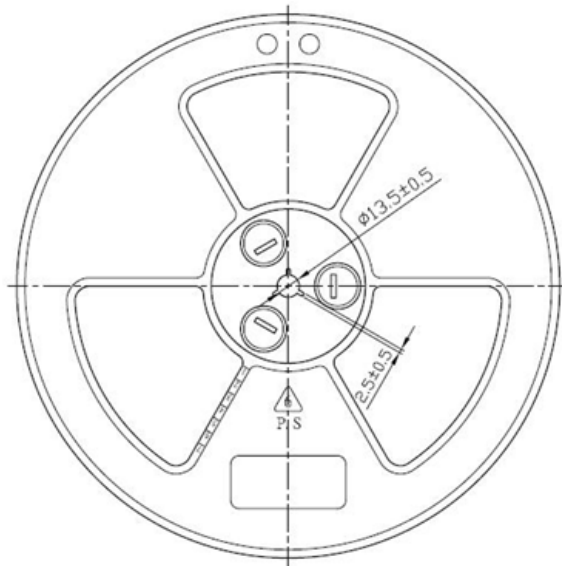

Changelog for the datasheet

SPE-17-8-042 – CA.50

Revision: E (Current Version)

Date:	2023-03-21
Changes:	Antenna Integration Guide Added
Changes Made by:	Cesar Sousa

Previous Revisions

Revision: D

Date:	2021-09-02
Changes:	Updated MSL and Template (font)
Changes Made by:	Erik Landi

Revision: C

Date:	2020-06-02
Changes:	Updated Packaging and Template
Changes Made by:	Jack Conroy

Revision: B

Date:	2015-08-21
Changes:	Amended Intro
Changes Made by:	Aine Doyle

Revision: A (Original First Release)

Date:	2012-08-14
Notes:	Initial Release
Author:	Wayne Yang



TAOGLAS®

www.taoglas.com

