



LED Display Product Data Sheet LTC-571G

Spec No.: DS-30-96-095

Effective Date: 04/30/2000

Revision: -

LITE-ON DCC

RELEASE

BNS-OD-FC001/A4

FEATURES

- * 0.56 inch (14.2 mm) DIGIT HEIGHT.
- * CONTINUOUS UNIFORM SEGMENTS.
- * LOW POWER REQUIREMENT.
- * EXCELLENT CHARACTERS APPEARANCE.
- * HIGH BRIGHTNESS & HIGH CONTRAST.
- * WIDE VIEWING ANGLE.
- * SOLID STATE RELIABILITY.
- * CATEGORIZED FOR LUMINOUS INTENSITY.

DESCRIPTION

The LTC-571G is a 0.56 inch (14.2 mm) digit height triple digit seven-segment display. This device utilizes green LED chips, which are made from GaP on a transparent GaP substrate, and has a gray face and white segments.

DEVICE

PART NO.	DESCRIPTION
Green	Multiplex Common Cathode Rt. Hand Decimal
LTC-571G	

PACKAGE DIMENSIONS

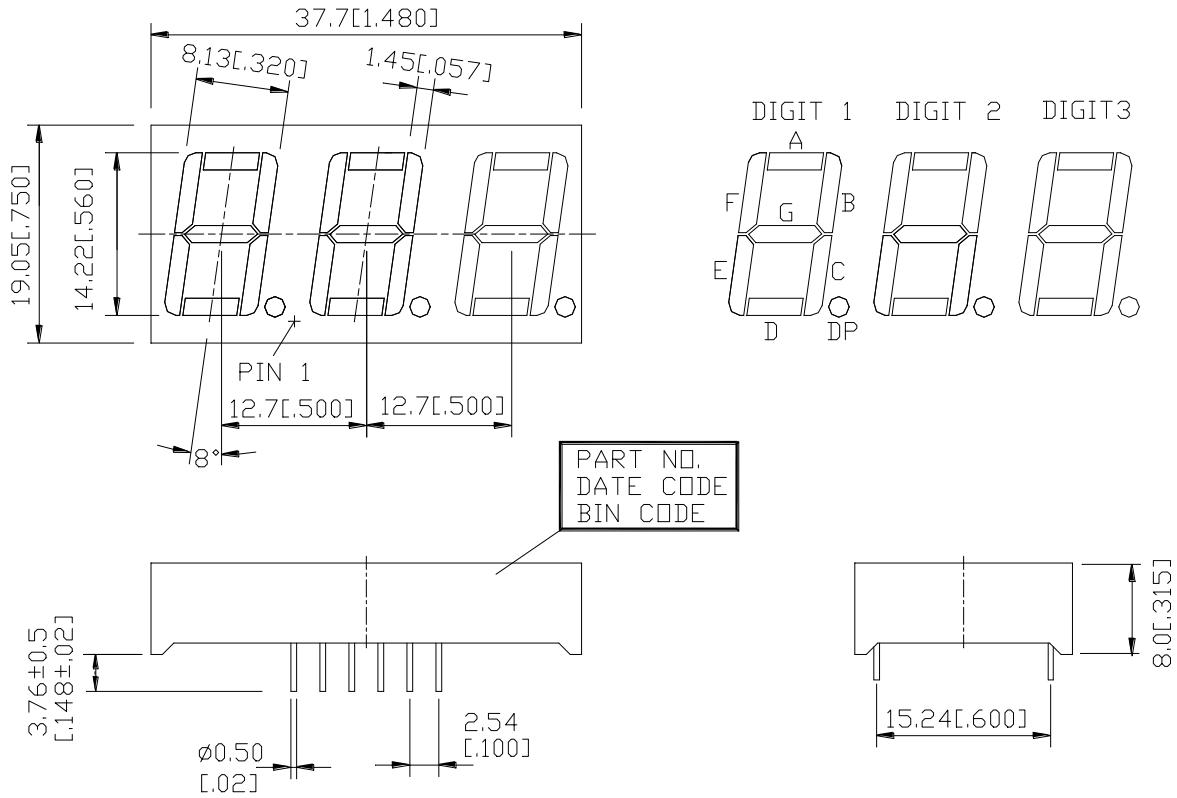

NOTES: All dimensions are in millimeters. Tolerances are ± 0.25 mm (0.01") unless otherwise noted.

INTERNAL CIRCUIT DIAGRAM

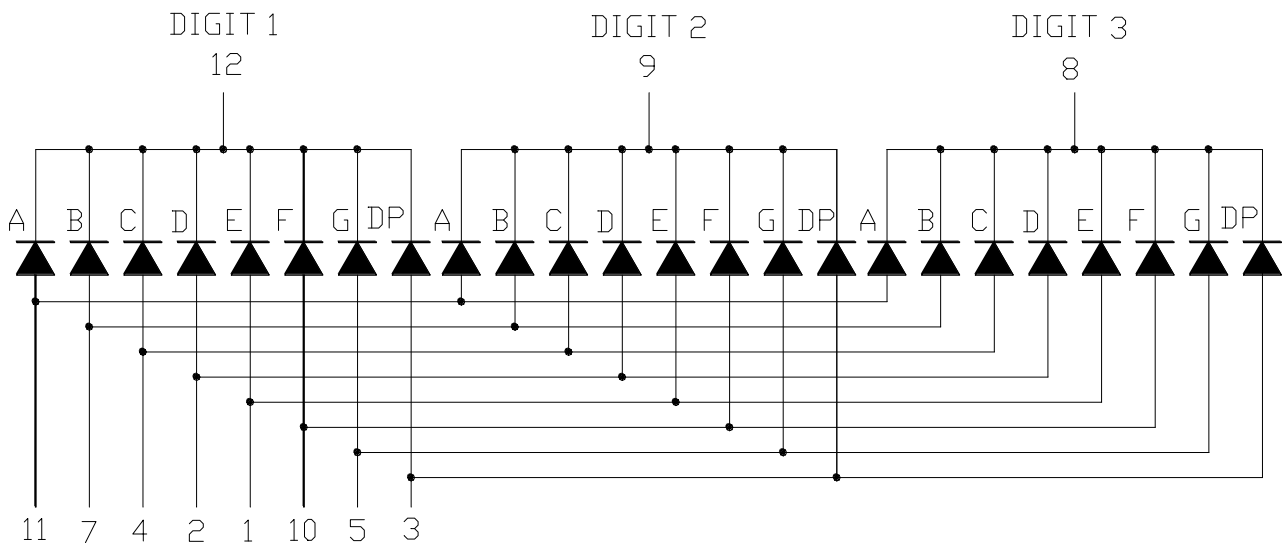

PIN CONNECTION

NO.	CONNECTION
1	ANODE E
2	ANODE D
3	ANODE D.P.
4	ANODE C
5	ANODE G
6	NO CONNECTION
7	ANODE B
8	COMMON CATHODE, DIGIT 3
9	COMMON CATHODE, DIGIT 2
10	ANODE F
11	ANODE A
12	COMMON CATHODE, DIGIT 1

ABSOLUTE MAXIMUM RATING AT Ta=25°C

PARAMETER	MAXIMUM RATING	UNIT
Power Dissipation Per Segment	75	mW
Peak Forward Current Per Segment (1/10 Duty Cycle, 0.1ms Pulse Width)	100	mA
Continuous Forward Current Per Segment Derating Linear From 25°C Per Segment	25 0.33	mA mA/°C
Reverse Voltage Per Segment	5	V
Operating Temperature Range	-35°C to +85°C	
Storage Temperature Range	-35°C to +85°C	
Solder Temperature: max 260°C for max 3sec at 1.6mm below seating plane.		

ELECTRICAL / OPTICAL CHARACTERISTICS AT Ta=25°C

PARAMETER	SYMBOL	MIN.	TYP.	MAX.	UNIT	TEST CONDITION
Average Luminous Intensity	I _v	870	2400		μcd	I _F =10mA
Peak Emission Wavelength	λ _p		565		nm	I _F =20mA
Spectral Line Half-Width	Δλ		30		nm	I _F =20mA
Dominant Wavelength	λ _d		569		nm	I _F =20mA
Forward Voltage Per Segment	V _F		2.1	2.6	V	I _F =20mA
Reverse Current Per Segment	I _R			100	μA	V _R =5V
Luminous Intensity Matching Ratio	I _v -m			2:1		I _F =10mA

Note: Luminous intensity is measured with a light sensor and filter combination that approximates the CIE (Commission Internationale De L'Eclairage) eye-response curve.

TYPICAL ELECTRICAL / OPTICAL CHARACTERISTIC CURVES

(25°C Ambient Temperature Unless Otherwise Noted)

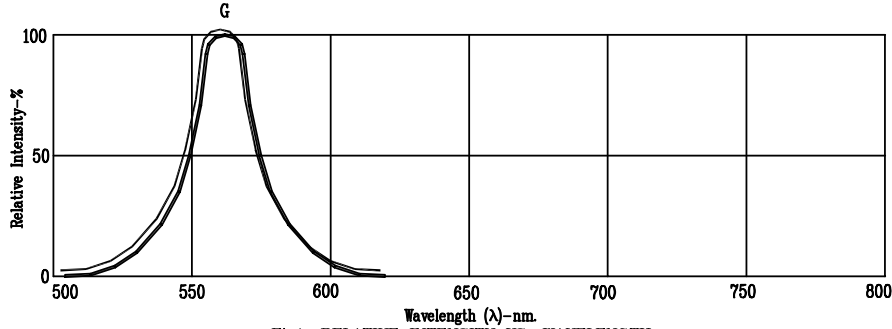

Fig1. RELATIVE INTENSITY VS. WAVELENGTH

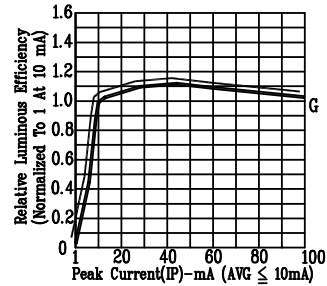

Fig2. RELATIVE LUMINOUS EFFICIENCY (LUMINOUS INTENSITY PER UNIT CURRENT) VS. PEAK CURRENT (REFRESH RATE 1KHz)

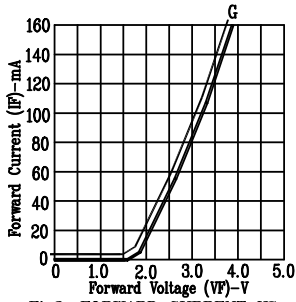

Fig3. FORWARD CURRENT VS. FORWARD VOLTAGE

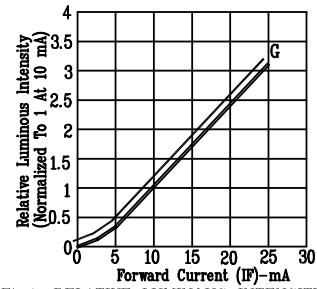

Fig4. RELATIVE LUMINOUS INTENSITY VS. FORWARD CURRENT

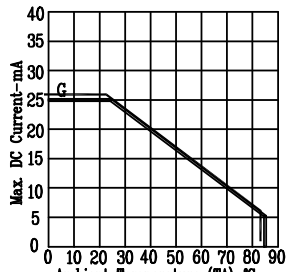

Fig5. MAX ALLOWABLE DC CURRENT VS. AMBIENT TEMPERATURE.

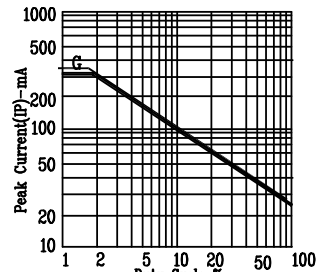

Fig6. MAX PEAK CURRENT VS. DUTY CYCLE % (REFRESH RATE 1KHz)

NOTE: G=GREEN