



# C2M0040120D

## Silicon Carbide Power MOSFET C2M™ MOSFET Technology

N-Channel Enhancement Mode

### Features

- High Blocking Voltage with Low On-Resistance
- High Speed Switching with Low Capacitances
- Easy to Parallel and Simple to Drive
- Resistant to Latch-Up
- Halogen Free, RoHS Compliant

### Benefits

- Higher System Efficiency
- Reduced Cooling Requirements
- Increased Power Density
- Increased System Switching Frequency

### Applications

- Solar Inverters
- Switch Mode Power Supplies
- High Voltage DC/DC converters
- Battery Chargers
- Motor Drives
- Pulsed Power Applications

$V_{DS}$	1200 V
$I_D @ 25^\circ\text{C}$	55 A
$R_{DS(on)}$	40 mΩ

### Package



TO-247-3

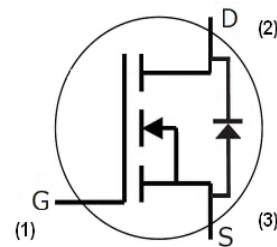

Part Number	Package	Marking
C2M0040120D	TO-247-3	C2M0040120

### Maximum Ratings ( $T_c = 25^\circ\text{C}$ unless otherwise specified)

Symbol	Parameter	Value	Unit	Test Conditions	Note
$V_{DSmax}$	Drain - Source Voltage	1200	V	$V_{GS} = 0\text{ V}, I_D = 100\ \mu\text{A}$	
$V_{GSmax}$	Gate - Source Voltage	-10/+25	V	Absolute maximum values	
$V_{GSop}$	Gate - Source Voltage	-5/+20	V	Recommended operational values	
$I_D$	Continuous Drain Current	55	A	$V_{GS} = 20\text{ V}, T_C = 25^\circ\text{C}$	Fig. 19
		36		$V_{GS} = 20\text{ V}, T_C = 100^\circ\text{C}$	
$I_{D(pulse)}$	Pulsed Drain Current	160	A	Pulse width $t_p$ limited by $T_{jmax}$	Fig. 22
$P_D$	Power Dissipation	278	W	$T_C = 25^\circ\text{C}, T_J = 150^\circ\text{C}$	Fig. 20
$T_J, T_{stg}$	Operating Junction and Storage Temperature	-55 to +150	$^\circ\text{C}$		
$T_L$	Solder Temperature	260	$^\circ\text{C}$	1.6mm (0.063") from case for 10s	
$M_d$	Mounting Torque	1 8.8	Nm lbf-in	M3 or 6-32 screw	



**Electrical Characteristics** ( $T_c = 25^\circ\text{C}$  unless otherwise specified)

Symbol	Parameter	Min.	Typ.	Max.	Unit	Test Conditions	Note
$V_{(BR)DSS}$	Drain-Source Breakdown Voltage	1200			V	$V_{GS} = 0\text{ V}, I_D = 100\ \mu\text{A}$	
$V_{GS(th)}$	Gate Threshold Voltage	2.0	3.2	4	V	$V_{DS} = V_{GS}, I_D = 10\text{mA}$	Fig. 11
			2.4		V	$V_{DS} = V_{GS}, I_D = 10\text{mA}, T_J = 150^\circ\text{C}$	
$I_{DSS}$	Zero Gate Voltage Drain Current		1	100	$\mu\text{A}$	$V_{DS} = 1200\text{ V}, V_{GS} = 0\text{ V}$	
$I_{GSS}$	Gate-Source Leakage Current			250	nA	$V_{GS} = 20\text{ V}, V_{DS} = 0\text{ V}$	
$R_{DS(on)}$	Drain-Source On-State Resistance		44	52	m $\Omega$	$V_{GS} = 20\text{ V}, I_D = 40\text{ A}$	Fig. 4,5,6
			82			$V_{GS} = 20\text{ V}, I_D = 40\text{ A}, T_J = 150^\circ\text{C}$	
$g_{fs}$	Transconductance		18.2		S	$V_{DS} = 20\text{ V}, I_{DS} = 40\text{ A}$	Fig. 7
			17.2			$V_{DS} = 20\text{ V}, I_{DS} = 40\text{ A}, T_J = 150^\circ\text{C}$	
$C_{iss}$	Input Capacitance		2440		pF	$V_{GS} = 0\text{ V}$	Fig. 17,18
$C_{oss}$	Output Capacitance		171			$V_{DS} = 1000\text{ V}$	
$C_{rss}$	Reverse Transfer Capacitance		11			$f = 1\text{ MHz}$	
$E_{oss}$	$C_{oss}$ Stored Energy		89		$\mu\text{J}$	$V_{AC} = 25\text{ mV}$	Fig 16
$E_{ON}$	Turn-On Switching Energy (Body Diode)		1.7		mJ	$V_{DS} = 800\text{ V}, V_{GS} = -5/20\text{ V}$	Fig. 25
$E_{OFF}$	Turn Off Switching Energy (Body Diode)		0.4			$I_D = 40\text{A}, R_{G(ext)} = 2.5\ \Omega, L = 99\ \mu\text{H}$	
$E_{ON}$	Turn-On Switching Energy (External SiC Diode)		1.3			$V_{DS} = 800\text{ V}, V_{GS} = -5/20\text{ V}$	
$E_{OFF}$	Turn Off Switching Energy (External SiC Diode)		0.4			$I_D = 40\text{A}, R_{G(ext)} = 2.5\ \Omega, L = 99\ \mu\text{H}$	
$t_{d(on)}$	Turn-On Delay Time		13		ns	$V_{DD} = 800\text{ V}, V_{GS} = -5/20\text{ V}$ $I_D = 40\text{ A}$ $R_{G(ext)} = 2.5\ \Omega, R_L = 20\ \Omega$ Timing relative to $V_{DS}$ Per IEC60747-8-4 pg 83	Fig. 27
$t_r$	Rise Time		61				
$t_{d(off)}$	Turn-Off Delay Time		25				
$t_f$	Fall Time		13				
$R_{G(int)}$	Internal Gate Resistance		1.8		$\Omega$	$f = 1\text{ MHz}, V_{AC} = 25\text{ mV}$	
$Q_{gs}$	Gate to Source Charge		34		nC	$V_{DS} = 800\text{ V}, V_{GS} = -5/20\text{ V}$ $I_D = 40\text{ A}$ Per IEC60747-8-4 pg 21	Fig. 12
$Q_{gd}$	Gate to Drain Charge		42				
$Q_g$	Total Gate Charge		120				



## Reverse Diode Characteristics

Symbol	Parameter	Typ.	Max.	Unit	Test Conditions	Note
V <sub>SD</sub>	Diode Forward Voltage	4.0		V	V <sub>GS</sub> = - 5 V, I <sub>SD</sub> = 20 A, T <sub>J</sub> = 25 °C	Fig. 8, 9, 10
		3.6		V	V <sub>GS</sub> = - 5 V, I <sub>SD</sub> = 20 A, T <sub>J</sub> = 150 °C	
I <sub>S</sub>	Continuous Diode Forward Current		60	A	T <sub>C</sub> = 25 °C	Note 1
I <sub>S, pulse</sub>	Diode Pulse Current		160	A	V <sub>GS</sub> = - 5 V, Pulse width t <sub>p</sub> limited by T <sub>Jmax</sub>	
t <sub>rr</sub>	Reverse Recovery Time	54		ns	V <sub>GS</sub> = - 5 V, I <sub>SD</sub> = 40 A T <sub>J</sub> = 25 °C VR = 800 V dif/dt = 1000 A/μs	Note 1
Q <sub>rr</sub>	Reverse Recovery Charge	283		nC		
I <sub>rrm</sub>	Peak Reverse Recovery Current	15		A		

Note (1): When using SiC Body Diode the maximum recommended V<sub>GS</sub> = -5V

## Thermal Characteristics

Symbol	Parameter	Typ.	Max.	Unit	Test Conditions	Note
R <sub>θJC</sub>	Thermal Resistance from Junction to Case	0.33	0.45	°C/W		Fig. 21
R <sub>θJA</sub>	Thermal Resistance from Junction to Ambient		40			

## Typical Performance

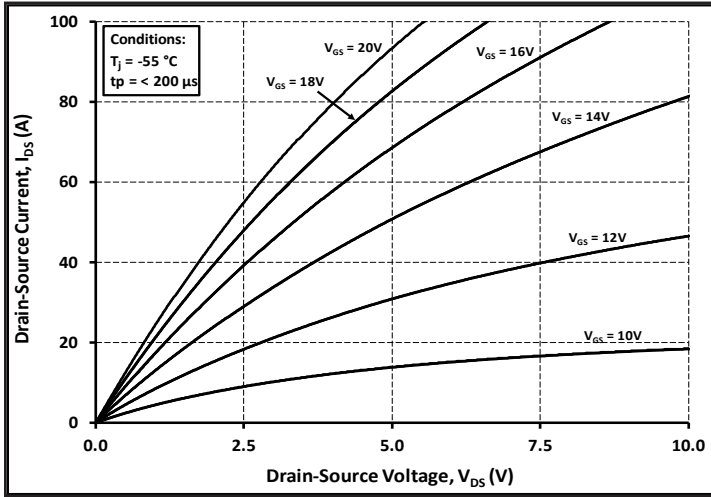

Figure 1. Output Characteristics  $T_J = -55\text{ }^\circ\text{C}$

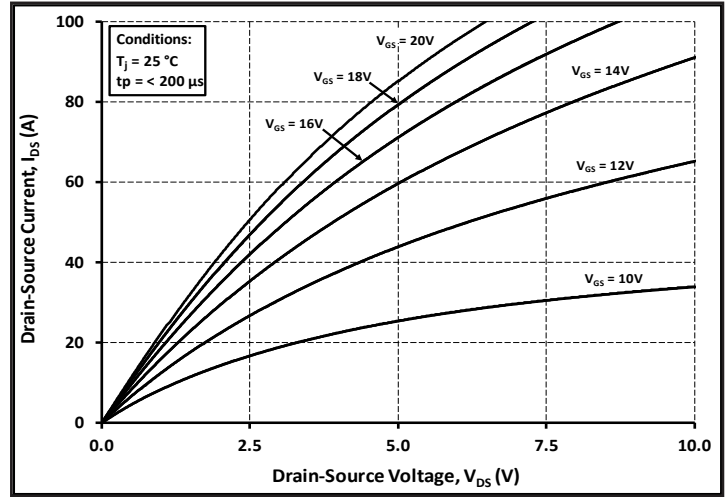

Figure 2. Output Characteristics  $T_J = 25\text{ }^\circ\text{C}$

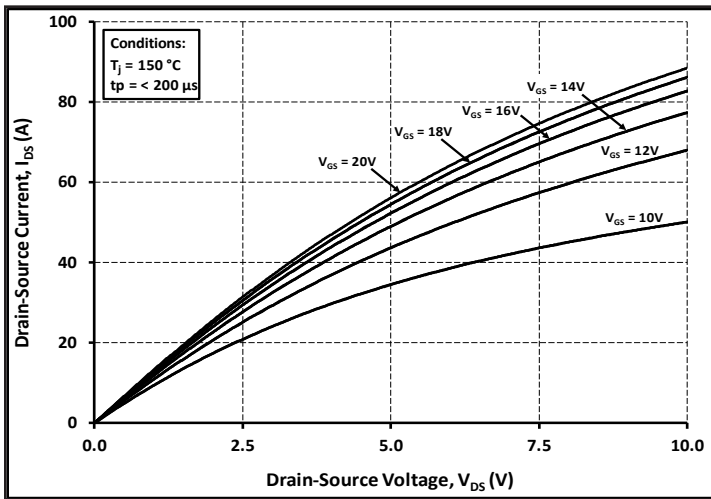

Figure 3. Output Characteristics  $T_J = 150\text{ }^\circ\text{C}$

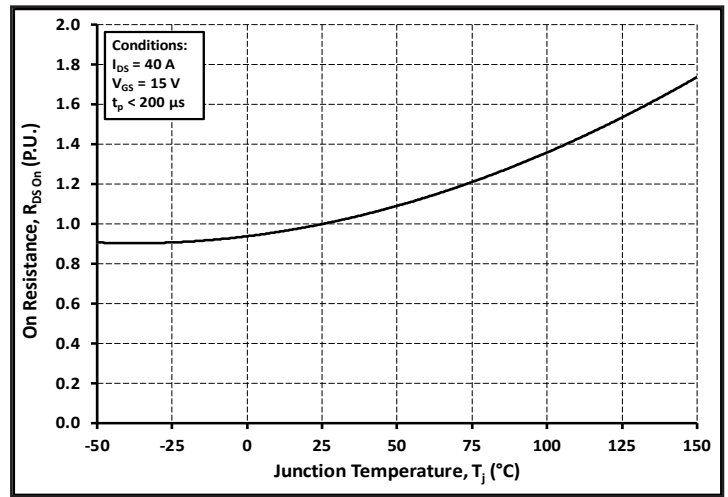

Figure 4. Normalized On-Resistance vs. Temperature

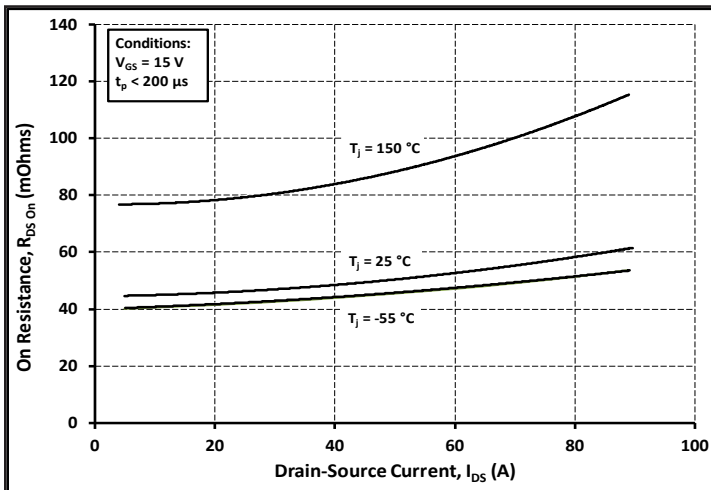

Figure 5. On-Resistance vs. Drain Current For Various Temperatures

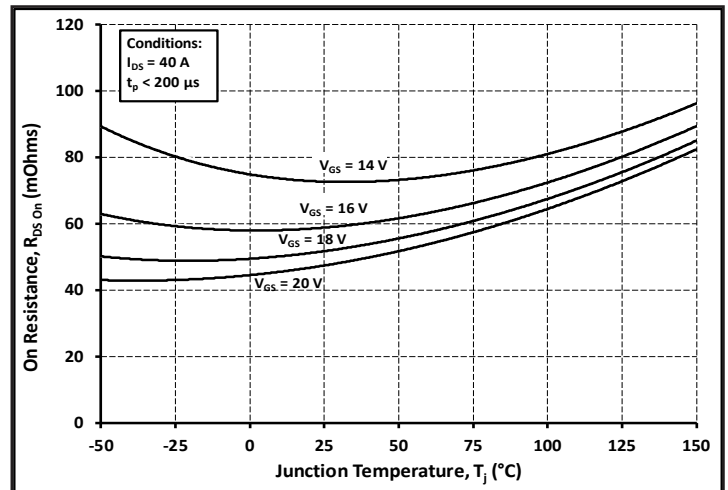

Figure 6. On-Resistance vs. Temperature For Various Gate Voltage

## Typical Performance

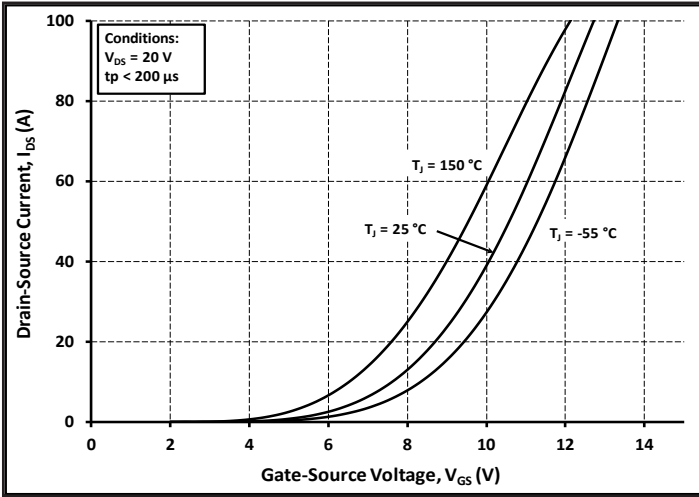

Figure 7. Transfer Characteristic for Various Junction Temperatures

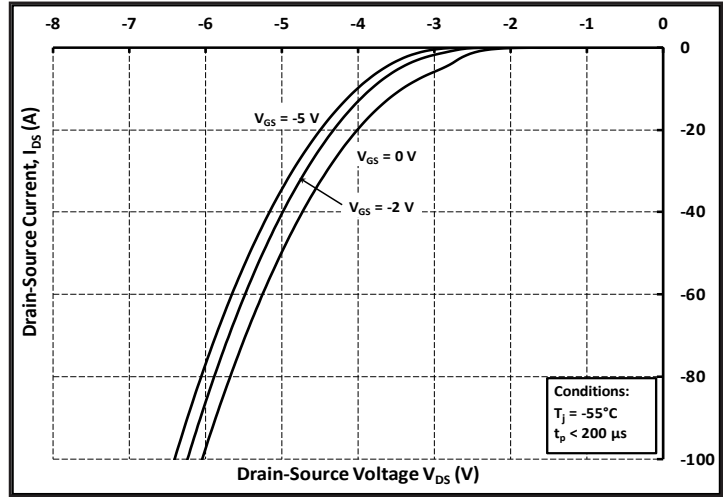

Figure 8. Body Diode Characteristic at  $-55\text{ }^\circ\text{C}$

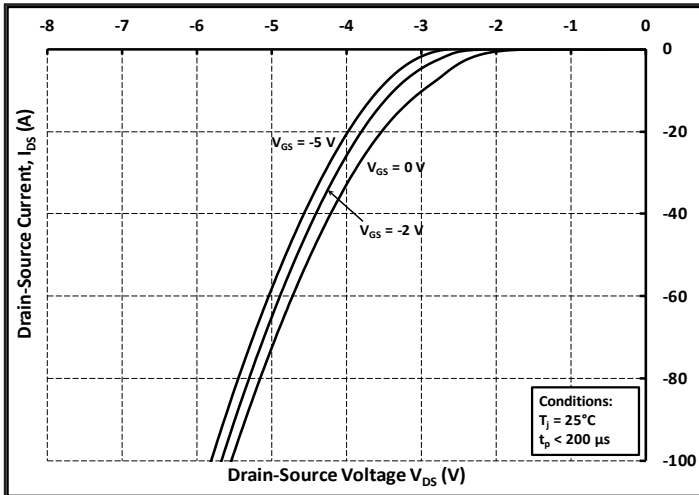

Figure 9. Body Diode Characteristic at  $25\text{ }^\circ\text{C}$

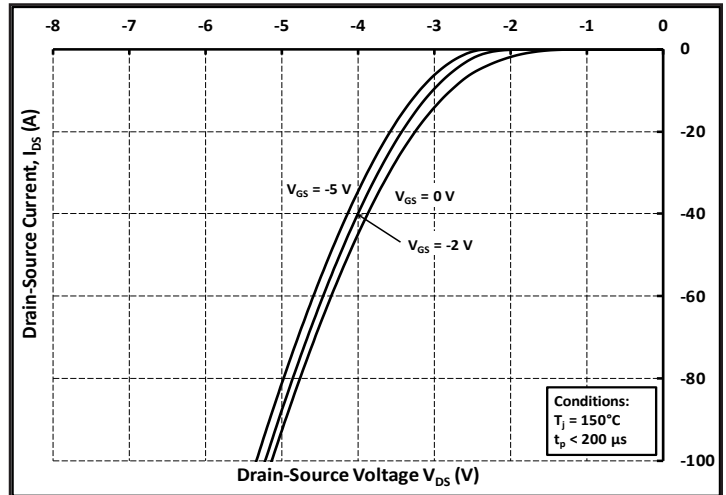

Figure 10. Body Diode Characteristic at  $150\text{ }^\circ\text{C}$

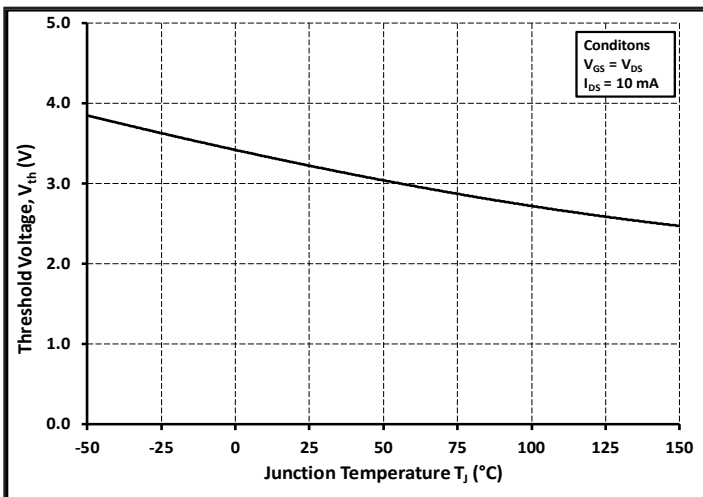

Figure 11. Threshold Voltage vs. Temperature

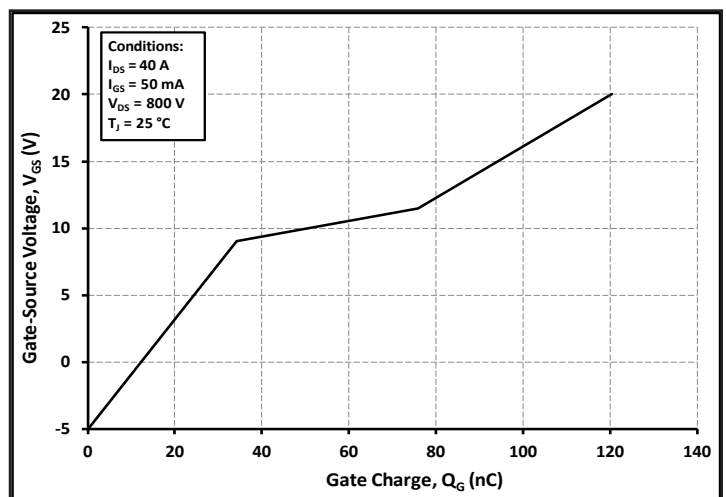

Figure 12. Gate Charge Characteristics

## Typical Performance

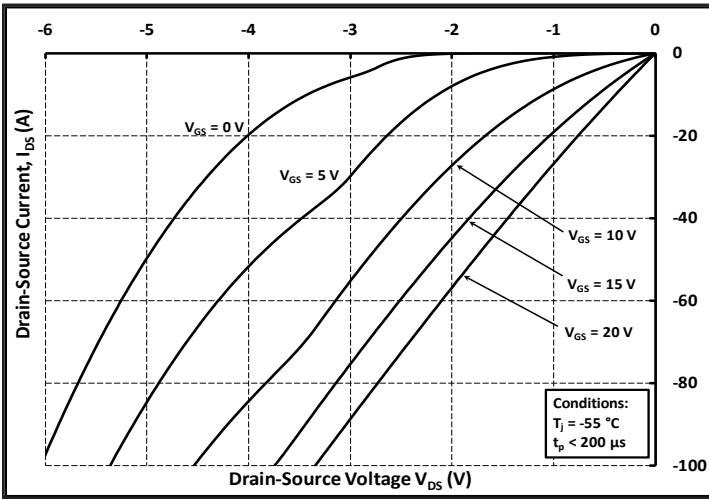

Figure 13. 3rd Quadrant Characteristic at  $-55\text{ }^\circ\text{C}$

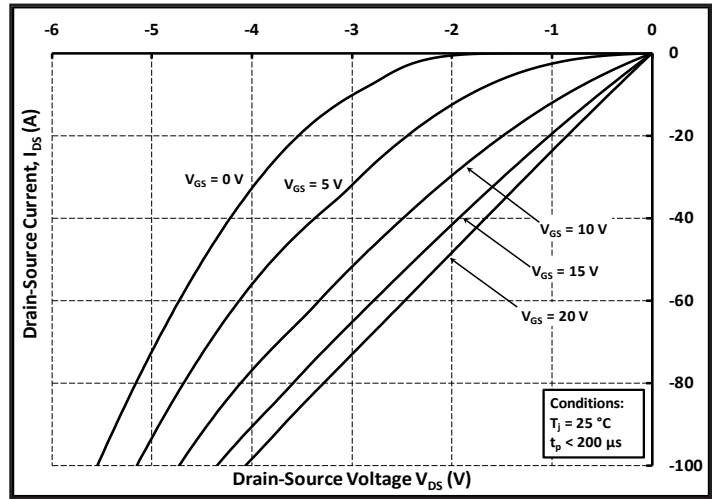

Figure 14. 3rd Quadrant Characteristic at  $25\text{ }^\circ\text{C}$

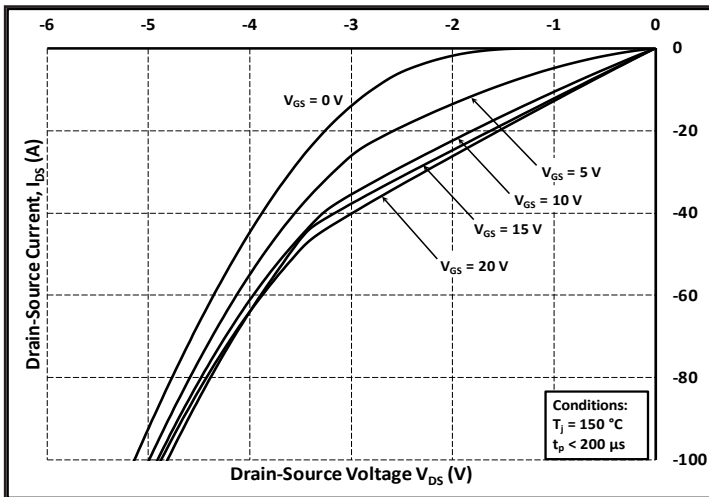

Figure 15. 3rd Quadrant Characteristic at  $150\text{ }^\circ\text{C}$

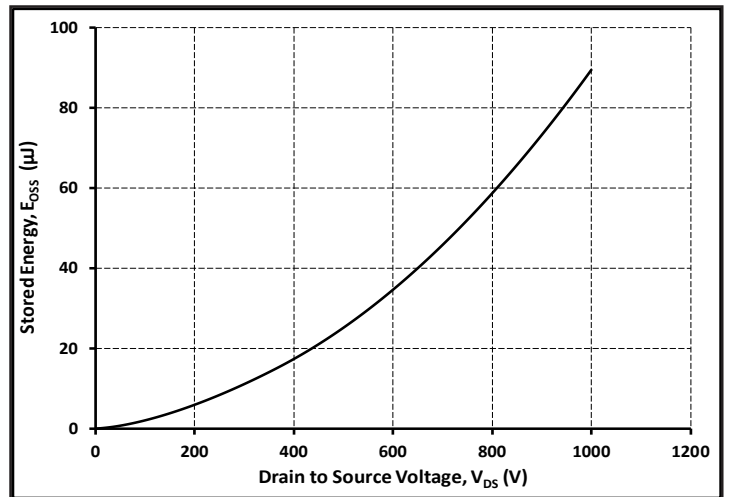

Figure 16. Output Capacitor Stored Energy

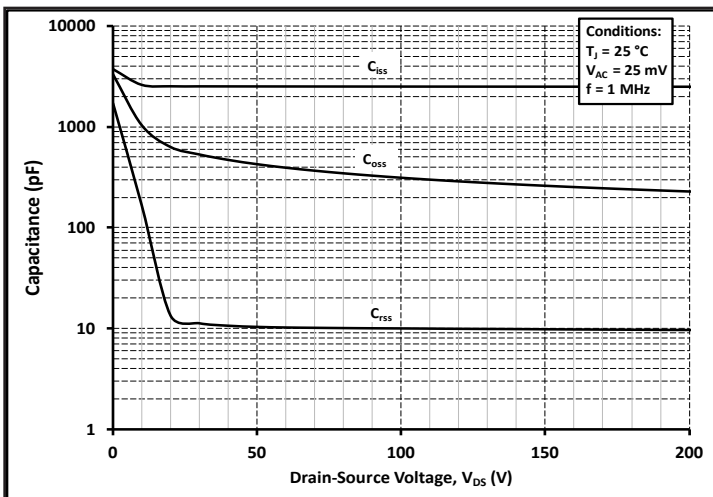

Figure 17. Capacitances vs. Drain-Source Voltage (0-200 V)

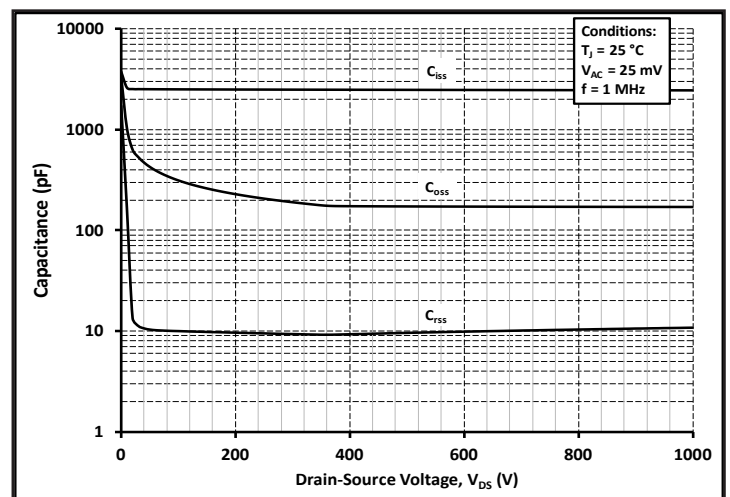

Figure 18. Capacitances vs. Drain-Source Voltage (0-1000 V)

## Typical Performance

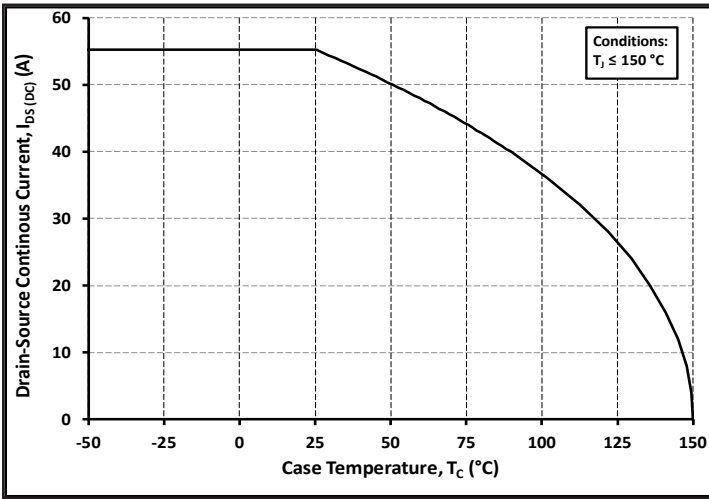

Figure 19. Continuous Drain Current Derating vs. Case Temperature

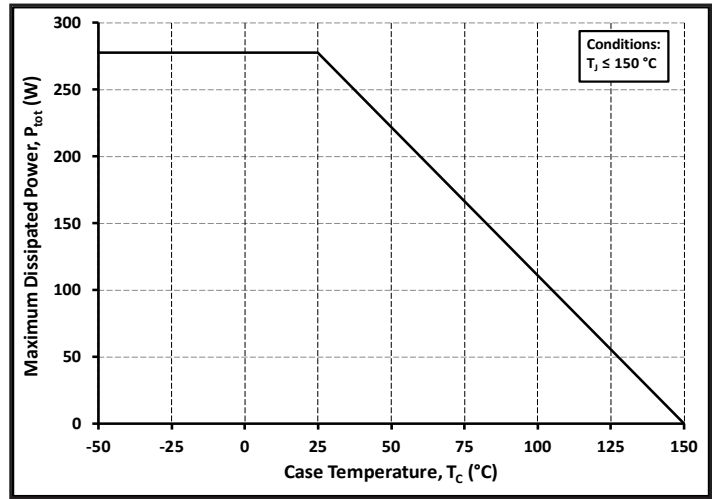

Figure 20. Maximum Power Dissipation Derating vs. Case Temperature

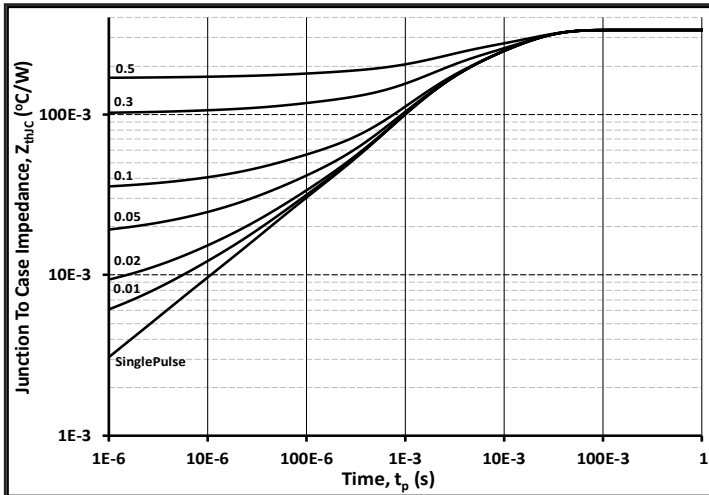

Figure 21. Transient Thermal Impedance (Junction - Case)

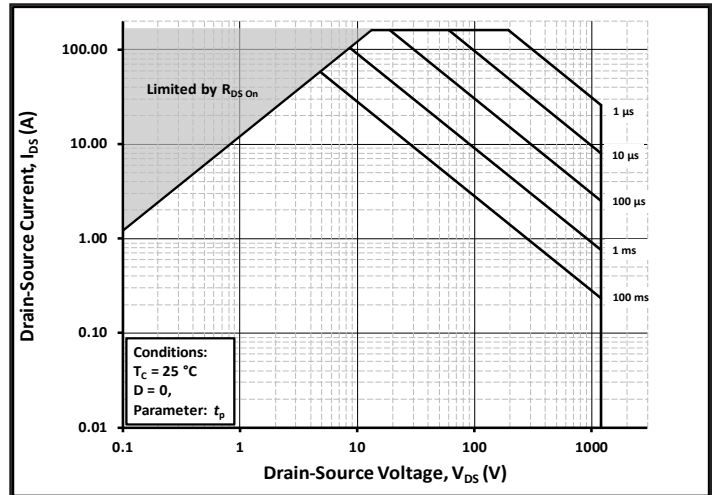

Figure 22. Safe Operating Area

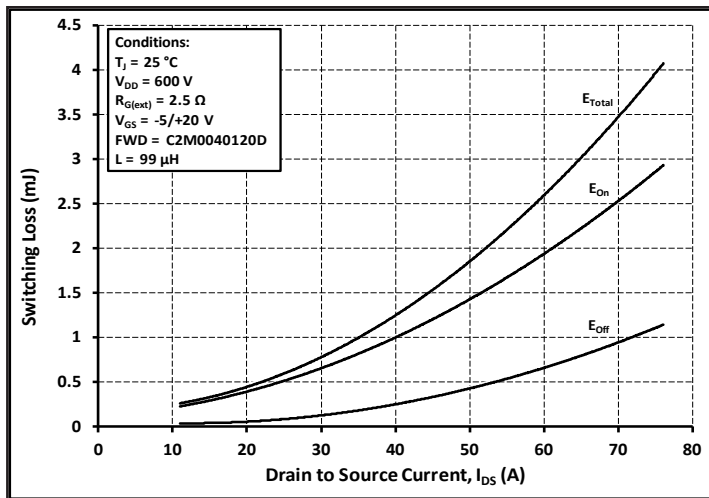

Figure 23. Clamped Inductive Switching Energy vs. Drain Current ( $V_{DD} = 600V$ )

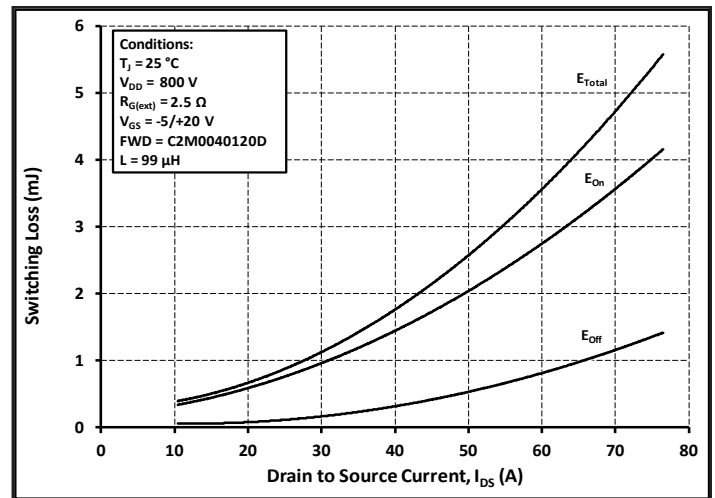

Figure 24. Clamped Inductive Switching Energy vs. Drain Current ( $V_{DD} = 800V$ )

## Typical Performance

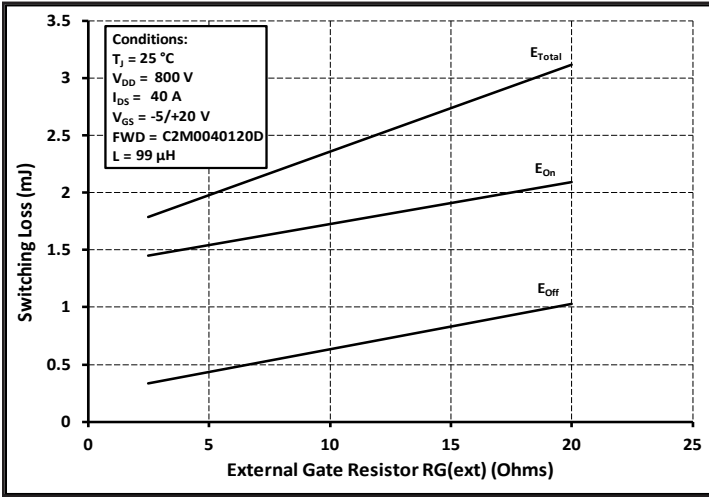

Figure 25. Clamped Inductive Switching Energy vs.  $R_{G(ext)}$

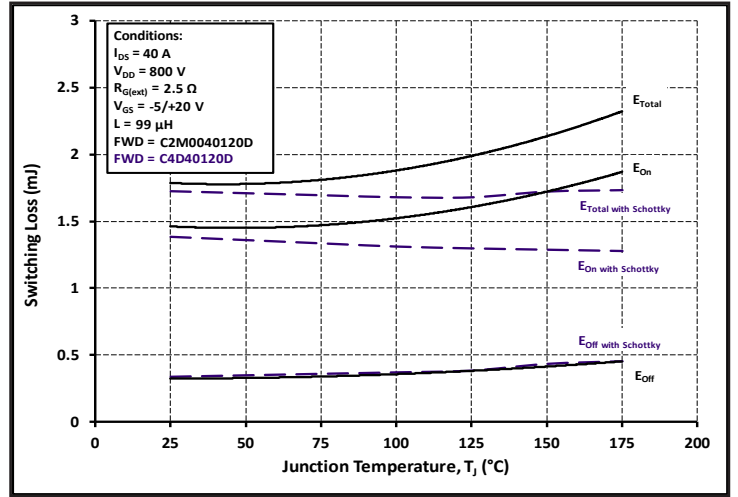

Figure 26. Clamped Inductive Switching Energy vs. Temperature

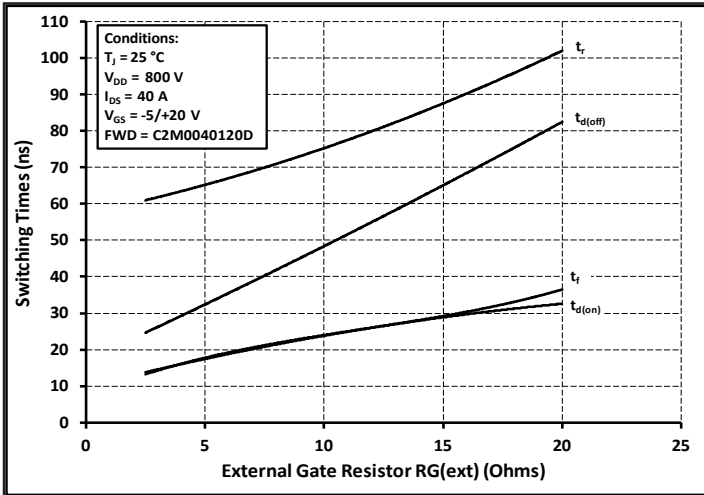

Figure 27. Switching Times vs.  $R_{G(ext)}$

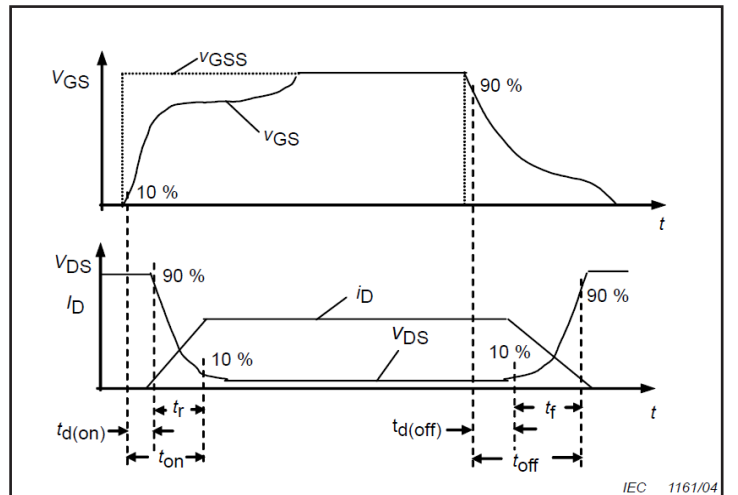

Figure 28. Switching Times Definition



## Test Circuit Schematic

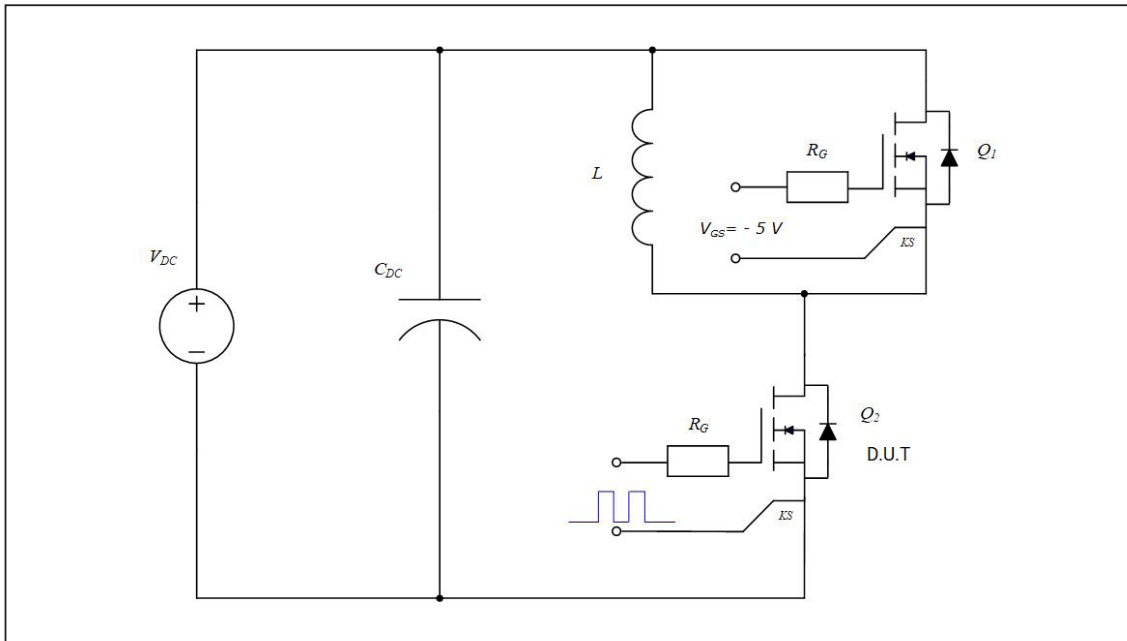

Figure 29. Clamped Inductive Switching  
Waveform Test Circuit

## ESD Ratings

ESD Test	Resulting Classification
ESD-HBM	3A (4000V - 8000V)
ESD-CDM	C3 ( $\geq 1000V$ )

## Package Dimensions

Package TO-247-3

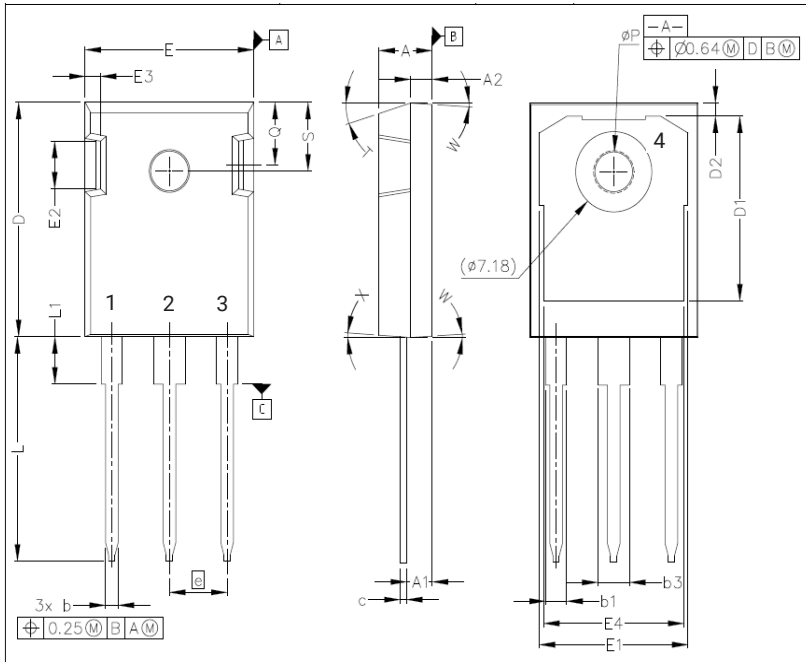

SYM	MILLIMETERS		INCHES	
	MIN	MAX	MIN	MAX
A	4.83	5.21	.190	.205
A1	2.29	2.54	.090	.100
A2	1.91	2.16	.075	.085
b	1.07	1.33	.042	.052
b1	1.91	2.41	.075	.095
b3	2.87	3.38	.113	.133
c	0.55	0.68	.022	.027
D	20.80	21.10	.819	.831
D1	16.25	17.65	.640	.695
D2	0.95	1.25	.037	.049
E	15.75	16.13	.620	.635
E1	13.10	14.15	.516	.557
E2	3.68	5.10	.145	.201
E3	1.00	1.90	.039	.075
E4	12.38	13.43	.487	.529
e	5.44 BSC		.214 BSC	
N	3		3	
L	19.81	20.32	.780	.800
L1	4.10	4.40	.161	.173
φP	3.51	3.65	.138	.144
Q	5.49	6.00	.216	.236
S	6.04	6.30	.238	.248
T	17.5° REF.			
W	3.5° REF.			
X	4° REF.			

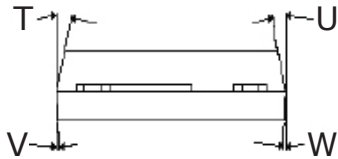

Pinout Information:

- Pin 1 = Gate
- Pin 2, 4 = Drain
- Pin 3 = Source

## Recommended Solder Pad Layout

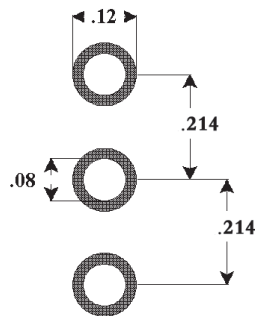

TO-247-3



## Notes

---

- **RoHS Compliance**  
The levels of RoHS restricted materials in this product are below the maximum concentration values (also referred to as the threshold limits) permitted for such substances, or are used in an exempted application, in accordance with EU Directive 2011/65/EC (RoHS2), as implemented January 2, 2013. RoHS Declarations for this product can be obtained from your Cree representative or from the Product Documentation sections of [www.cree.com](http://www.cree.com).
- **REACH Compliance**  
REACH substances of high concern (SVHCs) information is available for this product. Since the European Chemical Agency (ECHA) has published notice of their intent to frequently revise the SVHC listing for the foreseeable future, please contact a Cree representative to insure you get the most up-to-date REACH SVHC Declaration. REACH banned substance information (REACH Article 67) is also available upon request.
- This product has not been designed or tested for use in, and is not intended for use in, applications implanted into the human body nor in applications in which failure of the product could lead to death, personal injury or property damage, including but not limited to equipment used in the operation of nuclear facilities, life-support machines, cardiac defibrillators or similar emergency medical equipment, aircraft navigation or communication or control systems, air traffic control systems.

## Related Links

---

- **C2M PSPICE Models:** <http://wolfspeed.com/power/tools-and-support>
- **SiC MOSFET Isolated Gate Driver reference design:** <http://wolfspeed.com/power/tools-and-support>
- **SiC MOSFET Evaluation Board:** <http://wolfspeed.com/power/tools-and-support>