

		REVISIONS		
REV.	ECO. NO	DESCRIPTION	DATE	BY
L	3809	ADD KEY SLOT IN POSITION, KEY SLOT BETWEEN POSITIONS OPTION, OBSOLETE DWG 12896 (REPLACE WITH DWG 11051)	2/13/2018	JH
M	4133	ADD PIN A1, A2, B1, B2 NOTE, REMOVE KEY LOCATION TABLE (REPLACE WITH C13556, CHANGE S1013 TO S2425)	10/25/2019	JH
N	4340	ADD NOTE TO P/N CODING S81 FOR GREEN PBT W/O KEY & C14008 FOR BROWN PPS/BLACK PBT WITH MOLDED KEY, OBSOLETE DWG 13027, E. C. MMSD-S2167	3/31/2023	JH

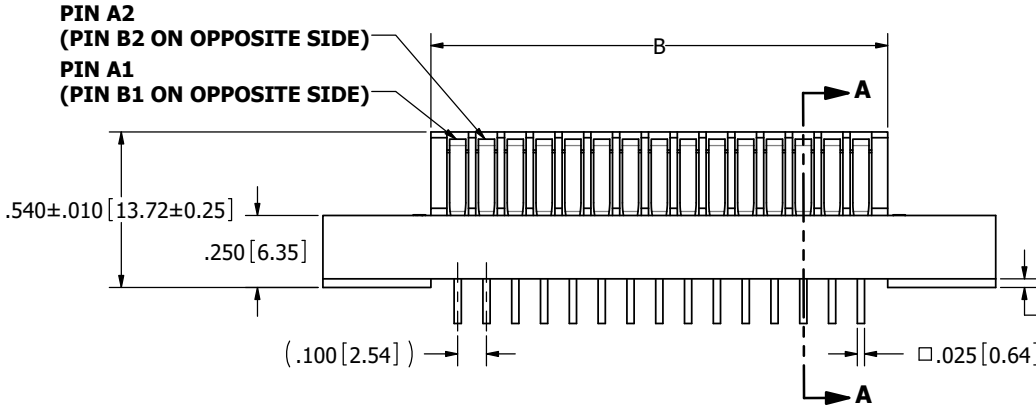
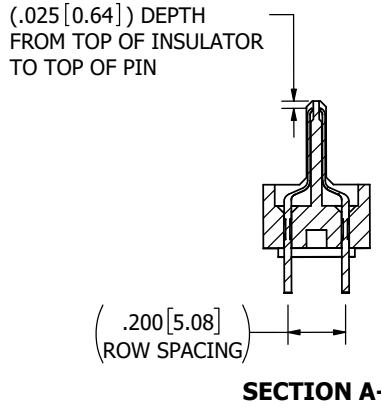
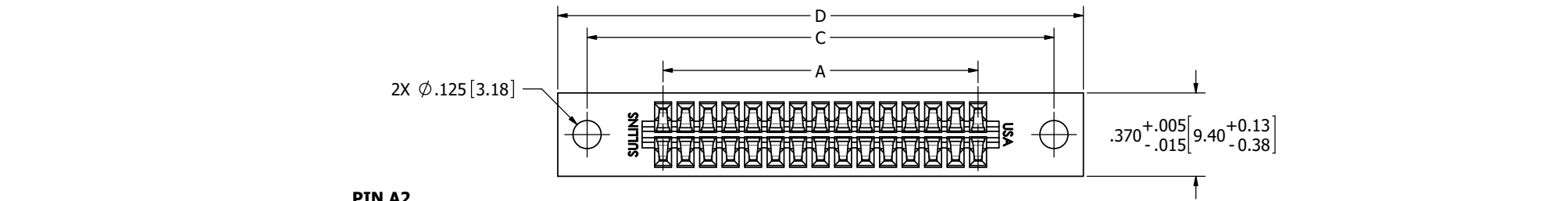

FITS EDGECARDS THAT ACCEPT .062 [1.57] PCB'S

MW = .125 ± .025 [3.18 ± 0.64]
 MS = .190 ± .025 [4.83 ± 0.64]
 MM = .560 ± .025 [14.22 ± 0.64]

C M D
 E C M D-S81
 G C M D-S2196

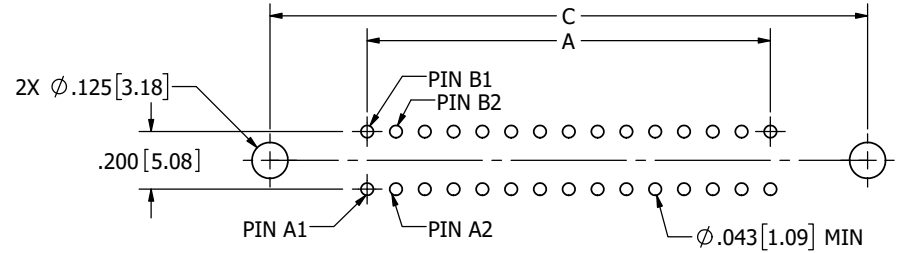

- NOTES:**
- INSULATOR MATERIAL: SEE PART NUMBER CODING
 - CONTACT MATERIAL: SEE PART NUMBER CODING
 - PLATING: SEE PART NUMBER CODING
 - OPERATING TEMPERATURE: SEE PART NUMBER CODING
 - PROCESSING TEMP: SEE PART NUMBER CODING
 - UL FLAMMABILITY RATING: 94V-0
 - OPERATING VOLTAGE: 700 VAC
 - CURRENT RATING: 3 AMP
 - CONTACT RESISTANCE: 30 MILLI OHMS MAX
 - INSULATION RESISTANCE: 5000 MEGA OHMS
 - CONNECTOR IDENTIFICATION: PART SHALL BE MARKED WITH A PART NUMBER AND LOT CODE
 - MODIFICATION: SEE PART NUMBER CODING



UNLESS OTHERWISE SPECIFIED:
 DIMENSIONS ARE IN INCHES (MM)

TOLERANCES:
 ANGULAR: ± 1°

DECIMALS
 .XX = ± .02 [5]
 .XXX = ± .005 [13]
 .XXXX = ± .0005 [013]

DRAWN	DATE	NAME		
	02/05/08	MNH		
<small>THE INFORMATION HEREIN CONTAINS PROPRIETARY INFORMATION OF SULLINS ELECTRONICS AND IS NOT TO BE REPRODUCED, USED OR DISCLOSED TO OTHERS FOR ANY PURPOSE EXCEPT AS SPECIFICALLY AUTHORIZED IN WRITING BY AN OFFICER OF SULLINS ELECTRONICS.</small>			TITLE MALE, EDGECARD, .100 CC	
PART NUMBER C M(MW,MS,MM)_(S81, S2196)			SCALE: 3:1	
SIZE	CAGE CODE	DWG. NO.	REV	
C	54453	C11051	N	
SHEET 1 OF 4				

CUSTOMER COPY

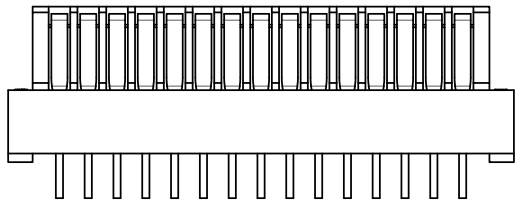
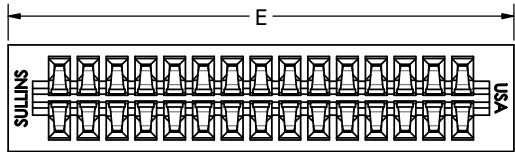

C M N
E C M N-S81
G C M N-S2196

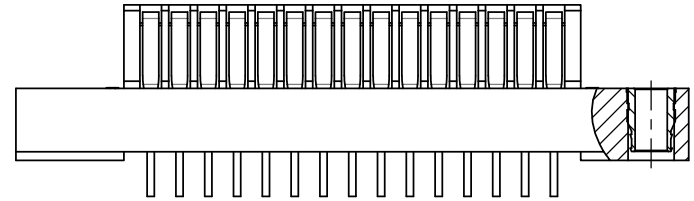
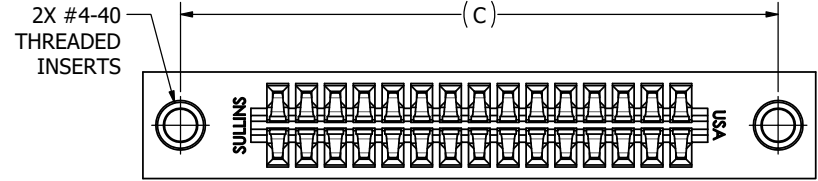

C M T
E C M T-S81
G C M T-S2196

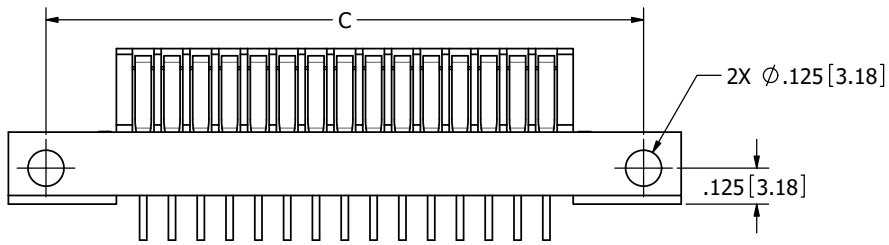
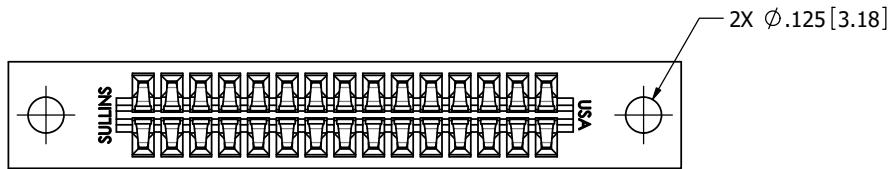

C M Z
E C M Z-S81
G C M Z-S2196

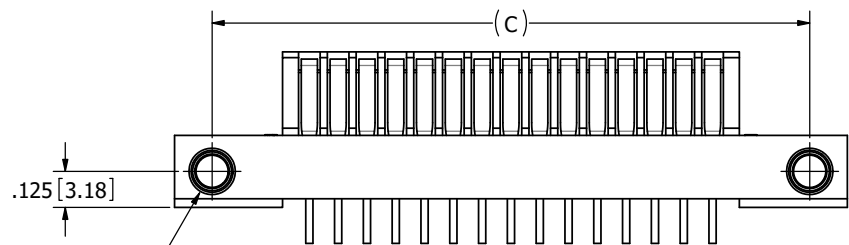
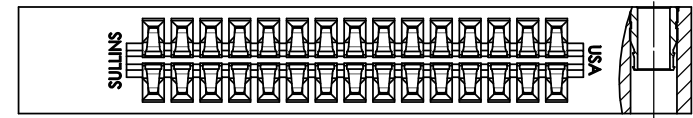

C M V
E C M V-S81
G C M V-S2196

CUSTOMER COPY



RoHS COMPLIANT

UNLESS OTHERWISE SPECIFIED:
DIMENSIONS ARE IN INCHES [MM]

TOLERANCES:
 ANGULAR: ± 1°
 DECIMALS
 .XX = ± .02 [5]
 .XXX = ± .005 [13]
 .XXXX = ± .0005 [013]

DRAWN	DATE	NAME
	02/05/08	MNH

THE INFORMATION HEREIN CONTAINS
 PROPRIETARY INFORMATION OF
 SULLINS ELECTRONICS AND IS NOT
 TO BE REPRODUCED, USED OR
 DISCLOSED TO OTHERS FOR ANY
 PURPOSE EXCEPT AS SPECIFICALLY
 AUTHORIZED IN WRITING BY AN
 OFFICER OF SULLINS ELECTRONICS.

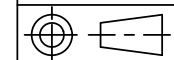

SULLINS CONNECTOR SOLUTIONS			
TITLE MALE, EDGECARD, .100 CC			
PART NUMBER C M(MW,MS,MM)-(S81, S2196)			
SIZE	CAGE CODE	DWG. NO.	REV
C	54453	C11051	N
SCALE: 3:1			SHEET 2 OF 4

PART NUMBER	NO. OF POS.	A±.008[0.20]		B±.008[0.20]		C±.010[0.25]		D±.020[0.51]		*E±.020[0.51]	
		IN	MM	IN	MM	IN	MM	IN	MM	IN	MM
C04M	4	0.300	7.62	0.486	12.34	0.975	24.77	1.236	31.39	0.656	16.66
C05M	5	0.400	10.16	0.586	14.88	1.075	27.31	1.336	33.93	0.756	19.20
C06M	6	0.500	12.70	0.686	17.42	1.175	29.85	1.436	36.47	0.856	21.74
C07M	7	0.600	15.24	0.786	19.96	1.275	32.39	1.536	39.01	0.956	24.28
C08M	8	0.700	17.78	0.886	22.50	1.375	34.93	1.636	41.55	1.056	26.82
C09M	9	0.800	20.32	0.986	25.04	1.475	37.47	1.736	44.09	1.156	29.36
C10M	10	0.900	22.86	1.086	27.58	1.575	40.01	1.836	46.63	1.256	31.90
C11M	11	1.000	25.40	1.186	30.12	1.675	42.55	1.936	49.17	1.356	34.44
C12M	12	1.100	27.94	1.286	32.66	1.775	45.09	2.036	51.71	1.456	36.98
C13M	13	1.200	30.48	1.386	35.20	1.875	47.63	2.136	54.25	1.556	39.52
C14M	14	1.300	33.02	1.486	37.74	1.975	50.17	2.236	56.79	1.656	42.06
C15M	15	1.400	35.56	1.586	40.28	2.075	52.71	2.336	59.33	1.756	44.60
C16M	16	1.500	38.10	1.686	42.82	2.175	55.25	2.436	61.87	1.856	47.14
C17M	17	1.600	40.64	1.786	45.36	2.275	57.79	2.536	64.41	1.956	49.68
C18M	18	1.700	43.18	1.886	47.90	2.375	60.33	2.636	66.95	2.056	52.22
C19M	19	1.800	45.72	1.986	50.44	2.475	62.87	2.736	69.49	2.156	54.76
C20M	20	1.900	48.26	2.086	52.98	2.575	65.41	2.836	72.03	2.256	57.30
C21M	21	2.000	50.80	2.186	55.52	2.675	67.95	2.936	74.57	2.356	59.84
C22M	22	2.100	53.34	2.286	58.06	2.775	70.49	3.036	77.11	2.456	62.38
C23M	23	2.200	55.88	2.386	60.60	2.875	73.03	3.136	79.65	2.556	64.92
C24M	24	2.300	58.42	2.486	63.14	2.975	75.57	3.236	82.19	2.656	67.46
C25M	25	2.400	60.96	2.586	65.68	3.075	78.11	3.336	84.73	2.756	70.00
C26M	26	2.500	63.50	2.686	68.22	3.175	80.65	3.436	87.27	2.856	72.54
C27M	27	2.600	66.04	2.786	70.76	3.275	83.19	3.536	89.81	2.956	75.08
C28M	28	2.700	68.58	2.886	73.30	3.375	85.73	3.636	92.35	3.056	77.62
C29M	29	2.800	71.12	2.986	75.84	3.475	88.27	3.736	94.89	3.156	80.16
C30M	30	2.900	73.66	3.086	78.38	3.575	90.81	3.836	97.43	3.256	82.70
C31M	31	3.000	76.20	3.186	80.92	3.675	93.35	3.936	99.97	3.356	85.24
C32M	32	3.100	78.74	3.286	83.46	3.775	95.89	4.036	102.51	3.456	87.78
C33M	33	3.200	81.28	3.386	86.00	3.875	98.43	4.136	105.05	3.556	90.32
C34M	34	3.300	83.82	3.486	88.54	3.975	100.97	4.236	107.59	3.656	92.86
C35M	35	3.400	86.36	3.586	91.08	4.075	103.51	4.336	110.13	3.756	95.40

PART NUMBER	NO. OF POS.	A±.008[0.20]		B±.008[0.20]		C±.010[0.25]		D±.020[0.51]		*E±.020[0.51]	
		IN	MM	IN	MM	IN	MM	IN	MM	IN	MM
C36M	36	3.500	88.90	3.686	93.62	4.175	106.05	4.436	112.67	3.856	97.94
C37M	37	3.600	91.44	3.786	96.16	4.275	108.59	4.536	115.21	3.956	100.48
C38M	38	3.700	93.98	3.886	98.70	4.375	111.13	4.636	117.75	4.056	103.02
C39M	39	3.800	96.52	3.986	101.24	4.475	113.67	4.736	120.29	4.156	105.56
C40M	40	3.900	99.06	4.086	103.78	4.575	116.21	4.836	122.83	4.256	108.10
C41M	41	4.000	101.60	4.186	106.32	4.675	118.75	4.936	125.37	4.356	110.64
C42M	42	4.100	104.14	4.286	108.86	4.775	121.29	5.036	127.91	4.456	113.18
C43M	43	4.200	106.68	4.386	111.40	4.875	123.83	5.136	130.45	4.556	115.72
C44M	44	4.300	109.22	4.486	113.94	4.975	126.37	5.236	132.99	4.656	118.26
C45M	45	4.400	111.76	4.586	116.48	5.075	128.91	5.336	135.53	4.756	120.80
C46M	46	4.500	114.30	4.686	119.02	5.175	131.45	5.436	138.07	4.856	123.34
C47M	47	4.600	116.84	4.786	121.56	5.275	133.99	5.536	140.61	4.956	125.88
C48M	48	4.700	119.38	4.886	124.10	5.375	136.53	5.636	143.15	5.056	128.42
C49M	49	4.800	121.92	4.986	126.64	5.475	139.07	5.736	145.69	5.156	130.96
C50M	50	4.900	124.46	5.086	129.18	5.575	141.61	5.836	148.23	5.256	133.50
C51M	51	5.000	127.00	5.186	131.72	5.675	144.15	5.936	150.77	5.356	136.04
C52M	52	5.100	129.54	5.286	134.26	5.775	146.69	6.036	153.31	5.456	138.58
C53M	53	5.200	132.08	5.386	136.80	5.875	149.23	6.136	155.85	5.556	141.12
C54M	54	5.300	134.62	5.486	139.34	5.975	151.77	6.236	158.39	5.656	143.66
C55M	55	5.400	137.16	5.586	141.88	6.075	154.31	6.336	160.93	5.756	146.20
C56M	56	5.500	139.70	5.686	144.42					5.856	148.74
C57M	57	5.600	142.24	5.786	146.96					5.956	151.28
C58M	58	5.700	144.78	5.886	149.50					6.056	153.82
C59M	59	5.800	147.32	5.986	152.04					6.156	156.36
C60M	60	5.900	149.86	6.086	154.58					6.256	158.90

*'N' MTG ONLY

PART NUMBER CODING

C **M** **S**

MATERIAL (INSULATOR/CONTACT)

- E = BLUE PBT/PHOSPHOR BRONZE**
OPERATING TEMP: -65°C TO +125°C
PROCESSING TEMP: WAVE/MANUAL SOLDERING ONLY
- G = BLACK PA9T/PHOSPHOR BRONZE****
OPERATING TEMP: -65°C TO +150°C
PROCESSING TEMP: 260°C MAX FOR 20 SECONDS
- R = BLACK PPS/PHOSPHOR BRONZE****
OPERATING TEMP: -65°C TO +150°C ('B' OR 'C' PLATING)
-65°C TO +200°C ('M' PLATING ONLY)
PROCESSING TEMP: 260°C MAX FOR 20 SECONDS
- Q = TAN PEEK/PHOSPHOR BRONZE****
OPERATING TEMP: -65°C TO +250°C
PROCESSING TEMP: 260°C MAX FOR 20 SECONDS
AVAILABLE IN OVERALL GOLD ('M' PLATING ONLY)

PLATING

- ALL PLATINGS HAVE .000050" NICKEL UNDERPLATE**
- CONTACT SURFACE TERMINATION
- B = .000010" GOLD .000100" PURE TIN, MATTE
- C = .000030" GOLD .000100" PURE TIN, MATTE
- M = .000030" GOLD .000010" GOLD OVERALL
- **OR EQUIVALENT

MODIFICATION

- OMIT FOR STANDARD COLOR INSULATOR WITHOUT MOLDED KEY, EX: 'EBC22MMW'
- S81 = GREEN PBT WITHOUT MOLDED KEY (FOR MATERIAL CODE 'E' ONLY)
- S2196 = WHITE PA9T WITHOUT MOLDED KEY (FOR MATERIAL CODE 'G' ONLY)
- SEE DRAWING C13556 FOR S#, 'G' & 'H' DIMENSIONS FOR STANDARD COLOR WITH MOLDED KEY
- SEE DRAWING C14008 FOR S#, 'G' & 'H' DIMENSIONS FOR BROWN PPS OR BLACK PBT WITH MOLDED KEY

MOUNTING STYLE

- D = FLUSH, .125" DIA. CLEARANCE HOLES
- N = NO MOUNTING EARS
- Z = FLUSH, .125" DIA. SIDE MOUNTING
- T = FLUSH, #4-40 THREADED INSERT
- V = FLUSH, SIDE MOUNT #4-40 THREADED INSERT

TERMINATION

- MW = DIP SOLDER, .125[3.18] TAIL LENGTH
- MS = DIP SOLDER, .190[4.93] TAIL LENGTH
- MM = WIRE WRAP, .560[14.22] TAIL LENGTH

NUMBER OF POSITIONS
(CONTACTS PER ROW)



RoHS COMPLIANT

CUSTOMER COPY

UNLESS OTHERWISE SPECIFIED, DIMENSIONS ARE IN INCHES (MM)	DRAWN	DATE	NAME	
		02/05/08	MNH	
TOLERANCES:				<small>THE INFORMATION HEREIN CONTAINS PROPRIETARY INFORMATION OF SULLINS ELECTRONICS AND IS NOT TO BE REPRODUCED, USED OR DISCLOSED TO OTHERS FOR ANY PURPOSE EXCEPT AS SPECIFICALLY AUTHORIZED IN WRITING BY AN OFFICER OF SULLINS ELECTRONICS.</small>
ANGULAR: ± 1°				
DECIMALS				
.XX = ± .02 [5] .XXX = ± .005 [13] .XXXX = ± .0005 [013]				
TITLE				MALE, EDGE CARD, .100 CC
PART NUMBER				C M(MW,MS,MM)_(S81, S2196)
SIZE	CAGE CODE	DWG. NO.	REV	
C	54453	C11051	N	
SCALE: 3:1				SHEET 3 OF 4

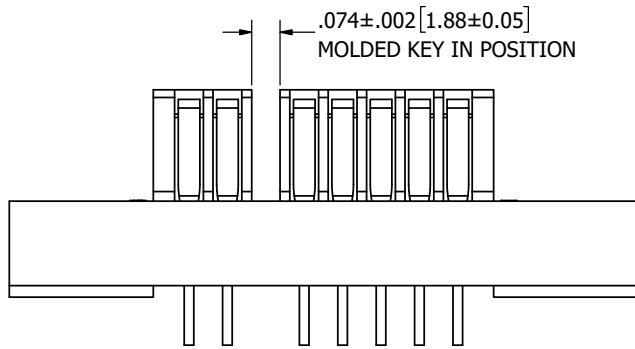
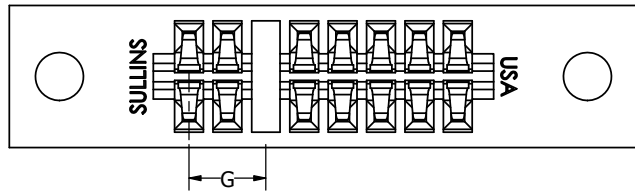

('D' MOUNTING AS SHOWN FOR EXAMPLE)

MATING SULLINS PRODUCT SERIES:

1. STD LOW PROFILE FEMALE CONNECTORS WITH MOLDED KEY IN POSITION
2. STD HIGH PROFILE FEMALE CONNECTORS WITH MOLDED KEY IN POSITION

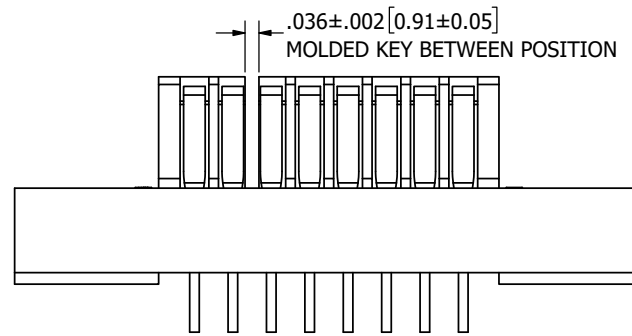
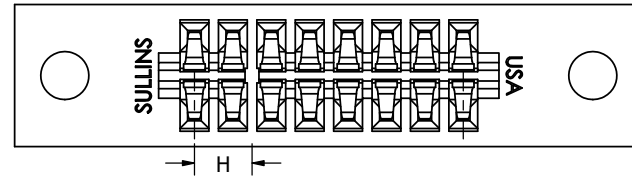

('D' MOUNTING AS SHOWN FOR EXAMPLE)

MATING SULLINS PRODUCT SERIES:

1. STD LOW PROFILE FEMALE CONNECTORS WITH MOLDED KEY BETWEEN POSITIONS, OR WITH IN-BETWEEN CONTACT KEY (SULLINS P/N: PLA-K1)
2. HIGH PROFILE FEMALE CONNECTORS WITH MOLDED KEY .030" WIDE BETWEEN POSITIONS (CONSULT FACTORY FOR PART NUMBER)

CUSTOMER COPY



RoHS COMPLIANT

UNLESS OTHERWISE SPECIFIED:
DIMENSIONS ARE IN INCHES (MM)

TOLERANCES:
ANGULAR: ± 1°
DECIMALS
.XX = ± .02 [.5]
.XXX = ± .005 [.13]
.XXXX = ± .0005 [.013]

DRAWN	DATE	NAME
	02/05/08	MNH

THE INFORMATION HEREIN CONTAINS PROPRIETARY INFORMATION OF SULLINS ELECTRONICS AND IS NOT TO BE REPRODUCED, USED OR DISCLOSED TO OTHERS FOR ANY PURPOSE EXCEPT AS SPECIFICALLY AUTHORIZED IN WRITING BY AN OFFICER OF SULLINS ELECTRONICS.

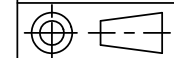

TITLE MALE, EDGECARD, .100 CC			
PART NUMBER C M(MW,MS,MM)_(S81, S2196)			
SIZE	CAGE CODE	DWG. NO.	REV
C	54453	C11051	N
SCALE: 3:1		SHEET 4 OF 4	