



Bridgelux® Gen 7 Vero® 18 Array

Product Data Sheet DSg2



Introduction

Vero® Series



Vero® Series is a revolutionary advancement in chip on board (COB) light source technology and innovation. Vero LED light sources simplify luminaire design and manufacturing processes. Vero Chip on Board (COB) LED arrays are available in four LES configurations, engineered to enable new degrees of flexibility and reliability over a broad range of electrical currents. Vero arrays deliver increased lumen density to enable improved beam control and precision lighting with 2 and 3 SDCM color control standard for clean and consistent uniform lighting.

Vero products include an onboard connector port that enables a solder-free electrical interconnect, and simple mounting features for plug-and-play installation.

Bridgelux Décor Series™ is our state-of-the-art color line designed specifically for premium applications, producing unmatched LED light quality with brilliant color-rendering options and pleasing lighting palettes. Bridgelux Décor Series color points are available on Vero® SE Series, Vero® Series, V Series™ and V Series™ HD.

Décor Series™ Class A is based on human response testing, providing color points with a combined GAI and CRI metric.

Décor Series™ Ultra products provide a high CRI of 97 and typical R9 value of 98, which emphasizes the reds and color tones to which the human eye is most receptive - perfect for the most luxurious retail shops and world renowned museums. Décor Series Ultra is designed as a replacement for halogen lamps.

Décor Series™ Food products offer color points developed to address the unique requirements of the food, grocery, and restaurant industries. Highlighting the distinctive colors and nuanced patterns found in meats and breads, the Décor Series Food products are a must have for any butcher counter or bakery.

Décor Series™ Entertainment products provide color points developed specifically for the healthcare and entertainment industries. The 5600K cool white color point combined with a CRI of 90 or 97 provides the bright white required by these industries.

Décor Series™ Street and Landmark is designed to be a direct replacement for high pressure sodium lamps.

Décor Series™ Showcase is the optimal solution for replacing ceramic metal halide lamps, incorporating the same pure white light with enhanced spectrum coverage and higher efficacy.

Features

- Efficacy of 170 lm/W typical for 3000K 80 CRI
- Lumen output performance ranges from 1,455 to 13,600 lumens
- Broad range of CCT options from 1750K to 6500K
- CRI options include minimum 65, 70, 80, 90, 95 and Class A
- Reliable operation at up to 2X nominal drive current
- Radial die pattern and improved lumen density
- Thermally isolated solder pads
- Onboard connector port
- Top side part number markings
- V_r bin code backside marking

Benefits

- Broad application coverage for interior and exterior lighting
- Flexibility for application driven lighting design requirements
- High quality true color reproduction
- Uniform consistent white light
- Flexibility in design optimization
- Enhanced ease of use and assembly
- Solderless connectivity enables plug & play installation and field upgradability
- Improved inventory management and quality control



Contents

Product Feature Map	2
Product Nomenclature	2
Product Selection Guide	3
European Product Registry for Energy Labeling	10
Performance at Commonly Used Drive Currents	13
Electrical Characteristics	23
Eye Safety	24
Absolute Maximum Ratings	25
Performance Curves	26
Typical Radiation Pattern	30
Typical Color Spectrum	31
Mechanical Dimensions	32
Color Binning Information	33
Packaging and Labeling	34
Design Resources	36
Precautions	36
Disclaimers	36
About Bridgelux	37

Product Feature Map

Vero 18 is the second largest form factor in the Vero family of next generation solid state light sources. In addition to delivering the performance and light quality required for many lighting applications, Vero incorporates

several features to simplify the design integration and manufacturing process, accelerate time to market and reduce system costs. Please visit www.bridgelux.com for more information on the Vero Series family of products.

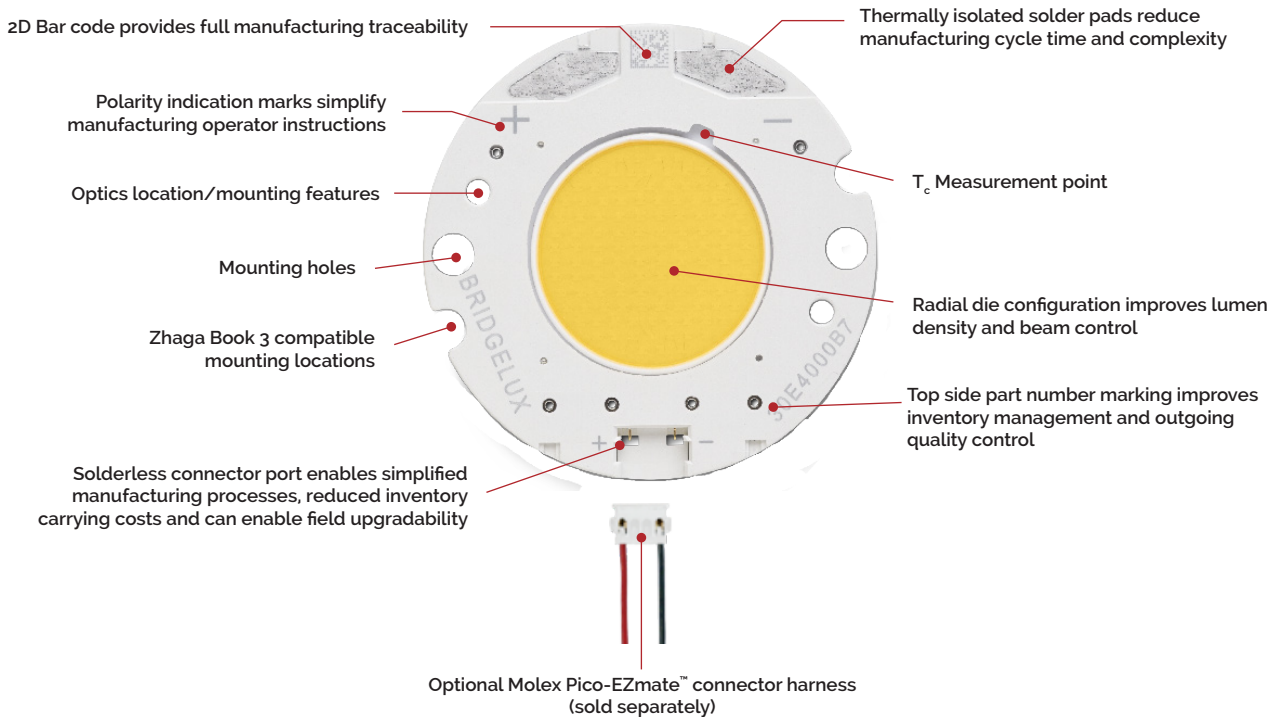

Product Nomenclature

The part number designation for Bridgelux Vero LED arrays is explained as follows:

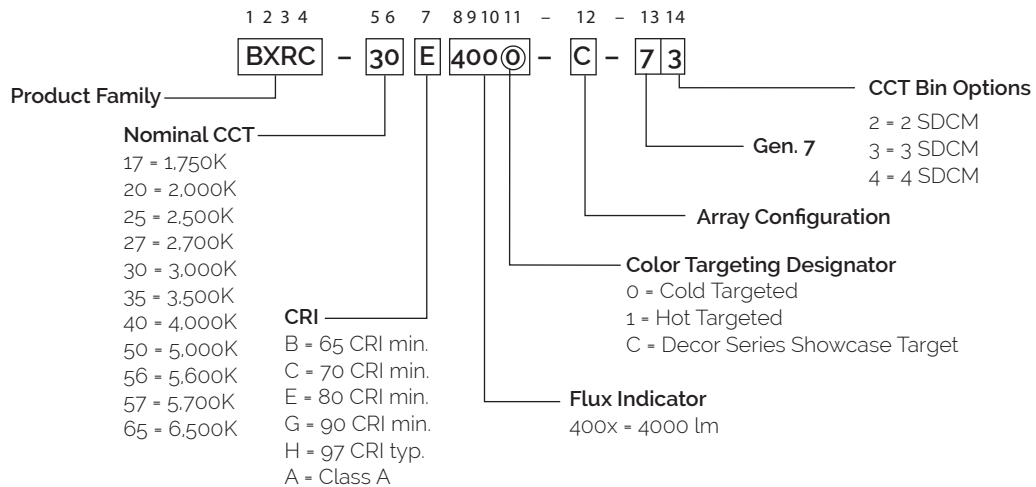

Product Selection Guide

The following product configurations are available:

Table 1: Selection Guide, Pulsed Measurement Data ($T_j = T_c = 25^\circ\text{C}$)

Part Number	Nominal CCT ¹ (K)	CRI ²	Nominal Drive Current ³ (mA)	Typical Pulsed Flux ^{4,5,6} $T_c = 25^\circ\text{C}$ (lm)	Minimum Pulsed Flux ^{6,7} $T_c = 25^\circ\text{C}$ (lm)	Typical V_f (V)	Typical Power (W)	Typical Efficacy (lm/W)
BXRC-17E4000-B-7x	1750	80	900	2881	2593	34.8	31.3	92
BXRC-17E4000-C-7x	1750	80	1170	3624	3261	34.8	40.7	89
BXRC-17E4000-D-7x	1750	80	1050	2710	2439	29.0	30.5	89
BXRC-20B4001-C-7x	2000	65	1170	6392	5753	34.8	40.7	157
BXRC-20B4001-D-7x	2000	65	1050	4781	4303	29.0	30.5	157
BXRC-25E4000-B-7x	2500	80	900	4792	4313	34.8	31.3	153
BXRC-25E4000-C-7x	2500	80	1170	6230	5607	34.8	40.7	153
BXRC-25E4000-D-7x	2500	80	1050	4659	4193	29.0	30.5	153
BXRC-27E4000-B-7x	2700	80	900	5011	4510	34.8	31.3	160
BXRC-27E4000-C-7x	2700	80	1170	6515	5863	34.8	40.7	160
BXRC-27E4000-D-7x	2700	80	1050	4872	4385	29.0	30.5	160
BXRC-27G40H0-B-7x	2700	90	900	4291	3862	34.8	31.3	137
BXRC-27G40H0-C-7x	2700	90	1170	5578	5020	34.8	40.7	137
BXRC-27G40H0-D-7x	2700	90	1050	4172	3754	29.0	30.5	137
BXRC-27G4000-B-7x	2700	90	900	4134	3721	34.8	31.3	132
BXRC-27G4000-C-7x	2700	90	1170	5375	4837	34.8	40.7	132
BXRC-27G4000-D-7x	2700	90	1050	4019	3617	29.0	30.5	132
BXRC-27H4000-B-7x	2700	97	900	3664	3298	34.8	31.3	117
BXRC-27H4000-C-7x	2700	97	1170	4764	4287	34.8	40.7	117
BXRC-27H4000-D-7x	2700	97	1050	3563	3206	29.0	30.5	117
BXRC-30C4001-B-7x	3000	70	900	5575	5017	34.8	31.3	178
BXRC-30C4001-C-7x	3000	70	1170	7247	6523	34.8	40.7	178
BXRC-30C4001-D-7x	3000	70	1050	5420	4878	29.0	30.5	178
BXRC-30E4000-B-7x	3000	80	900	5324	4792	34.8	31.3	170
BXRC-30E4000-C-7x	3000	80	1170	6922	6230	34.8	40.7	170
BXRC-30E4000-D-7x	3000	80	1050	5177	4659	29.0	30.5	170
BXRC-30G40H0-B-7x	3000	90	900	4322	3890	34.8	31.3	138
BXRC-30G40H0-C-7x	3000	90	1170	5619	5057	34.8	40.7	138
BXRC-30G40H0-D-7x	3000	90	1050	4202	3782	29.0	30.5	138
BXRC-30G4000-B-7x	3000	90	900	4510	4059	34.8	31.3	144
BXRC-30G4000-C-7x	3000	90	1170	5863	5277	34.8	40.7	144
BXRC-30G4000-D-7x	3000	90	1050	4385	3946	29.0	30.5	144
BXRC-30G400C-B-7x	3000	90	900	4166	3749	34.8	31.3	133
BXRC-30G400C-D-7x	3000	90	1050	4050	3645	29.0	30.5	133

Notes for Table 1:

- Nominal CCT as defined by ANSI C78.377-2011. Products with a CCT of 5000K-6500K are hot targeted to $T_c = 85^\circ\text{C}$.
- CRI values are typical for Decor Series Ultra, Decor Series Street and Landmark and Decor Series Class A products. CRI values are minimums for all other products. Minimum Rg value for 80 CRI products is 0, the minimum Rg value for 90 CRI products is 50, the minimum Rg value for 97 CRI products is 93. Bridgelux maintains a ± 3 tolerance on CRI and Rg values.
- Drive current is referred to as nominal drive current.
- Products tested under pulsed condition (10ms pulse width) at nominal test current where T_j (junction temperature) - T_c (case temperature) = 25°C .
- Typical performance values are provided as a reference only and are not a guarantee of performance.
- Bridgelux maintains a $\pm 7\%$ tolerance on flux measurements.
- Minimum flux values at the nominal test current are guaranteed by 100% test.
- Nominal CCT is defined by the Lighting Research Center's Class A definition. The center of the Class A color bin is on the corresponding isothermal line.
- GAI value is 80. To help ensure optimal fixture level performance, GAI is measured at the fixture level, on axis, at a case temperature of 70°C . GAI may vary **3** depending on fixture design and performance.

Product Selection Guide

Table 1: Selection Guide, Pulsed Measurement Data ($T_j = T_c = 25^\circ\text{C}$) (continued)

Part Number	Nominal CCT ¹ (K)	CRI ²	Nominal Drive Current ³ (mA)	Typical Pulsed Flux ^{4,5,6} $T_c = 25^\circ\text{C}$ (lm)	Minimum Pulsed Flux ^{6,7} $T_c = 25^\circ\text{C}$ (lm)	Typical V_f (V)	Typical Power (W)	Typical Efficacy (lm/W)
BXRC-30H4000-B-7x	3000	97	900	3915	3524	34.8	31.3	125
BXRC-30H4000-C-7x	3000	97	1170	5090	4581	34.8	40.7	125
BXRC-30H4000-D-7x	3000	97	1050	3806	3426	29.0	30.5	125
BXRC-30A4001-B-7x ^{8,9}	3000	93	900	3884	3495	34.8	31.3	124
BXRC-30A4001-C-7x ^{8,9}	3000	93	1170	5049	4544	34.8	40.7	124
BXRC-30A4001-D-7x ^{8,9}	3000	93	1050	3776	3398	29.0	30.5	124
BXRC-35E4000-B-7x	3500	80	900	5450	4905	34.8	31.3	174
BXRC-35E4000-C-7x	3500	80	1170	7085	6376	34.8	40.7	174
BXRC-35E4000-D-7x	3500	80	1050	5298	4768	29.0	30.5	174
BXRC-35G4000-B-7x	3500	90	900	4479	4031	34.8	31.3	143
BXRC-35G4000-C-7x	3500	90	1170	5822	5240	34.8	40.7	143
BXRC-35G4000-D-7x	3500	90	1050	4354	3919	29.0	30.5	143
BXRC-35A4001-B-7x ^{8,9}	3500	93	900	4134	3721	34.8	31.3	132
BXRC-35A4001-C-7x ^{8,9}	3500	93	1170	5375	4837	34.8	40.7	132
BXRC-35A4001-D-7x ^{8,9}	3500	93	1050	4019	3617	29.0	30.5	132
BXRC-40C4001-B-7x	4000	70	900	5732	5158	34.8	31.3	183
BXRC-40C4001-C-7x	4000	70	1170	7451	6706	34.8	40.7	183
BXRC-40C4001-D-7x	4000	70	1050	5572	5015	29.0	30.5	183
BXRC-40E4000-B-7x	4000	80	900	5481	4933	34.8	31.3	175
BXRC-40E4000-C-7x	4000	80	1170	7125	6413	34.8	40.7	175
BXRC-40E4000-D-7x	4000	80	1050	5329	4796	29.0	30.5	175
BXRC-40G4000-B-7x	4000	90	900	4573	4115	34.8	31.3	146
BXRC-40G4000-C-7x	4000	90	1170	5945	5350	34.8	40.7	146
BXRC-40G4000-D-7x	4000	90	1050	4446	4001	29.0	30.5	146
BXRC-40H4000-B-7x	4000	97	900	4134	3721	34.8	31.3	132
BXRC-40H4000-C-7x	4000	97	1170	5375	4837	34.8	40.7	132
BXRC-40H4000-D-7x	4000	97	1050	4019	3617	29.0	30.5	132
BXRC-40A4001-B-7x ^{8,9}	4000	93	900	4479	4031	34.8	31.3	143
BXRC-40A4001-C-7x ^{8,9}	4000	93	1170	5822	5240	34.8	40.7	143
BXRC-40A4001-D-7x ^{8,9}	4000	93	1050	4354	3919	29.0	30.5	143
BXRC-50C4001-B-7x	5000	70	900	5763	5187	34.8	31.3	184
BXRC-50C4001-C-7x	5000	70	1170	7492	6743	34.8	40.7	184
BXRC-50C4001-D-7x	5000	70	1050	5603	5043	29.0	30.5	184
BXRC-50E4001-B-7x	5000	80	900	5544	4989	34.8	31.3	177
BXRC-50E4001-C-7x	5000	80	1170	7207	6486	34.8	40.7	177
BXRC-50E4001-D-7x	5000	80	1050	5390	4851	29.0	30.5	177

Notes for Table 1:

- Nominal CCT as defined by ANSI C78.377-2011. Products with a CCT of 5000K-6500K are hot targeted to $T_c = 85^\circ\text{C}$.
- CRI values are typical for Decor Series Ultra, Decor Series Street and Landmark and Decor Series Class A products. CRI values are minimums for all other products. Minimum R9 value for 80 CRI products is 0, the minimum R9 value for 90 CRI products is 50, the minimum R9 value for 97 CRI products is 93. Bridgelux maintains a ± 3 tolerance for all CRI and R9 values.
- Drive current is referred to as nominal drive current.
- Products tested under pulsed condition (10ms pulse width) at nominal test current where T_j (junction temperature) - T_c (case temperature) = 25°C .
- Typical performance values are provided as a reference only and are not a guarantee of performance.
- Bridgelux maintains a $\pm 7\%$ tolerance on flux measurements.
- Minimum flux values at the nominal test current are guaranteed by 100% test.
- Nominal CCT is defined by the Lighting Research Center's Class A definition. The center of the Class A color bin is on the corresponding isothermal line.
- GAI value is 80. To help ensure optimal fixture level performance, GAI is measured at the fixture level, on axis, at a case temperature of 70°C . GAI may vary depending on fixture design and performance.

Product Selection Guide

Table 1: Selection Guide, Pulsed Measurement Data ($T_j = T_c = 25^\circ\text{C}$) (continued)

Part Number	Nominal CCT ¹ (K)	CRI ²	Nominal Drive Current ³ (mA)	Typical Pulsed Flux ^{4,5,6} $T_c = 25^\circ\text{C}$ (lm)	Minimum Pulsed Flux ^{6,7} $T_c = 25^\circ\text{C}$ (lm)	Typical V_f (V)	Typical Power (W)	Typical Efficacy (lm/W)
BXRC-50G4001-B-7x	5000	90	900	4792	4313	34.8	31.3	153
BXRC-50G4001-C-7x	5000	90	1170	6230	5607	34.8	40.7	153
BXRC-50G4001-D-7x	5000	90	1050	4659	4193	29.0	30.5	153
BXRC-56G4000-B-7x	5600	90	900	4823	4341	34.8	31.3	154
BXRC-56G4000-C-7x	5600	90	1170	6270	5643	34.8	40.7	154
BXRC-56G400x-D-7x	5600	90	1050	4689	4220	29.0	30.5	154
BXRC-56H4000-D-7x	5600	97	1050	4233	3809	29.0	30.5	139
BXRC-57C4001-B-7x	5700	70	900	5606	5046	34.8	31.3	179
BXRC-57C4001-C-7x	5700	70	1170	7288	6559	34.8	40.7	179
BXRC-57C4001-D-7x	5700	70	1050	5451	4905	29.0	30.5	179
BXRC-57E4001-B-7x	5700	80	900	5324	4792	34.8	31.3	170
BXRC-57E4001-C-7x	5700	80	1170	6922	6230	34.8	40.7	170
BXRC-57E4001-D-7x	5700	80	1050	5177	4659	29.0	30.5	170
BXRC-65C4001-B-7x	6500	70	900	5606	5046	34.8	31.3	179
BXRC-65C4001-C-7x	6500	70	1170	7288	6559	34.8	40.7	179
BXRC-65C4001-D-7x	6500	70	1050	5451	4905	29.0	30.5	179
BXRC-65E4001-B-7x	6500	80	900	5387	4848	34.8	31.3	172
BXRC-65E4001-C-7x	6500	80	1170	7003	6303	34.8	40.7	172
BXRC-65E4001-D-7x	6500	80	1050	5237	4714	29.0	30.5	172

Notes for Table 1:

- Nominal CCT as defined by ANSI C78.377-2011. Products with a CCT of 5000K-6500K are hot targeted to $T_c = 85^\circ\text{C}$.
- CRI values are typical for Decor Series Ultra, Decor Series Street and Landmark and Decor Series Class A products. CRI values are minimums for all other products. Minimum Rg value for 80 CRI products is 0, the minimum Rg value for 90 CRI products is 50, the minimum Rg value for 97 CRI products is 93. Bridgelux maintains a ± 3 tolerance for all CRI and Rg values.
- Drive current is referred to as nominal drive current.
- Products tested under pulsed condition (10ms pulse width) at nominal test current where T_j (junction temperature) - T_c (case temperature) = 25°C .
- Typical performance values are provided as a reference only and are not a guarantee of performance.
- Bridgelux maintains a $\pm 7\%$ tolerance on flux measurements.
- Minimum flux values at the nominal test current are guaranteed by 100% test.
- Nominal CCT is defined by the Lighting Research Center's Class A definition. The center of the Class A color bin is on the corresponding isothermal line.
- GAI value is 80. To help ensure optimal fixture level performance, GAI is measured at the fixture level, on axis, at a case temperature of 70°C . GAI may vary depending on fixture design and performance.

Product Selection Guide

Table 2: Selection Guide, Stabilized DC Performance ($T_c = 70^\circ\text{C}$) ^{7,8}

Part Number	Nominal CCT ¹ (K)	GAI ²	CRI ³	Nominal Drive Current ⁴ (mA)	Typical DC Flux ^{5,6} $T_c = 70^\circ\text{C}$ (lm)	Minimum DC Flux ^{6,9} $T_c = 70^\circ\text{C}$ (lm)	Typical V_f (V)	Typical Power (W)	Typical Efficacy (lm/W)
BXRC-30A4001-B-7x	3000	80	93	900	3612	3251	34.3	30.9	116
BXRC-30A4001-C-7x	3000	80	93	1170	4695	4226	34.3	40.2	116
BXRC-30A4001-D-7x	3000	80	93	1050	3511	3160	28.5	29.9	116
BXRC-35A4001-B-7x	3500	80	93	900	3845	3460	34.3	30.9	123
BXRC-35A4001-C-7x	3500	80	93	1170	4998	4498	34.3	40.2	123
BXRC-35A4001-D-7x	3500	80	93	1050	3738	3364	28.5	29.9	123
BXRC-40A4001-B-7x	4000	80	93	900	4165	3749	34.3	30.9	133
BXRC-40A4001-C-7x	4000	80	93	1170	5415	4873	34.3	40.2	133
BXRC-40A4001-D-7x	4000	80	93	1050	4050	3645	28.5	29.9	133

Notes for Table 2:

- Nominal CCT is defined by the Lighting Research Center's Class A definition. The center of the Class A color bin is on the corresponding isothermal line.
- To help ensure optimal fixture level performance, GAI is measured at the fixture level, on axis, at a case temperature of 70°C . GAI may vary depending on fixture design and performance.
- CRI Values are specified as typical.
- Drive current is referred to as nominal drive current.
- Typical performance values are provided as a reference only and are not a guarantee of performance.
- Bridgelux maintains a $\pm 7\%$ tolerance on flux measurements.
- Typical stabilized DC performance values are provided as reference only and are not a guarantee of performance.
- Typical performance is estimated based on operation under DC (direct current) with LED array mounted onto a heat sink with thermal interface material and the case temperature maintained at specified temperature. Based on Bridgelux test setup, values may vary depending on the thermal design of the luminaire and/or the exposed environment to which the product is subjected.
- Minimum flux values at elevated temperatures are provided for reference only and are not guaranteed by 100% production testing. Based on Bridgelux test setup, values may vary depending on the thermal design of the luminaire and/or the exposed environment to which the product is subjected.

Product Selection Guide

Table 3: Selection Guide, Stabilized DC Performance ($T_c = 85^\circ\text{C}$)^{4,5}

Part Number	Nominal CCT ¹ (K)	CRI ²	Nominal Drive Current ³ (mA)	Typical DC Flux ^{4,5} $T_c = 85^\circ\text{C}$ (lm)	Minimum DC Flux ⁶ $T_c = 85^\circ\text{C}$ (lm)	Typical V_f (V)	Typical Power (W)	Typical Efficacy (lm/W)
BXRC-17E4000-B-7x	1750	80	900	2593	2334	33.9	30.5	85
BXRC-17E4000-C-7x	1750	80	1170	3261	2935	33.9	39.7	82
BXRC-17E4000-D-7x	1750	80	1050	2439	2195	28.1	29.5	83
BXRC-20B4001-C-7x	2000	65	1170	5753	5178	33.9	39.7	145
BXRC-20B4001-D-7x	2000	65	1050	4303	3872	28.1	29.5	146
BXRC-25E4000-B-7x	2500	80	900	4313	3881	33.9	30.5	141
BXRC-25E4000-C-7x	2500	80	1170	5607	5046	33.9	39.7	141
BXRC-25E4000-D-7x	2500	80	1050	4193	3774	28.1	29.5	142
BXRC-27E4000-B-7x	2700	80	900	4510	4059	33.9	30.5	148
BXRC-27E4000-C-7x	2700	80	1170	5863	5277	33.9	39.7	148
BXRC-27E4000-D-7x	2700	80	1050	4385	3946	28.1	29.5	149
BXRC-27G40H0-B-7x	2700	90	900	3862	3476	33.9	30.5	127
BXRC-27G40H0-C-7x	2700	90	1170	5020	4518	33.9	39.7	127
BXRC-27G40H0-D-7x	2700	90	1050	3754	3379	28.1	29.5	127
BXRC-27G4000-B-7x	2700	90	900	3721	3349	33.9	30.5	122
BXRC-27G4000-C-7x	2700	90	1170	4837	4353	33.9	39.7	122
BXRC-27G4000-D-7x	2700	90	1050	3617	3256	28.1	29.5	123
BXRC-27H4000-B-7x	2700	97	900	3298	2968	33.9	30.5	108
BXRC-27H4000-C-7x	2700	97	1170	4287	3859	33.9	39.7	108
BXRC-27H4000-D-7x	2700	97	1050	3206	2886	28.1	29.5	109
BXRC-30C4001-B-7x	3000	70	900	5017	4516	33.9	30.5	164
BXRC-30C4001-C-7x	3000	70	1170	6523	5870	33.9	39.7	164
BXRC-30C4001-D-7x	3000	70	1050	4878	4390	28.1	29.5	165
BXRC-30E4000-B-7x	3000	80	900	4792	4313	33.9	30.5	157
BXRC-30E4000-C-7x	3000	80	1170	6230	5607	33.9	39.7	157
BXRC-30E4000-D-7x	3000	80	1050	4659	4193	28.1	29.5	158
BXRC-30G40H0-B-7x	3000	90	900	3890	3501	33.9	30.5	127
BXRC-30G40H0-C-7x	3000	90	1170	5057	4551	33.9	39.7	127
BXRC-30G40H0-D-7x	3000	90	1050	3782	3404	28.1	29.5	128
BXRC-30G4000-B-7x	3000	90	900	4059	3653	33.9	30.5	133
BXRC-30G4000-C-7x	3000	90	1170	5277	4749	33.9	39.7	133
BXRC-30G4000-D-7x	3000	90	1050	3946	3552	28.1	29.5	134
BXRC-30G400C-B-7x	3000	90	900	3749	3374	33.9	30.5	123
BXRC-30G400C-D-7x	3000	90	1050	3645	3280	28.1	29.5	124
BXRC-30H4000-B-7x	3000	97	900	3524	3171	33.9	30.5	115

Notes for Table 3:

- Nominal CCT as defined by ANSI C78.377-2011. Products with a CCT of 5000K-6500K are hot targeted to $T_c = 85^\circ\text{C}$.
- All CRI values are measured at $T_c = T_a = 25^\circ\text{C}$. CRI values are typical for Decor Series Ultra, Decor Series Street and Landmark and Decor Series Class A products. CRI values are minimums for all other products. Minimum Rg value for 80 CRI products is 0, the minimum Rg value for 90 CRI products is 50, the minimum Rg value for 97 CRI products is 93. Bridgelux maintains a ± 3 tolerance for all CRI and Rg values.
- Drive current is referred to as nominal drive current.
- Typical stabilized DC performance values are provided as reference only and are not a guarantee of performance.
- Typical performance is estimated based on operation under DC (direct current) with LED array mounted onto a heat sink with thermal interface material and the case temperature maintained at 85°C . Based on Bridgelux test setup, values may vary depending on the thermal design of the luminaire and/or the exposed environment to which the product is subjected.
- Minimum flux values at elevated temperatures are provided for reference only and are not guaranteed by 100% production testing. Based on Bridgelux test setup, values may vary depending on the thermal design of the luminaire and/or the exposed environment to which the product is subjected.
- Nominal CCT is defined by the Lighting Research Center's Class A definition. The center of the Class A color bin is on the corresponding isothermal line.
- GAI value is 80. To help ensure optimal fixture level performance, GAI is measured at the fixture level, on axis, at a case temperature of 70°C . GAI may vary depending on fixture design and performance.

Product Selection Guide

Table 3: Selection Guide, Stabilized DC Performance ($T_c = 85^\circ\text{C}$)^{4,5} (continued)

Part Number	Nominal CCT ¹ (K)	CRI ²	Nominal Drive Current ³ (mA)	Typical DC Flux ^{4,5} $T_c = 85^\circ\text{C}$ (lm)	Minimum DC Flux ⁶ $T_c = 85^\circ\text{C}$ (lm)	Typical V_f (V)	Typical Power (W)	Typical Efficacy (lm/W)
BXRC-30H4000-C-7x	3000	97	1170	4581	4122	33.9	39.7	115
BXRC-30H4000-D-7x	3000	97	1050	3426	3083	28.1	29.5	116
BXRC-30A4001-B-7x ^{8,9}	3000	93	900	3495	3146	33.9	30.5	115
BXRC-30A4001-C-7x ^{8,9}	3000	93	1170	4544	4090	33.9	39.7	115
BXRC-30A4001-D-7x ^{8,9}	3000	93	1050	3398	3058	28.1	29.5	115
BXRC-35E4000-B-7x	3500	80	900	4905	4414	33.9	30.5	161
BXRC-35E4000-C-7x	3500	80	1170	6376	5739	33.9	39.7	161
BXRC-35E4000-D-7x	3500	80	1050	4768	4292	28.1	29.5	162
BXRC-35G4000-B-7x	3500	90	900	4031	3628	33.9	30.5	132
BXRC-35G4000-C-7x	3500	90	1170	5240	4716	33.9	39.7	132
BXRC-35G4000-D-7x	3500	90	1050	3919	3527	28.1	29.5	133
BXRC-35A4001-B-7x ^{8,9}	3500	93	900	3721	3349	33.9	30.5	122
BXRC-35A4001-C-7x ^{8,9}	3500	93	1170	4837	4353	33.9	39.7	122
BXRC-35A4001-D-7x ^{8,9}	3500	93	1050	3617	3256	28.1	29.5	123
BXRC-40C4001-B-7x	4000	70	900	5158	4643	33.9	30.5	169
BXRC-40C4001-C-7x	4000	70	1170	6706	6035	33.9	39.7	169
BXRC-40C4001-D-7x	4000	70	1050	5015	4514	28.1	29.5	170
BXRC-40E4000-B-7x	4000	80	900	4933	4440	33.9	30.5	162
BXRC-40E4000-C-7x	4000	80	1170	6413	5771	33.9	39.7	162
BXRC-40E4000-D-7x	4000	80	1050	4796	4316	28.1	29.5	163
BXRC-40G4000-B-7x	4000	90	900	4115	3704	33.9	30.5	135
BXRC-40G4000-C-7x	4000	90	1170	5350	4815	33.9	39.7	135
BXRC-40G4000-D-7x	4000	90	1050	4001	3601	28.1	29.5	136
BXRC-40H4000-B-7x	4000	97	900	3721	3349	33.9	30.5	122
BXRC-40H4000-C-7x	4000	97	1170	4837	4353	33.9	39.7	122
BXRC-40H4000-D-7x	4000	97	1050	3617	3256	28.1	29.5	123
BXRC-40A4001-B-7x ^{7,8}	4000	93	900	4031	3628	33.9	30.5	132
BXRC-40A4001-C-7x ^{7,8}	4000	93	1170	5240	4716	33.9	39.7	132
BXRC-40A4001-D-7x ^{7,8}	4000	93	1050	3919	3527	28.1	29.5	133
BXRC-50C4001-B-7x	5000	70	900	5187	4668	33.9	30.5	170
BXRC-50C4001-C-7x	5000	70	1170	6743	6068	33.9	39.7	170
BXRC-50C4001-D-7x	5000	70	1050	5043	4538	28.1	29.5	171
BXRC-50E4001-B-7x	5000	80	900	4989	4490	33.9	30.5	164
BXRC-50E4001-C-7x	5000	80	1170	6486	5837	33.9	39.7	164
BXRC-50E4001-D-7x	5000	80	1050	4851	4366	28.1	29.5	164

Notes for Table 3:

- Nominal CCT as defined by ANSI C78.377-2011. Products with a CCT of 5000K-6500K are hot targeted to $T_c = 85^\circ\text{C}$.
- All CRI values are measured at $T_c = T_a = 25^\circ\text{C}$. CRI values are typical for Decor Series Ultra, Decor Series Street and Landmark and Decor Series Class A products. CRI values are minimums for all other products. Minimum Rg value for 80 CRI products is 0, the minimum Rg value for 90 CRI products is 50, the minimum Rg value for 97 CRI products is 93. Bridgelux maintains a ± 3 tolerance for all CRI and Rg values.
- Drive current is referred to as nominal drive current.
- Typical stabilized DC performance values are provided as reference only and are not a guarantee of performance.
- Typical performance is estimated based on operation under DC (direct current) with LED array mounted onto a heat sink with thermal interface material and the case temperature maintained at 85°C . Based on Bridgelux test setup, values may vary depending on the thermal design of the luminaire and/or the exposed environment to which the product is subjected.
- Minimum flux values at elevated temperatures are provided for reference only and are not guaranteed by 100% production testing. Based on Bridgelux test setup, values may vary depending on the thermal design of the luminaire and/or the exposed environment to which the product is subjected.
- Nominal CCT is defined by the Lighting Research Center's Class A definition. The center of the Class A color bin is on the corresponding isothermal line.
- GAI value is 80. To help ensure optimal fixture level performance, GAI is measured at the fixture level, on axis, at a case temperature of 70°C . GAI may vary depending on fixture design and performance.

Product Selection Guide

Table 3: Selection Guide, Stabilized DC Performance ($T_c = 85^\circ\text{C}$)^{4,5} (continued)

Part Number	Nominal CCT ¹ (K)	CRI ²	Nominal Drive Current ³ (mA)	Typical DC Flux ^{4,5} $T_c = 85^\circ\text{C}$ (lm)	Minimum DC Flux ⁶ $T_c = 85^\circ\text{C}$ (lm)	Typical V_f (V)	Typical Power (W)	Typical Efficacy (lm/W)
BXRC-50G4001-B-7x	5000	90	900	4313	3881	33.9	30.5	141
BXRC-50G4001-C-7x	5000	90	1170	5607	5046	33.9	39.7	141
BXRC-50G4001-D-7x	5000	90	1050	4193	3774	28.1	29.5	142
BXRC-56G4000-B-7x	5600	90	900	4341	3907	33.9	30.5	142
BXRC-56G4000-C-7x	5600	90	1170	5643	5079	33.9	39.7	142
BXRC-56G400x-D-7x	5600	90	1050	4220	3798	28.1	29.5	143
BXRC-56H4000-D-7x	5600	97	1050	3809	3428	28.1	29.5	129
BXRC-57C4001-B-7x	5700	70	900	5046	4541	33.9	30.5	165
BXRC-57C4001-C-7x	5700	70	1170	6559	5903	33.9	39.7	165
BXRC-57C4001-D-7x	5700	70	1050	4905	4415	28.1	29.5	166
BXRC-57E4001-B-7x	5700	80	900	4792	4313	33.9	30.5	157
BXRC-57E4001-C-7x	5700	80	1170	6230	5607	33.9	39.7	157
BXRC-57E4001-D-7x	5700	80	1050	4659	4193	28.1	29.5	158
BXRC-65C4001-B-7x	6500	70	900	5046	4541	33.9	30.5	165
BXRC-65C4001-C-7x	6500	70	1170	6559	5903	33.9	39.7	165
BXRC-65C4001-D-7x	6500	70	1050	4905	4415	28.1	29.5	166
BXRC-65E4001-B-7x	6500	80	900	4848	4364	33.9	30.5	159
BXRC-65E4001-C-7x	6500	80	1170	6303	5673	33.9	39.7	159
BXRC-65E4001-D-7x	6500	80	1050	4714	4242	28.1	29.5	160

Notes for Table 3:

- Nominal CCT as defined by ANSI C78.377-2011. Products with a CCT of 5000K-6500K are hot targeted to $T_c = 85^\circ\text{C}$.
- All CRI values are measured at $T_1 = T_2 = 25^\circ\text{C}$. CRI values are typical for Decor Series Ultra, Decor Series Street and Landmark and Decor Series Class A products. CRI values are minimums for all other products. Minimum Rg value for 80 CRI products is 0, the minimum Rg value for 90 CRI products is 50, the minimum Rg value for 97 CRI products is 93. Bridgelux maintains a ± 3 tolerance for all CRI and Rg values.
- Drive current is referred to as nominal drive current.
- Typical stabilized DC performance values are provided as reference only and are not a guarantee of performance.
- Typical performance is estimated based on operation under DC (direct current) with LED array mounted onto a heat sink with thermal interface material and the case temperature maintained at 85°C . Based on Bridgelux test setup, values may vary depending on the thermal design of the luminaire and/or the exposed environment to which the product is subjected.
- Minimum flux values at elevated temperatures are provided for reference only and are not guaranteed by 100% production testing. Based on Bridgelux test setup, values may vary depending on the thermal design of the luminaire and/or the exposed environment to which the product is subjected.
- Nominal CCT is defined by the Lighting Research Center's Class A definition. The center of the Class A color bin is on the corresponding isothermal line.
- GAI value is 80. To help ensure optimal fixture level performance, GAI is measured at the fixture level, on axis, at a case temperature of 70°C . GAI may vary depending on fixture design and performance.

European Product Registry for Energy Labeling

The European Product Registry for Energy Labeling (EPREL) is defined in the EU Regulation 2017/1369 to provide important energy efficiency information to consumers. Together with Energy Labeling Regulation ELR (EU) 2019/2015 which was amended by regulation (EU) 2021/340 for energy labelling of light sources, manufacturers are required to declare an energy class based on key technical specifications from each of their product and register it in an open data base managed by EPREL. It is now a legal requirement for a vendor of light sources to upload information about their products into the EPREL database before placing these products on the market in the EU.

Table 4 below provides a list of part numbers that are in compliance with ELR and are currently listed in the EPREL database.

At Bridgelux, we are fully committed to supplying products that are compliant with pertinent laws, rules, and obligation imposed by relevant government bodies including the European Energy Labeling regulation. Customers can use these products with full confidence for any projects that fall under the ELR.

Table 4: Part numbers registered in European Product Registry for Energy Labeling

PART NUMBER ¹	CCT (K)	CRI	Current ² (mA)	Vf (V)	Useful flux ³ (Φ_{use}) at 85C (lm)	Power (W)	Efficacy (lm/W)	Energy efficiency class ⁴	Registration No	URL to Product Information Sheet in EPREL Database
BXRC-20B4001-C-7x	2000	65	1900	34.2	8401	65.0	129	E	870977	https://eprelec.europa.eu/qr/870977
BXRC-20B4001-D-7x	2000	65	1720	29.9	6626	51.5	129	E	870979	https://eprelec.europa.eu/qr/870979
BXRC-25E4000-B-7x	2500	80	1800	35.2	7490	63.4	118	F	870988	https://eprelec.europa.eu/qr/870988
BXRC-25E4000-C-7x	2500	80	2340	35.2	9736	82.4	118	F	870990	https://eprelec.europa.eu/qr/870990
BXRC-25E4000-D-7x	2500	80	2100	30.8	7623	64.6	118	F	870992	https://eprelec.europa.eu/qr/870992
BXRC-27E4000-B-7x	2700	80	1800	35.2	7832	63.4	124	E	871049	https://eprelec.europa.eu/qr/871049
BXRC-27E4000-C-7x	2700	80	2340	35.2	10182	82.4	124	E	871054	https://eprelec.europa.eu/qr/871054
BXRC-27E4000-D-7x	2700	80	2100	30.8	7971	64.6	123	E	871060	https://eprelec.europa.eu/qr/871060
BXRC-27G40H0-B-7x	2700	90	1580	34.6	6023	54.6	110	F	871171	https://eprelec.europa.eu/qr/871171
BXRC-27G40H0-C-7x	2700	90	2020	34.5	7721	69.7	111	F	871175	https://eprelec.europa.eu/qr/871175
BXRC-27G40H0-D-7x	2700	90	1840	30.2	6121	55.6	110	F	871179	https://eprelec.europa.eu/qr/871179
BXRC-27G4000-B-7x	2700	90	1410	34.1	5268	48.0	110	F	871154	https://eprelec.europa.eu/qr/871154
BXRC-27G4000-C-7x	2700	90	1780	33.9	6676	60.4	110	F	871159	https://eprelec.europa.eu/qr/871159
BXRC-27G4000-D-7x	2700	90	1630	29.7	5319	48.5	110	F	871165	https://eprelec.europa.eu/qr/871165
BXRC-27H4000-B-7x	2700	95	980	32.8	3369	32.1	105	F	871221	https://eprelec.europa.eu/qr/871221
BXRC-27H4000-C-7x	2700	95	1210	32.6	4176	39.5	106	F	871225	https://eprelec.europa.eu/qr/871225
BXRC-27H4000-D-7x	2700	95	1140	28.6	3420	32.6	105	F	871229	https://eprelec.europa.eu/qr/871229

Notes for Table 4:

1. All device listed here must be disposed as e-waste upon its end of life according to local country guideline in each country.
2. For information on performance values at alternative drive conditions, please refer to the Product Selection Guide, Absolute Maximum Rating Table and Performance Curves in this data sheet.
3. For a definition of useful luminous flux (Φ_{use}), please see the ELR regulations at <https://tinyurl.com/4b6zvt4m>.
4. EPREL requires an arrow symbol containing the letter of the energy efficiency class to be displayed, on technical promotional material. Refer to this energy efficiency class column for specific energy efficiency class on each part number.

European Product Registry for Energy Labeling

Table 4: Part numbers registered in European Product Registry for Energy Labeling (Continued)

PART NUMBER ¹	CCT (K)	CRI	Current ² (mA)	Vf (V)	Useful flux ³ (Φ_{use}) at 85C (lm)	Power (W)	Efficacy (lm/W)	Energy efficiency class ⁴	Registration No	URL to Product Information Sheet in EPREL Database
BXRC-30C4001-B-7x	3000	70	1800	35.2	8713	63.4	137	E	871310	https://eprelec.europa.eu/qr/871310
BXRC-30C4001-C-7x	3000	70	2340	35.2	11327	82.4	137	E	871316	https://eprelec.europa.eu/qr/871316
BXRC-30C4001-D-7x	3000	70	2100	30.8	8868	64.6	137	E	871322	https://eprelec.europa.eu/qr/871322
BXRC-30E4000-B-7x	3000	80	1800	35.2	8322	63.4	131	E	871379	https://eprelec.europa.eu/qr/871379
BXRC-30E4000-C-7x	3000	80	2340	35.2	10818	82.4	131	E	871384	https://eprelec.europa.eu/qr/871384
BXRC-30E4000-D-7x	3000	80	2100	30.8	8470	64.6	131	E	871390	https://eprelec.europa.eu/qr/871390
BXRC-30G40H0-B-7x	3000	90	1800	35.2	7049	63.4	111	F	871517	https://eprelec.europa.eu/qr/871517
BXRC-30G40H0-C-7x	3000	90	2340	35.2	9164	82.4	111	F	871521	https://eprelec.europa.eu/qr/871521
BXRC-30G40H0-D-7x	3000	90	2100	30.8	7174	64.6	111	F	871525	https://eprelec.europa.eu/qr/871525
BXRC-30G4000-B-7x	3000	90	1620	34.7	6194	56.2	110	F	871496	https://eprelec.europa.eu/qr/871496
BXRC-30G4000-C-7x	3000	90	2070	34.6	7938	71.6	111	F	871501	https://eprelec.europa.eu/qr/871501
BXRC-30G4000-D-7x	3000	90	1880	30.3	6277	56.9	110	F	871507	https://eprelec.europa.eu/qr/871507
BXRC-30G400C-B-7x	3000	90	1620	34.7	6194	56.2	110	F	871513	https://eprelec.europa.eu/qr/871513
BXRC-30G400C-D-7x	3000	90	1880	30.3	6277	56.9	110	F	871515	https://eprelec.europa.eu/qr/871515
BXRC-30H4000-B-7x	3000	95	1290	33.7	4615	43.5	106	F	871567	https://eprelec.europa.eu/qr/871567
BXRC-30H4000-C-7x	3000	95	1620	33.6	5819	54.4	107	F	871571	https://eprelec.europa.eu/qr/871571
BXRC-30H4000-D-7x	3000	95	1490	29.4	4656	43.8	106	F	871575	https://eprelec.europa.eu/qr/871575
BXRC-30A4001-B-7x	3000	90	1110	33.2	4002	36.8	109	F	871250	https://eprelec.europa.eu/qr/871250
BXRC-30A4001-C-7x	3000	90	1390	33.0	5028	45.9	109	F	871251	https://eprelec.europa.eu/qr/871251
BXRC-30A4001-D-7x	3000	90	1290	29.0	4058	37.4	109	F	871252	https://eprelec.europa.eu/qr/871252
BXRC-35E4000-B-7x	3500	80	1800	35.2	8518	63.4	134	E	871653	https://eprelec.europa.eu/qr/871653
BXRC-35E4000-C-7x	3500	80	2340	35.2	11073	82.4	134	E	871658	https://eprelec.europa.eu/qr/871658
BXRC-35E4000-D-7x	3500	80	2100	30.8	8669	64.6	134	E	871663	https://eprelec.europa.eu/qr/871663
BXRC-35G4000-B-7x	3500	90	1780	35.1	6927	62.6	111	F	871720	https://eprelec.europa.eu/qr/871720
BXRC-35G4000-C-7x	3500	90	2280	35.1	8900	80.0	111	F	871725	https://eprelec.europa.eu/qr/871725
BXRC-35G4000-D-7x	3500	90	2070	30.7	7032	63.6	111	F	871730	https://eprelec.europa.eu/qr/871730
BXRC-35A4001-B-7x	3500	90	1410	34.1	5268	48.0	110	F	871596	https://eprelec.europa.eu/qr/871596
BXRC-35A4001-C-7x	3500	90	1780	33.9	6676	60.4	110	F	871597	https://eprelec.europa.eu/qr/871597
BXRC-35A4001-D-7x	3500	90	1630	29.7	5319	48.5	110	F	871598	https://eprelec.europa.eu/qr/871598
BXRC-40C4001-B-7x	4000	70	1800	35.2	8958	63.4	141	E	871815	https://eprelec.europa.eu/qr/871815
BXRC-40C4001-C-7x	4000	70	2340	35.2	11646	82.4	141	E	871821	https://eprelec.europa.eu/qr/871821
BXRC-40C4001-D-7x	4000	70	2100	30.8	9117	64.6	141	E	871827	https://eprelec.europa.eu/qr/871827
BXRC-40E4000-B-7x	4000	80	1800	35.2	8566	63.4	135	E	871885	https://eprelec.europa.eu/qr/871885
BXRC-40E4000-C-7x	4000	80	2340	35.2	11136	82.4	135	E	871890	https://eprelec.europa.eu/qr/871890
BXRC-40E4000-D-7x	4000	80	2100	30.8	8719	64.6	135	E	871896	https://eprelec.europa.eu/qr/871896

Notes for Table 4:

- All device listed here must be disposed as e-waste upon its end of life according to local country guideline in each country.
- For information on performance values at alternative drive conditions, please refer to the Product Selection Guide, Absolute Maximum Rating Table and Performance Curves in this data sheet.
- For a definition of useful luminous flux (Φ_{use}), please see the ELR regulations at <https://tinyurl.com/4b6zvt4m>.
- EPREL requires an arrow symbol containing the letter of the energy efficiency class to be displayed, on technical promotional material. Refer to this energy efficiency class column for specific energy efficiency class on each part number.

European Product Registry for Energy Labeling

Table 4: Part numbers registered in European Product Registry for Energy Labeling (Continued)

PART NUMBER ¹	CCT (K)	CRI	Current ² (mA)	Vf (V)	Useful flux ³ (Φ_{use}) at 85C (lm)	Power (W)	Efficacy (lm/W)	Energy efficiency class ⁴	Registration No	URL to Product Information Sheet in EPREL Database
BXRC-40G4000-B-7x	4000	90	1800	35.2	7147	63.4	113	F	871954	https://eprel.ec.europa.eu/qr/871954
BXRC-40G4000-C-7x	4000	90	2340	35.2	9291	82.4	113	F	871959	https://eprel.ec.europa.eu/qr/871959
BXRC-40G4000-D-7x	4000	90	2100	30.8	7274	64.6	113	F	871964	https://eprel.ec.europa.eu/qr/871964
BXRC-40H4000-B-7x	4000	95	1540	34.4	5680	53.0	107	F	871984	https://eprel.ec.europa.eu/qr/871984
BXRC-40H4000-C-7x	4000	95	1970	34.4	7284	67.7	108	F	871986	https://eprel.ec.europa.eu/qr/871986
BXRC-40H4000-D-7x	4000	95	1790	30.1	5763	53.9	107	F	871988	https://eprel.ec.europa.eu/qr/871988
BXRC-40A4001-B-7x	4000	90	1780	35.1	6927	62.6	111	F	871751	https://eprel.ec.europa.eu/qr/871751
BXRC-40A4001-C-7x	4000	90	2280	35.1	8900	80.0	111	F	871752	https://eprel.ec.europa.eu/qr/871752
BXRC-40A4001-D-7x	4000	90	2070	30.7	7032	63.6	111	F	871753	https://eprel.ec.europa.eu/qr/871753
BXRC-50C4001-B-7x	5000	70	1800	35.2	9007	63.4	142	E	872033	https://eprel.ec.europa.eu/qr/872033
BXRC-50C4001-C-7x	5000	70	2340	35.2	11709	82.4	142	E	872037	https://eprel.ec.europa.eu/qr/872037
BXRC-50C4001-D-7x	5000	70	2100	30.8	9167	64.6	142	E	872041	https://eprel.ec.europa.eu/qr/872041
BXRC-50E4001-B-7x	5000	80	1800	35.2	8664	63.4	137	E	872085	https://eprel.ec.europa.eu/qr/872085
BXRC-50E4001-C-7x	5000	80	2340	35.2	11264	82.4	137	E	872089	https://eprel.ec.europa.eu/qr/872089
BXRC-50E4001-D-7x	5000	80	2100	30.8	8818	64.6	136	E	872093	https://eprel.ec.europa.eu/qr/872093
BXRC-50G4001-B-7x	5000	90	1800	35.2	7490	63.4	118	F	872138	https://eprel.ec.europa.eu/qr/872138
BXRC-50G4001-C-7x	5000	90	2340	35.2	9736	82.4	118	F	872142	https://eprel.ec.europa.eu/qr/872142
BXRC-50G4001-D-7x	5000	90	2100	30.8	7623	64.6	118	F	872146	https://eprel.ec.europa.eu/qr/872146
BXRC-56G4000-B-7x	5600	90	1800	35.2	7539	63.4	119	E	872162	https://eprel.ec.europa.eu/qr/872162
BXRC-56G4000-C-7x	5600	90	2340	35.2	9800	82.4	119	E	872163	https://eprel.ec.europa.eu/qr/872163
BXRC-56H4000-D-7x	5600	95	2070	30.7	6835	63.6	108	F	872200	https://eprel.ec.europa.eu/qr/872200
BXRC-57C4001-B-7x	5700	70	1800	35.2	8762	63.4	138	E	872241	https://eprel.ec.europa.eu/qr/872241
BXRC-57C4001-C-7x	5700	70	2340	35.2	11391	82.4	138	E	872245	https://eprel.ec.europa.eu/qr/872245
BXRC-57C4001-D-7x	5700	70	2100	30.8	8918	64.6	138	E	872249	https://eprel.ec.europa.eu/qr/872249
BXRC-57E4001-B-7x	5700	80	1800	35.2	8322	63.4	131	E	872289	https://eprel.ec.europa.eu/qr/872289
BXRC-57E4001-C-7x	5700	80	2340	35.2	10818	82.4	131	E	872293	https://eprel.ec.europa.eu/qr/872293
BXRC-57E4001-D-7x	5700	80	2100	30.8	8470	64.6	131	E	872297	https://eprel.ec.europa.eu/qr/872297
BXRC-65C4001-B-7x	6500	70	1800	35.2	8762	63.4	138	E	872338	https://eprel.ec.europa.eu/qr/872338
BXRC-65C4001-C-7x	6500	70	2340	35.2	11391	82.4	138	E	872342	https://eprel.ec.europa.eu/qr/872342
BXRC-65C4001-D-7x	6500	70	2100	30.8	8918	64.6	138	E	872346	https://eprel.ec.europa.eu/qr/872346
BXRC-65E4001-B-7x	6500	80	1800	35.2	8420	63.4	133	E	872387	https://eprel.ec.europa.eu/qr/872387
BXRC-65E4001-C-7x	6500	80	2340	35.2	10946	82.4	133	E	872391	https://eprel.ec.europa.eu/qr/872391
BXRC-65E4001-D-7x	6500	80	2100	30.8	8569	64.6	133	E	872395	https://eprel.ec.europa.eu/qr/872395

Notes for Table 4:

- All device listed here must be disposed as e-waste upon its end of life according to local country guideline in each country.
- For information on performance values at alternative drive conditions, please refer to the Product Selection Guide, Absolute Maximum Rating Table and Performance Curves in this data sheet.
- For a definition of useful luminous flux (Φ_{use}), please see the ELR regulations at <https://tinyurl.com/4b6zv4m>.
- EPREL requires an arrow symbol containing the letter of the energy efficiency class to be displayed, on technical promotional material. Refer to this energy efficiency class column for specific energy efficiency class on each part number.

Performance at Commonly Used Drive Currents

Vero LED arrays are tested to the specifications shown using the nominal drive currents in Table 1. Vero may also be driven at other drive currents dependent on specific application design requirements. The performance at any drive current can be derived from the current vs. voltage characteristics shown in Figures 1, 2 & 3 and the flux vs. current characteristics shown in Figures 4, 5 & 6. The performance at commonly used drive currents is summarized in Table 5.

Table 5: Product Performance at Commonly Used Drive Currents

Part Number	CRI	Drive Current ¹ (mA)	Typical V_f $T_c = 25^\circ\text{C}$ (V)	Typical Power $T_c = 25^\circ\text{C}$ (W)	Typical Flux ² $T_c = 25^\circ\text{C}$ (lm)	Typical DC Flux ³ $T_c = 85^\circ\text{C}$ (lm)	Typical Efficacy $T_c = 25^\circ\text{C}$ (lm/W)
BXRC-17E4000-B-7x	80	450	33.2	14.9	1547	1390	104
		600	34.0	20.4	2029	1820	99
		900	34.8	31.3	2881	2593	92
		1350	35.6	48.1	4286	3776	89
		1800	36.1	65.1	5515	4794	85
BXRC-17E4000-C-7x	80	585	33.2	19.4	1946	1748	100
		780	34.0	26.5	2552	2289	96
		1170	34.8	40.7	3624	3261	89
		1755	35.6	62.5	5390	4749	86
		2340	36.1	84.6	6935	6029	82
BXRC-17E4000-D-7x	80	525	27.7	14.6	1455	1307	100
		700	28.2	19.8	1909	1712	97
		1050	29.0	30.5	2710	2439	89
		1575	30.4	47.9	4031	3551	84
		2100	31.5	66.2	5187	4509	78
BXRC-20B4001-C-7x	65	585	33.2	19.4	3432	3084	177
		780	34.0	26.5	4502	4038	170
		1170	34.8	40.7	6392	5753	157
		1755	35.6	62.5	9507	8377	152
		2340	36.1	84.6	12234	10635	145
BXRC-20B4001-D-7x	65	525	27.7	14.6	2567	2306	176
		700	28.2	19.8	3367	3020	170
		1050	29.0	30.5	4781	4303	157
		1575	30.4	47.9	7110	6265	148
		2100	31.5	66.2	9150	7954	138
BXRC-25E4000-B-7x	80	450	33.2	14.9	2573	2312	172
		600	34.0	20.4	3375	3027	165
		900	34.8	31.3	4792	4313	153
		1350	35.6	48.1	7127	6280	148
		1800	36.1	65.1	9171	7972	141
BXRC-25E4000-C-7x	80	585	33.2	19.4	3345	3005	172
		780	34.0	26.5	4387	3935	165
		1170	34.8	40.7	6230	5102	153
		1755	35.6	62.5	9265	8164	148
		2340	36.1	84.6	11923	10364	141
BXRC-25E4000-D-7x	80	525	27.7	14.6	2501	2248	172
		700	28.2	19.8	3281	2943	166
		1050	29.0	30.5	4659	4193	153
		1575	30.4	47.9	6929	6105	145
		2100	31.5	66.2	8917	7751	135

Notes for Table 5:

1. Alternate drive currents are provided for reference only and are not a guarantee of performance.
2. Bridgelux maintains a $\pm 7\%$ tolerance on flux measurements.
3. Typical stabilized DC performance values are provided as reference only and are not a guarantee of performance.

Performance at Commonly Used Drive Currents

Table 5: Product Performance at Commonly Used Drive Currents (Continued)

Part Number	CRI	Drive Current ¹ (mA)	Typical V _f T _c = 25°C (V)	Typical Power T _c = 25°C (W)	Typical Flux ² T _c = 25°C (lm)	Typical DC Flux ³ T _c = 85°C (lm)	Typical Efficacy T _c = 25°C (lm/W)
BXRC-27E4000-B-7x	80	450	33.2	14.9	2691	2418	180
		600	34.0	20.4	3529	3166	173
		900	34.8	31.3	5011	4510	160
		1350	35.6	48.1	7453	6567	155
		1800	36.1	65.1	9591	8337	147
BXRC-27E4000-C-7x	80	585	33.2	19.4	3404	3221	175
		780	34.0	26.5	4460	4133	168
		1170	34.8	40.7	6515	5863	160
		1755	35.6	62.5	9372	8249	150
		2340	36.1	84.6	12021	10361	142
BXRC-27E4000-D-7x	80	525	27.7	14.6	2595	2409	178
		700	28.2	19.8	3375	3093	171
		1050	29.0	30.5	4872	4385	160
		1575	30.4	47.9	6959	6154	145
		2100	31.5	66.2	8859	7704	134
BXRC-27G40H0-B-7x	90	450	33.2	14.9	2304	2070	154
		600	34.0	20.4	3022	2711	148
		900	34.8	31.3	4291	3862	137
		1350	35.6	48.1	6382	5623	133
		1800	36.1	65.1	8212	7139	126
BXRC-27G40H0-C-7x	90	585	33.2	19.4	2914	2758	150
		780	34.0	26.5	3819	3539	144
		1170	34.8	40.7	5578	5020	137
		1755	35.6	62.5	8025	7063	128
		2340	36.1	84.6	10293	8872	122
BXRC-27G40H0-D-7x	90	525	27.7	14.6	2222	2063	153
		700	28.2	19.8	2890	2648	146
		1050	29.0	30.5	4172	3754	137
		1575	30.4	47.9	5959	5269	124
		2100	31.5	66.2	7585	6596	115
BXRC-27G4000-B-7x	90	450	33.2	14.9	2220	1995	149
		600	34.0	20.4	2912	2612	143
		900	34.8	31.3	4134	3721	132
		1350	35.6	48.1	6149	5418	128
		1800	36.1	65.1	7913	6878	122
BXRC-27G4000-C-7x	90	585	33.2	19.4	2808	2658	145
		780	34.0	26.5	3680	3410	139
		1170	34.8	40.7	5375	4837	132
		1755	35.6	62.5	7732	6805	124
		2340	36.1	84.6	9918	8548	117
BXRC-27G4000-D-7x	90	525	27.7	14.6	2141	1987	147
		700	28.2	19.8	2784	2552	141
		1050	29.0	30.5	4019	3617	132
		1575	30.4	47.9	5741	5077	120
		2100	31.5	66.2	7308	6355	110

Notes for Table 5:

1. Alternate drive currents are provided for reference only and are not a guarantee of performance.
2. Bridgelux maintains a ± 7% tolerance on flux measurements.
3. Typical stabilized DC performance values are provided as reference only and are not a guarantee of performance.

Performance at Commonly Used Drive Currents

Table 5: Product Performance at Commonly Used Drive Currents (Continued)

Part Number	CRI	Drive Current ¹ (mA)	Typical V _f T _c = 25°C (V)	Typical Power T _c = 25°C (W)	Typical Flux ² T _c = 25°C (lm)	Typical DC Flux ³ T _c = 85°C (lm)	Typical Efficacy T _c = 25°C (lm/W)
BXRC-27H4000-B-7x	97	450	33.2	14.9	1967	1812	132
		600	34.0	20.4	2581	2326	126
		900	34.8	31.3	3664	3298	117
		1350	35.6	48.1	5450	4628	113
		1800	36.1	65.1	7013	5794	108
BXRC-27H4000-C-7x	97	585	33.2	19.4	2489	2355	128
		780	34.0	26.5	3262	3024	123
		1170	34.8	40.7	4764	4287	117
		1755	35.6	62.5	6853	6017	110
		2340	36.1	84.6	8791	7532	104
BXRC-27H4000-D-7x	97	525	27.7	14.6	1898	1762	130
		700	28.2	19.8	2468	2262	125
		1050	29.0	30.5	3563	3206	117
		1575	30.4	47.9	5089	4500	106
		2100	31.5	66.2	6478	5633	98
BXRC-30C4001-B-7x	70	450	33.2	14.9	2993	2757	200
		600	34.0	20.4	3926	3539	192
		900	34.8	31.3	5575	5017	178
		1350	35.6	48.1	8292	7041	172
		1800	36.1	65.1	10670	8815	164
BXRC-30C4001-C-7x	70	585	33.2	19.4	3787	3584	195
		780	34.0	26.5	4962	4601	187
		1170	34.8	40.7	7247	6523	178
		1755	35.6	62.5	10426	9154	167
		2340	36.1	84.6	13374	11460	158
BXRC-30C4001-D-7x	70	525	27.7	14.6	2887	2680	198
		700	28.2	19.8	3755	3441	190
		1050	29.0	30.5	5420	4878	178
		1575	30.4	47.9	7742	6846	162
		2100	31.5	66.2	9855	8570	149
BXRC-30E4000-B-7x	80	450	33.2	14.9	2859	2569	191
		600	34.0	20.4	3750	3363	184
		900	34.8	31.3	5324	4792	170
		1350	35.6	48.1	7919	6977	165
		1800	36.1	65.1	10190	8858	157
BXRC-30E4000-C-7x	80	585	33.2	19.4	3617	3423	186
		780	34.0	26.5	4739	4392	179
		1170	34.8	40.7	6922	6230	170
		1755	35.6	62.5	9958	8764	159
		2340	36.1	84.6	12773	11009	151
BXRC-30E4000-D-7x	80	525	27.7	14.6	2758	2560	189
		700	28.2	19.8	3586	3286	181
		1050	29.0	30.5	5177	4659	170
		1575	30.4	47.9	7394	6538	154
		2100	31.5	66.2	9412	8185	142

Notes for Table 5:

1. Alternate drive currents are provided for reference only and are not a guarantee of performance.
2. Bridgelux maintains a ± 7% tolerance on flux measurements.
3. Typical stabilized DC performance values are provided as reference only and are not a guarantee of performance.

Performance at Commonly Used Drive Currents

Table 5: Product Performance at Commonly Used Drive Currents (Continued)

Part Number	CRI	Drive Current ¹ (mA)	Typical V _f T _c = 25°C (V)	Typical Power T _c = 25°C (W)	Typical Flux ² T _c = 25°C (lm)	Typical DC Flux ³ T _c = 85°C (lm)	Typical Efficacy T _c = 25°C (lm/W)
BXRC-30G40H0-B-7x	90	450	33.2	14.9	2321	2085	155
		600	34.0	20.4	3044	2730	149
		900	34.8	31.3	4322	3890	138
		1350	35.6	48.1	6428	5664	134
		1800	36.1	65.1	8272	7191	127
BXRC-30G40H0-C-7x	90	585	33.2	19.4	2936	2778	151
		780	34.0	26.5	3847	3565	145
		1170	34.8	40.7	5619	5057	138
		1755	35.6	62.5	8083	7115	129
		2340	36.1	84.6	10368	8937	123
BXRC-30G40H0-D-7x	90	525	27.7	14.6	2238	2078	154
		700	28.2	19.8	2911	2667	147
		1050	29.0	30.5	4202	3782	138
		1575	30.4	47.9	6002	5307	125
		2100	31.5	66.2	7641	6644	115
BXRC-30G4000-B-7x	90	450	33.2	14.9	2421	2176	162
		600	34.0	20.4	3176	2849	156
		900	34.8	31.3	4510	4059	144
		1350	35.6	48.1	6708	5910	139
		1800	36.1	65.1	8632	7503	133
BXRC-30G4000-C-7x	90	585	33.2	19.4	3063	2899	158
		780	34.0	26.5	4014	3720	151
		1170	34.8	40.7	5863	5277	144
		1755	35.6	62.5	8435	7424	135
		2340	36.1	84.6	10819	9325	128
BXRC-30G4000-D-7x	90	525	27.7	14.6	2336	2168	160
		700	28.2	19.8	3037	2783	154
		1050	29.0	30.5	4385	3946	144
		1575	30.4	47.9	6263	5538	131
		2100	31.5	66.2	7973	6933	120
BXRC-30G400C-B-7x	90	450	33.2	14.9	2236	2010	150
		600	34.0	20.4	2934	2631	144
		900	34.8	31.3	4166	3749	133
		1350	35.6	48.1	6195	5459	129
		1800	36.1	65.1	7972	6930	123
BXRC-30G400C-D-7x	90	525	27.7	14.6	2157	2002	148
		700	28.2	19.8	2805	2571	142
		1050	29.0	30.5	4050	3645	133
		1575	30.4	47.9	5785	5115	121
		2100	31.5	66.2	7364	6404	111
BXRC-30H4000-B-7x	97	450	33.2	14.9	2102	1936	141
		600	34.0	20.4	2757	2485	135
		900	34.8	31.3	3915	3524	125
		1350	35.6	48.1	5823	4945	121
		1800	36.1	65.1	7493	6190	115

Notes for Table 5:

1. Alternate drive currents are provided for reference only and are not a guarantee of performance.
2. Bridgelux maintains a ± 7% tolerance on flux measurements.
3. Typical stabilized DC performance values are provided as reference only and are not a guarantee of performance.

Performance at Commonly Used Drive Currents

Table 5: Product Performance at Commonly Used Drive Currents (Continued)

Part Number	CRI	Drive Current ¹ (mA)	Typical V _f T _c = 25°C (V)	Typical Power T _c = 25°C (W)	Typical Flux ² T _c = 25°C (lm)	Typical DC Flux ³ T _c = 85°C (lm)	Typical Efficacy T _c = 25°C (lm/W)
BXRC-30H4000-C-7x	97	585	33.2	19.4	2659	2517	137
		780	34.0	26.5	3485	3231	131
		1170	34.8	40.7	5090	4581	125
		1755	35.6	62.5	7322	6428	117
		2340	36.1	84.6	9392	8048	111
BXRC-30H4000-D-7x	97	525	27.7	14.6	2028	1882	139
		700	28.2	19.8	2637	2416	133
		1050	29.0	30.5	3806	3426	125
		1575	30.4	47.9	5437	4807	113
		2100	31.5	66.2	6921	6018	105
BXRC-30A4001-B-7x	93	450	33.3	15.0	2085	1874	139
		600	33.9	20.4	2735	2453	134
		900	35.0	31.2	3884	3495	124
		1350	36.7	49.5	5776	5089	117
		1800	38.0	68.4	7433	6461	109
BXRC-30A4001-C-7x	93	585	33.4	19.5	2638	2496	135
		780	34.0	26.5	3457	3203	130
		1170	35.0	40.6	5049	4544	124
		1755	36.8	64.5	7263	6393	113
		2340	38.1	89.3	9317	8030	104
BXRC-30A4001-D-7x	93	525	27.7	14.6	2011	1867	138
		700	28.2	19.8	2615	2397	132
		1050	29.0	30.4	3776	3398	124
		1575	30.4	47.9	5393	4769	113
		2100	31.5	66.2	6866	5970	104
BXRC-35E4000-B-7x	80	450	33.2	14.9	2926	2629	196
		600	34.0	20.4	3838	3443	188
		900	34.8	31.3	5450	4905	174
		1350	35.6	48.1	8105	7142	168
		1800	36.1	65.1	10430	9067	160
BXRC-35E4000-C-7x	80	585	33.2	19.4	3702	3503	191
		780	34.0	26.5	4851	4495	183
		1170	34.8	40.7	7085	6376	174
		1755	35.6	62.5	10192	8970	163
		2340	36.1	84.6	13073	11268	155
BXRC-35E4000-D-7x	80	525	27.7	14.6	2822	2620	194
		700	28.2	19.8	3670	3363	186
		1050	29.0	30.5	5298	4768	174
		1575	30.4	47.9	7568	6692	158
		2100	31.5	66.2	9634	8378	145
BXRC-35G4000-B-7x	90	450	33.2	14.9	2405	2161	161
		600	34.0	20.4	3154	2829	155
		900	34.8	31.3	4479	4031	143
		1350	35.6	48.1	6661	5869	138
		1800	36.1	65.1	8572	7451	132

Notes for Table 5:

1. Alternate drive currents are provided for reference only and are not a guarantee of performance.
2. Bridgelux maintains a ± 7% tolerance on flux measurements.
3. Typical stabilized DC performance values are provided as reference only and are not a guarantee of performance.

Performance at Commonly Used Drive Currents

Table 5: Product Performance at Commonly Used Drive Currents (Continued)

Part Number	CRI	Drive Current ¹ (mA)	Typical V _f T _c = 25°C (V)	Typical Power T _c = 25°C (W)	Typical Flux ² T _c = 25°C (lm)	Typical DC Flux ³ T _c = 85°C (lm)	Typical Efficacy T _c = 25°C (lm/W)
BXRC-35G4000-C-7x	90	585	33.2	19.4	3042	2879	157
		780	34.0	26.5	3986	3694	150
		1170	34.8	40.7	5822	5240	143
		1755	35.6	62.5	8376	7372	134
		2340	36.1	84.6	10744	9260	127
BXRC-35G4000-D-7x	90	525	27.7	14.6	2320	2153	159
		700	28.2	19.8	3016	2764	153
		1050	29.0	30.5	4354	3919	143
		1575	30.4	47.9	6220	5500	130
		2100	31.5	66.2	7918	6885	120
BXRC-35A4001-B-7x	80	450	33.2	14.9	2220	1995	149
		600	34.0	20.4	2912	2612	143
		900	34.8	31.3	4134	3721	132
		1350	35.6	48.1	6149	5418	128
		1800	36.1	65.1	7913	6878	122
BXRC-35A4001-C-7x	80	585	33.2	19.4	2808	2658	145
		780	34.0	26.5	3680	3410	139
		1170	34.8	40.7	5375	4837	132
		1755	35.6	62.5	7732	6805	124
		2340	36.1	84.6	9918	8548	117
BXRC-35A4001-D-7x	80	525	27.7	14.6	2141	1987	147
		700	28.2	19.8	2784	2552	141
		1050	29.0	30.5	4019	3617	132
		1575	30.4	47.9	5741	5077	120
		2100	31.5	66.2	7308	6355	110
BXRC-40C4001-B-7x	80	450	33.2	14.9	3077	2765	206
		600	34.0	20.4	4037	3621	198
		900	34.8	31.3	5732	5158	183
		1350	35.6	48.1	8525	7511	177
		1800	36.1	65.1	10970	9536	169
BXRC-40C4001-C-7x	80	585	33.2	19.4	3893	3684	200
		780	34.0	26.5	5102	4728	192
		1170	34.8	40.7	7451	6706	183
		1755	35.6	62.5	10719	9434	171
		2340	36.1	84.6	13750	11851	163
BXRC-40C4001-D-7x	80	525	27.7	14.6	2968	2755	204
		700	28.2	19.8	3860	3537	195
		1050	29.0	30.5	5572	5015	183
		1575	30.4	47.9	7959	7038	166
		2100	31.5	66.2	10132	8811	153
BXRC-40E4000-B-7x	80	450	33.2	14.9	2943	2644	197
		600	34.0	20.4	3860	3462	189
		900	34.8	31.3	5481	4933	175
		1350	35.6	48.1	8152	7183	169
		1800	36.1	65.1	10490	9119	161

Notes for Table 5:

1. Alternate drive currents are provided for reference only and are not a guarantee of performance.
2. Bridgelux maintains a ± 7% tolerance on flux measurements.
3. Typical stabilized DC performance values are provided as reference only and are not a guarantee of performance.

Performance at Commonly Used Drive Currents

Table 5: Product Performance at Commonly Used Drive Currents (Continued)

Part Number	CRI	Drive Current ¹ (mA)	Typical V_f $T_c = 25^\circ\text{C}$ (V)	Typical Power $T_c = 25^\circ\text{C}$ (W)	Typical Flux ² $T_c = 25^\circ\text{C}$ (lm)	Typical DC Flux ³ $T_c = 85^\circ\text{C}$ (lm)	Typical Efficacy $T_c = 25^\circ\text{C}$ (lm/W)
BXRC-40E4000-C-7x	80	585	33.2	19.4	3723	3523	192
		780	34.0	26.5	4879	4521	184
		1170	34.8	40.7	7125	6413	175
		1755	35.6	62.5	10250	9022	164
		2340	36.1	84.6	13148	11333	155
BXRC-40E4000-D-7x	80	525	27.7	14.6	2839	2635	195
		700	28.2	19.8	3691	3383	187
		1050	29.0	30.5	5329	4796	175
		1575	30.4	47.9	7611	6730	159
		2100	31.5	66.2	9689	8426	146
BXRC-40G4000-B-7x	90	450	33.2	14.9	2455	2206	164
		600	34.0	20.4	3221	2889	158
		900	34.8	31.3	4573	4115	146
		1350	35.6	48.1	6801	5992	141
		1800	36.1	65.1	8752	7608	135
BXRC-40G4000-C-7x	90	585	33.2	19.4	3106	2939	160
		780	34.0	26.5	4070	3772	153
		1170	34.8	40.7	5945	5350	146
		1755	35.6	62.5	8552	7527	137
		2340	36.1	84.6	10970	9455	130
BXRC-40G4000-D-7x	90	525	27.7	14.6	2368	2198	163
		700	28.2	19.8	3080	2822	156
		1050	29.0	30.5	4446	4001	146
		1575	30.4	47.9	6350	5615	132
		2100	31.5	66.2	8084	7030	122
BXRC-40H4000-B-7x	97	450	33.2	14.9	2220	1995	149
		600	34.0	20.4	2912	2612	143
		900	34.8	31.3	4134	3721	132
		1350	35.6	48.1	6149	5418	128
		1800	36.1	65.1	7913	6878	122
BXRC-40H4000-C-7x	97	585	33.2	19.4	2808	2658	145
		780	34.0	26.5	3680	3410	139
		1170	34.8	40.7	5375	4837	132
		1755	35.6	62.5	7732	6805	124
		2340	36.1	84.6	9918	8548	117
BXRC-40H4000-D-7x	97	525	27.7	14.6	2141	1987	147
		700	28.2	19.8	2784	2552	141
		1050	29.0	30.5	4019	3617	132
		1575	30.4	47.9	5741	5077	120
		2100	31.5	66.2	7308	6355	110
BXRC-40A4001-B-7x	80	450	33.2	14.9	2405	2161	161
		600	34.0	20.4	3154	2829	155
		900	34.8	31.3	4479	4031	143
		1350	35.6	48.1	6661	5869	138
		1800	36.1	65.1	8572	7451	132

Notes for Table 5:

1. Alternate drive currents are provided for reference only and are not a guarantee of performance.
2. Bridgelux maintains a $\pm 7\%$ tolerance on flux measurements.
3. Typical stabilized DC performance values are provided as reference only and are not a guarantee of performance.

Performance at Commonly Used Drive Currents

Table 5: Product Performance at Commonly Used Drive Currents (Continued)

Part Number	CRI	Drive Current ¹ (mA)	Typical V _f T _c = 25°C (V)	Typical Power T _c = 25°C (W)	Typical Flux ² T _c = 25°C (lm)	Typical DC Flux ³ T _c = 85°C (lm)	Typical Efficacy T _c = 25°C (lm/W)
BXRC-40A4001-C-7x	80	585	33.2	19.4	3042	2879	157
		780	34.0	26.5	3986	3694	150
		1170	34.8	40.7	5822	5240	143
		1755	35.6	62.5	8376	7372	134
		2340	36.1	84.6	10744	9260	127
BXRC-40A4001-D-7x	80	525	27.7	14.6	2320	2153	159
		700	28.2	19.8	3016	2764	153
		1050	29.0	30.5	4354	3919	143
		1575	30.4	47.9	6220	5500	130
		2100	31.5	66.2	7918	6885	120
BXRC-50C4001-B-7x	70	450	33.2	14.9	3094	2780	207
		600	34.0	20.4	4059	3640	199
		900	34.8	31.3	5763	5187	184
		1350	35.6	48.1	8571	7552	178
		1800	36.1	65.1	11030	9588	170
BXRC-50C4001-C-7x	70	585	33.2	19.4	3914	3704	201
		780	34.0	26.5	5129	4753	193
		1170	34.8	40.7	7492	6743	184
		1755	35.6	62.5	10778	9486	172
		2340	36.1	84.6	13825	11915	163
BXRC-50C4001-D-7x	70	525	27.7	14.6	2985	2770	205
		700	28.2	19.8	3881	3557	196
		1050	29.0	30.5	5603	5043	184
		1575	30.4	47.9	8003	7077	167
		2100	31.5	66.2	10188	8859	154
BXRC-50E4001-B-7x	80	450	33.2	14.9	2976	2675	199
		600	34.0	20.4	3904	3502	191
		900	34.8	31.3	5544	4989	177
		1350	35.6	48.1	8245	7265	171
		1800	36.1	65.1	10610	9223	163
BXRC-50E4001-C-7x	80	585	33.2	19.4	3765	3563	194
		780	34.0	26.5	4934	4573	186
		1170	34.8	40.7	7207	6486	177
		1755	35.6	62.5	10368	9125	166
		2340	36.1	84.6	13299	11462	157
BXRC-50E4001-D-7x	80	525	27.7	14.6	2871	2665	197
		700	28.2	19.8	3733	3421	189
		1050	29.0	30.5	5390	4851	177
		1575	30.4	47.9	7698	6807	161
		2100	31.5	66.2	9800	8522	148
BXRC-50G4001-B-7x	90	450	33.2	14.9	2573	2312	172
		600	34.0	20.4	3375	3027	165
		900	34.8	31.3	4792	4313	153
		1350	35.6	48.1	7127	6280	148
		1800	36.1	65.1	9171	7972	141

Notes for Table 5:

1. Alternate drive currents are provided for reference only and are not a guarantee of performance.
2. Bridgelux maintains a ± 7% tolerance on flux measurements.
3. Typical stabilized DC performance values are provided as reference only and are not a guarantee of performance.

Performance at Commonly Used Drive Currents

Table 5: Product Performance at Commonly Used Drive Currents (Continued)

Part Number	CRI	Drive Current ¹ (mA)	Typical V _f T _c = 25°C (V)	Typical Power T _c = 25°C (W)	Typical Flux ² T _c = 25°C (lm)	Typical DC Flux ³ T _c = 85°C (lm)	Typical Efficacy T _c = 25°C (lm/W)
BXRC-50G4001-C-7x	90	585	33.2	19.4	3255	3080	168
		780	34.0	26.5	4265	3953	161
		1170	34.8	40.7	6230	5607	153
		1755	35.6	62.5	8962	7888	143
		2340	36.1	84.6	11496	9908	136
BXRC-50G4001-D-7x	90	525	27.7	14.6	2482	2304	170
		700	28.2	19.8	3227	2957	163
		1050	29.0	30.5	4659	4193	153
		1575	30.4	47.9	6654	5884	139
		2100	31.5	66.2	8471	7367	128
BXRC-56G4000-B-7x	90	450	33.2	14.9	2569	2385	172
		600	34.0	20.4	3341	3062	164
		900	34.8	31.3	4823	4341	154
		1350	35.6	48.1	6889	6092	143
		1800	36.1	65.1	8770	7627	135
BXRC-56G4000-C-7x	90	585	33.2	19.4	3340	3100	172
		780	34.0	26.5	4343	3980	164
		1170	34.8	40.7	6270	5643	154
		1755	35.6	62.5	8956	7920	143
		2340	36.1	84.6	11401	9915	135
BXRC-56G400x-D-7x	90	525	27.7	14.6	2498	2319	172
		700	28.2	19.8	3248	2977	164
		1050	29.0	30.5	4689	4220	154
		1575	30.4	47.9	6698	5923	140
		2100	31.5	66.2	8527	7415	129
BXRC-56H4000-D-7x	97	525	27.7	14.6	2255	2093	155
		700	28.2	19.8	2932	2687	148
		1050	29.0	30.5	4233	3809	139
		1575	30.4	47.9	6046	5346	126
		2100	31.5	66.2	7696	6693	116
BXRC-57C4001-B-7x	70	450	33.2	14.9	3010	2705	201
		600	34.0	20.4	3949	3541	194
		900	34.8	31.3	5606	5046	179
		1350	35.6	48.1	8338	7347	173
		1800	36.1	65.1	10730	9327	165
BXRC-57C4001-C-7x	70	585	33.2	19.4	3808	3604	196
		780	34.0	26.5	4990	4624	188
		1170	34.8	40.7	7288	6559	179
		1755	35.6	62.5	10485	9228	168
		2340	36.1	84.6	13449	11592	159
BXRC-57C4001-D-7x	70	525	27.7	14.6	2904	2695	199
		700	28.2	19.8	3776	3460	191
		1050	29.0	30.5	5451	4905	179
		1575	30.4	47.9	7785	6884	162
		2100	31.5	66.2	9911	8618	150

Notes for Table 5:

1. Alternate drive currents are provided for reference only and are not a guarantee of performance.
2. Bridgelux maintains a ± 7% tolerance on flux measurements.
3. Typical stabilized DC performance values are provided as reference only and are not a guarantee of performance.

Performance at Commonly Used Drive Currents

Table 5: Product Performance at Commonly Used Drive Currents (Continued)

Part Number	CRI	Drive Current ¹ (mA)	Typical V_f $T_c = 25^\circ\text{C}$ (V)	Typical Power $T_c = 25^\circ\text{C}$ (W)	Typical Flux ² $T_c = 25^\circ\text{C}$ (lm)	Typical DC Flux ³ $T_c = 85^\circ\text{C}$ (lm)	Typical Efficacy $T_c = 25^\circ\text{C}$ (lm/W)
BXRC-57E4001-B-7x	80	450	33.2	14.9	2859	2569	191
		600	34.0	20.4	3750	3363	184
		900	34.8	31.3	5324	4792	170
		1350	35.6	48.1	7919	6977	165
		1800	36.1	65.1	10190	8858	157
BXRC-57E4001-C-7x	80	585	33.2	19.4	3617	3423	186
		780	34.0	26.5	4739	4392	179
		1170	34.8	40.7	6922	6230	170
		1755	35.6	62.5	9958	8764	159
		2340	36.1	84.6	12773	11009	151
BXRC-57E4001-D-7x	80	525	27.7	14.6	2758	2560	189
		700	28.2	19.8	3586	3286	181
		1050	29.0	30.5	5177	4659	170
		1575	30.4	47.9	7394	6538	154
		2100	31.5	66.2	9412	8185	142
BXRC-65C4001-B-7x	70	450	33.2	14.9	3010	2705	201
		600	34.0	20.4	3949	3541	194
		900	34.8	31.3	5606	5046	179
		1350	35.6	48.1	8338	7347	173
		1800	36.1	65.1	10730	9327	165
BXRC-65C4001-C-7x	70	585	33.2	19.4	3808	3604	196
		780	34.0	26.5	4990	4624	188
		1170	34.8	40.7	7288	6559	179
		1755	35.6	62.5	10485	9228	168
		2340	36.1	84.6	13449	11592	159
BXRC-65C4001-D-7x	70	525	27.7	14.6	2904	2695	199
		700	28.2	19.8	3776	3460	191
		1050	29.0	30.5	5451	4905	179
		1575	30.4	47.9	7785	6884	162
		2100	31.5	66.2	9911	8618	150
BXRC-65E4001-B-7x	80	450	33.2	14.9	2892	2599	194
		600	34.0	20.4	3794	3403	186
		900	34.8	31.3	5387	4848	172
		1350	35.6	48.1	8012	7059	167
		1800	36.1	65.1	10310	8962	158
BXRC-65E4001-C-7x	80	585	33.2	19.4	3659	3463	188
		780	34.0	26.5	4795	4443	181
		1170	34.8	40.7	7003	6303	172
		1755	35.6	62.5	10075	8867	161
		2340	36.1	84.6	12923	11138	153
BXRC-65E4001-D-7x	80	525	27.7	14.6	2790	2590	192
		700	28.2	19.8	3628	3325	184
		1050	29.0	30.5	5237	4714	172
		1575	30.4	47.9	7481	6615	156
		2100	31.5	66.2	9523	8281	144

Notes for Table 5:

1. Alternate drive currents are provided for reference only and are not a guarantee of performance.
2. Bridgelux maintains a $\pm 7\%$ tolerance on flux measurements.
3. Typical stabilized DC performance values are provided as reference only and are not a guarantee of performance.

Electrical Characteristics

Table 6: Electrical Characteristics

Part Number	Drive Current (mA)	Forward Voltage Pulsed, $T_c = 25^\circ\text{C}$ (V) ^{1, 2, 3, 8}			Typical Coefficient of Forward Voltage ⁴ $\Delta V_f / \Delta T_c$ (mV/ $^\circ\text{C}$)	Typical Thermal Resistance Junction to Case ^{5,6} R_{j-c} ($^\circ\text{C}/\text{W}$)	Driver Selection Voltages ⁷ (V)	
		Minimum	Typical	Maximum			V_f Min. Hot $T_c = 105^\circ\text{C}$ (V)	V_f Max. Cold $T_c = -40^\circ\text{C}$ (V)
BXRC-xxx400x-B-7x	900	32.2	34.8	37.4	-14.9	0.15	31.0	38.4
	1800	33.4	36.1	38.8	-14.9	0.19	32.2	39.8
BXRC-xxx400x-C-7x	1170	32.2	34.8	37.4	-14.9	0.11	31.0	38.4
	2340	33.4	36.1	38.8	-14.9	0.13	32.2	39.8
BXRC-xxx400x-D-7x	1050	26.8	29.0	31.2	-12.2	0.16	25.8	32.0
	2100	29.2	31.5	33.9	-12.2	0.19	28.2	34.7

Notes for Table 6:

- Parts are tested in pulsed conditions. $T_c = 25^\circ\text{C}$. Pulse width is 10ms.
- Voltage minimum and maximum are provided for reference only and are not a guarantee of performance.
- Bridgelux maintains a tester tolerance of $\pm 0.10\text{V}$ on forward voltage measurements.
- Typical coefficient of forward voltage tolerance is $\pm 0.1\text{mV}$ for nominal current.
- Thermal resistance values are based from test data of a 3000K 80 CRI product.
- Thermal resistance value was calculated using total electrical input power; optical power was not subtracted from input power. The thermal interface material used during testing is not included in the thermal resistance value.
- V_f min hot and max cold values are provided as reference only and are not guaranteed by test. These values are provided to aid in driver design and selection over the operating range of the product.
- This product has been designed and manufactured per IEC 62031:2018. This product has passed dielectric withstand voltage testing at 1160 V. The working voltage designated for the insulation is 80V d.c. The maximum allowable voltage across the array must be determined in the end product application.

Eye Safety

Table 7: Eye Safety Risk Group (RG) Classifications

Part Number	Drive Current ⁵ (mA)	CCT ¹⁻⁵			
		2700K/3000K	4000K ²	5000K ³	6500K ⁴
BXRC-xxx400x-B-7x	900	RG1	RG1	RG1	RG1
	1350	RG1	RG1	RG1	RG2
	1800	RG1	RG1	RG2	RG2
BXRC-xxx400x-C-7x	1170	RG1	RG1	RG1	RG1
	1755	RG1	RG1	RG2	RG2
	2340	RG1	RG1	RG2	RG2
BXRC-xxx400x-D-7x	1050	RG1	RG1	RG1	RG1
	1575	RG1	RG1	RG1	RG2
	2100	RG1	RG1	RG2	RG2

Notes for Table 7:

1. Eye safety classification for the use of Bridgelux Vero Series LED arrays is in accordance with specification IEC/TR 62778: Application of IEC 62471 for the assessment of blue light hazard to light sources and luminaires.
2. For products classified as RG2 at 4000K, $E_{thr} = 1847.5$ lx.
3. For products classified as RG2 at 5000K, $E_{thr} = 1315.8$ lx.
4. For products classified as RG2 at 6500K, $E_{thr} = 1124.5$ lx.
5. Please contact your Bridgelux sales representative for E_{thr} values at specific drive currents and CCTs not listed.

Absolute Maximum Ratings

Table 8: Maximum Ratings

Parameter	Maximum Rating		
LED Junction Temperature (T_j)	150°C		
Storage Temperature	-40°C to +105°C		
Operating Case Temperature ¹ (T_c)	105°C		
Soldering Temperature ²	300°C or lower for a maximum of 6 seconds		
	BXRC-xxx400x-B-7x	BXRC-xxx400x-C-7x	BXRC-xxx400x-D-7x
Maximum Drive Current ³	1800mA	2340mA	2100mA
Maximum Peak Pulsed Drive Current ⁴	2570mA	3340mA	3000mA
Maximum Reverse Voltage ⁵	-60V	-60V	-50V

Notes for Table 8:

1. For IEC 62717 requirement, please consult your Bridgelux sales representative.
2. Refer to Bridgelux Application Note AN31: Assembly Considerations for Bridgelux Vero LED Arrays.
3. Arrays may be driven at higher currents however lumen maintenance may be reduced.
4. Bridgelux recommends a maximum duty cycle of 10% and pulse width of 20 ms when operating LED Arrays at maximum peak pulsed current specified. Maximum peak pulsed currents indicate values where LED Arrays can be driven without catastrophic failures.
5. Light emitting diodes are not designed to be driven in reverse voltage and will not produce light under this condition. Maximum rating provided for reference only.

Performance Curves

Figure 1: Vero 18B Drive Current vs. Voltage

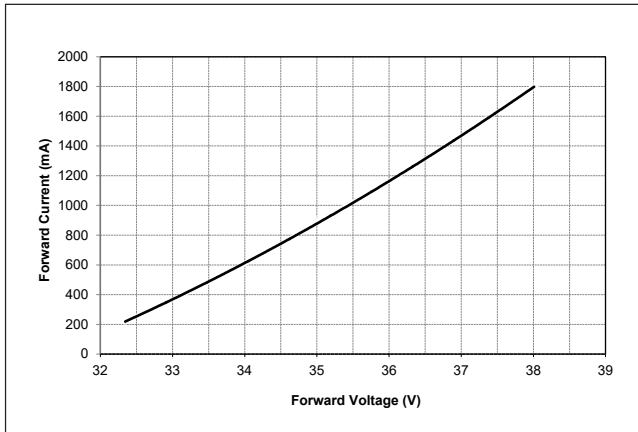

Figure 2: Vero 18C Drive Current vs. Voltage

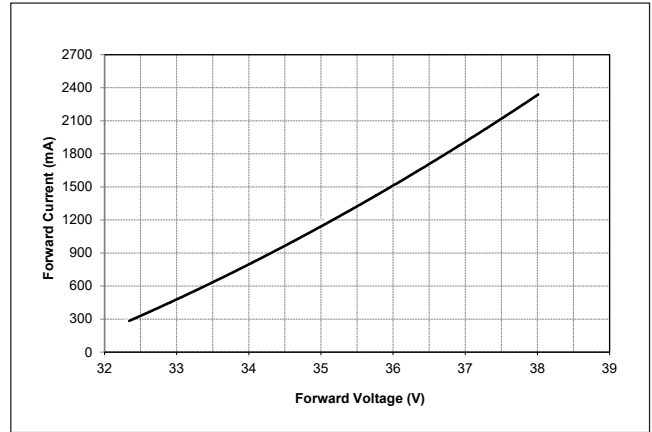

Figure 3: Vero 18D Drive Current vs. Voltage

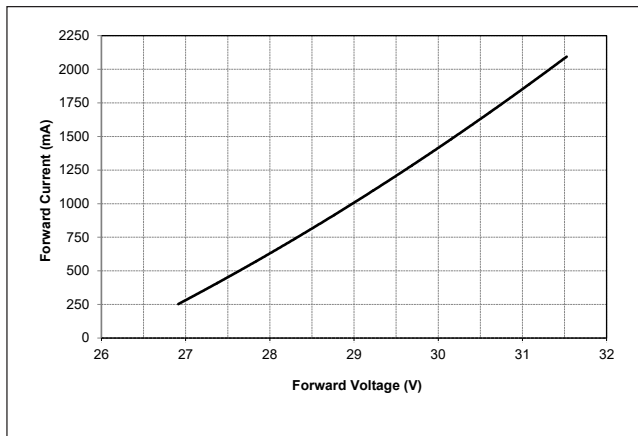

Figure 4: Vero 18B Typical Relative Flux vs. Current

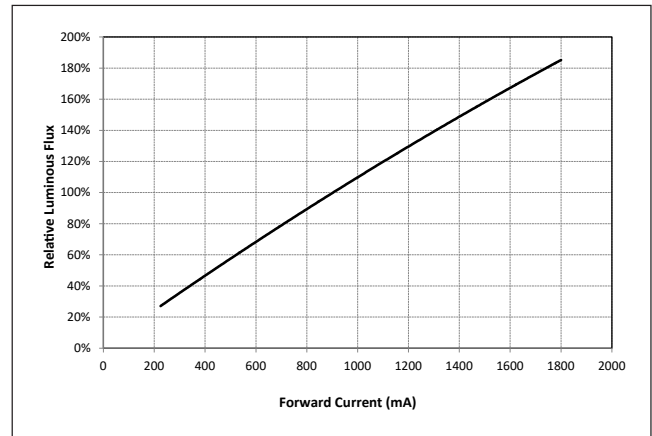

Figure 5: Vero 18C Typical Relative Flux vs. Current

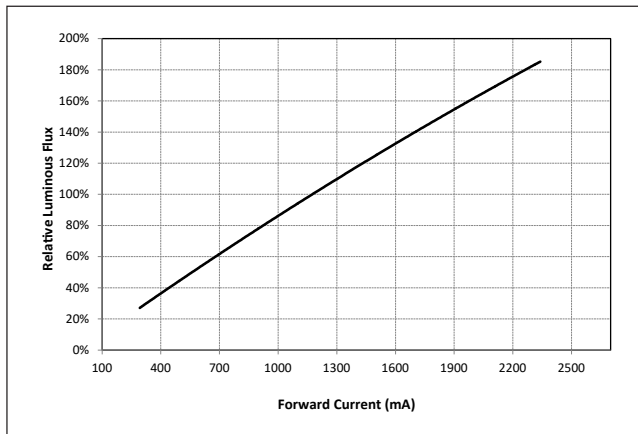
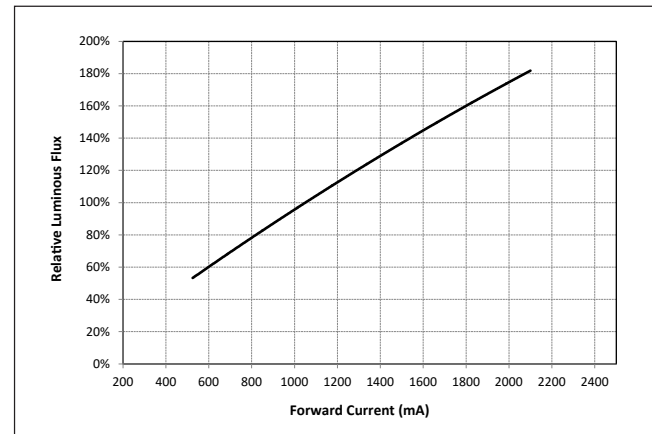

Figure 6: Vero 18D Typical Relative Flux vs. Current



Notes for Figures 1-6:

1. Bridgelux does not recommend driving high power LEDs at low currents. Doing so may produce unpredictable results. Pulse width modulation (PWM) is recommended for dimming effects.
2. Products tested under pulsed condition (10ms pulse width) at nominal test current where T_j (junction temperature) = T_c (case temperature) = 25°C.

Performance Curves

Figure 7: Typical DC Flux vs. Case Temperature

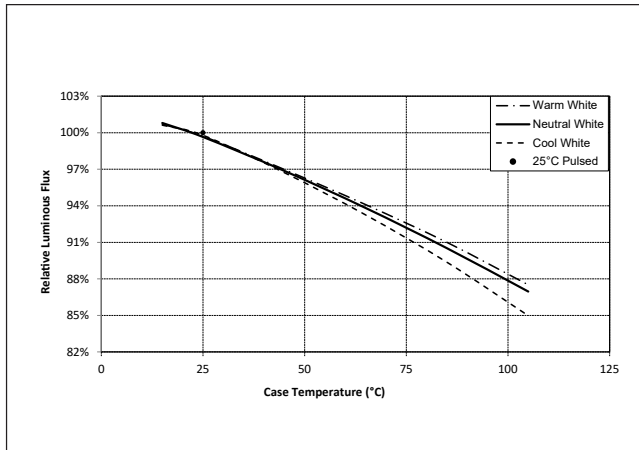

Figure 8: Typical DC ccy Shift vs. Case Temperature

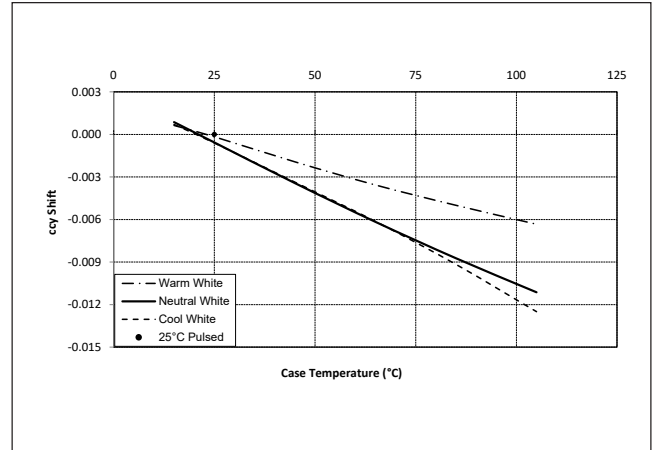
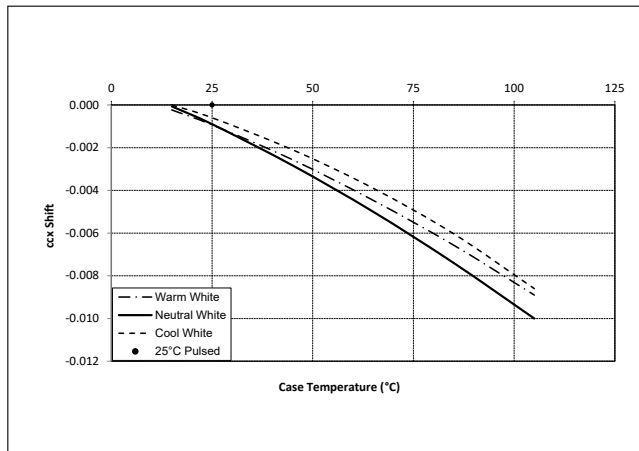

Figure 9: Typical DC ccx Shift vs. Case Temperature



Notes for Figures 7-9:

1. Characteristics shown for warm white based on 3000K and 80 CRI.
2. Characteristics shown for neutral white based on 4000K and 80 CRI.
3. Characteristics shown for cool white based on 5000K and 70 CRI.
4. For other color SKUs, the shift in color will vary. Please contact your Bridgelux Sales Representative for more information.

Performance Curves

Figure 10: 1750K Color Shift vs. Case Temperature¹

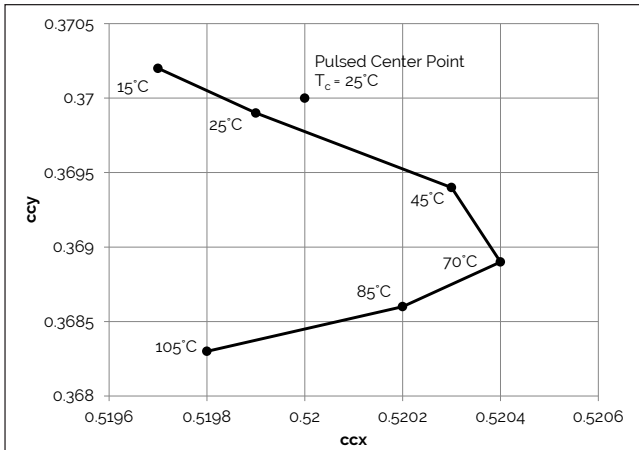

Figure 11: 2000K, 65 CRI Color Shift vs. Case Temperature

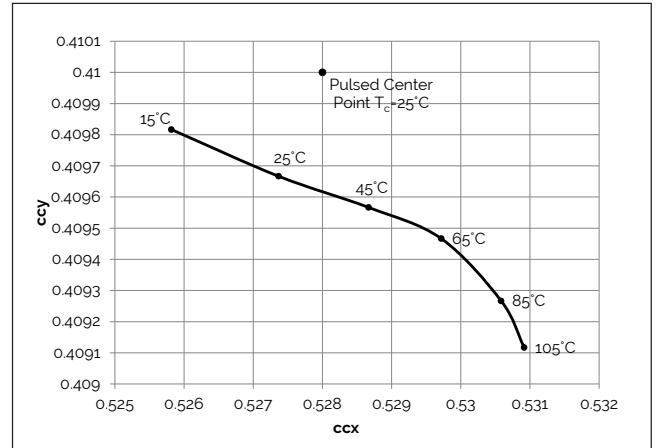

Figure 12: 2500K Color Shift vs. Case Temperature¹

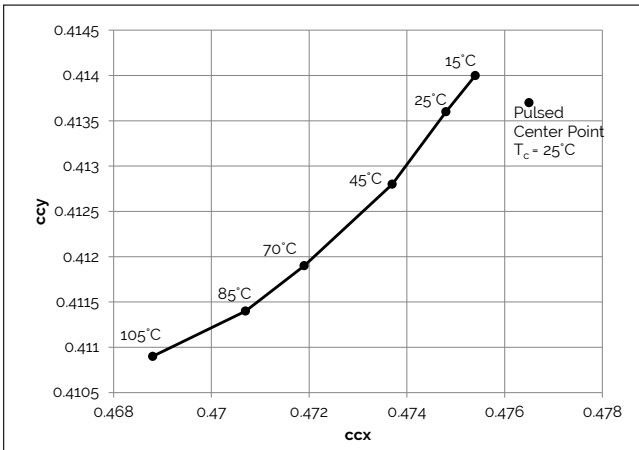

Figure 13: 3000K, 90 CRI Color Shift vs. Case Temperature^{1,3}

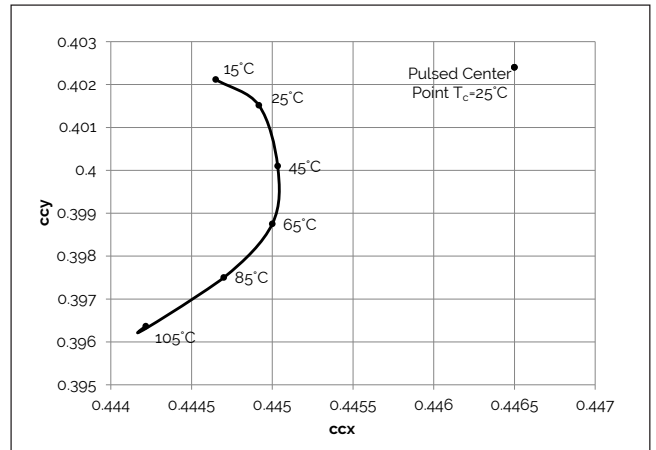

Figure 14: 2700K, 97 CRI Color Shift vs. Case Temperature¹

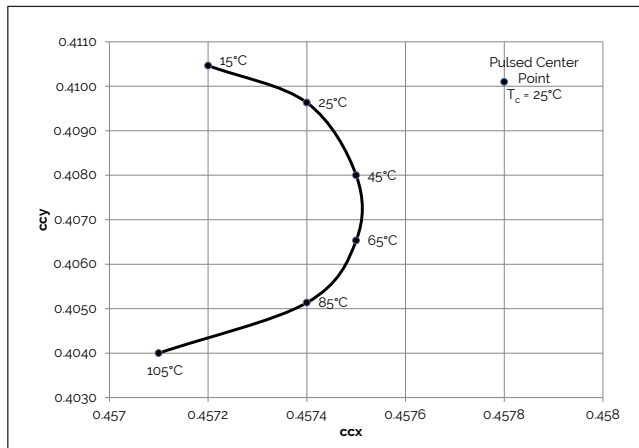
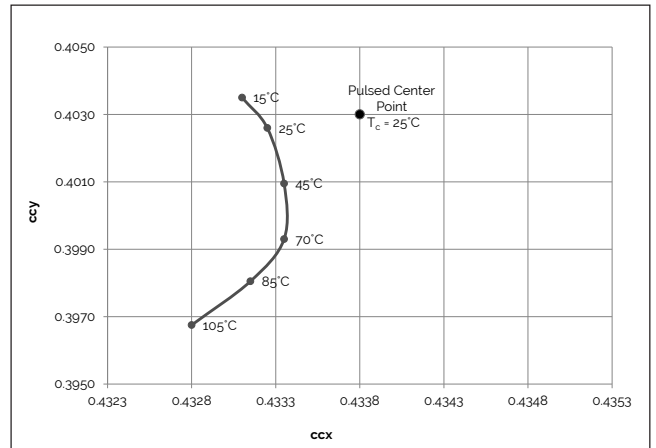

Figure 15: 3000K, 97 CRI Color Shift vs. Case Temperature¹



Notes for Figures 10-15:

1. Measurements made under DC test conditions at the nominal drive current.
2. Typical color shift is shown with a tolerance of ± 0.002 .
3. Characteristics shown for Decor Series Showcase products, BXRC-30G400C-x-73

Performance Curves

Figure 16: 5600K Color Shift vs. Case Temperature^{1,3}

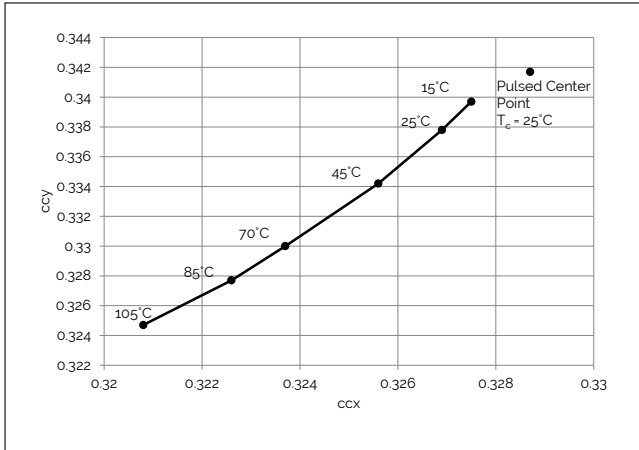

Figure 17: 3000K Class A Color Shift vs. Case Temperature¹

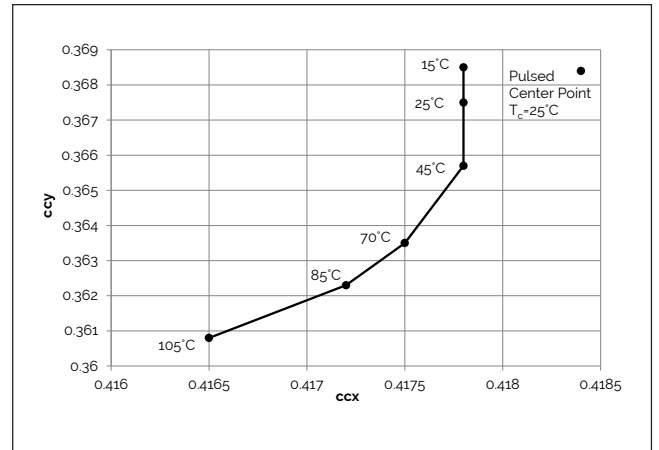

Figure 18: 3500K Class A Color Shift vs. Case Temperature¹

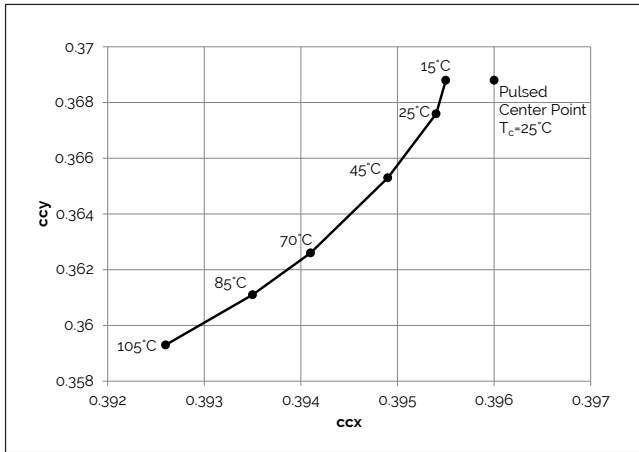
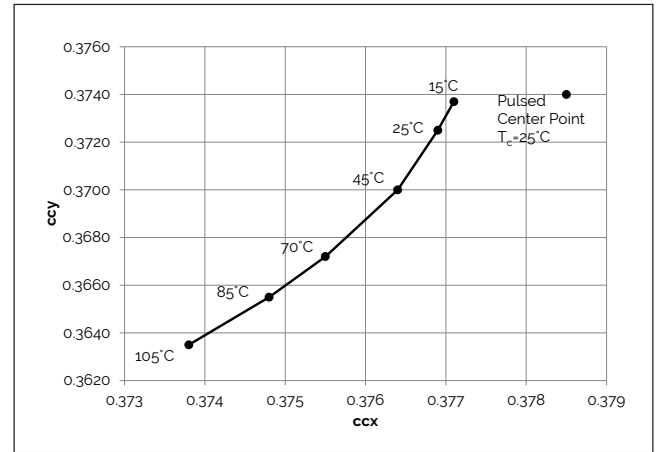

Figure 19: 4000K Class A Color Shift vs. Case Temperature¹



Notes for Figures 16-19:

1. Measurements made under DC test conditions at the nominal drive current.
2. Typical color shift is shown with a tolerance of ± 0.002 .
3. Color shift shown for product hot targeted at $T_c = 85^\circ\text{C}$

Typical Radiation Pattern

Figure 20: Typical Spatial Radiation Pattern

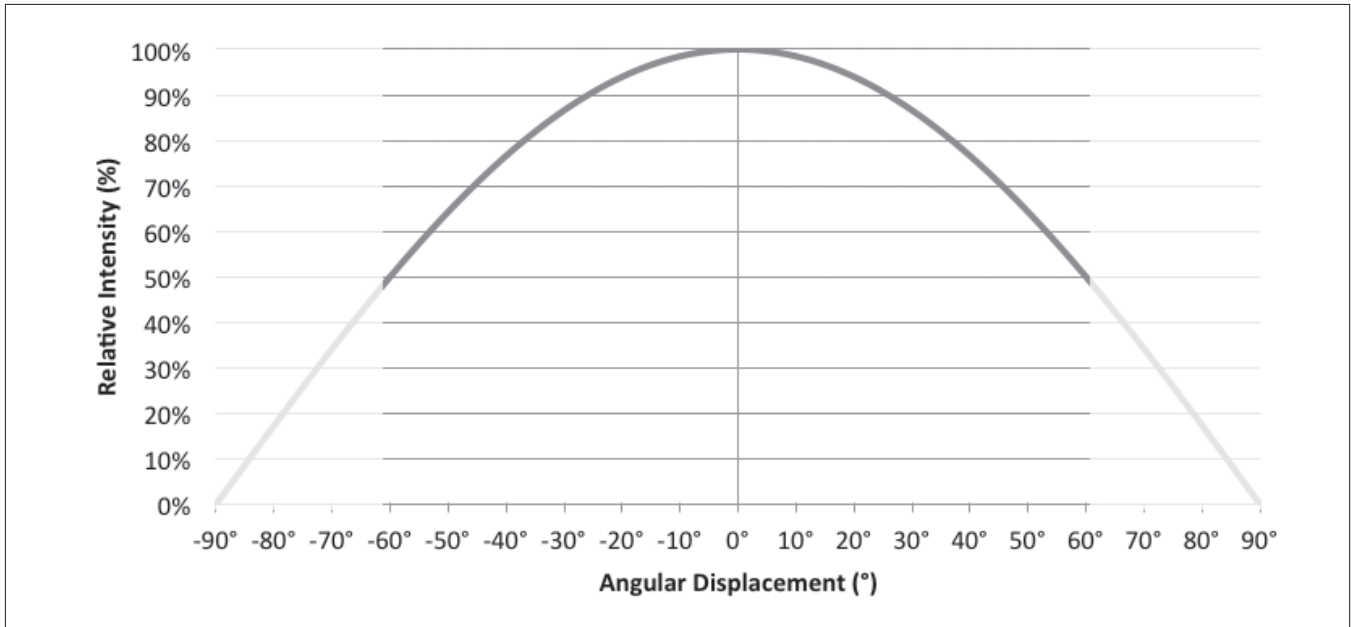

Notes for Figure 20:

1. Typical viewing angle is 120°.
2. The viewing angle is defined as the off axis angle from the centerline where intensity is ½ of the peak value.

Figure 21: Typical Polar Radiation Pattern

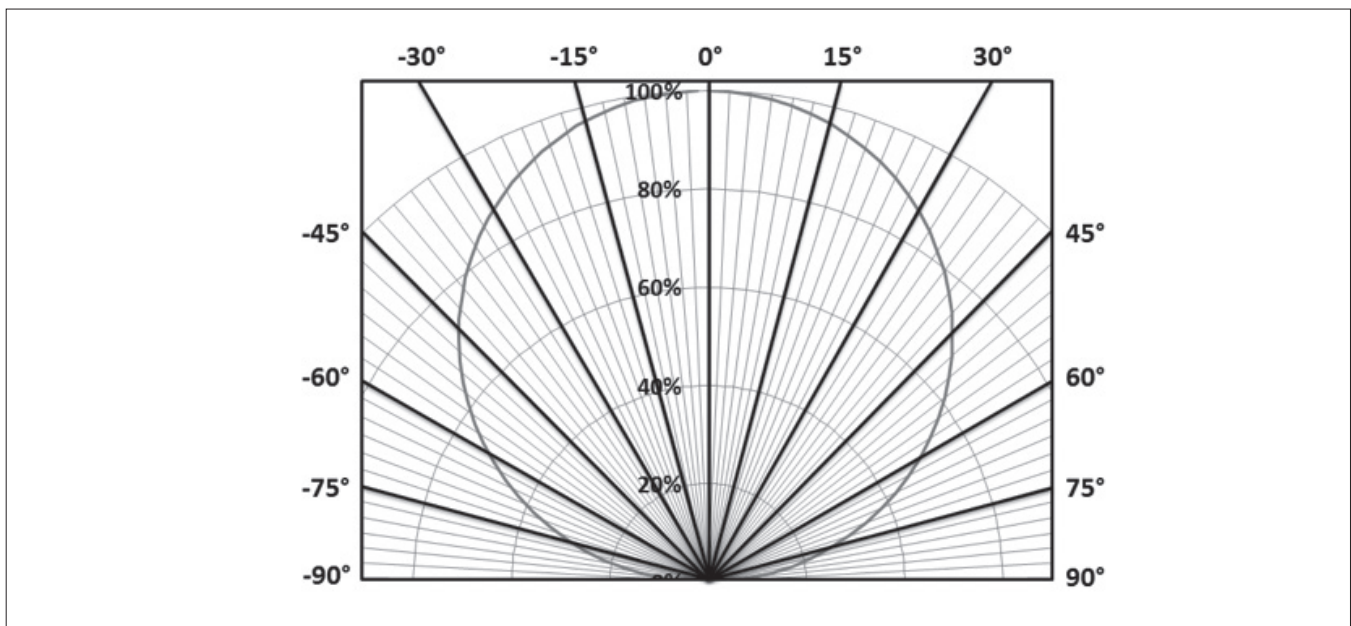

Typical Color Spectrum

Figure 22: Typical Color Spectrum

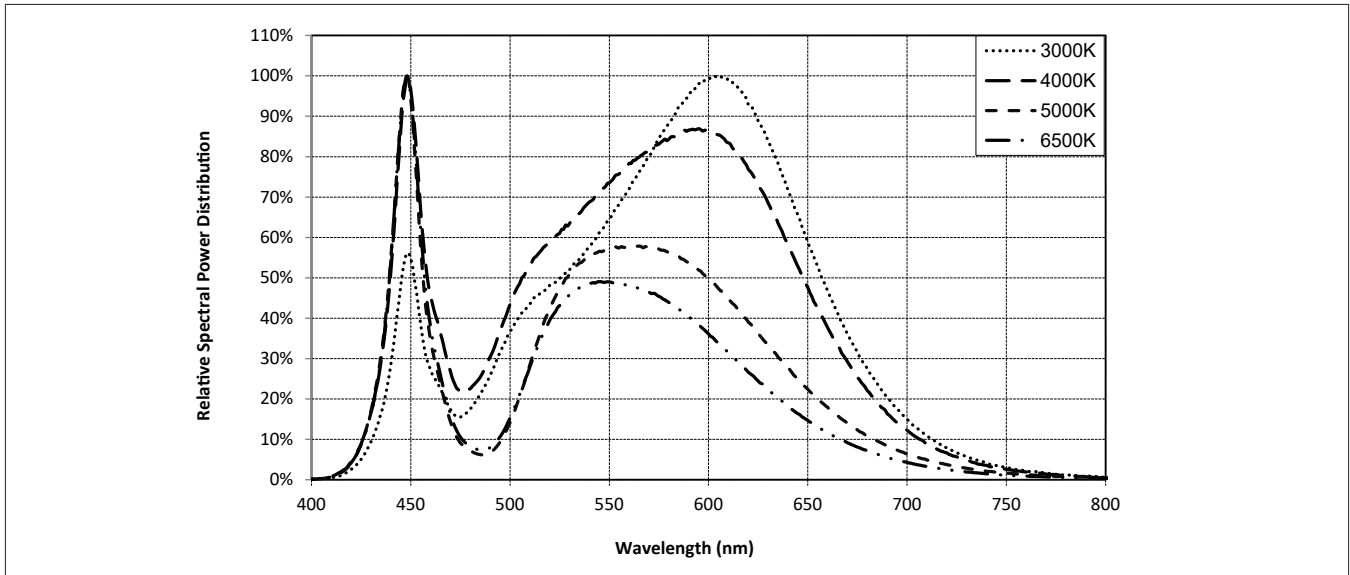

Notes for Figure 22:

1. Color spectra measured at nominal current for $T_j = T_c = 25^\circ\text{C}$.
2. Color spectra shown is 3000K and 80 CRI.
3. Color spectra shown is 4000K and 80 CRI.
4. Color spectra shown is 5000K and 70 CRI.
4. Color spectra shown is 6500K and 70 CRI.

Figure 23: Typical Color Spectrum for Vero 18 with Décor Series

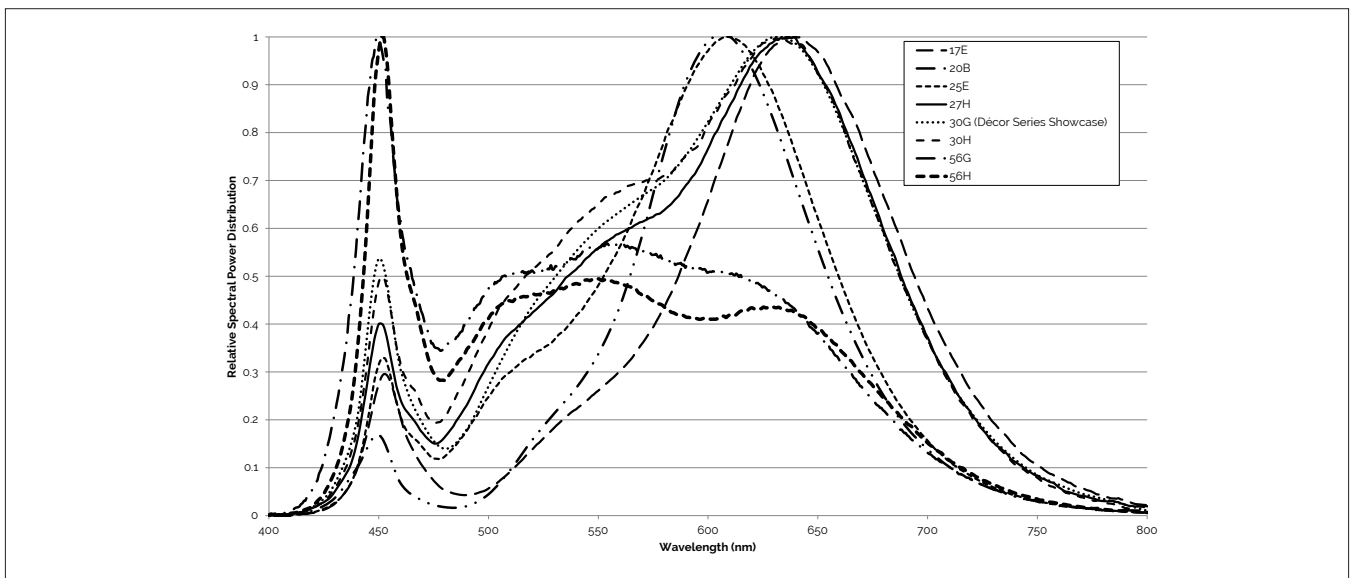

Note for Figure 23:

1. Color spectra measured at nominal current for $T_j = T_c = 25^\circ\text{C}$.

Mechanical Dimensions

Figure 24: Drawing for Vero 18 LED Array

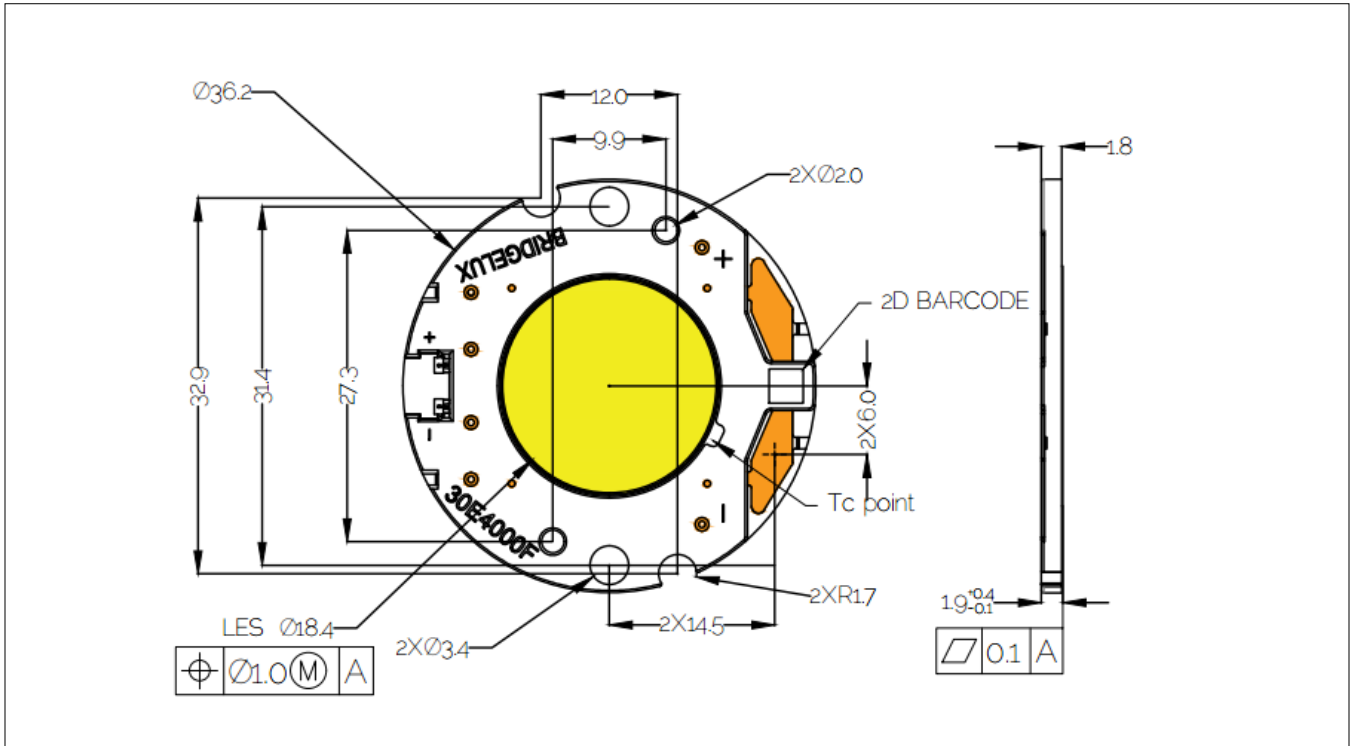

Notes for Figure 24:

1. Drawings are not to scale.
2. Drawing dimensions are in millimeters.
3. Unless otherwise specified, tolerances are $\pm 0.1\text{mm}$.
4. Mounting holes (2X) are for M2.5 screws.
5. Bridgelux recommends two tapped holes for mounting screws with $31.4 \pm 0.10\text{mm}$ center-to-center spacing.
6. Screws with flat shoulders (pan, dome, button, round, truss, mushroom) provide optimal torque control. Do NOT use flat, countersink, or raised head screws.
7. Solder pads and connector port are labeled "+" and "-" to denote positive and negative, respectively.
8. It is not necessary to provide electrical connections to both the solder pads and the connector port. Either set may be used depending on application specific design requirements.
9. Refer to Application Notes AN30 and AN31 for product handling, mounting and heat sink recommendations.
10. The optical center of the LED Array is nominally defined by the mechanical center of the array to a tolerance of $\pm 0.2\text{mm}$.
11. Bridgelux maintains a flatness of 0.10mm across the mounting surface of the array.

Color Binning Information

Figure 25: Warm and Neutral White Test Bins in xy Color Space

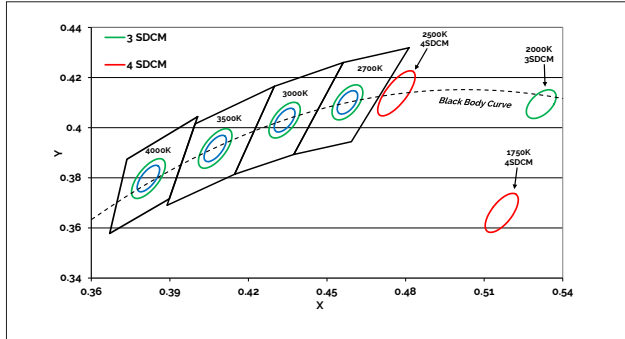

Note: Pulsed Test Conditions, $T_c = 25^\circ\text{C}$

Table 9: Warm and Neutral White xy Bin Coordinates and Associated Typical CCT

Bin Code	1750K	2000K	2500K	2700K	3000K ¹	3500K ¹	4000K ²
ANSI Bin (for reference only)	-	-	-	(2580K - 2870K)	(2870K - 3220K)	(3220K - 3710K)	(3710K - 4260K)
73 (3 SDCM)	-	-	-	(2651K - 2794K)	(2968K - 3136K)	(3369K - 3586K)	(3851K - 4130K)
72 (2 SDCM)	-	-	-	(2674K - 2769K)	(2995K - 3107K)	(3404K - 3548K)	(3895K - 4081K)
Center Point (x,y)	(0.5167, 0.336)	(0.5280, 0.4100)	(0.4765, 0.4137)	(0.4578, 0.4101)	(0.4338, 0.403) (0.4465, 0.4024) ²	(0.4073, 0.3917)	(0.3818, 0.3797)

Notes for Table 9:

- Color Binning information excludes Decor Series Class A products. Please contact your Bridgelux Sales Representative for more information.
- Center Point for Decor Series Showcase.
- Bridgelux maintains a tolerance of +/- 0.007 on x and y color coordinates in the CIE 1931 color Space.

Figure 26: Cool White Test Bins in xy Color Space

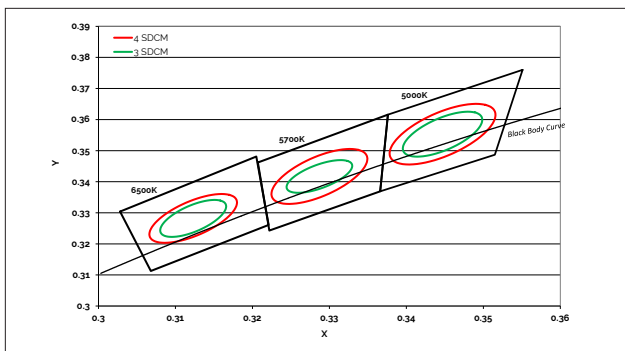

Note: Pulsed Test Conditions, $T_c = 25^\circ\text{C}$

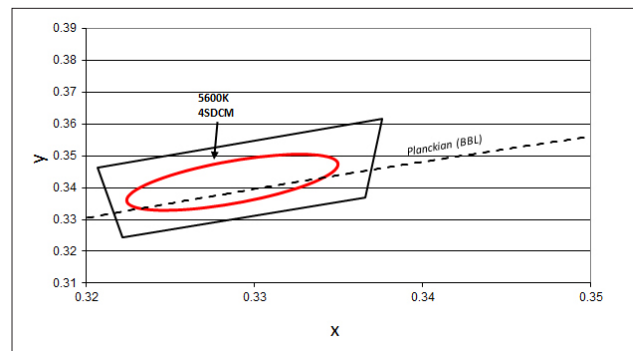

Note: Pulsed Test Conditions, $T_c = 25^\circ\text{C}$

Table 10: Cool White xy Bin Coordinates and Associated Typical CCT (product is hot targeted to $T_c = 85^\circ\text{C}$)

Bin Code	5000K	5600K	5700K	6500K
ANSI Bin (for reference only)	(4745K - 5311K)	(5310K - 6020K)	(5312K - 6022K)	(6022K - 7042K)
74 (4 SDCM)	(4801K - 5282K)	(5475K - 5830K)	(5395K - 5970K)	(6200K - 6910K)
73 (3 SDCM)	(4835K - 5215K)	(5490K - 5820K)	(5460K - 5891K)	(6279K - 6811K)
Center Point (x,y)	(0.3447, 0.3553)	(0.3293, 0.3423)	(0.3287, 0.3417)	(0.3123, 0.3282)

Notes for Table 10:

- Select configurations with a CCT of 5600K are available with center point targets at $T_c = 85^\circ\text{C}$ or $T_c = 25^\circ\text{C}$.
- Bridgelux maintains a tolerance of +/- 0.007 on x and y color coordinates in the CIE 1931 color Space.

Packaging and Labeling

Figure 27: Drawing for Vero 18 Packaging Tray

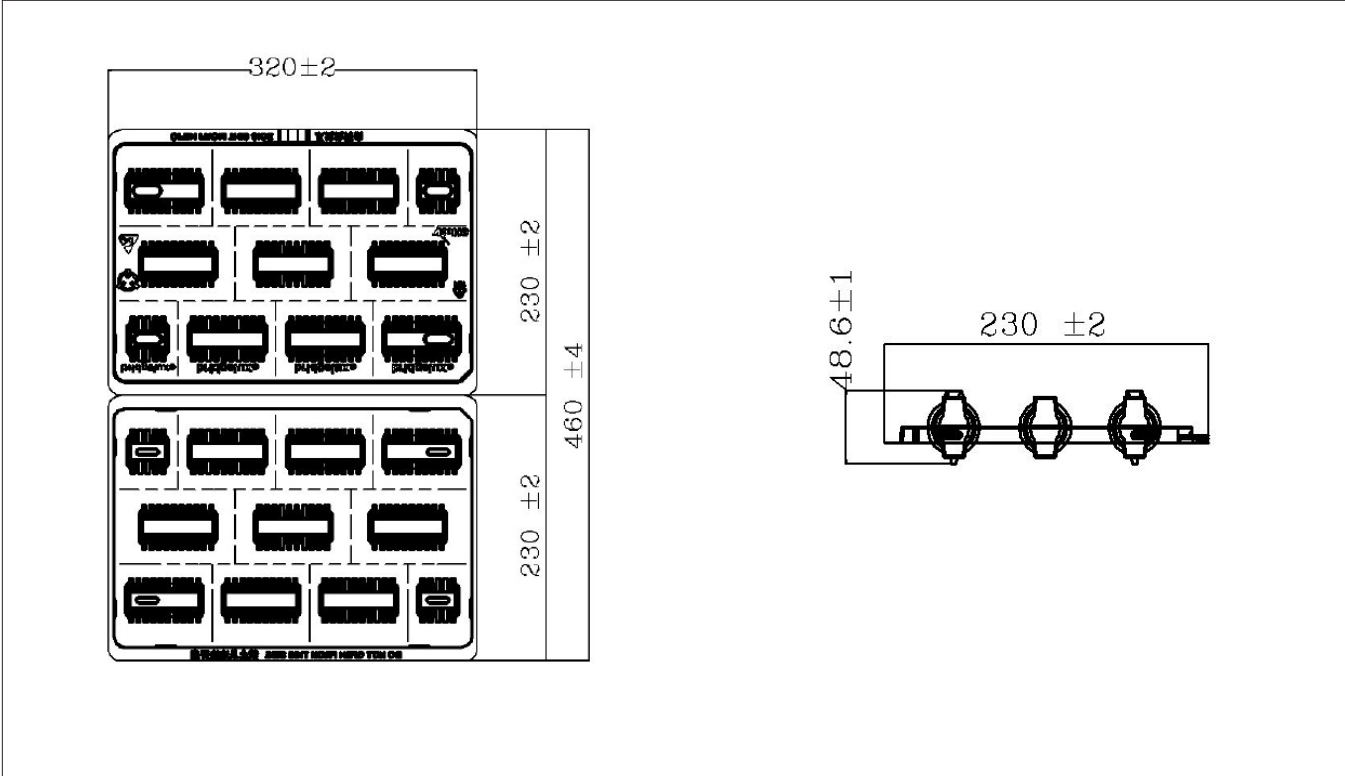

- Notes for Figure 27:
- 1. Dimensions are in millimeters.
 - 2. Drawings are not to scale.

Packaging and Labeling

Figure 28: Vero Series Packaging and Labeling

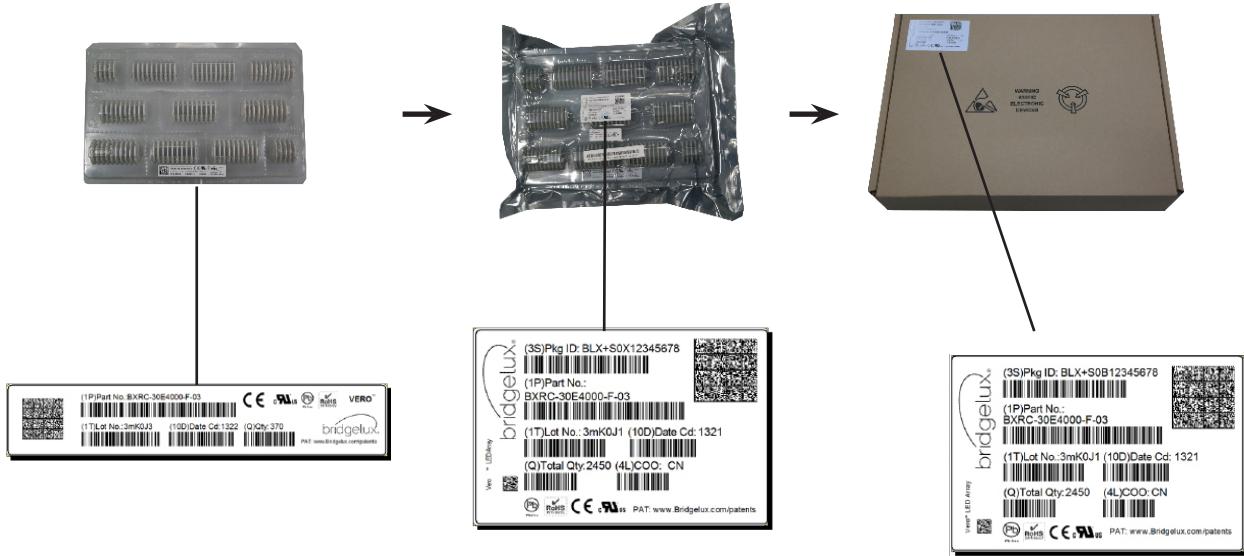

Notes for Figure 28:

1. Each tray holds 100 COBs.
2. Each tray is vacuum sealed in an anti-static bag and placed in its own box.
3. Each tray, bag and box is to be labeled as shown above.

Figure 29: Gen. 7 Product Labeling

Bridgelux COB arrays have laser markings on the back side of the substrate to help with product identification. In addition to the product identification markings, Bridgelux COB arrays also contain markings for internal Bridgelux manufacturing use only. The image below shows which markings are for customer use and which ones are for Bridgelux internal use only. The Bridgelux internal manufacturing markings are subject to change without notice, however these will not impact the form, function or performance of the COB array.



Customer Use- 2D Barcode
Scannable barcode provides product part number and other Bridgelux internal production information.

Customer Use- Product part number

30E4000C 73 2F

Customer Use- V_f Bin Code
included to enable greater luminaire design flexibility. Refer to ANG2 for bin code definitions.

Design Resources

Application Notes

Bridgelux has developed a comprehensive set of application notes and design resources to assist customers in successfully designing with the Vero product family of LED array products. For all available application notes visit www.bridgelux.com.

Optical Source Models

Optical source models and ray set files are available for all Bridgelux products. For a list of available formats, visit www.bridgelux.com.

3D CAD Models

Three dimensional CAD models depicting the product outline of all Bridgelux Vero LED arrays are available in both IGS and STEP formats. Please contact your Bridgelux sales representative for assistance.

LM80

LM80 testing has been completed and the LM80 report is now available. Please contact your Bridgelux sales representative for LM-80 report.

Precautions

CAUTION: CHEMICAL EXPOSURE HAZARD

Exposure to some chemicals commonly used in luminaire manufacturing and assembly can cause damage to the LED array. Please consult Bridgelux Application Note AN31 for additional information.

CAUTION: RISK OF BURN

Do not touch the Vero LED array during operation. Allow the array to cool for a sufficient period of time before handling. The Vero LED array may reach elevated temperatures such that could burn skin when touched.

CAUTION

CONTACT WITH LIGHT EMITTING SURFACE (LES)

Avoid any contact with the LES. Do not touch the LES of the LED array or apply stress to the LES (yellow phosphor resin area). Contact may cause damage to the LED array.

Optics and reflectors must not be mounted in contact with the LES (yellow phosphor resin area). Optical devices may be mounted on the top surface of the plastic housing of the Vero LED array. Use the mechanical features of the LED array housing, edges and/or mounting holes to locate and secure optical devices as needed.

Disclaimers

MINOR PRODUCT CHANGE POLICY

The rigorous qualification testing on products offered by Bridgelux provides performance assurance. Slight cosmetic changes that do not affect form, fit, or function may occur as Bridgelux continues product optimization.

STANDARD TEST CONDITIONS

Unless otherwise stated, array testing is performed at the nominal drive current.

About Bridgelux: Bridging Light and Life™

At Bridgelux, we help companies, industries and people experience the power and possibility of light. Since 2002, we've designed LED solutions that are high performing, energy efficient, cost effective and easy to integrate. Our focus is on light's impact on human behavior, delivering products that create better environments, experiences and returns—both experiential and financial. And our patented technology drives new platforms for commercial and industrial luminaires.

For more information about the company, please visit
bridgelux.com
twitter.com/Bridgelux
facebook.com/Bridgelux
youtube.com/user/Bridgelux
linkedin.com/company/bridgelux-inc-_2
WeChat ID: BridgeluxInChina



46410 Fremont Boulevard
Fremont, CA 94538 U.S.A.
Tel (925) 583-8400
www.bridgelux.com

© 2021 Bridgelux, Inc. All rights reserved. Product specifications are subject to change without notice. Bridgelux, the Bridgelux stylized logo design, Vero, V Series and V Series HD are registered trademarks, and Decor Series is a trademark of Bridgelux, Inc. All other trademarks are the property of their respective owners.

Bridgelux Gen 7 Vero 18 Array Series Product Data Sheet DSg2 Rev. Q (08/2021)