



Bridgelux® Gen 7 Vero® 13 Array

Product Data Sheet DSg1



Introduction

Vero® Series



Vero® Series is a revolutionary advancement in chip on board (COB) light source technology and innovation. Vero LED light sources simplify luminaire design and manufacturing processes. Vero Chip on Board (COB) LED arrays are available in four LES configurations, engineered to enable new degrees of flexibility and reliability over a broad range of electrical currents. Vero arrays deliver increased lumen density to enable improved beam control and precision lighting with 2 and 3 SDCM color control standard for clean and consistent uniform lighting.

Vero products include an onboard connector port that enables a solder-free electrical interconnect, and simple mounting features for plug-and-play installation.

Bridgelux Décor Series™ is our state-of-the-art color line designed specifically for premium applications, producing unmatched LED light quality with brilliant color-rendering options and pleasing lighting palettes. Bridgelux Décor Series color points are available on Vero® SE Series, Vero® Series, V Series™ and V Series™ HD.

Décor Series™ Class A is based on human response testing, providing color points with a combined GAI and CRI metric.

Décor Series™ Ultra products provide a high CRI of 97 and minimum R9 value of 93, which emphasizes the reds and color tones to which the human eye is most receptive - perfect for the most luxurious retail shops and world renowned museums. Décor Series Ultra is also designed as a replacement for halogen lamps.

Décor Series™ Showcase is the optimal solution for replacing ceramic metal halide lamps, incorporating the same pure white light with enhanced spectrum coverage and higher efficacy.

Features

- Efficacy of 170 lm/W typical
- Lumen output performance ranges from 460 to 7,300 lumens
- Broad range of CCT options from 2700K to 6500K
- CRI options include: minimum 70, 80, and 90
- 2 and 3 SDCM color control for 2700K-4000K CCT
- Reliable operation at up to 2X nominal drive current
- Radial die pattern and improved lumen density
- Thermally isolated solder pads
- Onboard connector port
- Top side part number markings
- V_f bin code backside marking

Benefits

- Broad application coverage for interior and exterior lighting
- Flexibility for application driven lighting design requirements
- High quality true color reproduction
- Uniform consistent white light
- Flexibility in design optimization
- Enhanced ease of use and assembly
- Solderless connectivity enables plug & play installation and field upgradability
- Improved inventory management and quality control



Contents

Product Feature Map	2
Product Nomenclature	2
Product Selection Guide	3
European Product Registry for Energy Labeling	4
Performance at Commonly Used Drive Currents	10
Electrical Characteristics	13
Eye Safety	22
Absolute Maximum Ratings	23
Performance Curves	24
Typical Radiation Pattern	28
Typical Color Spectrum	29
Mechanical Dimensions	30
Color Binning Information	31
Packaging and Labeling	32
Design Resources	34
Precautions	34
Disclaimers	34
About Bridgelux	35

Product Feature Map

Vero 13 is the second smallest form factor in the Vero family of the next generation solid state light sources. In addition to delivering the performance and light quality required for many lighting applications, Vero incorporates

several features to simplify the design integration and manufacturing process, accelerate time to market and reduce system costs. Please visit www.bridgelux.com for more information on the Vero Series family of products.

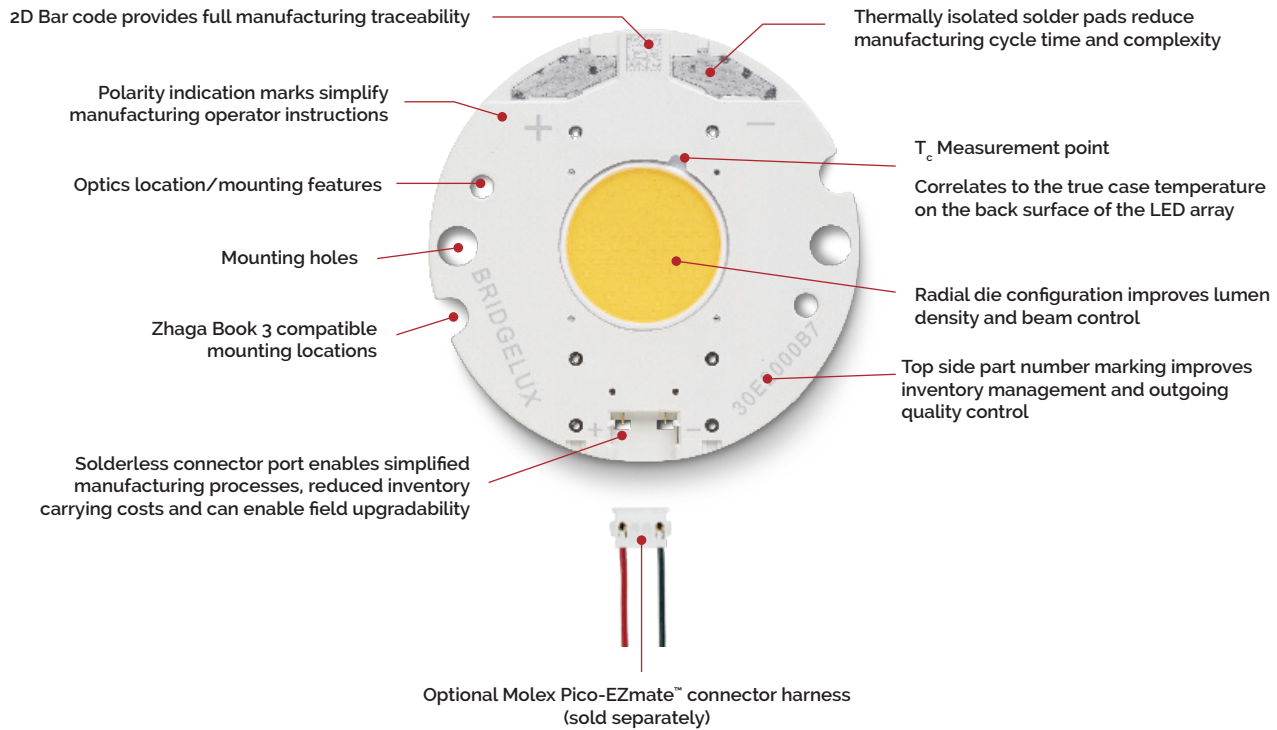

Product Nomenclature

The part number designation for Bridgelux Vero LED arrays is explained as follows:

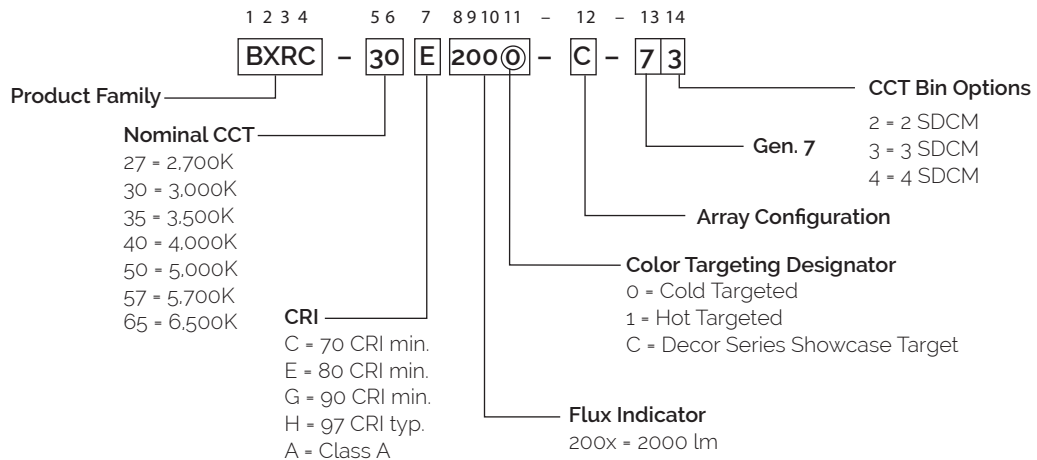

Product Selection Guide

The following product configurations are available:

Table 1: Selection Guide, Pulsed Measurement Data ($T_j = T_c = 25^\circ\text{C}$)

Part Number	Nominal CCT ¹ (K)	CRI ²	Nominal Drive Current ³ (mA)	Typical Pulsed Flux ^{4,5,6} $T_c = 25^\circ\text{C}$ (lm)	Minimum Pulsed Flux ^{6,7} $T_c = 25^\circ\text{C}$ (lm)	Typical V_f (V)	Typical Power (W)	Typical Efficacy (lm/W)
BXRC-27E2000-B-7x	2700	80	450	2506	2255	34.8	15.7	160
BXRC-27E2000-C-7x	2700	80	630	3508	3157	34.8	21.9	160
BXRC-27E2000-D-7x	2700	80	500	2544	2290	31.8	15.9	160
BXRC-27G20H0-B-7x	2700	90	450	2145	1931	34.8	15.7	137
BXRC-27G20H0-C-7x	2700	90	630	3004	2703	34.8	21.9	137
BXRC-27G20H0-D-7x	2700	90	500	2178	1960	31.8	15.9	137
BXRC-27G2000-B-7x	2700	90	450	2067	1860	34.8	15.7	132
BXRC-27G2000-C-7x	2700	90	630	2894	2605	34.8	21.9	132
BXRC-27G2000-D-7x	2700	90	500	2099	1889	31.8	15.9	132
BXRC-27H2000-B-7x	2700	97	450	1832	1649	34.8	15.7	117
BXRC-27H2000-C-7x	2700	97	630	2565	2309	34.8	21.9	117
BXRC-27H2000-D-7x	2700	97	500	1860	1674	31.8	15.9	117
BXRC-30C2001-B-7x	3000	70	450	2787	2509	34.8	15.7	178
BXRC-30C2001-C-7x	3000	70	630	3902	3512	34.8	21.9	178
BXRC-30C2001-D-7x	3000	70	500	2830	2547	31.8	15.9	178
BXRC-30E2000-B-7x	3000	80	450	2662	2396	34.8	15.7	170
BXRC-30E2000-C-7x	3000	80	630	3727	3354	34.8	21.9	170
BXRC-30E2000-D-7x	3000	80	500	2703	2433	31.8	15.9	170
BXRC-30G20H0-B-7x	3000	90	450	2255	2030	34.8	15.7	144
BXRC-30G20H0-C-7x	3000	90	630	3157	2841	34.8	21.9	144
BXRC-30G20H0-D-7x	3000	90	500	2290	2061	31.8	15.9	144
BXRC-30G2000-B-7x	3000	90	450	2161	1945	34.8	15.7	138
BXRC-30G2000-C-7x	3000	90	630	3026	2723	34.8	21.9	138
BXRC-30G2000-D-7x	3000	90	500	2194	1975	31.8	15.9	138
BXRC-30G200C-B-7x	3000	90	450	2095	1885	35.0	15.8	133
BXRC-30G200C-D-7x	3000	90	500	2115	1903	31.8	15.9	133
BXRC-30H2000-B-7x	3000	97	450	1958	1762	34.8	15.7	125
BXRC-30H2000-C-7x	3000	97	630	2741	2466	34.8	21.9	125
BXRC-30H2000-D-7x	3000	97	500	1988	1789	31.8	15.9	125
BXRC-30A2001-B-7x ^{8,9}	3000	93	450	1942	1748	34.8	15.7	124
BXRC-30A2001-C-7x ^{8,9}	3000	93	630	2719	2447	34.8	21.9	124
BXRC-30A2001-D-7x ^{8,9}	3000	93	500	1972	1774	31.8	15.9	124

Notes for Table 1:

- Nominal CCT as defined by ANSI C78.377-2011. Products with a CCT of 5000K-6500K are hot targeted to $T_c = 85^\circ\text{C}$.
- CRI values are typical for Decor Series Ultra, Decor Series Street and Landmark and Decor Series Class A products. CRI values are minimums for all other products. Minimum Rg value for 80 CRI products is 0, the minimum Rg value for 90 CRI products is 50, the minimum Rg value for 97 CRI products is 93. Bridgelux maintains a ± 3 tolerance on CRI and Rg values.
- Drive current is referred to as nominal drive current.
- Products tested under pulsed condition (10ms pulse width) at nominal test current where T_j (junction temperature) - T_c (case temperature) = 25°C .
- Typical performance values are provided as a reference only and are not a guarantee of performance.
- Bridgelux maintains a $\pm 7\%$ tolerance on flux measurements.
- Minimum flux values at the nominal test current are guaranteed by 100% test.
- Nominal CCT is defined by the Lighting Research Center's Class A definition. The center of the Class A color bin is on the corresponding isothermal line.
- GAI value is 80. To help ensure optimal fixture level performance, GAI is measured at the fixture level, on axis, at a case temperature of 70°C . GAI may vary depending on fixture design and performance.

Product Selection Guide

Table 1: Selection Guide, Pulsed Measurement Data ($T_j = T_c = 25^\circ\text{C}$) (continued)

Part Number	Nominal CCT ¹ (K)	CRI ²	Nominal Drive Current ³ (mA)	Typical Pulsed Flux ^{4,5,6} $T_c = 25^\circ\text{C}$ (lm)	Minimum Pulsed Flux ^{6,7} $T_c = 25^\circ\text{C}$ (lm)	Typical V_f (V)	Typical Power (W)	Typical Efficacy (lm/W)
BXRC-35E2000-B-7x	3500	80	450	2725	2452	34.8	15.7	174
BXRC-35E2000-C-7x	3500	80	630	3815	3433	34.8	21.9	174
BXRC-35E2000-D-7x	3500	80	500	2767	2490	31.8	15.9	174
BXRC-35G2000-B-7x	3500	90	450	2239	2015	34.8	15.7	143
BXRC-35G2000-C-7x	3500	90	630	3135	2822	34.8	21.9	143
BXRC-35G2000-D-7x	3500	90	500	2274	2046	31.8	15.9	143
BXRC-35A2001-B-7x ^{8,9}	3500	93	450	2067	1860	34.8	15.7	132
BXRC-35A2001-C-7x ^{8,9}	3500	93	630	2894	2605	34.8	21.9	132
BXRC-35A2001-D-7x ^{8,9}	3500	93	500	2099	1889	31.8	15.9	132
BXRC-40C2001-B-7x	4000	70	450	2866	2579	34.8	15.7	183
BXRC-40C2001-C-7x	4000	70	630	4012	3611	34.8	21.9	183
BXRC-40C2001-D-7x	4000	70	500	2910	2619	31.8	15.9	183
BXRC-40E2000-B-7x	4000	80	450	2741	2466	34.8	15.7	175
BXRC-40E2000-C-7x	4000	80	630	3837	3453	34.8	21.9	175
BXRC-40E2000-D-7x	4000	80	500	2783	2504	31.8	15.9	175
BXRC-40G2000-B-7x	4000	90	450	2286	2058	34.8	15.7	146
BXRC-40G2000-C-7x	4000	90	630	3201	2881	34.8	21.9	146
BXRC-40G2000-D-7x	4000	90	500	2321	2089	31.8	15.9	146
BXRC-40H2000-B-7x	4000	97	450	2067	1860	34.8	15.7	132
BXRC-40H2000-C-7x	4000	97	630	2894	2605	34.8	21.9	132
BXRC-40H2000-D-7x	4000	97	500	2099	1889	31.8	15.9	132
BXRC-40A2001-B-7x ^{8,9}	4000	93	450	2239	2015	34.8	15.7	143
BXRC-40A2001-C-7x ^{8,9}	4000	93	630	3135	2822	34.8	21.9	143
BXRC-40A2001-D-7x ^{8,9}	4000	93	500	2274	2046	31.8	15.9	143
BXRC-50C2001-B-7x	5000	70	450	2881	2593	34.8	15.7	184
BXRC-50C2001-C-7x	5000	70	630	4034	3631	34.8	21.9	184
BXRC-50C2001-D-7x	5000	70	500	2926	2633	31.8	15.9	184
BXRC-50E2001-B-7x	5000	80	450	2772	2495	34.8	15.7	177
BXRC-50E2001-C-7x	5000	80	630	3881	3492	34.8	21.9	177
BXRC-50E2001-D-7x	5000	80	500	2814	2533	31.8	15.9	177
BXRC-50G2001-B-7x	5000	90	450	2396	2156	34.8	15.7	153
BXRC-50G2001-C-7x	5000	90	630	3354	3019	34.8	21.9	153
BXRC-50G2001-D-7x	5000	90	500	2433	2189	31.8	15.9	153

Notes for Table 1:

- Nominal CCT as defined by ANSI C78.377-2011. Products with a CCT of 5000K-6500K are hot targeted to $T_c = 85^\circ\text{C}$.
- CRI values are typical for Decor Series Ultra, Decor Series Street and Landmark and Decor Series Class A products. CRI values are minimums for all other products. Minimum R_g value for 80 CRI products is 0, the minimum R_g value for 90 CRI products is 50, the minimum R_g value for 97 CRI products is 93. Bridgelux maintains a ± 3 tolerance on CRI and R_g values.
- Drive current is referred to as nominal drive current.
- Products tested under pulsed condition (10ms pulse width) at nominal test current where T_j (junction temperature) - T_c (case temperature) = 25°C .
- Typical performance values are provided as a reference only and are not a guarantee of performance.
- Bridgelux maintains a $\pm 7\%$ tolerance on flux measurements.
- Minimum flux values at the nominal test current are guaranteed by 100% test.
- Nominal CCT is defined by the Lighting Research Center's Class A definition. The center of the Class A color bin is on the corresponding isothermal line.
- GAI value is 80. To help ensure optimal fixture level performance, GAI is measured at the fixture level, on axis, at a case temperature of 70°C . GAI may vary depending on fixture design and performance.

Product Selection Guide

Table 1: Selection Guide, Pulsed Measurement Data ($T_j = T_c = 25^\circ\text{C}$) (continued)

Part Number	Nominal CCT ¹ (K)	CRI ²	Nominal Drive Current ³ (mA)	Typical Pulsed Flux ^{4,5,6} $T_c = 25^\circ\text{C}$ (lm)	Minimum Pulsed Flux ^{6,7} $T_c = 25^\circ\text{C}$ (lm)	Typical V_f (V)	Typical Power (W)	Typical Efficacy (lm/W)
BXRC-57C2001-B-7x	5700	70	450	2803	2523	34.8	15.7	179
BXRC-57C2001-C-7x	5700	70	630	3924	3532	34.8	21.9	179
BXRC-57C2001-D-7x	5700	70	500	2846	2561	31.8	15.9	179
BXRC-57E2001-B-7x	5700	80	450	2662	2396	34.8	15.7	170
BXRC-57E2001-C-7x	5700	80	630	3727	3354	34.8	21.9	170
BXRC-57E2001-D-7x	5700	80	500	2703	2433	31.8	15.9	170
BXRC-65C2001-B-7x	6500	70	450	2803	2523	34.8	15.7	179
BXRC-65C2001-C-7x	6500	70	630	3924	3532	34.8	21.9	179
BXRC-65C2001-D-7x	6500	70	500	2846	2561	31.8	15.9	179
BXRC-65E2001-B-7x	6500	80	450	2694	2424	34.8	15.7	172
BXRC-65E2001-C-7x	6500	80	630	3771	3394	34.8	21.9	172
BXRC-65E2001-D-7x	6500	80	500	2735	2461	31.8	15.9	172

Notes for Table 1:

- Nominal CCT as defined by ANSI C78.377-2011. Products with a CCT of 5000K-6500K are hot targeted to $T_c = 85^\circ\text{C}$.
- CRI values are typical for Decor Series Ultra, Decor Series Street and Landmark and Decor Series Class A products. CRI values are minimums for all other products. Minimum Rg value for 80 CRI products is 0, the minimum Rg value for 90 CRI products is 50, the minimum Rg value for 97 CRI products is 93. Bridgelux maintains a ± 3 tolerance on CRI and Rg values.
- Drive current is referred to as nominal drive current.
- Products tested under pulsed condition (10ms pulse width) at nominal test current where T_j (junction temperature) - T_c (case temperature) = 25°C .
- Typical performance values are provided as a reference only and are not a guarantee of performance.
- Bridgelux maintains a $\pm 7\%$ tolerance on flux measurements.
- Minimum flux values at the nominal test current are guaranteed by 100% test.
- Nominal CCT is defined by the Lighting Research Center's Class A definition. The center of the Class A color bin is on the corresponding isothermal line.
- GAI value is 80. To help ensure optimal fixture level performance, GAI is measured at the fixture level, on axis, at a case temperature of 70°C . GAI may vary depending on fixture design and performance.

Product Selection Guide

Table 2: Selection Guide, Stabilized DC Performance ($T_c = 70^\circ\text{C}$) ^{7,8}

Part Number	Nominal CCT ¹ (K)	GAI ²	CRI ³	Nominal Drive Current ⁴ (mA)	Typical DC Flux ^{5,6} $T_c = 70^\circ\text{C}$ (lm)	Minimum DC Flux ^{6,9} $T_c = 70^\circ\text{C}$ (lm)	Typical V_f (V)	Typical Power (W)	Typical Efficacy (lm/W)
BXRC-30A2001-B-7x	3000	80	93	450	1806	1625	34.4	15.5	117
BXRC-30A2001-C-7x	3000	80	93	630	2528	2275	34.4	21.6	117
BXRC-30A2001-D-7x	3000	80	93	500	1834	1650	31.2	15.6	118
BXRC-35A2001-B-7x	3500	80	93	450	1922	1730	34.4	15.5	124
BXRC-35A2001-C-7x	3500	80	93	630	2691	2422	34.4	21.6	124
BXRC-35A2001-D-7x	3500	80	93	500	1952	1757	31.2	15.6	125
BXRC-40A2001-B-7x	4000	80	93	450	2083	1874	34.4	15.5	135
BXRC-40A2001-C-7x	4000	80	93	630	2916	2624	34.4	21.6	135
BXRC-40A2001-D-7x	4000	80	93	500	2115	1903	31.2	15.6	136

Notes for Table 2:

- Nominal CCT is defined by the Lighting Research Center's Class A definition. The center of the Class A color bin is on the corresponding isothermal line.
- To help ensure optimal fixture level performance, GAI is measured at the fixture level, on axis, at a case temperature of 70°C . GAI may vary depending on fixture design and performance.
- CRI Values are specified as typical.
- Drive current is referred to as nominal drive current.
- Typical performance values are provided as a reference only and are not a guarantee of performance.
- Bridgelux maintains a $\pm 7\%$ tolerance on flux measurements.
- Typical stabilized DC performance values are provided as reference only and are not a guarantee of performance.
- Typical performance is estimated based on operation under DC (direct current) with LED array mounted onto a heat sink with thermal interface material and the case temperature maintained at specified temperature. Based on Bridgelux test setup, values may vary depending on the thermal design of the luminaire and/or the exposed environment to which the product is subjected.
- Minimum flux values at elevated temperatures are provided for reference only and are not guaranteed by 100% production testing. Based on Bridgelux test setup, values may vary depending on the thermal design of the luminaire and/or the exposed environment to which the product is subjected.

Product Selection Guide

Table 3: Selection Guide, Stabilized DC Performance ($T_c = 85^\circ\text{C}$)^{4,5}

Part Number	Nominal CCT ¹ (K)	CRI ²	Nominal Drive Current ³ (mA)	Typical DC Flux ^{4,5} $T_c = 85^\circ\text{C}$ (lm)	Minimum DC Flux ⁶ $T_c = 85^\circ\text{C}$ (lm)	Typical V_f (V)	Typical Power (W)	Typical Efficacy (lm/W)
BXRC-27E2000-B-7x	2700	80	450	2255	2030	33.9	15.3	148
BXRC-27E2000-C-7x	2700	80	630	3157	2841	33.9	21.4	148
BXRC-27E2000-D-7x	2700	80	500	2290	2061	30.9	15.5	148
BXRC-27G20H0-B-7x	2700	90	450	1931	1738	33.9	15.3	127
BXRC-27G20H0-C-7x	2700	90	630	2703	2433	33.9	21.4	127
BXRC-27G20H0-D-7x	2700	90	500	1960	1764	30.9	15.5	127
BXRC-27G2000-B-7x	2700	90	450	1860	1674	33.9	15.3	122
BXRC-27G2000-C-7x	2700	90	630	2605	2344	33.9	21.4	122
BXRC-27G2000-D-7x	2700	90	500	1889	1700	30.9	15.5	122
BXRC-27H2000-B-7x	2700	97	450	1649	1484	33.9	15.3	108
BXRC-27H2000-C-7x	2700	97	630	2309	2078	33.9	21.4	108
BXRC-27H2000-D-7x	2700	97	500	1674	1507	30.9	15.5	108
BXRC-30C2001-B-7x	3000	70	450	2509	2258	33.9	15.3	164
BXRC-30C2001-C-7x	3000	70	630	3512	3161	33.9	21.4	164
BXRC-30C2001-D-7x	3000	70	500	2547	2292	30.9	15.5	165
BXRC-30E2000-B-7x	3000	80	450	2396	2156	33.9	15.3	157
BXRC-30E2000-C-7x	3000	80	630	3354	3019	33.9	21.4	157
BXRC-30E2000-D-7x	3000	80	500	2433	2189	30.9	15.5	157
BXRC-30G20H0-B-7x	3000	90	450	2030	1827	33.9	15.3	133
BXRC-30G20H0-C-7x	3000	90	630	2841	2557	33.9	21.4	133
BXRC-30G20H0-D-7x	3000	90	500	2061	1855	30.9	15.5	133
BXRC-30G2000-B-7x	3000	90	450	1945	1750	33.9	15.3	127
BXRC-30G2000-C-7x	3000	90	630	2723	2451	33.9	21.4	127
BXRC-30G2000-D-7x	3000	90	500	1975	1777	30.9	15.5	128
BXRC-30G200C-B-7x	3000	90	450	1885	1697	34.1	15.3	123
BXRC-30G200C-D-7x	3000	90	500	1903	1713	30.9	15.5	123
BXRC-30H2000-B-7x	3000	97	450	1762	1586	33.9	15.3	115
BXRC-30H2000-C-7x	3000	97	630	2466	2220	33.9	21.4	115
BXRC-30H2000-D-7x	3000	97	500	1789	1610	30.9	15.5	116
BXRC-30A2001-B-7x ^{7,8}	3000	93	450	1748	1573	33.9	15.3	115
BXRC-30A2001-C-7x ^{7,8}	3000	93	630	2447	2202	33.9	21.4	115
BXRC-30A2001-D-7x ^{7,8}	3000	93	500	1774	1597	30.9	15.5	115

Notes for Table 3:

- Nominal CCT as defined by ANSI C78.377-2011. Products with a CCT of 5000K-6500K are hot targeted to $T_c = 85^\circ\text{C}$.
- All CRI values are measured at $T_c = T_a = 25^\circ\text{C}$. CRI values are typical for Decor Series Ultra, Decor Series Street and Landmark and Decor Series Class A products. CRI values are minimums for all other products. Minimum R9 value for 80 CRI products is 0, the minimum R9 value for 90 CRI products is 50, the minimum R9 value for 97 CRI products is 93. Bridgelux maintains a ± 3 tolerance on CRI and R9 values.
- Drive current is referred to as nominal drive current.
- Typical stabilized DC performance values are provided as reference only and are not a guarantee of performance.
- Typical performance is estimated based on operation under DC (direct current) with LED array mounted onto a heat sink with thermal interface material and the case temperature maintained at 85°C . Based on Bridgelux test setup, values may vary depending on the thermal design of the luminaire and/or the exposed environment to which the product is subjected.
- Minimum flux values at elevated temperatures are provided for reference only and are not guaranteed by 100% production testing. Based on Bridgelux test setup, values may vary depending on the thermal design of the luminaire and/or the exposed environment to which the product is subjected.
- Nominal CCT is defined by the Lighting Research Center's Class A definition. The center of the Class A color bin is on the corresponding isothermal line.
- GAI value is 80. To help ensure optimal fixture level performance, GAI is measured at the fixture level, on axis, at a case temperature of 70°C . GAI may vary depending on fixture design and performance.

Product Selection Guide

Table 3: Selection Guide, Stabilized DC Performance ($T_c = 85^\circ\text{C}$)^{4,5} (continued)

Part Number	Nominal CCT ¹ (K)	CRI ²	Nominal Drive Current ³ (mA)	Typical DC Flux ^{4,5} $T_c = 85^\circ\text{C}$ (lm)	Minimum DC Flux ⁶ $T_c = 85^\circ\text{C}$ (lm)	Typical V_f (V)	Typical Power (W)	Typical Efficacy (lm/W)
BXRC-35E2000-B-7x	3500	80	450	2452	2207	33.9	15.3	161
BXRC-35E2000-C-7x	3500	80	630	3433	3090	33.9	21.4	161
BXRC-35E2000-D-7x	3500	80	500	2490	2241	30.9	15.5	161
BXRC-35G2000-B-7x	3500	90	450	2015	1814	33.9	15.3	132
BXRC-35G2000-C-7x	3500	90	630	2822	2539	33.9	21.4	132
BXRC-35G2000-D-7x	3500	90	500	2046	1842	30.9	15.5	132
BXRC-35A2001-B-7x ^{7,8}	3500	93	450	1860	1674	33.9	15.3	122
BXRC-35A2001-C-7x ^{7,8}	3500	93	630	2605	2344	33.9	21.4	122
BXRC-35A2001-D-7x ^{7,8}	3500	93	500	1889	1700	30.9	15.5	122
BXRC-40C2001-B-7x	4000	70	450	2579	2321	33.9	15.3	169
BXRC-40C2001-C-7x	4000	70	630	3611	3250	33.9	21.4	169
BXRC-40C2001-D-7x	4000	70	500	2619	2357	30.9	15.5	169
BXRC-40E2000-B-7x	4000	80	450	2466	2220	33.9	15.3	162
BXRC-40E2000-C-7x	4000	80	630	3453	3108	33.9	21.4	162
BXRC-40E2000-D-7x	4000	80	500	2504	2254	30.9	15.5	162
BXRC-40G2000-B-7x	4000	90	450	2058	1852	33.9	15.3	135
BXRC-40G2000-C-7x	4000	90	630	2881	2593	33.9	21.4	135
BXRC-40G2000-D-7x	4000	90	500	2089	1880	30.9	15.5	135
BXRC-40H2000-B-7x	4000	97	450	1860	1674	33.9	15.3	122
BXRC-40H2000-C-7x	4000	97	630	2605	2344	33.9	21.4	122
BXRC-40H2000-D-7x	4000	97	500	1889	1700	30.9	15.5	122
BXRC-40A2001-B-7x ^{7,8}	4000	93	450	2015	1814	33.9	15.3	132
BXRC-40A2001-C-7x ^{7,8}	4000	93	630	2822	2539	33.9	21.4	132
BXRC-40A2001-D-7x ^{7,8}	4000	93	500	2046	1842	30.9	15.5	132
BXRC-50C2001-B-7x	5000	70	450	2593	2334	33.9	15.3	170
BXRC-50C2001-C-7x	5000	70	630	3631	3268	33.9	21.4	170
BXRC-50C2001-D-7x	5000	70	500	2633	2370	30.9	15.5	170
BXRC-50E2001-B-7x	5000	80	450	2495	2245	33.9	15.3	164
BXRC-50E2001-C-7x	5000	80	630	3492	3143	33.9	21.4	164
BXRC-50E2001-D-7x	5000	80	500	2533	2280	30.9	15.5	164
BXRC-50G2001-B-7x	5000	90	450	2156	1941	33.9	15.3	141
BXRC-50G2001-C-7x	5000	90	630	3019	2717	33.9	21.4	141
BXRC-50G2001-D-7x	5000	90	500	2189	1970	30.9	15.5	142

Notes for Table 3:

- Nominal CCT as defined by ANSI C78.377-2011. Products with a CCT of 5000K-6500K are hot targeted to $T_c = 85^\circ\text{C}$.
- All CRI values are measured at $T_c = 25^\circ\text{C}$. CRI values are typical for Decor Series Ultra, Decor Series Street and Landmark and Decor Series Class A products. CRI values are minimums for all other products. Minimum R_g value for 80 CRI products is 0, the minimum R_g value for 90 CRI products is 50, the minimum R_g value for 97 CRI products is 93. Bridgelux maintains a ± 3 tolerance on CRI and R_g values.
- Drive current is referred to as nominal drive current.
- Typical stabilized DC performance values are provided as reference only and are not a guarantee of performance.
- Typical performance is estimated based on operation under DC (direct current) with LED array mounted onto a heat sink with thermal interface material and the case temperature maintained at 85°C . Based on Bridgelux test setup, values may vary depending on the thermal design of the luminaire and/or the exposed environment to which the product is subjected.
- Minimum flux values at elevated temperatures are provided for reference only and are not guaranteed by 100% production testing. Based on Bridgelux test setup, values may vary depending on the thermal design of the luminaire and/or the exposed environment to which the product is subjected.
- Nominal CCT is defined by the Lighting Research Center's Class A definition. The center of the Class A color bin is on the corresponding isothermal line.
- GAI value is 80. To help ensure optimal fixture level performance, GAI is measured at the fixture level, on axis, at a case temperature of 70°C . GAI may vary depending on fixture design and performance.

Product Selection Guide

Table 3: Selection Guide, Stabilized DC Performance ($T_c = 85^\circ\text{C}$)^{4,5}

Part Number	Nominal CCT ¹ (K)	CRI ²	Nominal Drive Current ³ (mA)	Typical DC Flux ^{4,5} $T_c = 85^\circ\text{C}$ (lm)	Minimum DC Flux ⁶ $T_c = 85^\circ\text{C}$ (lm)	Typical V_f (V)	Typical Power (W)	Typical Efficacy (lm/W)
BXRC-57C2001-B-7x	5700	70	450	2523	2271	33.9	15.3	165
BXRC-57C2001-C-7x	5700	70	630	3532	3179	33.9	21.4	165
BXRC-57C2001-D-7x	5700	70	500	2561	2305	30.9	15.5	166
BXRC-57E2001-B-7x	5700	80	450	2396	2156	33.9	15.3	157
BXRC-57E2001-C-7x	5700	80	630	3354	3019	33.9	21.4	157
BXRC-57E2001-D-7x	5700	80	500	2433	2189	30.9	15.5	157
BXRC-65C2001-B-7x	6500	70	450	2523	2271	33.9	15.3	165
BXRC-65C2001-C-7x	6500	70	630	3532	3179	33.9	21.4	165
BXRC-65C2001-D-7x	6500	70	500	2561	2305	30.9	15.5	166
BXRC-65E2001-B-7x	6500	80	450	2424	2182	33.9	15.3	159
BXRC-65E2001-C-7x	6500	80	630	3394	3054	33.9	21.4	159
BXRC-65E2001-D-7x	6500	80	500	2461	2215	30.9	15.5	159

Notes for Table 3:

- Nominal CCT as defined by ANSI C78.377-2011. Products with a CCT of 5000K-6500K are hot targeted to $T_c = 85^\circ\text{C}$.
- All CRI values are measured at $T_s = T_c = 25^\circ\text{C}$. CRI values are typical for Decor Series Ultra, Decor Series Street and Landmark and Decor Series Class A products. CRI values are minimums for all other products. Minimum R_g value for 80 CRI products is 0, the minimum R_g value for 90 CRI products is 50, the minimum R_g value for 97 CRI products is 93. Bridgelux maintains a ± 3 tolerance on CRI and R_g values.
- Drive current is referred to as nominal drive current.
- Typical stabilized DC performance values are provided as reference only and are not a guarantee of performance.
- Typical performance is estimated based on operation under DC (direct current) with LED array mounted onto a heat sink with thermal interface material and the case temperature maintained at 85°C . Based on Bridgelux test setup, values may vary depending on the thermal design of the luminaire and/or the exposed environment to which the product is subjected.
- Minimum flux values at elevated temperatures are provided for reference only and are not guaranteed by 100% production testing. Based on Bridgelux test setup, values may vary depending on the thermal design of the luminaire and/or the exposed environment to which the product is subjected.
- Nominal CCT is defined by the Lighting Research Center's Class A definition. The center of the Class A color bin is on the corresponding isothermal line.
- GAI value is 80. To help ensure optimal fixture level performance, GAI is measured at the fixture level, on axis, at a case temperature of 70°C . GAI may vary depending on fixture design and performance.

European Product Registry for Energy Labeling

The European Product Registry for Energy Labeling (EPREL) is defined in the EU Regulation 2017/1369 to provide important energy efficiency information to consumers. Together with Energy Labeling Regulation ELR (EU) 2019/2015 which was amended by regulation (EU) 2021/340 for energy labelling of light sources, manufacturers are required to declare an energy class based on key technical specifications from each of their product and register it in an open data base managed by EPREL. It is now a legal requirement for a vendor of light sources to upload information about their products into the EPREL database before placing these products on the market in the EU.

Table 4 below provides a list of part numbers that are in compliance with ELR and are currently listed in the EPREL database.

At Bridgelux, we are fully committed to supplying products that are compliant with pertinent laws, rules, and obligation imposed by relevant government bodies including the European Energy Labeling regulation. Customers can use these products with full confidence for any projects that fall under the ELR.

Table 4: Part numbers registered in European Product Registry for Energy Labeling

PART NUMBER ¹	CCT (K)	CRI	Current ² (mA)	Vf (V)	Useful flux ³ (Φ_{use}) at 85C (lm)	Power (W)	Efficacy (lm/W)	Energy efficiency class ⁴	Registration No	URL to Product Information Sheet in EPREL Database
BXRC-27E2000-B-7x	2700	80	900	35.2	4091	31.7	129	E	871032	https://eprelec.europa.eu/qr/871032
BXRC-27E2000-C-7x	2700	80	1260	35.2	5727	44.4	129	E	871039	https://eprelec.europa.eu/qr/871039
BXRC-27E2000-D-7x	2700	80	1000	33.6	4198	33.6	125	E	871044	https://eprelec.europa.eu/qr/871044
BXRC-27G20H0-B-7x	2700	90	900	35.2	3503	31.7	110	F	871141	https://eprelec.europa.eu/qr/871141
BXRC-27G20H0-C-7x	2700	90	1260	35.2	4904	44.4	110	F	871145	https://eprelec.europa.eu/qr/871145
BXRC-27G20H0-D-7x	2700	90	960	33.4	3474	32.1	108	F	871149	https://eprelec.europa.eu/qr/871149
BXRC-27G2000-B-7x	2700	90	860	35.0	3249	30.1	108	F	871125	https://eprelec.europa.eu/qr/871125
BXRC-27G2000-C-7x	2700	90	1160	34.8	4414	40.4	109	F	871132	https://eprelec.europa.eu/qr/871132
BXRC-27G2000-D-7x	2700	90	870	33.0	3087	28.7	108	F	871137	https://eprelec.europa.eu/qr/871137
BXRC-27H2000-B-7x	2700	95	670	33.9	2333	22.7	103	F	871207	https://eprelec.europa.eu/qr/871207
BXRC-27H2000-C-7x	2700	95	870	33.6	3056	29.2	105	F	871213	https://eprelec.europa.eu/qr/871213
BXRC-27H2000-D-7x	2700	95	660	31.9	2151	21.0	102	F	871217	https://eprelec.europa.eu/qr/871217
BXRC-30C2001-B-7x	3000	70	900	35.2	4551	31.7	143	E	871292	https://eprelec.europa.eu/qr/871292
BXRC-30C2001-C-7x	3000	70	1260	35.2	6371	44.4	143	E	871298	https://eprelec.europa.eu/qr/871298
BXRC-30C2001-D-7x	3000	70	1000	33.6	4670	33.6	139	E	871304	https://eprelec.europa.eu/qr/871304
BXRC-30E2000-B-7x	3000	80	900	35.2	4346	31.7	137	E	871362	https://eprelec.europa.eu/qr/871362
BXRC-30E2000-C-7x	3000	80	1260	35.2	6085	44.4	137	E	871369	https://eprelec.europa.eu/qr/871369
BXRC-30E2000-D-7x	3000	80	1000	33.6	4460	33.6	133	E	871374	https://eprelec.europa.eu/qr/871374

Notes for Table 4:

- All device listed here must be disposed as e-waste upon its end of life according to local country guideline in each country.
- For information on performance values at alternative drive conditions, please refer to the Product Selection Guide, Absolute Maximum Rating Table and Performance Curves in this data sheet.
- For a definition of useful luminous flux (Φ_{use}), please see the ELR regulations at <https://tinyurl.com/4b6zvt4m>.
- EPREL requires an arrow symbol containing the letter of the energy efficiency class to be displayed, on technical promotional material. Refer to this energy efficiency class column for specific energy efficiency class on each part number.

European Product Registry for Energy Labeling

Table 4: Part numbers registered in European Product Registry for Energy Labeling (Continued)

PART NUMBER ¹	CCT (K)	CRI	Current ² (mA)	Vf (V)	Useful flux ³ (Φ_{use}) at 85C (lm)	Power (W)	Efficacy (lm/W)	Energy efficiency class ⁴	Registration No	URL to Product Information Sheet in EPREL Database
BXRC-30G20H0-B-7x	3000	90	900	35.2	3682	31.7	116	F	871483	https://eprel.ec.europa.eu/qr/871483
BXRC-30G20H0-C-7x	3000	90	1260	35.2	5154	44.4	116	F	871487	https://eprel.ec.europa.eu/qr/871487
BXRC-30G20H0-D-7x	3000	90	1000	33.6	3778	33.6	112	F	871491	https://eprel.ec.europa.eu/qr/871491
BXRC-30G2000-B-7x	3000	90	900	35.2	3528	31.7	111	F	871463	https://eprel.ec.europa.eu/qr/871463
BXRC-30G2000-C-7x	3000	90	1260	35.2	4940	44.4	111	F	871470	https://eprel.ec.europa.eu/qr/871470
BXRC-30G2000-D-7x	3000	90	980	33.5	3557	32.8	108	F	871475	https://eprel.ec.europa.eu/qr/871475
BXRC-30G200C-B-7x	3000	90	900	35.2	3528	31.7	111	F	871479	https://eprel.ec.europa.eu/qr/871479
BXRC-30G200C-D-7x	3000	90	980	33.5	3557	32.8	108	F	871481	https://eprel.ec.europa.eu/qr/871481
BXRC-30H2000-B-7x	3000	95	810	34.7	2930	28.1	104	F	871553	https://eprel.ec.europa.eu/qr/871553
BXRC-30H2000-C-7x	3000	95	1080	34.5	3939	37.3	106	F	871559	https://eprel.ec.europa.eu/qr/871559
BXRC-30H2000-D-7x	3000	95	810	32.6	2752	26.4	104	F	871563	https://eprel.ec.europa.eu/qr/871563
BXRC-30A2001-B-7x	3000	90	730	34.2	2663	25.0	107	F	871246	https://eprel.ec.europa.eu/qr/871246
BXRC-30A2001-C-7x	3000	90	960	34.0	3532	32.6	108	F	871248	https://eprel.ec.europa.eu/qr/871248
BXRC-30A2001-D-7x	3000	90	730	32.2	2494	23.5	106	F	871249	https://eprel.ec.europa.eu/qr/871249
BXRC-35E2000-B-7x	3500	80	900	35.2	4449	31.7	140	E	871636	https://eprel.ec.europa.eu/qr/871636
BXRC-35E2000-C-7x	3500	80	1260	35.2	6228	44.4	140	E	871643	https://eprel.ec.europa.eu/qr/871643
BXRC-35E2000-D-7x	3500	80	1000	33.6	4565	33.6	136	E	871648	https://eprel.ec.europa.eu/qr/871648
BXRC-35G2000-B-7x	3500	90	900	35.2	3656	31.7	115	F	871703	https://eprel.ec.europa.eu/qr/871703
BXRC-35G2000-C-7x	3500	90	1260	35.2	5119	44.4	115	F	871710	https://eprel.ec.europa.eu/qr/871710
BXRC-35G2000-D-7x	3500	90	1000	33.6	3752	33.6	112	F	871715	https://eprel.ec.europa.eu/qr/871715
BXRC-35A2001-B-7x	3500	90	860	35.0	3249	30.1	108	F	871592	https://eprel.ec.europa.eu/qr/871592
BXRC-35A2001-C-7x	3500	90	1160	34.8	4414	40.4	109	F	871594	https://eprel.ec.europa.eu/qr/871594
BXRC-35A2001-D-7x	3500	90	870	33.0	3087	28.7	108	F	871595	https://eprel.ec.europa.eu/qr/871595
BXRC-40C2001-B-7x	4000	70	900	35.2	4679	31.7	148	D	871795	https://eprel.ec.europa.eu/qr/871795
BXRC-40C2001-C-7x	4000	70	1260	35.2	6550	44.4	148	D	871801	https://eprel.ec.europa.eu/qr/871801
BXRC-40C2001-D-7x	4000	70	1000	33.6	4801	33.6	143	E	871807	https://eprel.ec.europa.eu/qr/871807
BXRC-40E2000-B-7x	4000	80	900	35.2	4474	31.7	141	E	871868	https://eprel.ec.europa.eu/qr/871868
BXRC-40E2000-C-7x	4000	80	1260	35.2	6264	44.4	141	E	871875	https://eprel.ec.europa.eu/qr/871875
BXRC-40E2000-D-7x	4000	80	1000	33.6	4591	33.6	137	E	871880	https://eprel.ec.europa.eu/qr/871880
BXRC-40G2000-B-7x	4000	90	900	35.2	3733	31.7	118	F	871937	https://eprel.ec.europa.eu/qr/871937
BXRC-40G2000-C-7x	4000	90	1260	35.2	5226	44.4	118	F	871944	https://eprel.ec.europa.eu/qr/871944
BXRC-40G2000-D-7x	4000	90	1000	33.6	3830	33.6	114	F	871949	https://eprel.ec.europa.eu/qr/871949
BXRC-40H2000-B-7x	4000	95	900	35.2	3375	31.7	106	F	871978	https://eprel.ec.europa.eu/qr/871978
BXRC-40H2000-C-7x	4000	95	1260	35.2	4725	44.4	106	F	871980	https://eprel.ec.europa.eu/qr/871980
BXRC-40H2000-D-7x	4000	95	940	33.3	3290	31.3	105	F	871982	https://eprel.ec.europa.eu/qr/871982

Notes for Table 4:

- All device listed here must be disposed as e-waste upon its end of life according to local country guideline in each country.
- For information on performance values at alternative drive conditions, please refer to the Product Selection Guide, Absolute Maximum Rating Table and Performance Curves in this data sheet.
- For a definition of useful luminous flux (Φ_{use}), please see the ELR regulations at <https://tinyurl.com/4b6zvt4m>.
- EPREL requires an arrow symbol containing the letter of the energy efficiency class to be displayed, on technical promotional material. Refer to this energy efficiency class column for specific energy efficiency class on each part number.

European Product Registry for Energy Labeling

Table 4: Part numbers registered in European Product Registry for Energy Labeling (Continued)

PART NUMBER ¹	CCT (K)	CRI	Current ² (mA)	Vf (V)	Useful flux ³ (Φ_{use}) at 85C (lm)	Power (W)	Efficacy (lm/W)	Energy efficiency class ⁴ 	Registration No	URL to Product Information Sheet in EPREL Database
BXRC-40A2001-B-7x	4000	90	900	35.2	3656	31.7	115	F	871747	https://eprelec.europa.eu/qr/871747
BXRC-40A2001-C-7x	4000	90	1260	35.2	5119	44.4	115	F	871749	https://eprelec.europa.eu/qr/871749
BXRC-40A2001-D-7x	4000	90	1000	33.6	3752	33.6	112	F	871750	https://eprelec.europa.eu/qr/871750
BXRC-50C2001-B-7x	5000	70	900	35.2	4704	31.7	148	D	872020	https://eprelec.europa.eu/qr/872020
BXRC-50C2001-C-7x	5000	70	1260	35.2	6586	44.4	148	D	872024	https://eprelec.europa.eu/qr/872024
BXRC-50C2001-D-7x	5000	70	1000	33.6	4827	33.6	144	E	872028	https://eprelec.europa.eu/qr/872028
BXRC-50E2001-B-7x	5000	80	900	35.2	4525	31.7	143	E	872072	https://eprelec.europa.eu/qr/872072
BXRC-50E2001-C-7x	5000	80	1260	35.2	6336	44.4	143	E	872076	https://eprelec.europa.eu/qr/872076
BXRC-50E2001-D-7x	5000	80	1000	33.6	4644	33.6	138	E	872080	https://eprelec.europa.eu/qr/872080
BXRC-50G2001-B-7x	5000	90	900	35.2	3912	31.7	123	E	872125	https://eprelec.europa.eu/qr/872125
BXRC-50G2001-C-7x	5000	90	1260	35.2	5476	44.4	123	E	872129	https://eprelec.europa.eu/qr/872129
BXRC-50G2001-D-7x	5000	90	1000	33.6	4014	33.6	119	E	872133	https://eprelec.europa.eu/qr/872133
BXRC-57C2001-B-7x	5700	70	900	35.2	4577	31.7	144	E	872228	https://eprelec.europa.eu/qr/872228
BXRC-57C2001-C-7x	5700	70	1260	35.2	6407	44.4	144	E	872233	https://eprelec.europa.eu/qr/872233
BXRC-57C2001-D-7x	5700	70	1000	33.6	4696	33.6	140	E	872237	https://eprelec.europa.eu/qr/872237
BXRC-57E2001-B-7x	5700	80	900	35.2	4346	31.7	137	E	872277	https://eprelec.europa.eu/qr/872277
BXRC-57E2001-C-7x	5700	80	1260	35.2	6085	44.4	137	E	872281	https://eprelec.europa.eu/qr/872281
BXRC-57E2001-D-7x	5700	80	1000	33.6	4460	33.6	133	E	872285	https://eprelec.europa.eu/qr/872285
BXRC-65C2001-B-7x	6500	70	900	35.2	4577	31.7	144	E	872326	https://eprelec.europa.eu/qr/872326
BXRC-65C2001-C-7x	6500	70	1260	35.2	6407	44.4	144	E	872330	https://eprelec.europa.eu/qr/872330
BXRC-65C2001-D-7x	6500	70	1000	33.6	4696	33.6	140	E	872334	https://eprelec.europa.eu/qr/872334
BXRC-65E2001-B-7x	6500	80	900	35.2	4398	31.7	139	E	872375	https://eprelec.europa.eu/qr/872375
BXRC-65E2001-C-7x	6500	80	1260	35.2	6157	44.4	139	E	872379	https://eprelec.europa.eu/qr/872379
BXRC-65E2001-D-7x	6500	80	1000	33.6	4512	33.6	134	E	872383	https://eprelec.europa.eu/qr/872383

Notes for Table 4:

1. All device listed here must be disposed as e-waste upon its end of life according to local country guideline in each country.
2. For information on performance values at alternative drive conditions, please refer to the Product Selection Guide, Absolute Maximum Rating Table and Performance Curves in this data sheet.
3. For a definition of useful luminous flux (Φ_{use}), please see the ELR regulations at <https://tinyurl.com/4b6zv4m>.
4. EPREL requires an arrow symbol containing the letter of the energy efficiency class to be displayed, on technical promotional material. Refer to this energy efficiency class column for specific energy efficiency class on each part number.

Performance at Commonly Used Drive Currents

Vero LED arrays are tested to the specifications shown using the nominal drive currents in Table 1. Vero may also be driven at other drive currents dependent on specific application design requirements. The performance at any drive current can be derived from the current vs. voltage characteristics shown in Figures 1, 2 & 3 and the flux vs. current characteristics shown in Figures 4, 5 & 6. The performance at commonly used drive currents is summarized in Table 5.

Table 5: Product Performance at Commonly Used Drive Currents

Part Number	CRI	Drive Current ¹ (mA)	Typical V _f T _c = 25°C (V)	Typical Power T _c = 25°C (W)	Typical Flux ² T _c = 25°C (lm)	Typical DC Flux ³ T _c = 85°C (lm)	Typical Efficacy T _c = 25°C (lm/W)
BXRC-27E2000-B-7x	80	113	33.2	3.7	682	625	183
		225	34.0	7.7	1321	1198	173
		450	34.8	15.7	2506	2255	160
		675	35.6	24.1	3621	3171	151
		900	36.1	32.5	4619	3967	142
BXRC-27E2000-C-7x	80	158	33.2	5.2	948	896	181
		315	34.0	10.7	1835	1728	171
		630	34.8	21.9	3508	3157	160
		945	35.6	33.7	5035	4707	150
		1260	36.1	45.5	6426	5987	141
BXRC-27E2000-D-7x	80	125	29.6	3.7	673	643	182
		250	30.3	7.6	1305	1243	172
		500	31.8	15.9	2544	2290	160
		750	33.2	24.9	3595	3406	144
		1000	34.4	34.4	4597	4344	134
BXRC-27G20H0-B-7x	90	113	33.2	3.7	584	535	156
		225	34.0	7.7	1131	1026	148
		450	34.8	15.7	2145	1931	137
		675	35.6	24.1	3100	2715	129
		900	36.1	32.5	3955	3397	122
BXRC-27G20H0-C-7x	90	158	33.2	5.2	812	767	155
		315	34.0	10.7	1571	1479	147
		630	34.8	21.9	3004	2703	137
		945	35.6	33.7	4311	4030	128
		1260	36.1	45.5	5502	5127	121
BXRC-27G20H0-D-7x	90	125	29.6	3.7	577	551	156
		250	30.3	7.6	1118	1065	147
		500	31.8	15.9	2178	1960	137
		750	33.2	24.9	3078	2916	124
		1000	34.4	34.4	3936	3719	114
BXRC-27G2000-B-7x	90	113	33.2	3.7	563	516	151
		225	34.0	7.7	1090	988	142
		450	34.8	15.7	2067	1860	132
		675	35.6	24.1	2987	2616	124
		900	36.1	32.5	3811	3273	117
BXRC-27G2000-C-7x	90	158	33.2	5.2	782	739	149
		315	34.0	10.7	1514	1425	141
		630	34.8	21.9	2894	2605	132
		945	35.6	33.7	4154	3883	123
		1260	36.1	45.5	5301	4940	116

Notes for Table 5:

1. Alternate drive currents are provided for reference only and are not a guarantee of performance.
2. Bridgelux maintains a ± 7% tolerance on flux measurements.
3. Typical stabilized DC performance values are provided as reference only and are not a guarantee of performance.

Performance at Commonly Used Drive Currents

Table 5: Product Performance at Commonly Used Drive Currents (Continued)

Part Number	CRI	Drive Current ¹ (mA)	Typical V _f T _c = 25°C (V)	Typical Power T _c = 25°C (W)	Typical Flux ² T _c = 25°C (lm)	Typical DC Flux ³ T _c = 85°C (lm)	Typical Efficacy T _c = 25°C (lm/W)
BXRC-27G2000-D-7x	90	125	29.6	3.7	556	531	150
		250	30.3	7.6	1077	1026	142
		500	31.8	15.9	2099	1889	132
		750	33.2	24.9	2966	2810	119
		1000	34.4	34.4	3792	3584	110
BXRC-27H2000-B-7x	97	113	33.2	3.7	499	457	134
		225	34.0	7.7	966	876	126
		450	34.8	15.7	1832	1649	117
		675	35.6	24.1	2648	2319	110
		900	36.1	32.5	3378	2901	104
BXRC-27H2000-C-7x	97	158	33.2	5.2	693	655	132
		315	34.0	10.7	1342	1263	125
		630	34.8	21.9	2565	2309	117
		945	35.6	33.7	3682	3442	109
		1260	36.1	45.5	4699	4378	103
BXRC-27H2000-D-7x	97	125	29.6	3.7	492	470	133
		250	30.3	7.6	955	909	126
		500	31.8	15.9	1860	1674	117
		750	33.2	24.9	2629	2490	106
		1000	34.4	34.4	3361	3176	98
BXRC-30C2001-B-7x	70	113	33.2	3.7	759	696	203
		225	34.0	7.7	1469	1333	192
		450	34.8	15.7	2787	2509	178
		675	35.6	24.1	4028	3528	167
		900	36.1	32.5	5138	4414	158
BXRC-30C2001-C-7x	70	158	33.2	5.2	1054	997	202
		315	34.0	10.7	2041	1922	191
		630	34.8	21.9	3902	3512	178
		945	35.6	33.7	5601	5236	166
		1260	36.1	45.5	7149	6661	157
BXRC-30C2001-D-7x	70	125	29.6	3.7	749	716	203
		250	30.3	7.6	1452	1383	191
		500	31.8	15.9	2830	2547	178
		750	33.2	24.9	3999	3789	161
		1000	34.4	34.4	5114	4833	149
BXRC-30E2000-B-7x	80	113	33.2	3.7	725	664	194
		225	34.0	7.7	1403	1273	183
		450	34.8	15.7	2662	2396	170
		675	35.6	24.1	3847	3369	160
		900	36.1	32.5	4907	4215	151
BXRC-30E2000-C-7x	80	158	33.2	5.2	1007	952	193
		315	34.0	10.7	1949	1836	182
		630	34.8	21.9	3727	3354	170
		945	35.6	33.7	5349	5001	159
		1260	36.1	45.5	6828	6362	150

Notes for Table 5:

1. Alternate drive currents are provided for reference only and are not a guarantee of performance.
2. Bridgelux maintains a ± 7% tolerance on flux measurements.
3. Typical stabilized DC performance values are provided as reference only and are not a guarantee of performance.

Performance at Commonly Used Drive Currents

Table 5: Product Performance at Commonly Used Drive Currents (Continued)

Part Number	CRI	Drive Current ¹ (mA)	Typical V_f $T_c = 25^\circ\text{C}$ (V)	Typical Power $T_c = 25^\circ\text{C}$ (W)	Typical Flux ² $T_c = 25^\circ\text{C}$ (lm)	Typical DC Flux ³ $T_c = 85^\circ\text{C}$ (lm)	Typical Efficacy $T_c = 25^\circ\text{C}$ (lm/W)
BXRC-30E2000-D-7x	80	125	29.6	3.7	716	683	194
		250	30.3	7.6	1387	1321	183
		500	31.8	15.9	2703	2433	170
		750	33.2	24.9	3820	3619	153
		1000	34.4	34.4	4884	4615	142
BXRC-30G20H0-B-7x	90	113	33.2	3.7	614	563	164
		225	34.0	7.7	1189	1078	155
		450	34.8	15.7	2255	2030	144
		675	35.6	24.1	3259	2854	135
		900	36.1	32.5	4157	3571	128
BXRC-30G20H0-C-7x	90	158	33.2	5.2	853	806	163
		315	34.0	10.7	1651	1555	154
		630	34.8	21.9	3157	2841	144
		945	35.6	33.7	4531	4236	135
		1260	36.1	45.5	5783	5389	127
BXRC-30G20H0-D-7x	90	125	29.6	3.7	606	579	164
		250	30.3	7.6	1175	1119	155
		500	31.8	15.9	2290	2061	144
		750	33.2	24.9	3236	3065	130
		1000	34.4	34.4	4137	3909	120
BXRC-30G2000-B-7x	90	113	33.2	3.7	589	539	158
		225	34.0	7.7	1139	1033	149
		450	34.8	15.7	2161	1945	138
		675	35.6	24.1	3123	2735	130
		900	36.1	32.5	3984	3422	122
BXRC-30G2000-C-7x	90	158	33.2	5.2	817	773	156
		315	34.0	10.7	1583	1490	148
		630	34.8	21.9	3026	2723	138
		945	35.6	33.7	4343	4060	129
		1260	36.1	45.5	5542	5164	122
BXRC-30G2000-D-7x	90	125	29.6	3.7	581	555	157
		250	30.3	7.6	1126	1072	148
		500	31.8	15.9	2194	1975	138
		750	33.2	24.9	3101	2937	125
		1000	34.4	34.4	3965	3747	115
BXRC-30G200C-B-7x	90	113	33.2	3.7	570	523	153
		225	34.0	7.7	1104	1001	144
		450	34.8	15.7	2095	1885	134
		675	35.6	24.1	3027	2651	126
		900	36.1	32.5	3861	3317	119
BXRC-30G200C-D-7x	90	125	29.6	3.7	560	535	152
		250	30.3	7.6	1085	1034	143
		500	31.8	15.9	2115	1903	133
		750	33.2	24.9	2988	2831	120
		1000	34.4	34.4	3821	3611	111

Notes for Table 5:

1. Alternate drive currents are provided for reference only and are not a guarantee of performance.
2. Bridgelux maintains a $\pm 7\%$ tolerance on flux measurements.
3. Typical stabilized DC performance values are provided as reference only and are not a guarantee of performance.

Performance at Commonly Used Drive Currents

Table 5: Product Performance at Commonly Used Drive Currents (Continued)

Part Number	CRI	Drive Current ¹ (mA)	Typical V _f T _c = 25°C (V)	Typical Power T _c = 25°C (W)	Typical Flux ² T _c = 25°C (lm)	Typical DC Flux ³ T _c = 85°C (lm)	Typical Efficacy T _c = 25°C (lm/W)
BXRC-30H2000-B-7x	97	113	33.2	3.7	533	489	143
		225	34.0	7.7	1032	936	135
		450	34.8	15.7	1958	1762	125
		675	35.6	24.1	2829	2477	118
		900	36.1	32.5	3608	3100	111
BXRC-30H2000-C-7x	97	158	33.2	5.2	740	700	142
		315	34.0	10.7	1433	1350	134
		630	34.8	21.9	2741	2466	125
		945	35.6	33.7	3933	3677	117
		1260	36.1	45.5	5020	4678	110
BXRC-30H2000-D-7x	97	125	29.6	3.7	526	502	142
		250	30.3	7.6	1020	971	134
		500	31.8	15.9	1988	1789	125
		750	33.2	24.9	2809	2661	113
		1000	34.4	34.4	3591	3394	104
BXRC-30A2001-B-7x	93	113	33.2	3.7	529	485	142
		225	34.0	7.7	1024	928	134
		450	34.8	15.7	1942	1748	124
		675	35.6	24.1	2806	2458	117
		900	36.1	32.5	3580	3075	110
BXRC-30A2001-C-7x	93	158	33.2	5.2	735	694	140
		315	34.0	10.7	1422	1339	133
		630	34.8	21.9	2719	2447	124
		945	35.6	33.7	3902	3648	116
		1260	36.1	45.5	4980	4640	109
BXRC-30A2001-D-7x	93	125	29.6	3.7	522	498	141
		250	30.3	7.6	1012	964	133
		500	31.8	15.9	1972	1774	124
		750	33.2	24.9	2786	2639	112
		1000	34.4	34.4	3562	3367	103
BXRC-35E2000-B-7x	80	113	33.2	3.7	742	680	199
		225	34.0	7.7	1436	1303	188
		450	34.8	15.7	2725	2452	174
		675	35.6	24.1	3938	3449	164
		900	36.1	32.5	5023	4315	154
BXRC-35E2000-C-7x	80	158	33.2	5.2	1031	974	197
		315	34.0	10.7	1995	1879	186
		630	34.8	21.9	3815	3433	174
		945	35.6	33.7	5475	5119	163
		1260	36.1	45.5	6988	6511	153
BXRC-35E2000-D-7x	80	125	29.6	3.7	732	699	198
		250	30.3	7.6	1420	1352	187
		500	31.8	15.9	2767	2490	174
		750	33.2	24.9	3910	3704	157
		1000	34.4	34.4	4999	4724	145

Notes for Table 5:

1. Alternate drive currents are provided for reference only and are not a guarantee of performance.
2. Bridgelux maintains a ± 7% tolerance on flux measurements.
3. Typical stabilized DC performance values are provided as reference only and are not a guarantee of performance.

Performance at Commonly Used Drive Currents

Table 5: Product Performance at Commonly Used Drive Currents (Continued)

Part Number	CRI	Drive Current ¹ (mA)	Typical V _f T _c = 25°C (V)	Typical Power T _c = 25°C (W)	Typical Flux ² T _c = 25°C (lm)	Typical DC Flux ³ T _c = 85°C (lm)	Typical Efficacy T _c = 25°C (lm/W)
BXRC-35G2000-B-7x	90	113	33.2	3.7	610	559	163
		225	34.0	7.7	1180	1071	154
		450	34.8	15.7	2239	2015	143
		675	35.6	24.1	3236	2834	135
		900	36.1	32.5	4128	3546	127
BXRC-35G2000-C-7x	90	158	33.2	5.2	847	801	162
		315	34.0	10.7	1640	1544	153
		630	34.8	21.9	3135	2822	143
		945	35.6	33.7	4500	4207	134
		1260	36.1	45.5	5743	5351	126
BXRC-35G2000-D-7x	90	125	29.6	3.7	602	575	163
		250	30.3	7.6	1167	1111	154
		500	31.8	15.9	2274	2046	143
		750	33.2	24.9	3213	3044	129
		1000	34.4	34.4	4108	3882	119
BXRC-35A2001-B-7x	93	113	33.2	3.7	563	516	151
		225	34.0	7.7	1090	988	142
		450	34.8	15.7	2067	1860	132
		675	35.6	24.1	2987	2616	124
		900	36.1	32.5	3811	3273	117
BXRC-35A2001-C-7x	93	158	33.2	5.2	782	739	149
		315	34.0	10.7	1514	1425	141
		630	34.8	21.9	2894	2605	132
		945	35.6	33.7	4154	3883	123
		1260	36.1	45.5	5301	4940	116
BXRC-35A2001-D-7x	93	125	29.6	3.7	556	531	150
		250	30.3	7.6	1077	1026	142
		500	31.8	15.9	2099	1889	132
		750	33.2	24.9	2966	2810	119
		1000	34.4	34.4	3792	3584	110
BXRC-40C2001-B-7x	70	113	33.2	3.7	780	715	209
		225	34.0	7.7	1511	1370	197
		450	34.8	15.7	2866	2579	183
		675	35.6	24.1	4141	3627	172
		900	36.1	32.5	5283	4538	162
BXRC-40C2001-C-7x	70	158	33.2	5.2	1084	1025	207
		315	34.0	10.7	2099	1976	196
		630	34.8	21.9	4012	3611	183
		945	35.6	33.7	5759	5383	171
		1260	36.1	45.5	7350	6848	161
BXRC-40C2001-D-7x	70	125	29.6	3.7	770	736	209
		250	30.3	7.6	1493	1422	197
		500	31.8	15.9	2910	2619	183
		750	33.2	24.9	4112	3895	165
		1000	34.4	34.4	5258	4968	153

Notes for Table 5:

1. Alternate drive currents are provided for reference only and are not a guarantee of performance.
2. Bridgelux maintains a ± 7% tolerance on flux measurements.
3. Typical stabilized DC performance values are provided as reference only and are not a guarantee of performance.

Performance at Commonly Used Drive Currents

Table 5: Product Performance at Commonly Used Drive Currents (Continued)

Part Number	CRI	Drive Current ¹ (mA)	Typical V _f T _c = 25°C (V)	Typical Power T _c = 25°C (W)	Typical Flux ² T _c = 25°C (lm)	Typical DC Flux ³ T _c = 85°C (lm)	Typical Efficacy T _c = 25°C (lm/W)
BXRC-40E2000-B-7x	80	113	33.2	3.7	746	684	200
		225	34.0	7.7	1445	1310	189
		450	34.8	15.7	2741	2466	175
		675	35.6	24.1	3960	3468	165
		900	36.1	32.5	5052	4339	155
BXRC-40E2000-C-7x	80	158	33.2	5.2	1037	980	198
		315	34.0	10.7	2007	1890	187
		630	34.8	21.9	3837	3453	175
		945	35.6	33.7	5507	5148	164
		1260	36.1	45.5	7028	6549	154
BXRC-40E2000-D-7x	80	125	29.6	3.7	737	703	199
		250	30.3	7.6	1428	1360	188
		500	31.8	15.9	2783	2504	175
		750	33.2	24.9	3932	3725	158
		1000	34.4	34.4	5028	4751	146
BXRC-40G2000-B-7x	90	113	33.2	3.7	623	571	167
		225	34.0	7.7	1205	1093	158
		450	34.8	15.7	2286	2058	146
		675	35.6	24.1	3304	2894	137
		900	36.1	32.5	4215	3620	130
BXRC-40G2000-C-7x	90	158	33.2	5.2	865	818	165
		315	34.0	10.7	1674	1577	156
		630	34.8	21.9	3201	2881	146
		945	35.6	33.7	4594	4295	136
		1260	36.1	45.5	5864	5464	129
BXRC-40G2000-D-7x	90	125	29.6	3.7	615	587	166
		250	30.3	7.6	1191	1135	157
		500	31.8	15.9	2321	2089	146
		750	33.2	24.9	3280	3108	132
		1000	34.4	34.4	4195	3964	122
BXRC-40H2000-B-7x	97	113	33.2	3.7	563	516	151
		225	34.0	7.7	1090	988	142
		450	34.8	15.7	2067	1860	132
		675	35.6	24.1	2987	2616	124
		900	36.1	32.5	3811	3273	117
BXRC-40H2000-C-7x	97	158	33.2	5.2	782	739	149
		315	34.0	10.7	1514	1425	141
		630	34.8	21.9	2894	2605	132
		945	35.6	33.7	4154	3883	123
		1260	36.1	45.5	5301	4940	116
BXRC-40H2000-D-7x	97	125	29.6	3.7	556	531	150
		250	30.3	7.6	1077	1026	142
		500	31.8	15.9	2099	1889	132
		750	33.2	24.9	2966	2810	119
		1000	34.4	34.4	3792	3584	110

Notes for Table 5:

1. Alternate drive currents are provided for reference only and are not a guarantee of performance.
2. Bridgelux maintains a ± 7% tolerance on flux measurements.
3. Typical stabilized DC performance values are provided as reference only and are not a guarantee of performance.

Performance at Commonly Used Drive Currents

Table 5: Product Performance at Commonly Used Drive Currents (Continued)

Part Number	CRI	Drive Current ¹ (mA)	Typical V _f T _c = 25°C (V)	Typical Power T _c = 25°C (W)	Typical Flux ² T _c = 25°C (lm)	Typical DC Flux ³ T _c = 85°C (lm)	Typical Efficacy T _c = 25°C (lm/W)
BXRC-40A2001-B-7x	93	113	33.2	3.7	610	559	163
		225	34.0	7.7	1180	1071	154
		450	34.8	15.7	2239	2015	143
		675	35.6	24.1	3236	2834	135
		900	36.1	32.5	4128	3546	127
BXRC-40A2001-C-7x	93	158	33.2	5.2	847	801	162
		315	34.0	10.7	1640	1544	153
		630	34.8	21.9	3135	2822	143
		945	35.6	33.7	4500	4207	134
		1260	36.1	45.5	5743	5351	126
BXRC-40A2001-D-7x	93	125	29.6	3.7	602	575	163
		250	30.3	7.6	1167	1111	154
		500	31.8	15.9	2274	2046	143
		750	33.2	24.9	3213	3044	129
		1000	34.4	34.4	4108	3882	119
BXRC-50C2001-B-7x	70	113	33.2	3.7	785	719	210
		225	34.0	7.7	1519	1378	199
		450	34.8	15.7	2881	2593	184
		675	35.6	24.1	4164	3647	173
		900	36.1	32.5	5312	4562	163
BXRC-50C2001-C-7x	70	158	33.2	5.2	1090	1030	208
		315	34.0	10.7	2110	1987	197
		630	34.8	21.9	4034	3631	184
		945	35.6	33.7	5790	5413	172
		1260	36.1	45.5	7390	6886	162
BXRC-50C2001-D-7x	70	125	29.6	3.7	774	740	210
		250	30.3	7.6	1501	1430	198
		500	31.8	15.9	2926	2633	184
		750	33.2	24.9	4134	3917	166
		1000	34.4	34.4	5286	4995	154
BXRC-50E2001-B-7x	80	113	33.2	3.7	755	692	202
		225	34.0	7.7	1461	1325	191
		450	34.8	15.7	2772	2495	177
		675	35.6	24.1	4006	3508	167
		900	36.1	32.5	5110	4389	157
BXRC-50E2001-C-7x	80	158	33.2	5.2	1048	991	200
		315	34.0	10.7	2030	1911	189
		630	34.8	21.9	3881	3492	177
		945	35.6	33.7	5570	5207	165
		1260	36.1	45.5	7109	6624	156
BXRC-50E2001-D-7x	80	125	29.6	3.7	745	711	202
		250	30.3	7.6	1444	1375	190
		500	31.8	15.9	2814	2533	177
		750	33.2	24.9	3977	3768	160
		1000	34.4	34.4	5085	4805	148

Notes for Table 5:

1. Alternate drive currents are provided for reference only and are not a guarantee of performance.
2. Bridgelux maintains a ± 7% tolerance on flux measurements.
3. Typical stabilized DC performance values are provided as reference only and are not a guarantee of performance.

Performance at Commonly Used Drive Currents

Table 5: Product Performance at Commonly Used Drive Currents (Continued)

Part Number	CRI	Drive Current ¹ (mA)	Typical V _f T _c = 25°C (V)	Typical Power T _c = 25°C (W)	Typical Flux ² T _c = 25°C (lm)	Typical DC Flux ³ T _c = 85°C (lm)	Typical Efficacy T _c = 25°C (lm/W)
BXRC-50G2001-B-7x	90	113	33.2	3.7	653	598	175
		225	34.0	7.7	1263	1145	165
		450	34.8	15.7	2396	2156	153
		675	35.6	24.1	3463	3032	144
		900	36.1	32.5	4417	3794	136
BXRC-50G2001-C-7x	90	158	33.2	5.2	906	857	173
		315	34.0	10.7	1755	1652	164
		630	34.8	21.9	3354	3019	153
		945	35.6	33.7	4815	4501	143
		1260	36.1	45.5	6145	5726	135
BXRC-50G2001-D-7x	90	125	29.6	3.7	644	615	174
		250	30.3	7.6	1248	1189	165
		500	31.8	15.9	2433	2189	153
		750	33.2	24.9	3438	3257	138
		1000	34.4	34.4	4396	4154	128
BXRC-57C2001-B-7x	70	113	33.2	3.7	763	700	204
		225	34.0	7.7	1478	1340	193
		450	34.8	15.7	2803	2523	179
		675	35.6	24.1	4051	3548	168
		900	36.1	32.5	5167	4438	159
BXRC-57C2001-C-7x	70	158	33.2	5.2	1060	1002	203
		315	34.0	10.7	2053	1933	192
		630	34.8	21.9	3924	3532	179
		945	35.6	33.7	5633	5266	167
		1260	36.1	45.5	7189	6698	158
BXRC-57C2001-D-7x	70	125	29.6	3.7	753	720	204
		250	30.3	7.6	1460	1391	193
		500	31.8	15.9	2846	2561	179
		750	33.2	24.9	4022	3810	162
		1000	34.4	34.4	5143	4860	149
BXRC-57E2001-B-7x	80	113	33.2	3.7	725	664	194
		225	34.0	7.7	1403	1273	183
		450	34.8	15.7	2662	2396	170
		675	35.6	24.1	3847	3369	160
		900	36.1	32.5	4907	4215	151
BXRC-57E2001-C-7x	80	158	33.2	5.2	1007	952	193
		315	34.0	10.7	1949	1836	182
		630	34.8	21.9	3727	3354	170
		945	35.6	33.7	5349	5001	159
		1260	36.1	45.5	6828	6362	150
BXRC-57E2001-D-7x	80	125	29.6	3.7	716	683	194
		250	30.3	7.6	1387	1321	183
		500	31.8	15.9	2703	2433	170
		750	33.2	24.9	3820	3619	153
		1000	34.4	34.4	4884	4615	142

Notes for Table 5:

1. Alternate drive currents are provided for reference only and are not a guarantee of performance.
2. Bridgelux maintains a ± 7% tolerance on flux measurements.
3. Typical stabilized DC performance values are provided as reference only and are not a guarantee of performance.

Performance at Commonly Used Drive Currents

Table 5: Product Performance at Commonly Used Drive Currents (Continued)

Part Number	CRI	Drive Current ¹ (mA)	Typical V_f $T_c = 25^\circ\text{C}$ (V)	Typical Power $T_c = 25^\circ\text{C}$ (W)	Typical Flux ² $T_c = 25^\circ\text{C}$ (lm)	Typical DC Flux ³ $T_c = 85^\circ\text{C}$ (lm)	Typical Efficacy $T_c = 25^\circ\text{C}$ (lm/W)
BXRC-65C2001-B-7x	70	113	33.2	3.7	763	700	204
		225	34.0	7.7	1478	1340	193
		450	34.8	15.7	2803	2523	179
		675	35.6	24.1	4051	3548	168
		900	36.1	32.5	5167	4438	159
BXRC-65C2001-C-7x	70	158	33.2	5.2	1060	1002	203
		315	34.0	10.7	2053	1933	192
		630	34.8	21.9	3924	3532	179
		945	35.6	33.7	5633	5266	167
		1260	36.1	45.5	7189	6698	158
BXRC-65C2001-D-7x	70	125	29.6	3.7	753	720	204
		250	30.3	7.6	1460	1391	193
		500	31.8	15.9	2846	2561	179
		750	33.2	24.9	4022	3810	162
		1000	34.4	34.4	5143	4860	149
BXRC-65E2001-B-7x	80	113	33.2	3.7	734	672	196
		225	34.0	7.7	1420	1288	186
		450	34.8	15.7	2694	2424	172
		675	35.6	24.1	3893	3409	162
		900	36.1	32.5	4965	4265	153
BXRC-65E2001-C-7x	80	158	33.2	5.2	1019	963	195
		315	34.0	10.7	1972	1857	184
		630	34.8	21.9	3771	3394	172
		945	35.6	33.7	5412	5060	161
		1260	36.1	45.5	6908	6437	152
BXRC-65E2001-D-7x	80	125	29.6	3.7	724	691	196
		250	30.3	7.6	1403	1337	185
		500	31.8	15.9	2735	2461	172
		750	33.2	24.9	3865	3661	155
		1000	34.4	34.4	4942	4670	144

Notes for Table 5:

1. Alternate drive currents are provided for reference only and are not a guarantee of performance.
2. Bridgelux maintains a $\pm 7\%$ tolerance on flux measurements.
3. Typical stabilized DC performance values are provided as reference only and are not a guarantee of performance.

Electrical Characteristics

Table 6: Electrical Characteristics

Part Number	Drive Current (mA)	Forward Voltage Pulsed, $T_c = 25^\circ\text{C}$ (V) ^{1, 2, 3, 8}			Typical Coefficient of Forward Voltage ⁴ $\Delta V_f / \Delta T_c$ (mV/ $^\circ\text{C}$)	Typical Thermal Resistance Junction to Case ^{5,6} R_{j-c} ($^\circ\text{C}/\text{W}$)	Driver Selection Voltages ⁷ (V)	
		Minimum	Typical	Maximum			V_f Min. Hot $T_c = 105^\circ\text{C}$ (V)	V_f Max. Cold $T_c = -40^\circ\text{C}$ (V)
BXRC-xxx200x-B-7x	450	32.2	34.8	37.4	-14.3	0.28	31.0	38.3
	900	33.4	36.1	38.8	-14.3	0.35	32.2	39.7
BXRC-xxx200x-C-7x	630	32.2	34.8	37.4	-14.3	0.20	31.0	38.3
	1260	33.4	36.1	38.8	-14.3	0.24	32.2	39.7
BXRC-xxx200x-D-7x	500	29.4	31.8	34.2	-13.3	0.34	28.4	35.0
	1000	31.8	34.4	37.0	-13.3	0.41	30.8	37.9

Notes for Table 6:

- Parts are tested in pulsed conditions, $T_c = 25^\circ\text{C}$. Pulse width is 10ms.
- Voltage minimum and maximum are provided for reference only and are not a guarantee of performance.
- Bridgelux maintains a tester tolerance of $\pm 0.10\text{V}$ on forward voltage measurements.
- Typical coefficient of forward voltage tolerance is $\pm 0.1\text{mV}$ for nominal current.
- Thermal resistance values are based from test data of a 3000K 80 CRI product.
- Thermal resistance value was calculated using total electrical input power; optical power was not subtracted from input power. The thermal interface material used during testing is not included in the thermal resistance value.
- V_f min hot and max cold values are provided as reference only and are not guaranteed by test. These values are provided to aid in driver design and selection over the operating range of the product.
- This product has been designed and manufactured per IEC 62031:2018. This product has passed dielectric withstand voltage testing at 1160 V. The working voltage designated for the insulation is 80V d.c. The maximum allowable voltage across the array must be determined in the end product application.

Eye Safety

Table 7: Eye Safety Risk Group (RG) Classifications

Part Number	Drive Current ⁵ (mA)	CCT ⁵			
		2700K/3000K	4000K ²	5000K ³	6500K ⁴
BXRC-xxx200x-B-7x	450	RG1	RG1	RG1	RG1
	675	RG1	RG1	RG1	RG2
	900	RG1	RG1	RG2	RG2
BXRC-xxx200x-C-7x	630	RG1	RG1	RG1	RG1
	945	RG1	RG1	RG2	RG2
	1260	RG1	RG2	RG2	RG2
BXRC-xxx200x-D-7x	500	RG1	RG1	RG1	RG1
	750	RG1	RG1	RG1	RG2
	1000	RG1	RG1	RG2	RG2

Notes for Table 7:

1. Eye safety classification for the use of Bridgelux Vero Series LED arrays is in accordance with specification IEC/TR 62778: Application of IEC 62471 for the assessment of blue light hazard to light sources and luminaires.
2. For products classified as RG2 at 4000K, $E_{thr} = 1847.5$ lx.
3. For products classified as RG2 at 5000K $E_{thr} = 1315.8$ lx.
4. For products classified as RG2 at 6500K, $E_{thr} = 1124.5$ lx.
5. Please contact your Bridgelux sales representative for E_{thr} values at specific drive currents and CCTs not listed.

Absolute Maximum Ratings

Table 8: Maximum Ratings

Parameter	Maximum Rating		
LED Junction Temperature (T_j)	150°C		
Storage Temperature	-40°C to +105°C		
Operating Case Temperature ¹ (T_c)	105°C		
Soldering Temperature ²	300°C or lower for a maximum of 6 seconds		
	BXRC-xxx200x-B-7x	BXRC-xxx200x-C-7x	BXRC-xxx200x-D-7x
Maximum Drive Current ³	900mA	1260mA	1000mA
Maximum Peak Pulsed Drive Current ⁴	1290mA	1800mA	1430mA
Maximum Reverse Voltage ⁵	-60V	-60V	-55V

Notes for Table 8:

1. For IEC 62717 requirement, please consult your Bridgelux sales representative.
2. Refer to Bridgelux Application Note AN31: Assembly Considerations for Bridgelux Vero LED Arrays.
3. Arrays may be driven at higher currents however lumen maintenance may be reduced.
4. Bridgelux recommends a maximum duty cycle of 10% and pulse width of 20 ms when operating LED Arrays at maximum peak pulsed current specified. Maximum peak pulsed currents indicate values where LED Arrays can be driven without catastrophic failures.
5. Light emitting diodes are not designed to be driven in reverse voltage and will not produce light under this condition. Maximum rating provided for reference only.

Performance Curves

Figure 1: Vero 13B Drive Current vs. Voltage

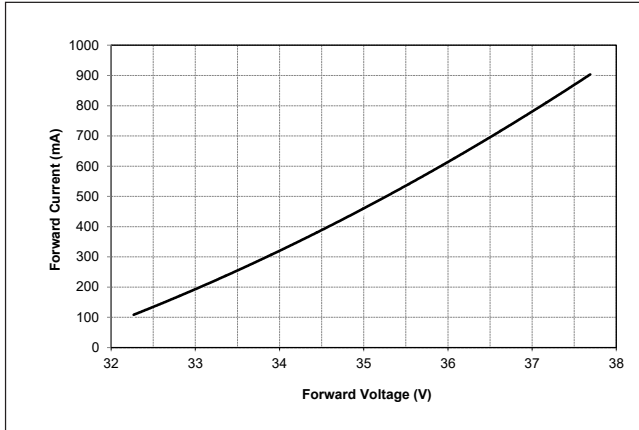

Figure 2: Vero 13C Drive Current vs. Voltage

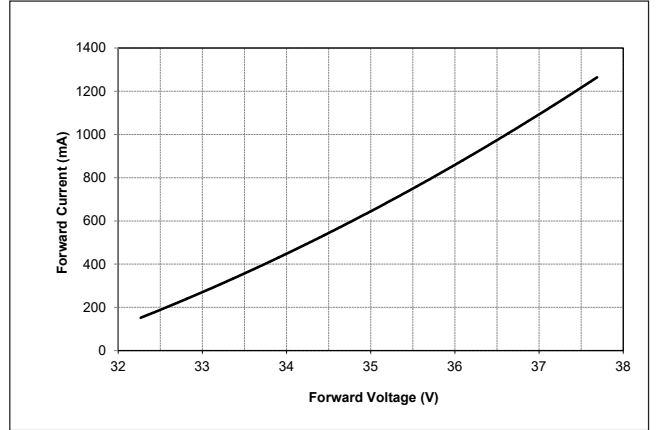

Figure 3: Vero 13D Drive Current vs. Voltage

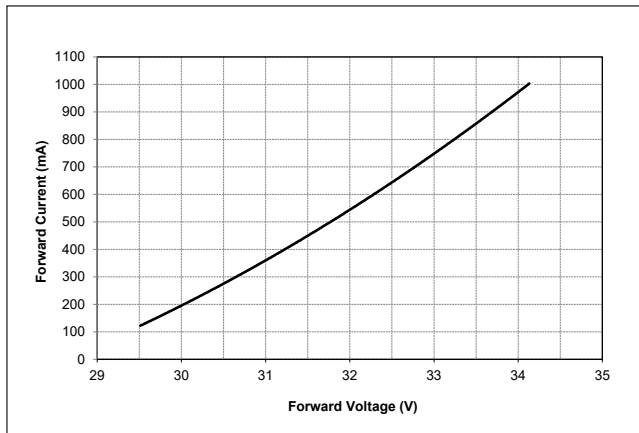

Figure 4: Vero 13B Typical Relative Flux vs. Current

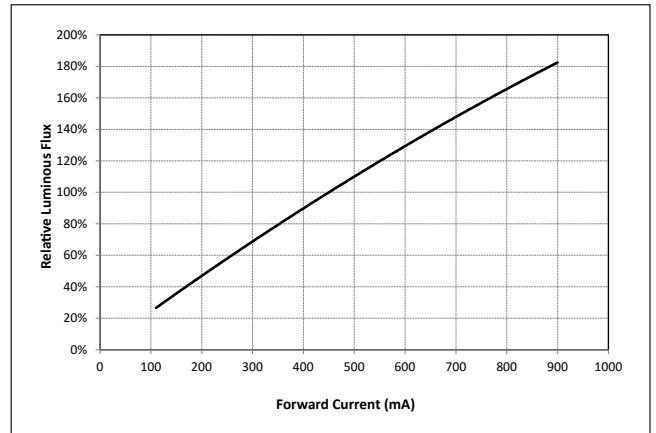

Figure 5: Vero 13C Typical Relative Flux vs. Current

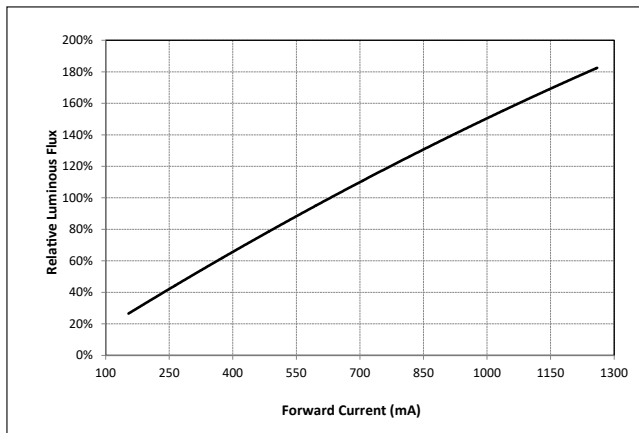
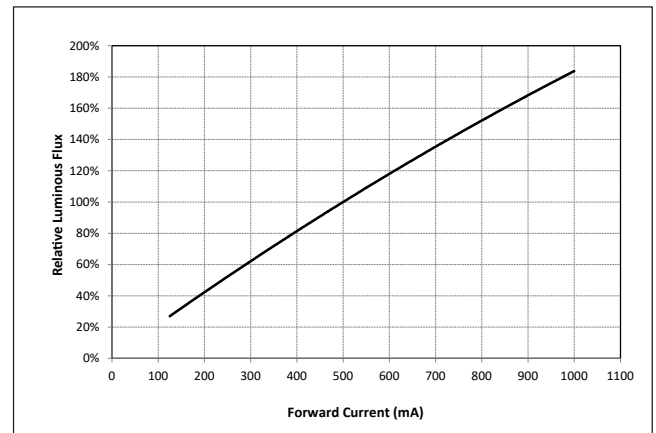

Figure 6: Vero 13D Typical Relative Flux vs. Current



Notes for Figure 1-6:

1. Bridgelux does not recommend driving high power LEDs at low currents. Doing so may produce unpredictable results. Pulse width modulation (PWM) is recommended for dimming effects.
2. Products tested under pulsed condition (10ms pulse width) at nominal test current where T_j (junction temperature) - T_c (case temperature) = 25°C.

Performance Curves

Figure 7: Typical DC Flux vs. Case Temperature

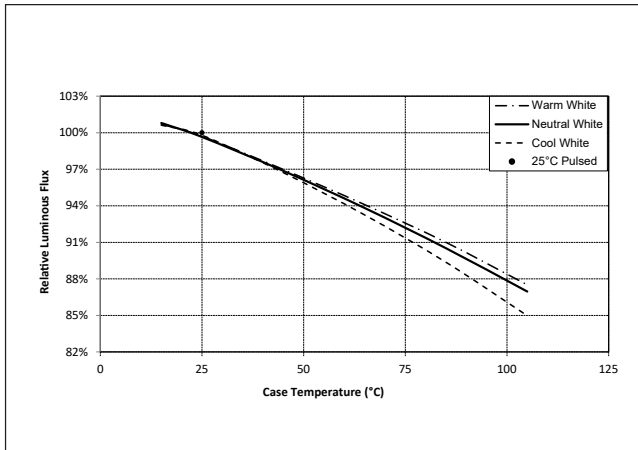

Figure 8: Typical DC ccy Shift vs. Case Temperature

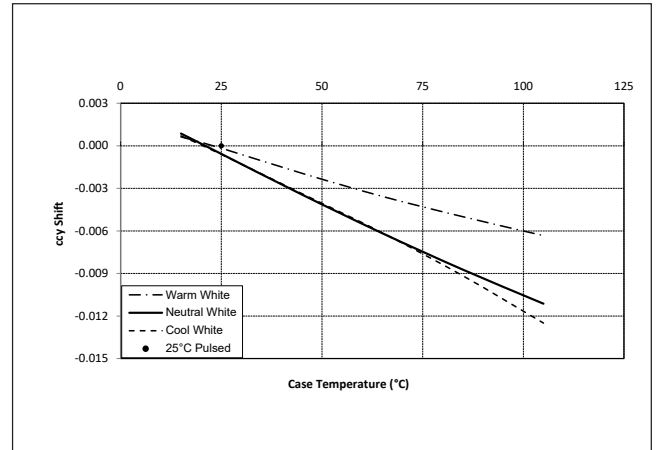
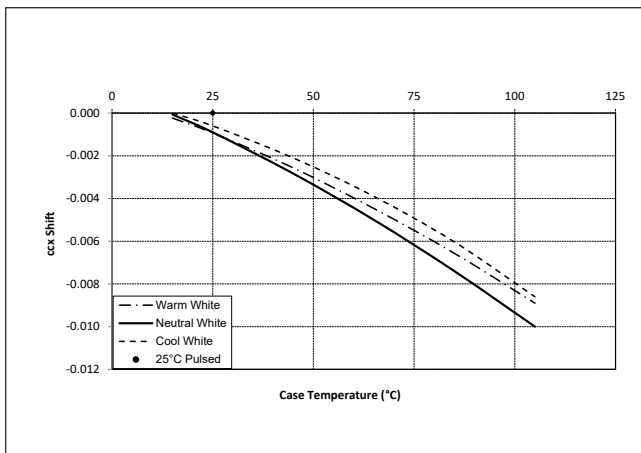

Figure 9: Typical DC ccx Shift vs. Case Temperature



Notes for Figures 7-9:

1. Characteristics shown for warm white based on 3000K and 80 CRI.
2. Characteristics shown for neutral white based on 4000K and 80 CRI.
3. Characteristics shown for cool white based on 5000K and 70 CRI.
4. For other color SKUs, the shift in color will vary. Please contact your Bridgelux Sales Representative for more information.

Performance Curves

Figure 10: 2700K, 97 CRI Color Shift vs. Case Temperature¹

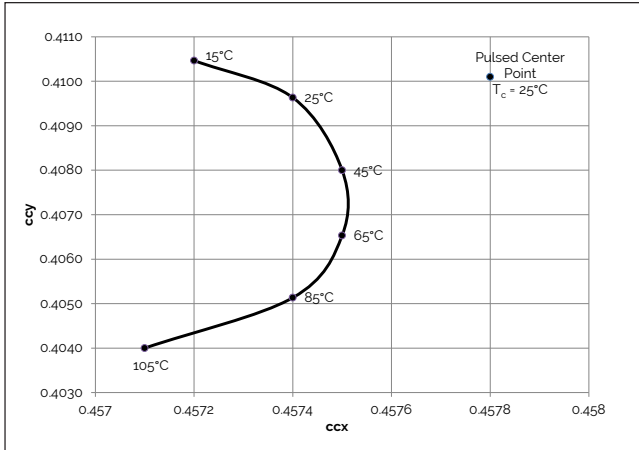

Figure 11: 3000K, 97 CRI Color Shift vs. Case Temperature¹

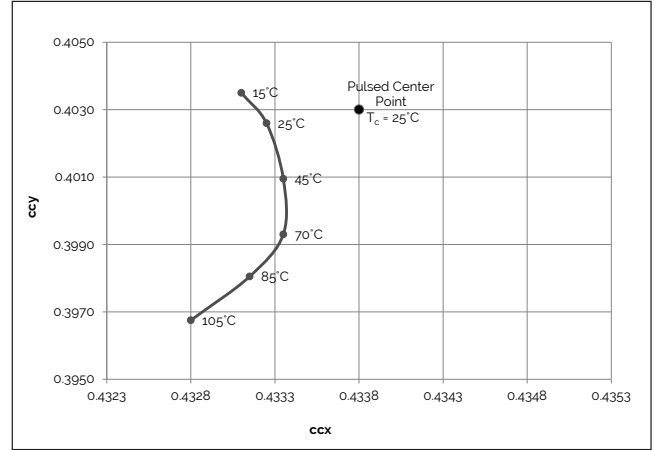

Figure 12: 3000K, 90 CRI Color Shift vs. Case Temperature¹

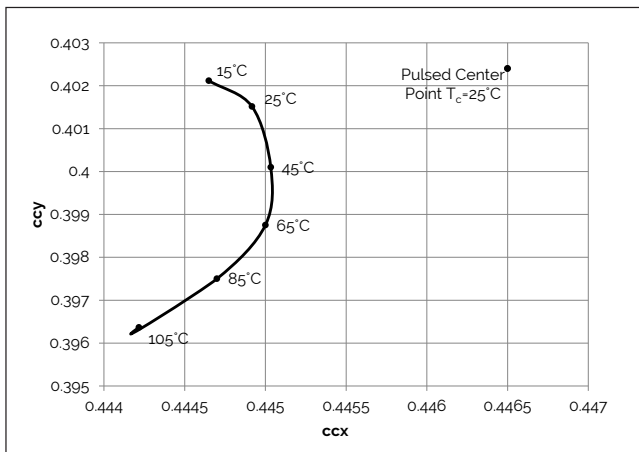

Figure 13: 3000K Class A Color Shift vs. Case Temperature¹

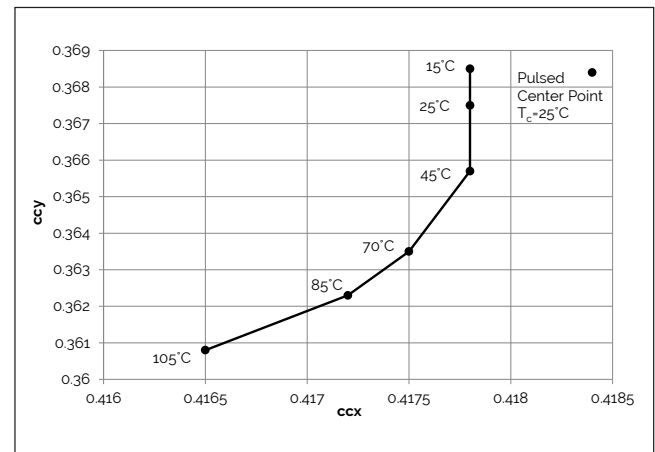

Figure 14: 3500K Class A Color Shift vs. Case Temperature¹

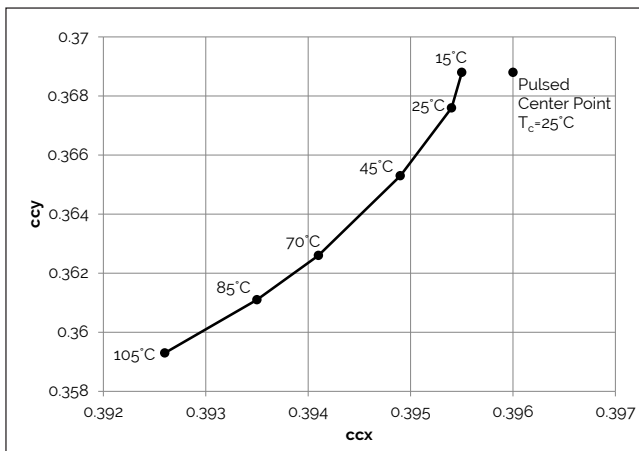
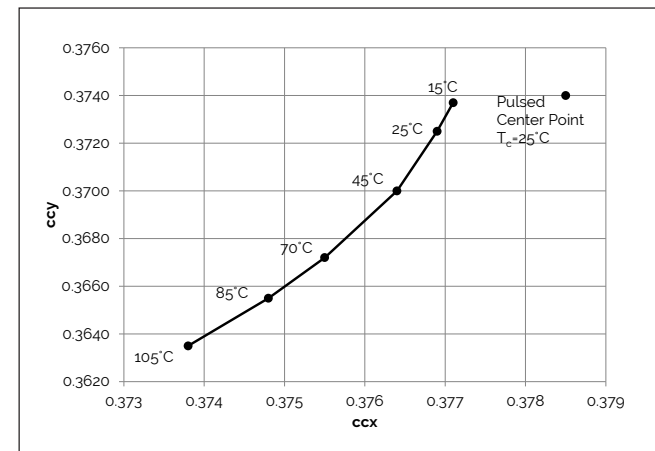

Figure 15: 4000K Class A Color Shift vs. Case Temperature¹



Notes for Figures 10-15:

1. Measurements made under DC test conditions at the nominal drive current.
2. Typical color shift is shown with a tolerance of ± 0.002 .
3. Characteristics shown for Decor Series Showcase products, BXRC-30G200C-x-73

Typical Radiation Pattern

Figure 16: Typical Spatial Radiation Pattern

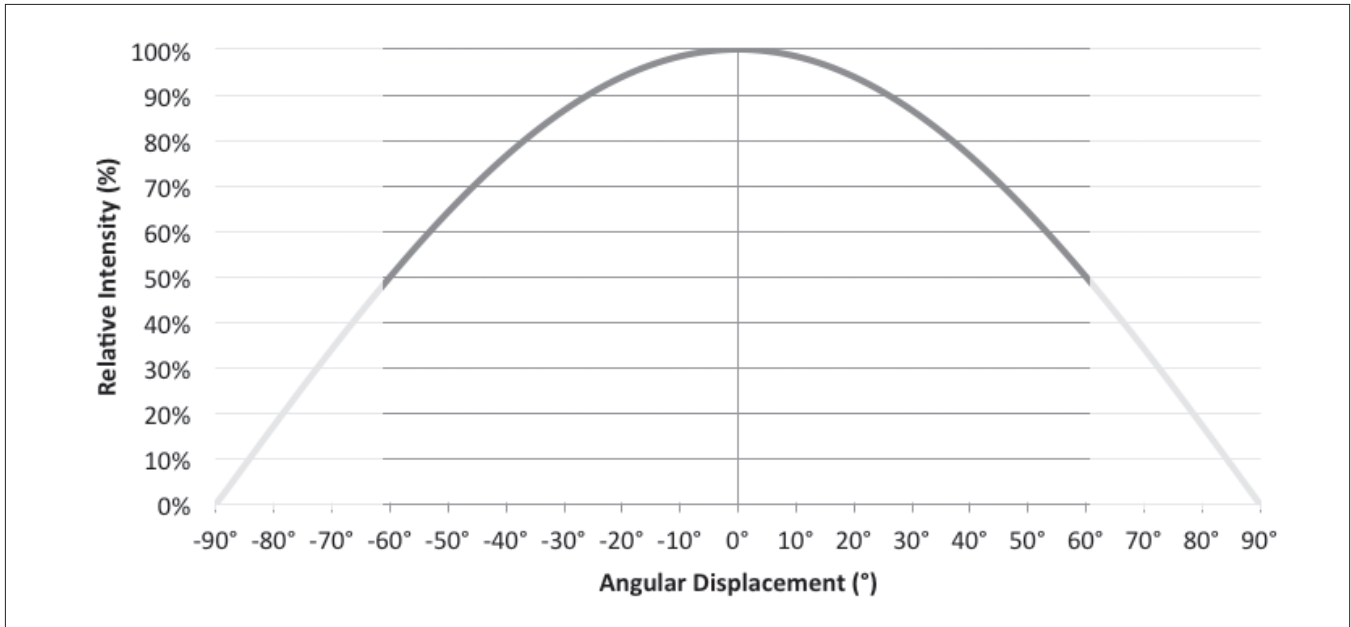

Notes for Figure 16:

1. Typical viewing angle is 120°.
2. The viewing angle is defined as the off axis angle from the centerline where intensity is ½ of the peak value.

Figure 17: Typical Polar Radiation Pattern

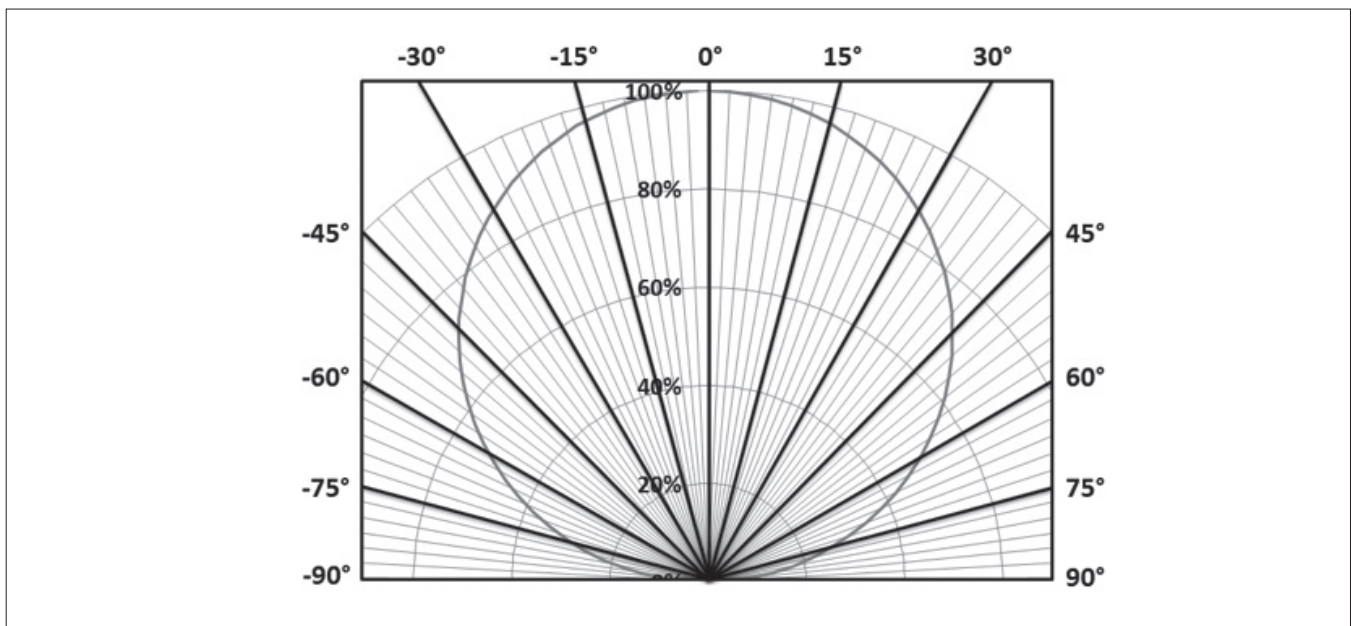

Typical Color Spectrum

Figure 18: Typical Color Spectrum

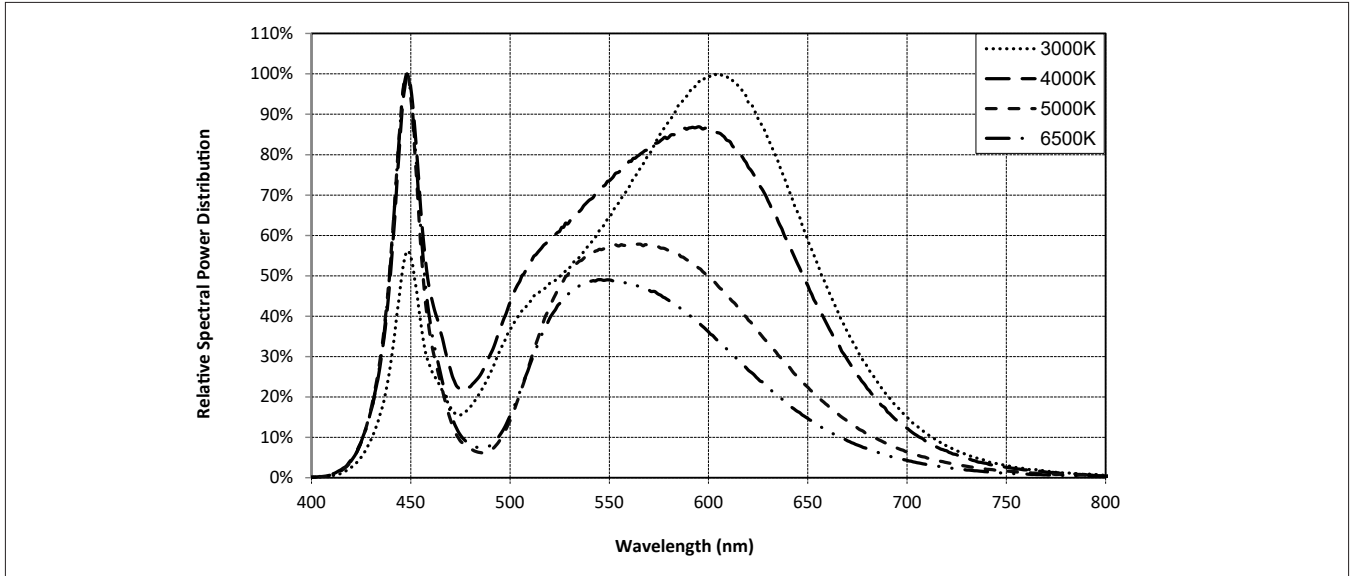

Notes for Figure 18:

1. Color spectra measured at nominal current for $T_j = T_c = 25^\circ\text{C}$.
2. Color spectra shown is 3000K and 80 CRI.
3. Color spectra shown is 4000K and 80 CRI.
4. Color spectra shown is 5000K and 70 CRI.
4. Color spectra shown is 6500K and 70 CRI.

Figure 19: Typical Color Spectrum for Vero 13 with Décor Series

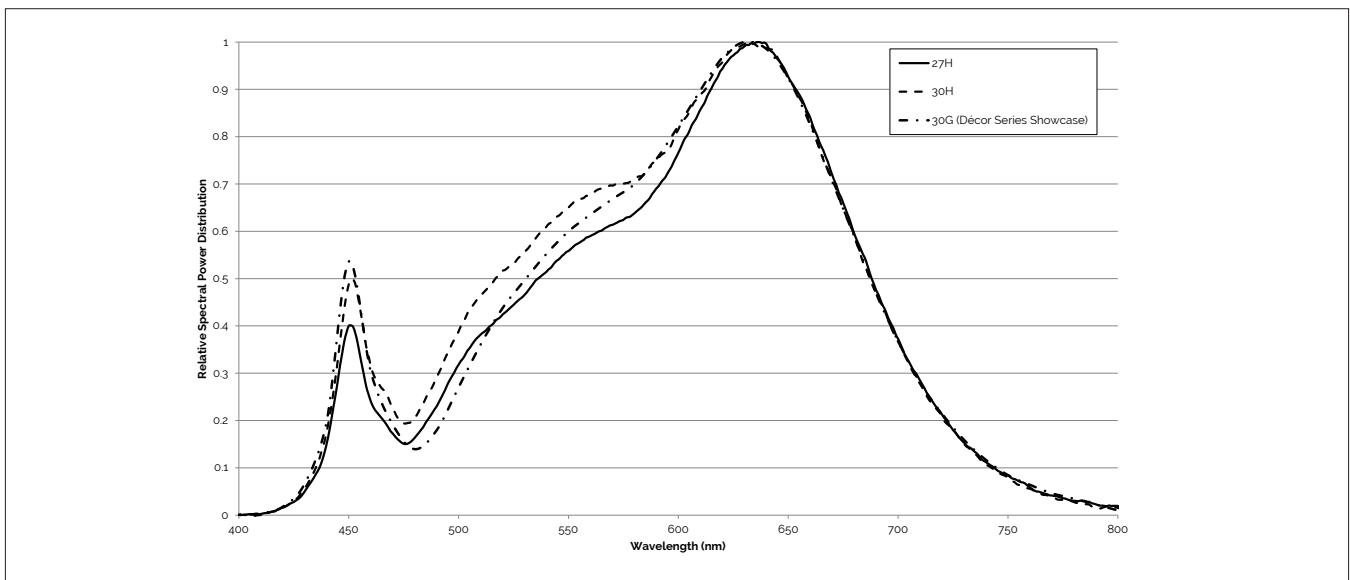

Note for Figure 19:

1. Color spectra measured at nominal current for $T_j = T_c = 25^\circ\text{C}$.

Mechanical Dimensions

Figure 20: Drawing for Vero 13 LED Array

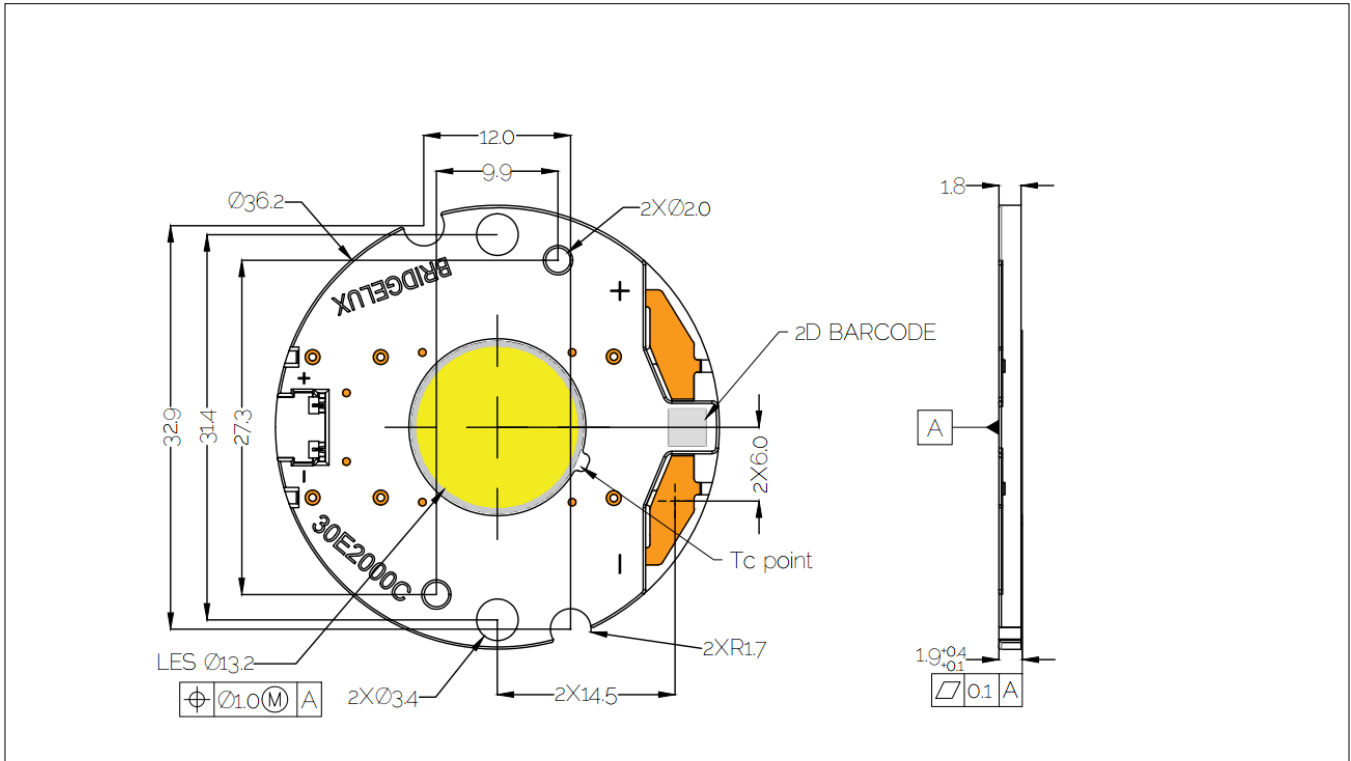

Notes for Figure 20:

1. Drawings are not to scale.
2. Drawing dimensions are in millimeters.
3. Unless otherwise specified, tolerances are $\pm 0.1\text{mm}$.
4. Mounting holes (2X) are for M2.5 screws.
5. Bridgelux recommends two tapped holes for mounting screws with $31.4 \pm 0.10\text{mm}$ center-to-center spacing.
6. Screws with flat shoulders (pan, dome, button, round, truss, mushroom) provide optimal torque control. Do NOT use flat, countersink, or raised head screws.
7. Solder pads and connector port are labeled "+" and "-" to denote positive and negative, respectively.
8. It is not necessary to provide electrical connections to both the solder pads and the connector port. Either set may be used depending on application specific design requirements.
9. Refer to Application Notes AN30 and AN31 for product handling, mounting and heat sink recommendations.
10. The optical center of the LED Array is nominally defined by the mechanical center of the array to a tolerance of $\pm 0.2\text{mm}$.
11. Bridgelux maintains a flatness of 0.10mm across the mounting surface of the array.

Color Binning Information

Figure 21: Warm and Neutral White Test Bins in xy Color Space

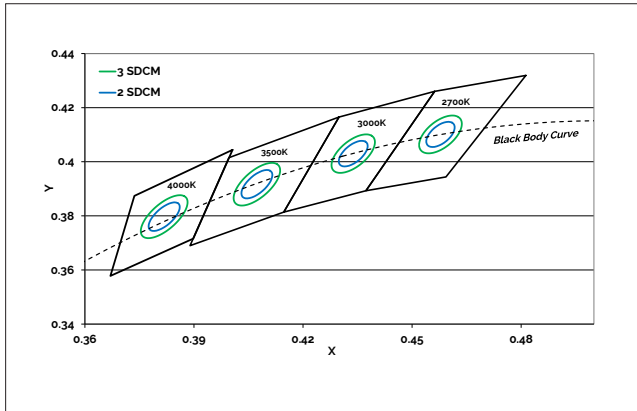

Note: Pulsed Test Conditions, $T_c = 25^\circ\text{C}$

Figure 22: Cool White Test Bins in xy Color Space

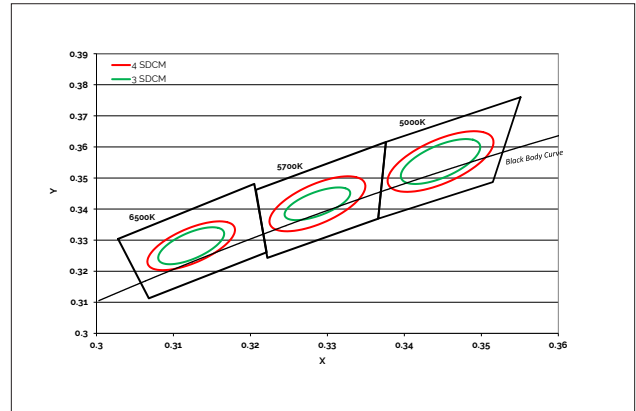

Note: Pulsed Test Conditions, $T_c = 25^\circ\text{C}$

Table 9: Warm and Neutral White xy Bin Coordinates and Associated Typical CCT

Bin Code	2700K	3000K ¹	3500K ¹	4000K ¹
ANSI Bin (for reference only)	(2580K - 2870K)	(2870K - 3220K)	(3220K - 3710K)	(3710K - 4260K)
73 (3 SDCM)	(2651K - 2794K)	(2968K - 3136K)	(3369K - 3586K)	(3851K - 4130K)
72 (2 SDCM)	(2674K - 2769K)	(2995K - 3107K)	(3404K - 3548K)	(3895K - 4081K)
Center Point (x,y)	(0.4578, 0.4101)	(0.4338, 0.403) (0.4465, 0.4024) ²	(0.4073, 0.3917)	(0.3818, 0.3797)

Notes for Table 9:

- Color Binning information excludes Décor Series Class A products. Please contact your Bridgelux Sales Representative for more information.
- Center Point for Decor Series Showcase.
- Bridgelux maintains a tolerance of +/- 0.007 on x and y color coordinates in the CIE 1931 color Space.

Table 10: Cool White xy Bin Coordinates and Associated Typical CCT (product is hot targeted to $T_c = 85^\circ\text{C}$)

Bin Code	5000K	5700K	6500K
ANSI Bin (for reference only)	(4745K - 5311K)	(5312K - 6022K)	(6022K - 7042K)
74 (4 SDCM)	(4801K - 5282K)	(5395K - 5970K)	(6200K - 6910K)
73 (3 SDCM)	(4835K - 5215K)	(5460K - 5891K)	(6279K - 6811K)
Center Point (x,y)	(0.3447, 0.3553)	(0.3287, 0.3417)	(0.3123, 0.3282)

Note for Tables 10:

- Bridgelux maintains a tolerance of +/- 0.007 on x and y color coordinates in the CIE 1931 color Space.

Packaging and Labeling

Figure 23: Drawing for Vero 13 Packaging Tray

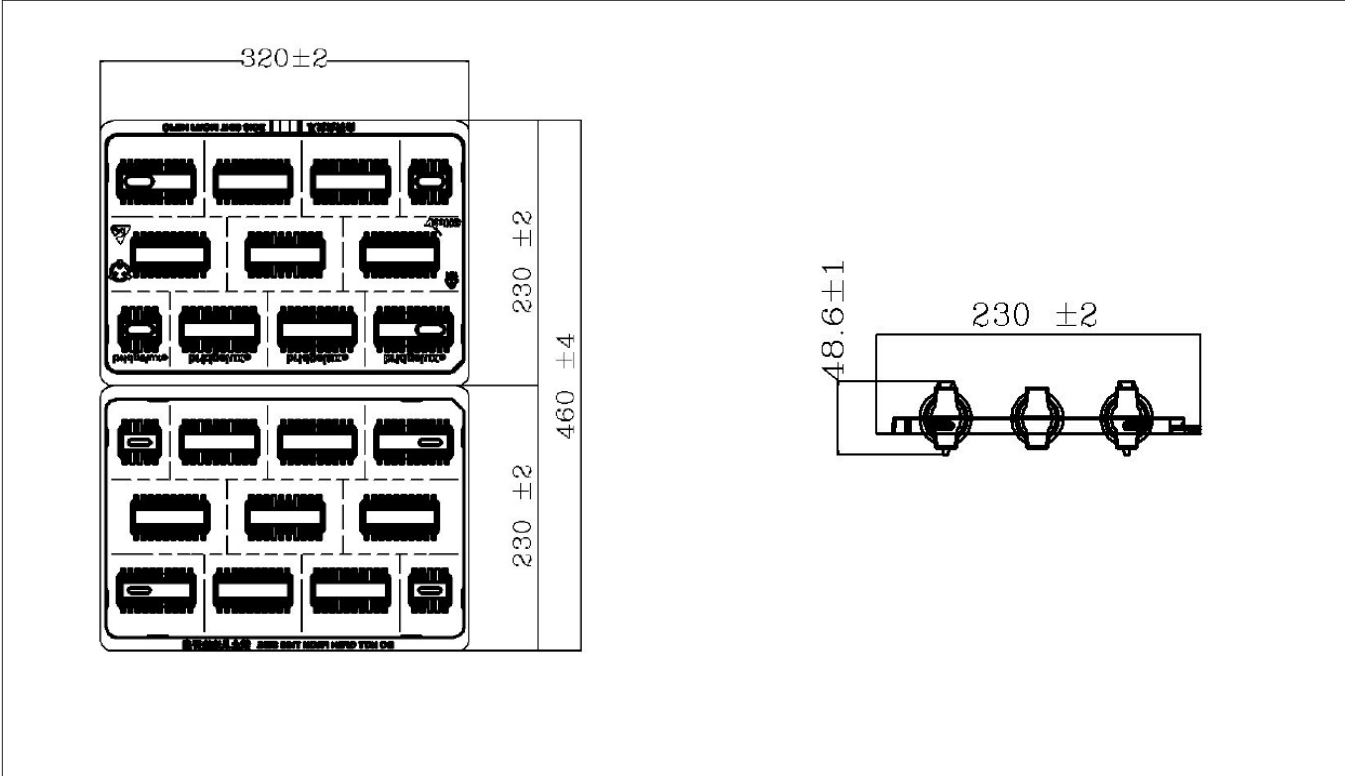

- Notes for Figure 23:
- 1. Dimensions are in millimeters.
 - 2. Drawings are not to scale.

Packaging and Labeling

Figure 24: Vero Series Packaging and Labeling

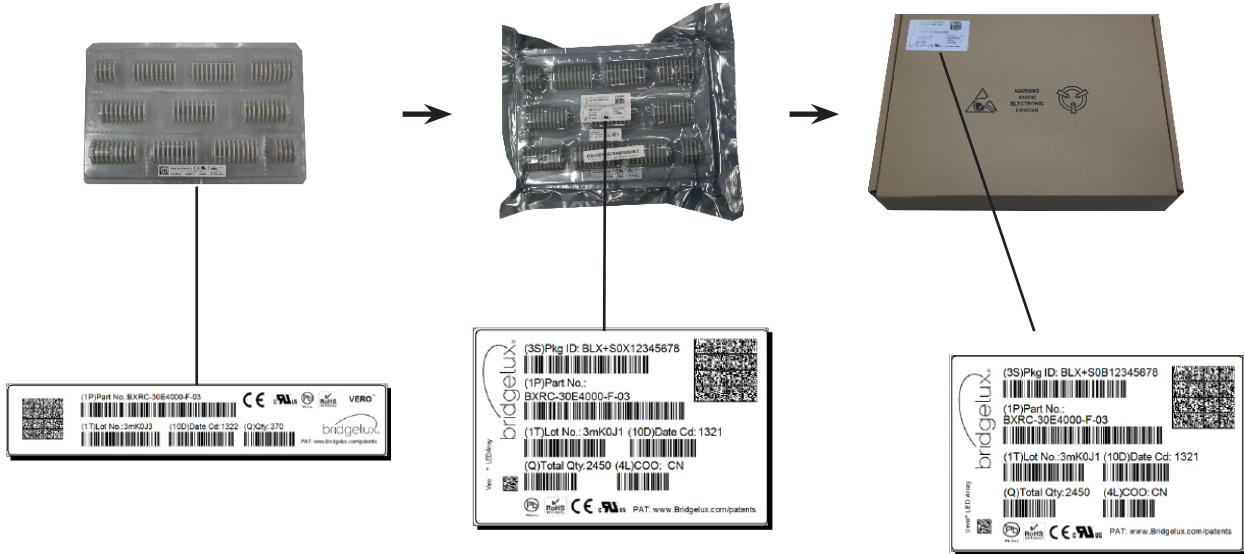

Notes for Figure 24:

1. Each tray holds 100 COBs.
2. Each tray is vacuum sealed in an anti-static bag and placed in its own box.
3. Each tray, bag and box is to be labeled as shown above.

Figure 25: Gen. 7 Product Labeling

Bridgelux COB arrays have laser markings on the back side of the substrate to help with product identification. In addition to the product identification markings, Bridgelux COB arrays also contain markings for internal Bridgelux manufacturing use only. The image below shows which markings are for customer use and which ones are for Bridgelux internal use only. The Bridgelux internal manufacturing markings are subject to change without notice, however these will not impact the form, function or performance of the COB array.



Customer Use- 2D Barcode
Scannable barcode provides product part number and other Bridgelux internal production information.

Customer Use- Product part number

30E2000C 73 2F

Customer Use- V_i Bin Code included to enable greater luminaire design flexibility. Refer to ANg2 for bin code definitions.

Design Resources

Application Notes

Bridgelux has developed a comprehensive set of application notes and design resources to assist customers in successfully designing with the Vero product family of LED array products. For all available application notes visit www.bridgelux.com.

Optical Source Models

Optical source models and ray set files are available for all Bridgelux products. For a list of available formats, visit www.bridgelux.com.

3D CAD Models

Three dimensional CAD models depicting the product outline of all Bridgelux Vero LED arrays are available in both IGS and STEP formats. Please contact your Bridgelux sales representative for assistance.

LM80

LM80 testing has been completed and the LM80 report is now available. Please contact your Bridgelux sales representative for LM-80 report.

Precautions

CAUTION: CHEMICAL EXPOSURE HAZARD

Exposure to some chemicals commonly used in luminaire manufacturing and assembly can cause damage to the LED array. Please consult Bridgelux Application Note AN31 for additional information.

CAUTION: RISK OF BURN

Do not touch the Vero LED array during operation. Allow the array to cool for a sufficient period of time before handling. The Vero LED array may reach elevated temperatures such that could burn skin when touched.

CAUTION

CONTACT WITH LIGHT EMITTING SURFACE (LES)

Avoid any contact with the LES. Do not touch the LES of the LED array or apply stress to the LES (yellow phosphor resin area). Contact may cause damage to the LED array.

Optics and reflectors must not be mounted in contact with the LES (yellow phosphor resin area). Optical devices may be mounted on the top surface of the plastic housing of the Vero LED array. Use the mechanical features of the LED array housing, edges and/or mounting holes to locate and secure optical devices as needed.

Disclaimers

MINOR PRODUCT CHANGE POLICY

The rigorous qualification testing on products offered by Bridgelux provides performance assurance. Slight cosmetic changes that do not affect form, fit, or function may occur as Bridgelux continues product optimization.

STANDARD TEST CONDITIONS

Unless otherwise stated, array testing is performed at the nominal drive current.

About Bridgelux: Bridging Light and Life™

At Bridgelux, we help companies, industries and people experience the power and possibility of light. Since 2002, we've designed LED solutions that are high performing, energy efficient, cost effective and easy to integrate. Our focus is on light's impact on human behavior, delivering products that create better environments, experiences and returns—both experiential and financial. And our patented technology drives new platforms for commercial and industrial luminaires.

For more information about the company, please visit
bridgelux.com
twitter.com/Bridgelux
facebook.com/Bridgelux
youtube.com/user/Bridgelux
linkedin.com/company/bridgelux-inc-_2
WeChat ID: BridgeluxInChina



46410 Fremont Boulevard
Fremont, CA 94538 U.S.A.
Tel (925) 583-8400
www.bridgelux.com