



Bridgelux® Gen. 7 V6 HD LED Array

Product Data Sheet DS401



Introduction

V Series HD



V Series™ HD LED array product, an ultra-high lumen density COB product line, is designed for high intensity spotlights used in commercial and retail settings. V Series HD arrays offer industry leading color over angle uniformity, and replace ceramic metal halide lamps by providing equal or greater center beam candle power at lower power and at greater lifetimes. Their tight beam control and exceptional quality of light is well suited for demanding directional spot applications.

The V6 HD LED array is available in a variety of CCT and CRI combinations providing substantial design flexibility and energy efficiencies.

Lighting system designs incorporating these LED arrays deliver increased system level efficacy and longer service life. Typical applications include, but are not limited to, commercial and residential down lights, accent, spot and track lights.

Bridgelux Décor Series™ is our state of the art color line designed specifically for premium applications, producing unmatched LED light quality with brilliant color-rendering options and offer pleasing and inspiring lighting palettes. Bridgelux Décor Series color points are available on Vero® SE Series, Vero® Series, V Series™ and V Series™ HD.

Décor Series Class A is based on human response testing, providing color points with a combined GAI and CRI metric.

Décor Series™ Ultra products provide a high CRI of 97 and a minimum R9 value of 91, which emphasizes the reds and color tones to which the human eye is most receptive - perfect for the most luxurious retail shops and world renowned museums. Décor Series Ultra is designed as a replacement for halogen.

Décor Series™ Showcase is the optimal solution for replacing ceramic metal halide lamps, incorporating the same pure white light with enhanced spectrum coverage and higher efficacy.

Features

- Efficacy of 125 lm/W typical, 3000K 80 CRI
- Compact high flux density light source
- Uniform high quality illumination
- Minimum 80, 90 and 95 CRI options
- Streamlined thermal path
- ENERGY STAR® / ANSI compliant color binning structure with 3 SDCM options
- More energy efficient than incandescent, halogen and fluorescent lamps
- Low voltage DC operation
- Instant light with unlimited dimming
- V_f bin code backside marking

Benefits

- Enhanced optical control
- Clean white light without pixelation
- High quality true color reproduction
- Significantly reduced thermal resistance and increased operating temperatures
- Uniform consistent white light
- Lower operating costs
- Easy to use with daylight and motion detectors to enable increased energy savings
- Reduced maintenance costs
- Environmentally friendly, no disposal issue



Contents

Product Feature Map	2
Product Nomenclature	2
Product Selection Guide	3
European Product Registry for Energy Labeling	5
Performance at Commonly Used Drive Currents	6
Electrical Characteristics	10
Eye Safety	11
Absolute Maximum Ratings	12
Performance Curves	13
Typical Radiation Pattern	15
Typical Color Spectrum	16
Mechanical Dimensions	17
Color Binning Information	18
Packaging and Labeling	19
Design Resources	21
Precautions	21
Disclaimers	21
About Bridgelux	22

Product Feature Map

Bridgelux arrays are fully engineered devices that provide consistent thermal and optical performance on an engineered mechanical platform. The V Series HD arrays are the most compact chip-on-board devices across all of

Bridgelux's LED array products. The arrays incorporate several features to simplify design integration and assembly. Please visit www.bridgelux.com for more information on the V Series HD family of products.

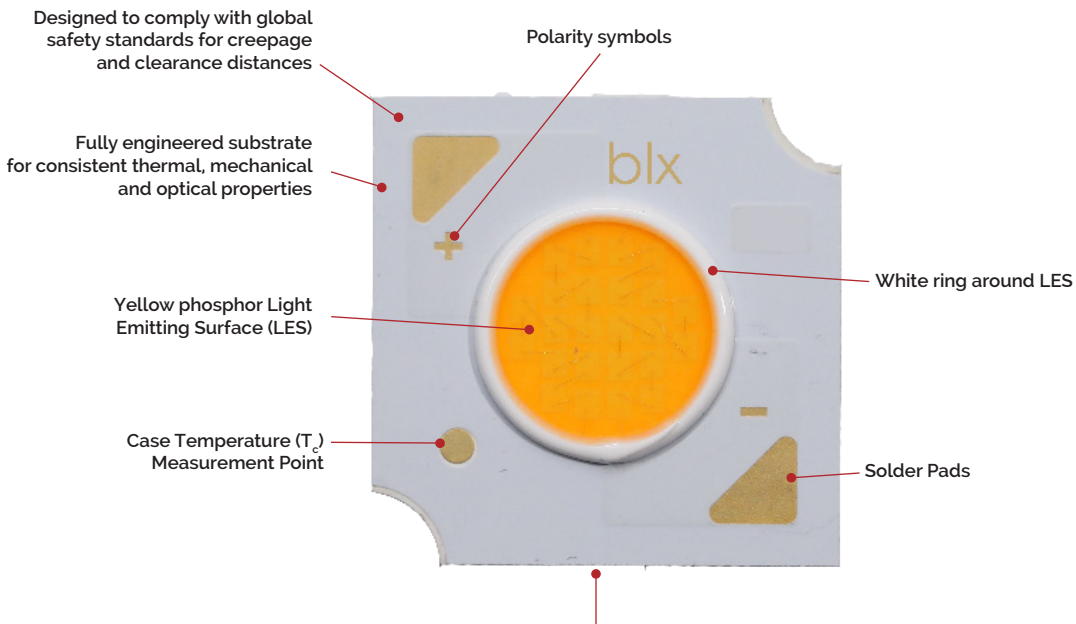

Note: Part number and lot codes are scribed on back of array

Product Nomenclature

The part number designation for Bridgelux V Series HD LED arrays is explained as follows:

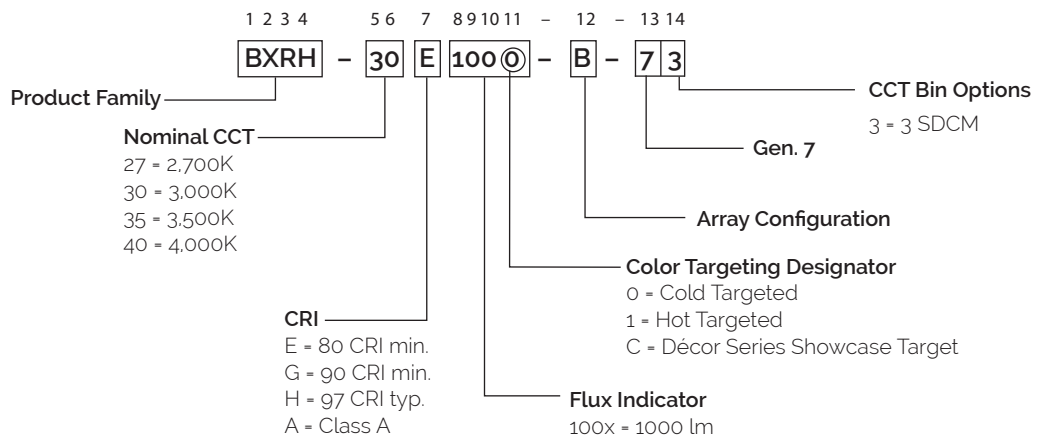

Product Selection Guide

The following product configurations are available:

Table 1: Selection Guide, Pulsed Measurement Data ($T_j = T_c = 25^\circ\text{C}$)

Part Number	Nominal CCT ¹ (K)	CRI ²	Nominal Drive Current ³ (mA)	Typical Pulsed Flux ^{4,5,6} $T_c = 25^\circ\text{C}$ (lm)	Minimum Pulsed Flux ^{6,7} $T_c = 25^\circ\text{C}$ (lm)	Typical V_f (V)	Typical Power (W)	Typical Efficacy (lm/W)
BXRH-27E1000-B-73	2700	80	350	1508	1297	36.4	12.7	118
BXRH-27E1000-G-73	2700	80	700	1508	1297	18.2	12.7	118
BXRH-27G1000-B-73	2700	90	350	1254	1078	36.4	12.7	98
BXRH-27G1000-G-73	2700	90	700	1254	1078	18.2	12.7	98
BXRH-27G10H0-B-73	2700	90	350	1385	1191	36.4	12.7	109
BXRH-27G10H0-G-73	2700	90	700	1385	1191	18.2	12.7	109
BXRH-27H1000-B-73	2700	97	350	1111	955	36.4	12.7	87
BXRH-27H1000-G-73	2700	97	700	1111	955	18.2	12.7	87
BXRH-30E1000-B-73	3000	80	350	1587	1365	36.4	12.7	125
BXRH-30E1000-G-73	3000	80	700	1587	1365	18.2	12.7	125
BXRH-30G1000-B-73	3000	90	350	1333	1146	36.4	12.7	105
BXRH-30G1000-G-73	3000	90	700	1333	1146	18.2	12.7	105
BXRH-30G10H0-B-73	3000	90	350	1455	1251	36.4	12.7	105
BXRH-30G10H0-G-73	3000	90	700	1455	1251	18.2	12.7	105
BXRH-30G100C-B-73	3000	90	350	1222	1051	36.4	12.7	96
BXRH-30G100C-G-73	3000	90	700	1222	1051	18.2	12.7	96
BXRH-30H1000-B-73	3000	97	350	1174	1010	36.4	12.7	92
BXRH-30H1000-G-73	3000	97	700	1174	1010	18.2	12.7	92
BXRH-35A1001-B-73 ^{8,9}	3500	93	350	1333	1146	36.4	12.7	105
BXRH-35A1001-G-73 ^{8,9}	3500	93	700	1333	1146	18.2	12.7	105
BXRH-35E1000-B-73	3500	80	350	1635	1406	36.4	12.7	128
BXRH-35E1000-G-73	3500	80	700	1635	1406	18.2	12.7	128
BXRH-35G1000-B-73	3500	90	350	1365	1174	36.4	12.7	107
BXRH-35G1000-G-73	3500	90	700	1365	1174	18.2	12.7	107
BXRH-35H1000-B-73	3500	97	350	1339	1151	36.4	12.7	105
BXRH-35H1000-G-73	3500	97	700	1339	1151	18.2	12.7	105
BXRH-40E1000-B-73	4000	80	350	1650	1419	36.4	12.7	130
BXRH-40E1000-G-73	4000	80	700	1650	1419	18.2	12.7	130
BXRH-40G1000-B-73	4000	90	350	1397	1201	36.4	12.7	110
BXRH-40G1000-G-73	4000	90	700	1397	1201	18.2	12.7	110
BXRH-40H1000-B-73	4000	97	350	1374	1182	36.4	12.7	108
BXRH-40H1000-G-73	4000	97	700	1374	1182	18.2	12.7	108

Notes for Table 1:

- Nominal CCT as defined by ANSI C78.377-2011.
- CRI values are typical for Decor Series Ultra and Decor Series Class A products. CRI values are minimums for all other products. Minimum Rg value for 80 CRI products is 0, the minimum Rg values for 90 CRI products is 50, the minimum Rg values for 97 CRI products is 91. Bridgelux maintains a ± 3 tolerance on CRI and Rg values.
- Drive current is referred to as nominal drive current.
- Products tested under pulsed condition (10ms pulse width) at nominal test current where T_j (junction temperature) - T_c (case temperature) = 25°C .
- Typical performance values are provided as a reference only and are not a guarantee of performance.
- Bridgelux maintains a $\pm 7\%$ tolerance on flux measurements.
- Minimum flux values at the nominal test current are guaranteed by 100% test.
- Nominal CCT is defined by the Lighting Research Center's Class A definition. The center of the Class A color bin is on the corresponding isothermal line.
- GAI value is 80. To help ensure optimal fixture level performance, GAI is measured at the fixture level, on axis, at a case temperature of 70°C . GAI may vary depending on fixture design and performance.

Product Selection Guide

Table 2: Selection Guide, Stabilized DC Performance ($T_c = 85^\circ\text{C}$)^{4,5}

Part Number	Nominal CCT ¹ (K)	CRI ²	Nominal Drive Current ³ (mA)	Typical DC Flux ^{4,5} $T_c = 85^\circ\text{C}$ (lm)	Minimum DC Flux ⁶ $T_c = 85^\circ\text{C}$ (lm)	Typical V_f (V)	Typical Power (W)	Typical Efficacy (lm/W)
BXRH-27E1000-B-73	2700	80	350	1327	1141	35.4	12.4	107
BXRH-27E1000-G-73	2700	80	700	1327	1141	17.7	12.4	107
BXRH-27G1000-B-73	2700	90	350	1103	949	35.4	12.4	89
BXRH-27G1000-G-73	2700	90	700	1103	949	17.7	12.4	89
BXRH-27G10H0-B-7x	2700	90	350	1219	1048	35.4	12.4	98
BXRH-27G10H0-G-7x	2700	90	700	1219	1048	17.7	12.4	98
BXRH-27H1000-B-73	2700	97	350	978	841	35.4	12.4	79
BXRH-27H1000-G-73	2700	97	700	978	841	17.7	12.4	79
BXRH-30E1000-B-73	3000	80	350	1397	1201	35.4	12.4	113
BXRH-30E1000-G-73	3000	80	700	1397	1201	17.7	12.4	113
BXRH-30G1000-B-73	3000	90	350	1173	1009	35.4	12.4	95
BXRH-30G1000-G-73	3000	90	700	1173	1009	17.7	12.4	95
BXRH-30G10H0-B-73	3000	90	350	1280	1101	35.4	12.4	103
BXRH-30G10H0-G-73	3000	90	700	1280	1101	17.7	12.4	103
BXRH-30G100C-B-73	3000	90	350	1075	925	35.4	12.4	87
BXRH-30G100C-G-73	3000	90	700	1075	925	17.7	12.4	87
BXRH-30H1000-B-73	3000	97	350	1033	889	35.4	12.4	83
BXRH-30H1000-G-73	3000	97	700	1033	889	17.7	12.4	83
BXRH-35A1001-B-73 ^{8,9}	3500	93	350	1173	1009	35.4	12.4	95
BXRH-35A1001-G-73 ^{8,9}	3500	93	700	1173	1009	17.7	12.4	95
BXRH-35E1000-B-73	3500	80	350	1438	1237	35.4	12.4	116
BXRH-35E1000-G-73	3500	80	700	1438	1237	17.7	12.4	116
BXRH-35G1000-B-73	3500	90	350	1201	1033	35.4	12.4	97
BXRH-35G1000-G-73	3500	90	700	1201	1033	17.7	12.4	97
BXRH-35H1000-B-73	3500	97	350	1178	1013	35.4	12.4	95
BXRH-35H1000-G-73	3500	97	700	1178	1013	17.7	12.4	95
BXRH-40E1000-B-73	4000	80	350	1452	1249	35.4	12.4	117
BXRH-40E1000-G-73	4000	80	700	1452	1249	17.7	12.4	117
BXRH-40G1000-B-73	4000	90	350	1229	1057	35.4	12.4	99
BXRH-40G1000-G-73	4000	90	700	1229	1057	17.7	12.4	99
BXRH-40H1000-B-73	4000	97	350	1209	1040	35.4	12.4	98
BXRH-40H1000-G-73	4000	97	700	1209	1040	17.7	12.4	98

Notes for Table 2:

- Nominal CCT as defined by ANSI C78.377-2011.
- All CRI values are measured at $T_j - T_c = 25^\circ\text{C}$. CRI values are typical for Decor Series Ultra and Decor Series Class A products. CRI values are minimums for all other products. Minimum Rg value for 80 CRI products is 0, the minimum Rg values for 90 CRI products is 50, the minimum Rg values for 97 CRI products is 91. Bridgelux maintains a ± 3 tolerance on CRI and Rg values.
- Drive current is referred to as nominal drive current.
- Typical stabilized DC performance values are provided as reference only and are not a guarantee of performance.
- Typical performance is estimated based on operation under DC (direct current) with LED array mounted onto a heat sink with thermal interface material and the case temperature maintained at 85°C . Based on Bridgelux test setup, values may vary depending on the thermal design of the luminaire and/or the exposed environment to which the product is subjected.
- Minimum flux values at elevated temperatures are provided for reference only and are not guaranteed by 100% production testing. Based on Bridgelux test setup, values may vary depending on the thermal design of the luminaire and/or the exposed environment to which the product is subjected.
- Nominal CCT is defined by the Lighting Research Center's Class A definition. The center of the Class A color bin is on the corresponding isothermal line.
- GAI value is 80. To help ensure optimal fixture level performance, GAI is measured at the fixture level, on axis, at a case temperature of 70°C . GAI may vary depending on fixture design and performance.

European Product Registry for Energy Labeling

The European Product Registry for Energy Labeling (EPREL) is defined in the EU Regulation 2017/1369 to provide important energy efficiency information to consumers. Together with Energy Labeling Regulation ELR (EU) 2019/2015 which was amended by regulation (EU) 2021/340 for energy labelling of light sources, manufacturers are required to declare an energy class based on key technical specifications from each of their product and register it in an open data base managed by EPREL. It is now a legal requirement for a vendor of light sources to upload information about their products into the EPREL database before placing these products on the market in the EU.

Table 3 below provides a list of part numbers that are in compliance with ELR and are currently listed in the EPREL database.

At Bridgelux, we are fully committed to supplying products that are compliant with pertinent laws, rules, and obligation imposed by relevant government bodies including the European Energy Labeling regulation. Customers can use these

Table 3: Part numbers registered in European Product Registry for Energy Labeling

PART NUMBER ¹	CCT (K)	CRI	Current ² (mA)	Vf (V)	Useful flux ³ (Φ_{use}) at 85°C (lm)	Power (W)	Efficacy (lm/W)	Energy efficiency class ⁴ 	Registration No	URL to Product Information Sheet in EPREL Database
BXRH-27E1000-B-73	2700	80	360	36.8	1416	13.3	107	F	875781	https://eprelec.europa.eu/qr/875781
BXRH-27E1000-G-73	2700	80	740	17.9	1416	13.3	107	F	875785	https://eprelec.europa.eu/qr/875785
BXRH-27G1000-B-73	2700	90	270	36.0	926	9.7	95	F	875803	https://eprelec.europa.eu/qr/875803
BXRH-27G1000-G-73	2700	90	560	17.4	926	9.7	95	F	875807	https://eprelec.europa.eu/qr/875807
BXRH-27H1000-B-73	2700	95	220	36.2	698	8.0	88	G	875837	https://eprelec.europa.eu/qr/875837
BXRH-27H1000-G-73	2700	95	460	17.3	698	8.0	88	G	875841	https://eprelec.europa.eu/qr/875841
BXRH-30E1000-B-73	3000	80	410	36.6	1634	15.0	109	F	875867	https://eprelec.europa.eu/qr/875867
BXRH-30E1000-G-73	3000	80	830	18.1	1634	15.0	109	F	875871	https://eprelec.europa.eu/qr/875871
BXRH-30G1000-B-73	3000	90	320	35.9	1123	11.5	98	F	875899	https://eprelec.europa.eu/qr/875899
BXRH-30G1000-G-73	3000	90	650	17.7	1123	11.5	98	F	875903	https://eprelec.europa.eu/qr/875903
BXRH-30G100C-B-73	3000	90	260	34.0	836	8.8	95	F	875911	https://eprelec.europa.eu/qr/875911
BXRH-30G100C-G-73	3000	90	530	16.7	836	8.8	95	F	875915	https://eprelec.europa.eu/qr/875915
BXRH-30H1000-B-73	3000	95	250	35.4	804	8.8	91	G	875946	https://eprelec.europa.eu/qr/875946
BXRH-30H1000-G-73	3000	95	520	17.0	804	8.8	91	G	875950	https://eprelec.europa.eu/qr/875950
BXRH-35A1001-B-73	3500	90	320	35.9	1123	11.5	98	F	875969	https://eprelec.europa.eu/qr/875969
BXRH-35A1001-G-73	3500	90	650	17.7	1123	11.5	98	F	875971	https://eprelec.europa.eu/qr/875971
BXRH-35G1000-B-73	3500	90	330	34.8	1150	11.5	100	F	876004	https://eprelec.europa.eu/qr/876004
BXRH-35G1000-G-73	3500	90	680	16.9	1150	11.5	100	F	876008	https://eprelec.europa.eu/qr/876008
BXRH-40E1000-B-73	4000	80	450	37.3	1837	16.8	109	F	876046	https://eprelec.europa.eu/qr/876046
BXRH-40E1000-G-73	4000	80	910	18.5	1837	16.8	109	F	876050	https://eprelec.europa.eu/qr/876050
BXRH-40G1000-B-73	4000	90	350	35.4	1245	12.4	101	F	876068	https://eprelec.europa.eu/qr/876068
BXRH-40G1000-G-73	4000	90	720	17.2	1245	12.4	101	F	876072	https://eprelec.europa.eu/qr/876072

Notes for Table 3:

- All device listed here must be disposed as e-waste upon its end of life according to local country guideline in each country.
- For information on performance values at alternative drive conditions, please refer to the Product Selection Guide, Absolute Maximum Rating Table and Performance Curves in this data sheet.
- For a definition of useful luminous flux (Φ_{use}), please see the ELR regulations at <https://tinyurl.com/4b6zvt4m>.
- EPREL requires an arrow symbol containing the letter of the energy efficiency class to be displayed, on technical promotional material. Refer to this energy efficiency class column for specific energy efficiency class on each part number.

Performance at Commonly Used Drive Currents

V Series HD LED arrays are tested to the specifications shown using the nominal drive currents in Table 1. V Series HD LED arrays may also be driven at other drive currents dependent on specific application design requirements. The performance at any drive current can be derived from the current vs. voltage characteristics shown in Figure 1 & 2 and the flux vs. current characteristics shown in Figure 3 & 4. The performance at commonly used drive currents is summarized in Table 4.

Table 4: Product Performance at Commonly Used Drive Currents

Part Number	CRI	Drive Current ¹ (mA)	Typical V_f $T_c = 25^\circ\text{C}$ (V)	Typical Power $T_c = 25^\circ\text{C}$ (W)	Typical Flux ² $T_c = 25^\circ\text{C}$ (lm)	Typical DC Flux ³ $T_c = 85^\circ\text{C}$ (lm)	Typical Efficacy $T_c = 25^\circ\text{C}$ (lm/W)
BXRH-27E1000-B-73	80	175	34.2	6.0	813	715	136
		250	35.2	8.8	1123	988	128
		350	36.4	12.7	1508	1327	118
		440	37.3	16.4	1833	1613	112
		480	37.7	18.1	1970	1734	109
BXRH-27E1000-G-73	80	350	16.9	5.9	813	715	137
		500	17.4	8.7	1123	988	129
		700	18.2	12.7	1508	1327	118
		880	18.5	16.3	1833	1613	113
		960	18.7	17.9	1970	1734	110
BXRH-27G1000-B-73	90	175	34.2	6.0	676	595	113
		250	35.2	8.8	934	822	106
		350	36.4	12.7	1254	1103	98
		440	37.3	16.4	1524	1341	93
		480	37.7	18.1	1638	1442	90
BXRH-27G1000-G-73	90	350	16.9	5.9	676	595	114
		500	17.4	8.7	934	822	107
		700	18.2	12.7	1254	1103	98
		880	18.5	16.3	1524	1341	94
		960	18.7	17.9	1638	1442	91
BXRH-27G10H0-B-73	90	175	34.2	6.0	747	672	125
		250	35.2	8.8	1030	927	117
		350	36.4	12.7	1385	1246	109
		440	37.3	16.4	1684	1516	103
		480	37.7	18.1	1810	1629	100
BXRH-27G10H0-G-73	90	350	16.9	5.9	747	672	126
		500	17.4	8.7	1030	927	118
		700	18.2	12.7	1385	1246	109
		880	18.5	16.3	1684	1516	103
		960	18.7	18.0	1810	1629	101
BXRH-27H1000-B-73	97 (typical)	175	34.2	6.0	599	527	100
		250	35.2	8.8	827	728	94
		350	36.4	12.7	1111	978	87
		440	37.3	16.4	1351	1189	82
		480	37.7	18.1	1452	1277	80
BXRH-27H1000-G-73	97 (typical)	350	16.9	5.9	599	527	101
		500	17.4	8.7	827	728	95
		700	18.2	12.7	1111	978	87
		880	18.5	16.3	1351	1189	83
		960	18.7	17.9	1452	1277	81

Notes for Table 4:

1. Alternate drive currents are provided for reference only and are not a guarantee of performance.
2. Bridgelux maintains a $\pm 7\%$ tolerance on flux measurements.
3. Typical stabilized DC performance values are provided as reference only and are not a guarantee of performance.

Performance at Commonly Used Drive Currents

Table 4: Product Performance at Commonly Used Drive Currents (Continued)

Part Number	CRI	Drive Current ¹ (mA)	Typical V _f T _c = 25°C (V)	Typical Power T _c = 25°C (W)	Typical Flux ² T _c = 25°C (lm)	Typical DC Flux ³ T _c = 85°C (lm)	Typical Efficacy T _c = 25°C (lm/W)
BXRH-30E1000-B-73	80	175	34.2	6.0	855	753	143
		250	35.2	8.8	1182	1040	134
		350	36.4	12.7	1587	1397	125
		440	37.3	16.4	1930	1698	117
		480	37.7	18.1	2074	1825	114
BXRH-30E1000-G-73	80	350	16.9	5.9	855	753	144
		500	17.4	8.7	1182	1040	136
		700	18.2	12.7	1587	1397	125
		880	18.5	16.3	1930	1698	119
		960	18.7	17.9	2074	1825	116
BXRH-30G1000-B-73	90	175	34.2	6.0	718	632	120
		250	35.2	8.8	993	874	113
		350	36.4	12.7	1333	1173	105
		440	37.3	16.4	1621	1426	99
		480	37.7	18.1	1742	1533	96
BXRH-30G1000-G-73	90	350	16.9	5.9	718	632	121
		500	17.4	8.7	993	874	114
		700	18.2	12.7	1333	1173	105
		880	18.5	16.3	1621	1426	100
		960	18.7	17.9	1742	1533	97
BXRH-30G10H0-B-73	90	175	34.2	6.0	784	706	131
		250	35.2	8.8	1082	974	123
		350	36.4	12.7	1455	1309	114
		440	37.3	16.4	1769	1592	108
		480	37.7	18.1	1901	1711	105
BXRH-30G10H0-G-73	90	350	16.9	5.9	784	706	133
		500	17.4	8.7	1082	974	124
		700	18.2	12.7	1455	1309	114
		880	18.5	16.3	1769	1592	109
		960	18.7	18.0	1901	1711	106
BXRH-30G100C-B-73	90	175	34.2	6.0	659	580	110
		250	35.2	8.8	910	801	103
		350	36.4	12.7	1222	1075	96
		440	37.3	16.4	1486	1308	90
		480	37.7	18.1	1597	1405	88
BXRH-30G100C-G-73	90	350	16.9	5.9	659	580	111
		500	17.4	8.7	910	801	105
		700	18.2	12.7	1222	1075	96
		880	18.5	16.3	1486	1308	91
		960	18.7	17.9	1597	1405	89
BXRH-30H1000-B-73	97 (typcal)	175	34.2	6.0	633	557	106
		250	35.2	8.8	874	770	99
		350	36.4	12.7	1174	1033	92
		440	37.3	16.4	1428	1257	87
		480	37.7	18.1	1535	1350	85

Notes for Table 4:

1. Alternate drive currents are provided for reference only and are not a guarantee of performance.
2. Bridgelux maintains a ± 7% tolerance on flux measurements.
3. Typical stabilized DC performance values are provided as reference only and are not a guarantee of performance.

Performance at Commonly Used Drive Currents

Table 4: Product Performance at Commonly Used Drive Currents (Continued)

Part Number	CRI	Drive Current ¹ (mA)	Typical V_f $T_c = 25^\circ\text{C}$ (V)	Typical Power $T_c = 25^\circ\text{C}$ (W)	Typical Flux ² $T_c = 25^\circ\text{C}$ (lm)	Typical DC Flux ³ $T_c = 85^\circ\text{C}$ (lm)	Typical Efficacy $T_c = 25^\circ\text{C}$ (lm/W)
BXRH-30H1000-G-73	97 (typcal)	350	16.9	5.9	633	557	107
		500	17.4	8.7	874	770	100
		700	18.2	12.7	1174	1033	92
		880	18.5	16.3	1428	1257	88
BXRH-35A1001-B-73	93 (typcal)	960	18.7	17.9	1535	1350	86
		175	34.2	6.0	718	632	120
		250	35.2	8.8	993	874	113
		350	36.4	12.7	1333	1173	105
BXRH-35A1001-G-73	93 (typcal)	440	37.3	16.4	1621	1426	99
		480	37.7	18.1	1742	1533	96
		350	16.9	5.9	718	632	121
		500	17.4	8.7	993	874	114
BXRH-35E1000-B-73	80	700	18.2	12.7	1333	1173	105
		880	18.5	16.3	1621	1426	100
		960	18.7	17.9	1742	1533	97
		175	34.2	6.0	881	775	147
BXRH-35E1000-G-73	80	250	35.2	8.8	1217	1071	138
		350	36.4	12.7	1635	1438	128
		440	37.3	16.4	1988	1749	121
		480	37.7	18.1	2136	1880	118
BXRH-35G1000-B-73	90	350	17.1	6.0	881	775	147
		500	17.6	8.8	1217	1071	138
		700	18.2	12.7	1635	1438	128
		880	18.7	16.4	1988	1749	121
BXRH-35G1000-G-73	90	960	18.9	18.1	2136	1880	118
		175	34.2	5.9	736	647	123
		250	35.2	8.8	1016	894	116
		350	36.4	12.7	1365	1201	107
BXRH-35H1000-B-73	97 (typcal)	440	37.3	16.4	1659	1460	101
		480	37.7	18.1	1783	1569	98
		350	16.9	6.0	736	647	124
		500	17.4	8.7	1016	894	117
BXRH-35H1000-G-73	97 (typcal)	700	18.2	12.7	1365	1201	107
		880	18.5	16.3	1659	1460	102
		960	18.7	17.9	1783	1569	99
		175	34.2	6.0	722	650	121
BXRH-35H1000-G-73	97 (typcal)	250	35.2	8.8	996	896	113
		350	36.4	12.7	1339	1205	105
		440	37.3	16.4	1628	1465	99
		480	37.7	18.1	1750	1575	97
BXRH-35H1000-G-73	97 (typcal)	350	16.9	5.9	722	650	122
		500	17.4	8.7	996	896	114
		700	18.2	12.7	1339	1205	105
		880	18.5	16.3	1628	1465	100
BXRH-35H1000-G-73	97 (typcal)	960	18.7	18.0	1750	1575	97

Notes for Table 4:

1. Alternate drive currents are provided for reference only and are not a guarantee of performance.
2. Bridgelux maintains a $\pm 7\%$ tolerance on flux measurements.
3. Typical stabilized DC performance values are provided as reference only and are not a guarantee of performance.

Performance at Commonly Used Drive Currents

Table 4: Product Performance at Commonly Used Drive Currents (Continued)

Part Number	CRI	Drive Current ¹ (mA)	Typical V_f $T_c = 25^\circ\text{C}$ (V)	Typical Power $T_c = 25^\circ\text{C}$ (W)	Typical Flux ² $T_c = 25^\circ\text{C}$ (lm)	Typical DC Flux ³ $T_c = 85^\circ\text{C}$ (lm)	Typical Efficacy $T_c = 25^\circ\text{C}$ (lm/W)
BXRH-40E1000-B-73	80	175	34.2	6.0	889	783	149
		250	35.2	8.8	1229	1082	140
		350	36.4	12.7	1650	1452	130
		440	37.3	16.4	2007	1766	122
		480	37.7	18.1	2157	1898	119
BXRH-40E1000-G-73	80	350	16.9	5.9	889	783	150
		500	17.4	8.7	1229	1082	141
		700	18.2	12.7	1650	1452	130
		880	18.5	16.3	2007	1766	123
		960	18.7	17.9	2157	1898	120
BXRH-40G1000-B-73	90	175	34.2	6.0	753	662	126
		250	35.2	8.8	1040	915	118
		350	36.4	12.7	1397	1229	110
		440	37.3	16.4	1698	1494	103
		480	37.7	18.1	1825	1606	101
BXRH-40G1000-G-73	90	350	16.9	5.9	753	662	127
		500	17.4	8.7	1040	915	119
		700	18.2	12.7	1397	1229	110
		880	18.5	16.3	1698	1494	104
		960	18.7	17.9	1825	1606	102
BXRH-40H1000-B-73	97	175	34.2	6.0	741	667	124
		250	35.2	8.8	1022	920	116
		350	36.4	12.7	1374	1237	108
		440	37.3	16.4	1671	1504	102
		480	37.7	18.1	1796	1616	99
BXRH-40H1000-G-73	97	350	16.9	5.9	741	667	125
		500	17.4	8.7	1022	920	117
		700	18.2	12.7	1374	1237	108
		880	18.5	16.3	1671	1504	103
		960	18.7	18.0	1796	1616	100

Notes for Table 4:

1. Alternate drive currents are provided for reference only and are not a guarantee of performance.
2. Bridgelux maintains a $\pm 7\%$ tolerance on flux measurements.
3. Typical stabilized DC performance values are provided as reference only and are not a guarantee of performance.

Electrical Characteristics

Table 5: Electrical Characteristics

Part Number	Drive Current (mA)	Forward Voltage Pulsed, $T_c = 25^\circ\text{C}$ (V) ^{1, 2, 3, 8}			Typical Coefficient of Forward Voltage ⁴ $\Delta V_f / \Delta T_c$ (mV/ $^\circ\text{C}$)	Typical Thermal Resistance Junction to Case ^{5,6} R_{j-c} ($^\circ\text{C}/\text{W}$)	Driver Selection Voltages ⁷ (V)	
		Minimum	Typical	Maximum			V_f Min. Hot $T_c = 105^\circ\text{C}$ (V)	V_f Max. Cold $T_c = -40^\circ\text{C}$ (V)
BXRH-xxx100x-B-73	350	34.1	36.4	39.1	-16.2	0.36	32.8	40.2
	480	35.2	37.7	40.4	-16.2	0.39	33.9	41.5
BXRH-xxx100x-G-73	700	17.0	18.2	19.6	-8.1	0.36	16.4	20.1
	960	17.6	18.7	20.2	-8.1	0.39	16.9	20.8

Notes for Table 5:

- Parts are tested in pulsed conditions. $T_c = 25^\circ\text{C}$. Pulse width is 10ms.
- Voltage minimum and maximum are provided for reference only and are not a guarantee of performance.
- Bridgelux maintains a tester tolerance of $\pm 0.10\text{V}$ on forward voltage measurements.
- Typical coefficient of forward voltage tolerance is $\pm 0.1\text{mV}$ for nominal current.
- Thermal resistance values are based from test data of a 3000K 80 CRI product.
- Thermal resistance value was calculated using total electrical input power; optical power was not subtracted from input power. The thermal interface material used during testing is not included in the thermal resistance value.
- V_f min hot and max cold values are provided as reference only and are not guaranteed by test. These values are provided to aid in driver design and selection over the operating range of the product.
- This product has been designed and manufactured per IEC 62031:2018. This product has passed dielectric withstand voltage testing at 500 V. The working voltage designated for the insulation is 50V d.c. The maximum allowable voltage across the array must be determined in the end product application.

Eye Safety

Table 6: Eye Safety Risk Group (RG) Classifications

Part Number	Drive Current ³ (mA)	CCT ^{1,3}	
		2700K/3000K	4000K ²
BXRH-xxx100x-B-73	350	RG1	RG2
	480	RG1	RG2
BXRH-xxx100x-G-73	700	RG1	RG2
	960	RG1	RG2

Notes for Table 6:

1. Eye safety classification for the use of Bridgelux V Series HD LED arrays is in accordance with specification IEC/TR 62778: Application of IEC 62471 for the assessment of blue light hazard to light sources and luminaires.
2. For products classified as RG2 at 4000K, E_{thr} = 1760 lx.
3. Please contact your Bridgelux sales representative for E_{thr} values at specific drive currents and CCTs not listed.

Absolute Maximum Ratings

Table 7: Maximum Ratings

Parameter	Maximum Rating	
LED Junction Temperature (T _J)	125°C	
Storage Temperature	-40°C to +105°C	
Operating Case Temperature ¹ (T _C)	105°C	
Soldering Temperature ²	300°C or lower for a maximum of 6 seconds	
	BXRH-xxx100x-B-73	BXRH-xxx100x-G-73
Maximum Drive Current ³	480mA	960mA
Maximum Peak Pulsed Drive Current ⁴	680mA	1360mA
Maximum Reverse Voltage ⁵	-60V	-35V

Notes for Table 7:

1. For IEC 62717 requirement, please consult your Bridgelux sales representative.
2. Refer to Bridgelux Application Note AN101: Handling and Assembly of Bridgelux V Series LED Arrays.
3. Arrays may be driven at higher currents however lumen maintenance may be reduced, and product warranty will be void.
4. Bridgelux recommends a maximum duty cycle of 10% and pulse width of 20 ms when operating LED Arrays at maximum peak pulsed current specified. Maximum peak pulsed currents indicate values where LED Arrays can be driven without catastrophic failures.
5. Light emitting diodes are not designed to be driven in reverse voltage and will not produce light under this condition. Maximum rating provided for reference only.

Performance Curves

Figure 1: Drive Current vs. Voltage V6B HD²

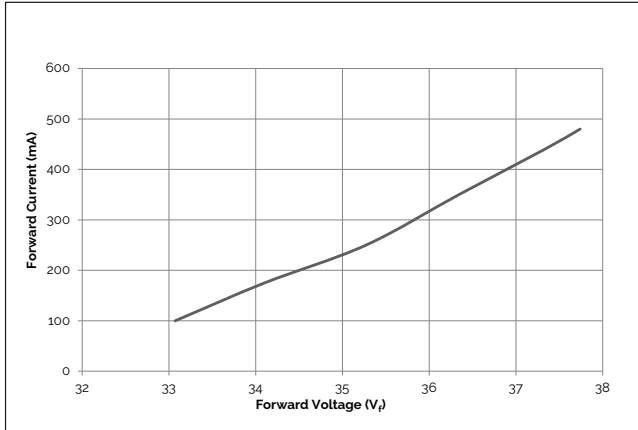

Figure 2: Drive Current vs. Voltage V6G HD²

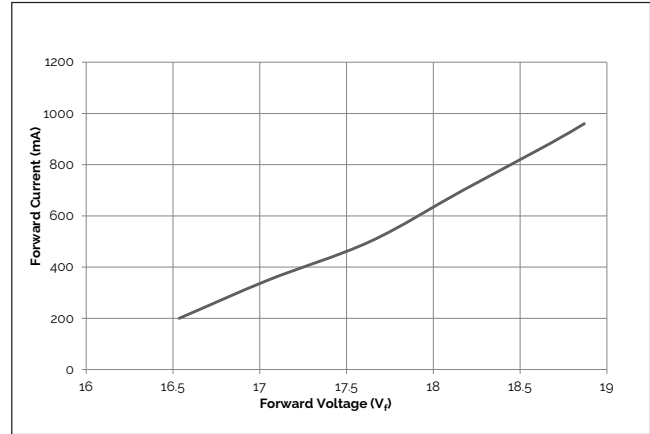

Figure 3: Typical Relative Flux vs. Current V6B HD^{1,2}

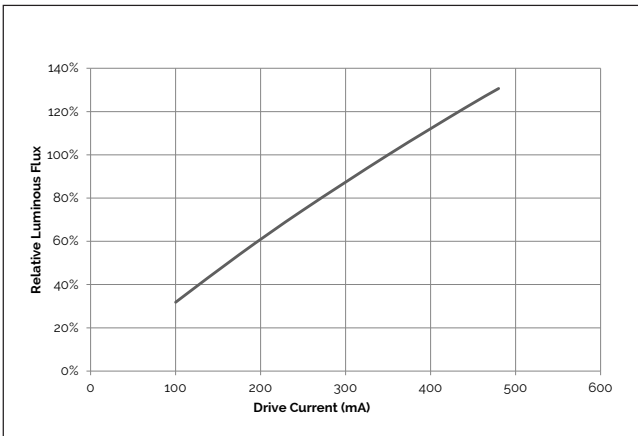

Figure 4: Typical Relative Flux vs. Current V6G HD^{1,2}

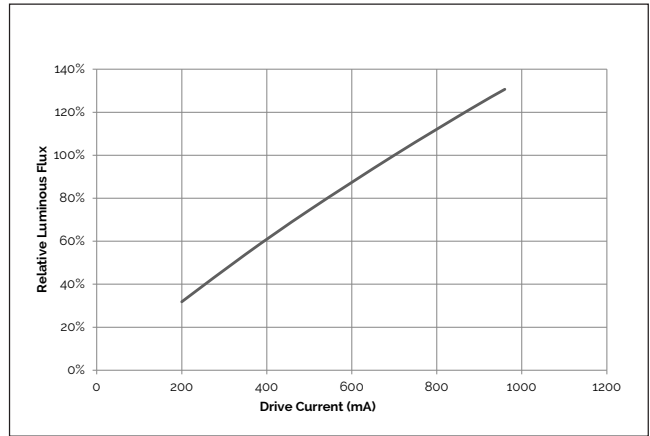
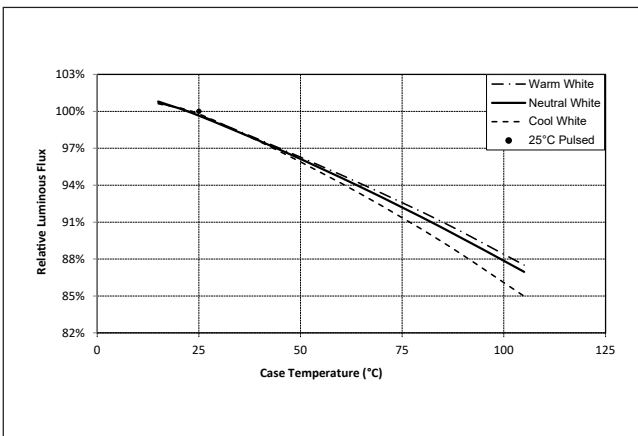

Figure 5: Typical DC Flux vs. Case Temperature³



Notes for Figures 1-5:

1. Bridgelux does not recommend driving high power LEDs at low currents. Doing so may produce unpredictable results. Pulse width modulation (PWM) is recommended for dimming effects.
2. Products tested under pulsed condition (10ms pulse width) at nominal test current where T_j (junction temperature) = T_c (case temperature) = 25°C.
3. Characteristics shown for warm white based on 3000K and 80 CRI. Characteristics shown for neutral white based on 4000K and 80 CRI. Characteristics shown for warm white includes Decor Series Class A

Performance Curves

Figure 6: Typical DC ccx Shift vs. Case Temperature⁴

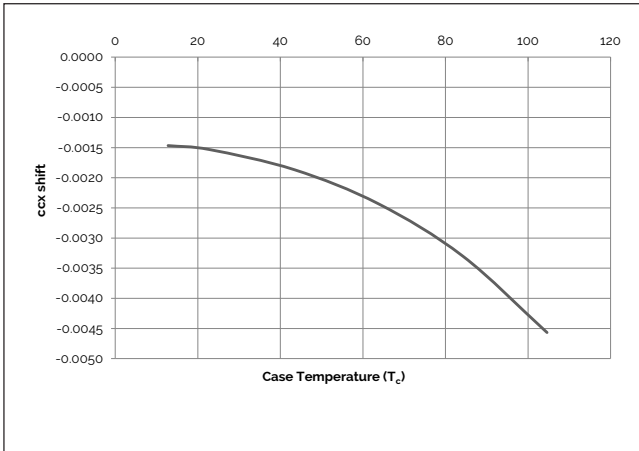

Figure 7: Typical DC ccy Shift vs. Case Temperature⁴

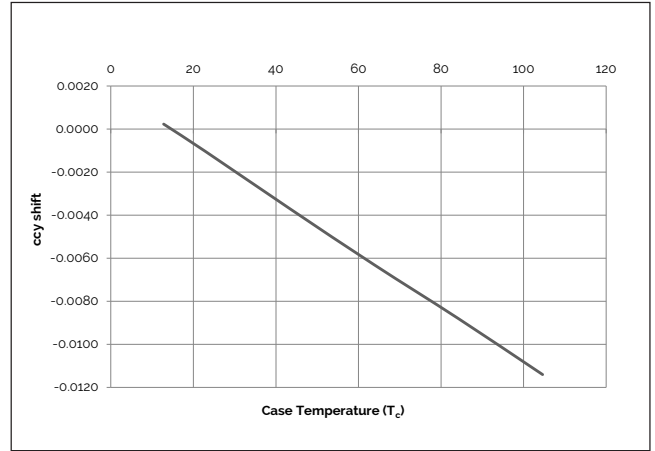

Figure 8: 2700K, 97 CRI Color Shift vs. Case Temperature¹

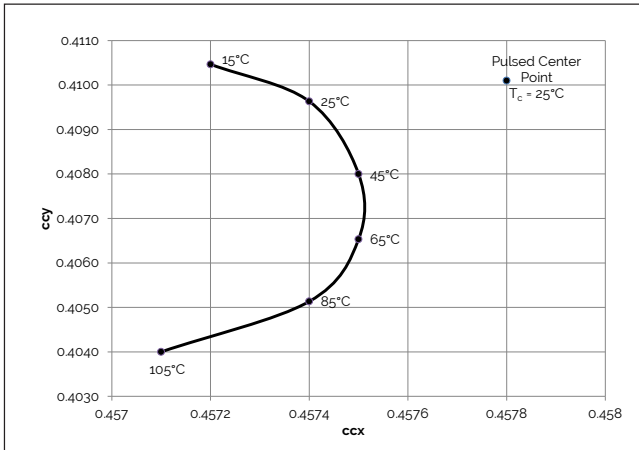

Figure 9: 3000K, 97 CRI Color Shift vs. Case Temperature¹

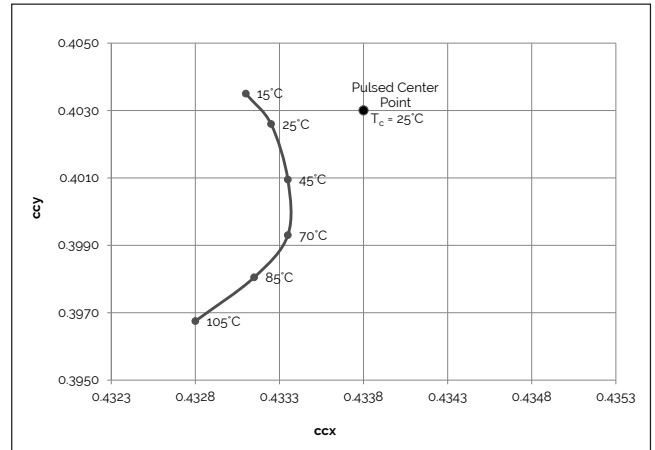

Figure 10: 3500K Class A Color Shift vs. Case Temperature¹

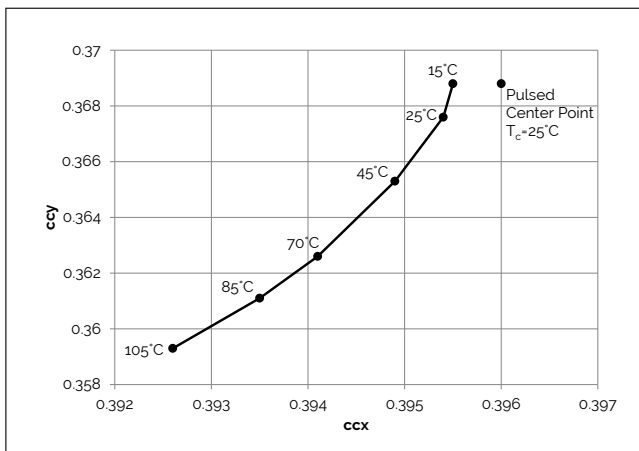
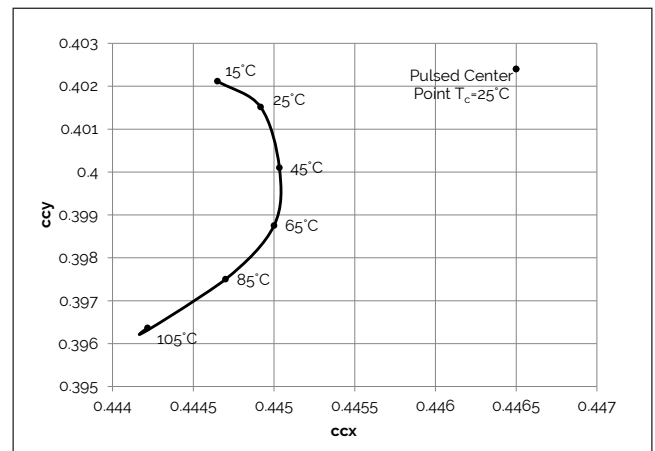

Figure 11: 3000K, 90 CRI Color Shift vs. Case Temperature³



Notes for Figures 6-11:

1. Measurements made under DC test conditions at the nominal drive current.
2. Typical color shift is shown with a tolerance of ±0.002.
3. Characteristics shown for Decor Series Showcase products. BXRH-30G100C-x-73
4. For other color SKUs, the shift in color will vary. Please contact your Bridgelux Sales Representative for more information.

Typical Radiation Pattern

Figure 12: Typical Spatial Radiation Pattern

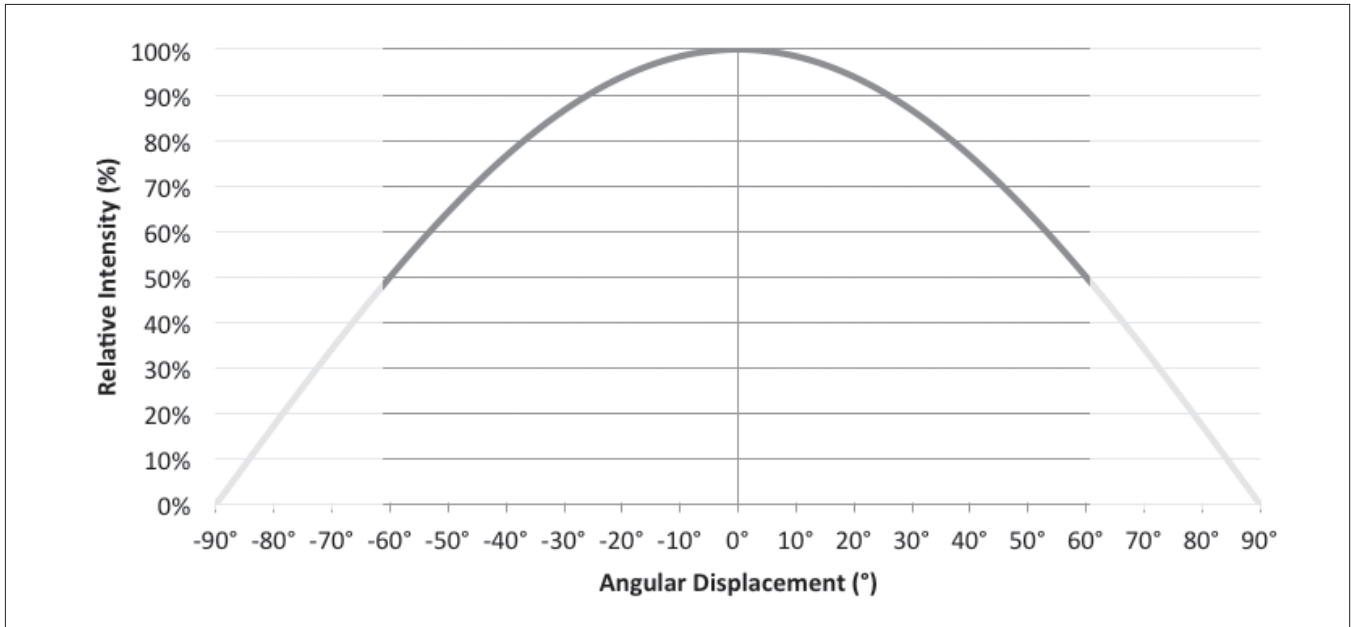

Notes for Figure 12:

1. Typical viewing angle is 120°.
2. The viewing angle is defined as the off axis angle from the centerline where intensity is ½ of the peak value.

Figure 13: Typical Polar Radiation Pattern

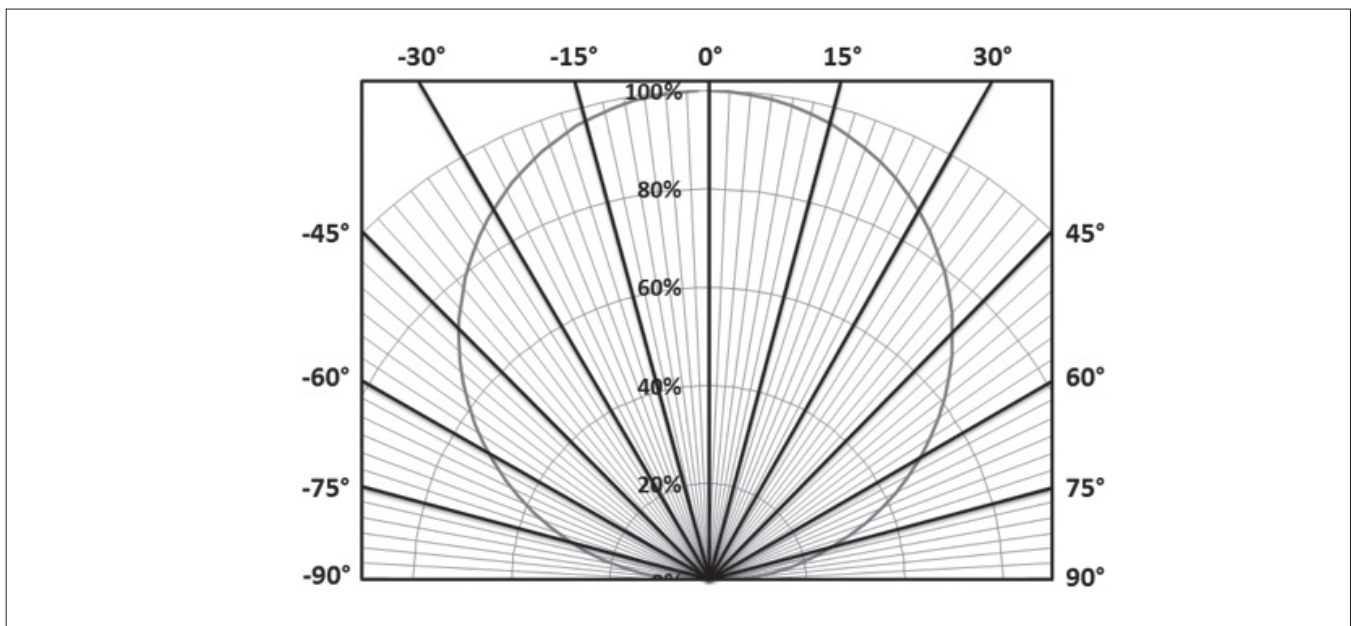

Typical Color Spectrum

Figure 14: Typical Color Spectrum

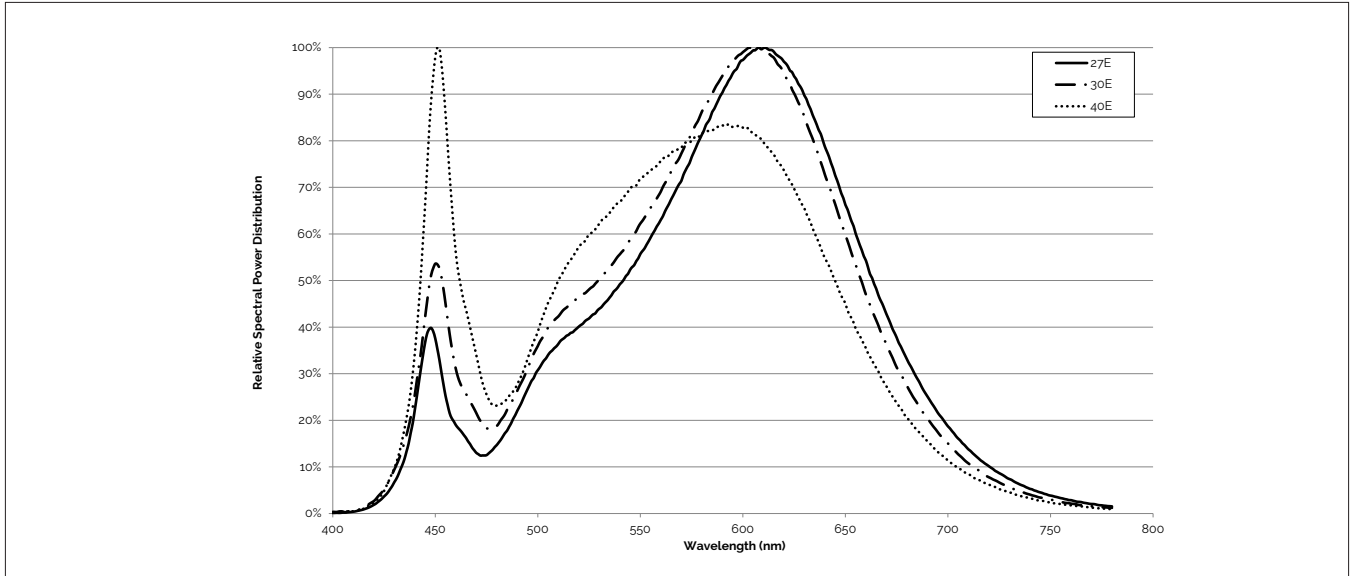

Notes for Figure 14:

1. Color spectra measured at nominal current for $T_j = T_c = 25^\circ\text{C}$.
2. Color spectra shown is 2700K and 80 CRI.
3. Color spectra shown is 3000K and 80 CRI.
4. Color spectra shown is 4000K and 80 CRI.

Figure 15: Typical Color Spectrum for Décor Series

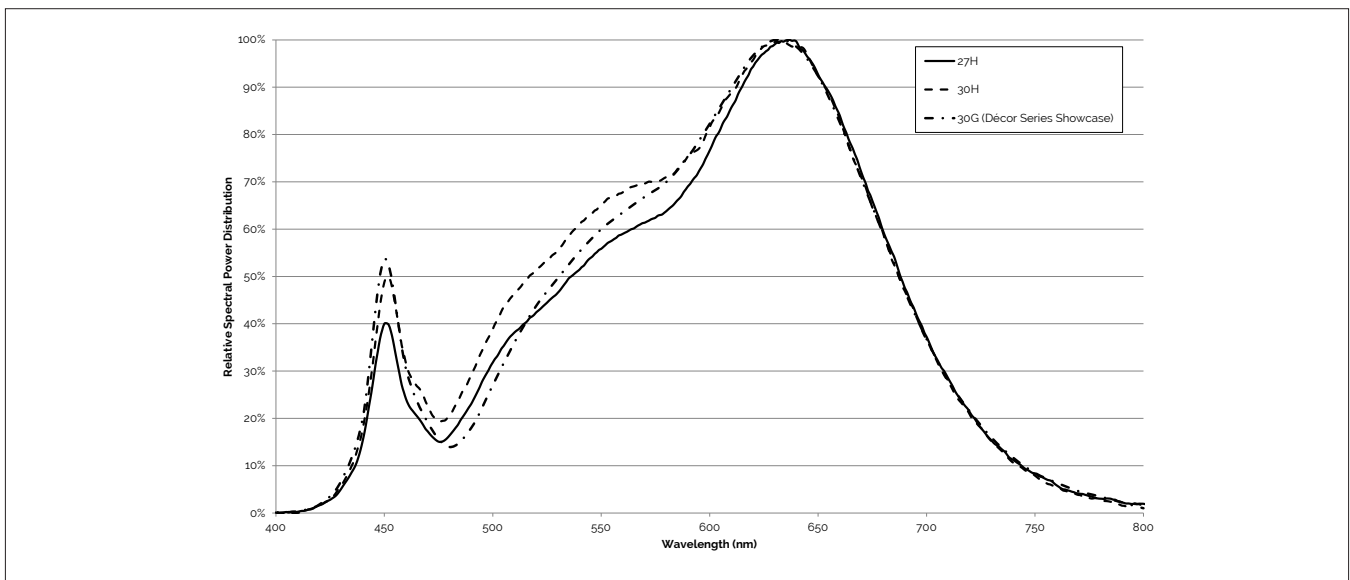

Note for Figure 15:

1. Color spectra measured at nominal current for $T_j = T_c = 25^\circ\text{C}$.

Mechanical Dimensions

Figure 16: Drawing for V6 HD LED Array

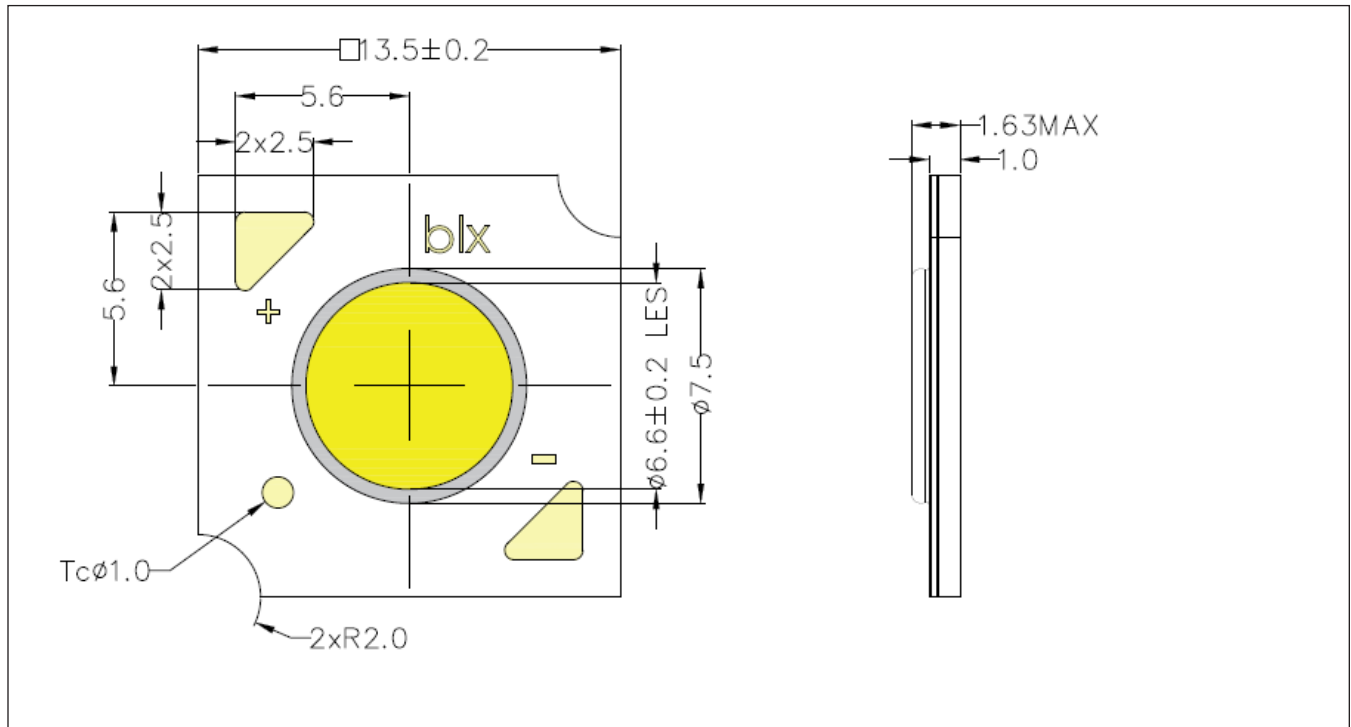

Notes for Figure 16:

1. Drawings are not to scale.
2. Drawing dimensions are in millimeters.
3. Unless otherwise specified, tolerances are ± 0.1 mm.
4. Solder pad labeled "+" denotes positive contact.
5. Refer to Application Notes AN101 for product handling, mounting and heat sink recommendations.
6. The optical center of the LED Array is nominally defined by the mechanical center of the array to a tolerance of ± 0.2 mm.
7. Bridgelux maintains a flatness of 0.10mm across the mounting surface of the array.

Color Binning Information

Figure 17: Warm and Neutral White Test Bins in xy Color Space

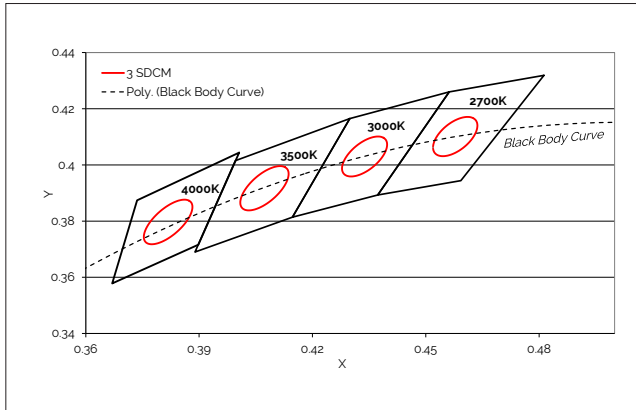

Note: Pulsed Test Conditions, $T_c = 25^\circ\text{C}$

Table 8: Warm and Neutral White xy Bin Coordinates and Associated Typical CCT

Bin Code	2700K	3000K ¹	3500K ¹	4000K ¹
ANSI Bin (for reference only)	(2580K - 2870K)	(2870K - 3220K)	(3220K - 3710K)	(3710K - 4260K)
73 (3 SDCM)	(2651K - 2794K)	(2968K - 3136K)	(3369K - 3586K)	(3851K - 4130K)
Center Point (x,y)	(0.4578, 0.4101)	(0.4338, 0.403) (0.4465, 0.4024) ²	(0.4073, 0.3917)	(0.3818, 0.3797)

Notes for Table 8:

1. Color Binning information excludes Décor Series Class A products. Please contact your Bridgelux Sales Representative for more information.
2. Center Point for Decor Series Showcase.
3. Bridgelux maintains a tolerance of +/- 0.007 on x and y color coordinates in the CIE 1931 color Space.

Packaging and Labeling

Figure 18: V6 HD Packaging Tube

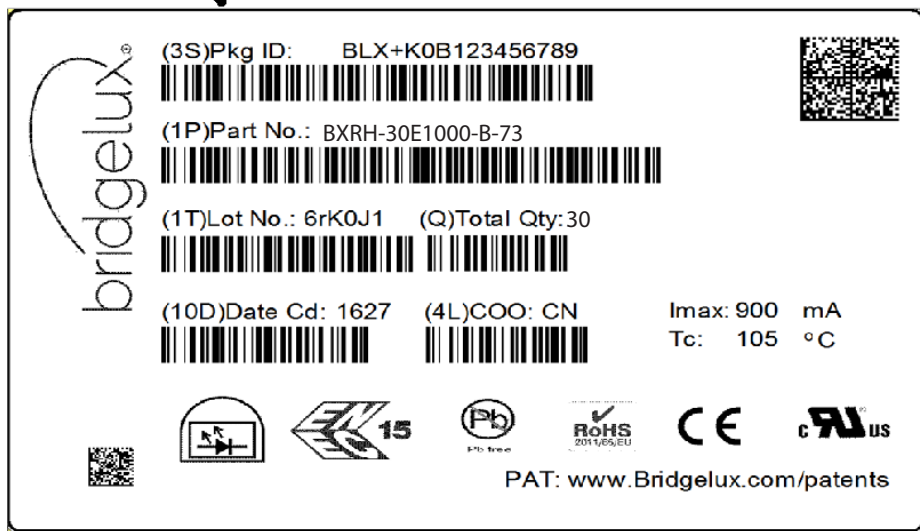

Box Label

Commercial Invoice
and Packing list



Notes for Figure 18:

1. Each tube holds 35 V6 HD COB arrays.
2. One tube is sealed in an anti-static bag. Four bags are placed in a shipping box. Depending on quantities ordered, a bigger shipping box, containing four boxes may be used to ship products.
3. Each bag and box is to be labeled as shown above.
4. Dimensions for each tube are 15.4 (W) x 8.3 (H) x 430 (L) mm. Dimensions for the anti-static bag are 75 (W) x 615 (L) x 0.075 (T) mm. Dimensions for the shipping box are 58.7 x 13.3 x 7.9 cm

Packaging and Labeling

Figure 19: V Series HD Product Labeling

Bridgelux COB arrays have laser markings on the back side of the substrate to help with product identification. In addition to the product identification markings, Bridgelux COB arrays also contain markings for internal Bridgelux manufacturing use only. The image below shows which markings are for customer use and which ones are for Bridgelux internal use only. The Bridgelux internal manufacturing markings are subject to change without notice, however these will not impact the form, function or performance of the COB array.

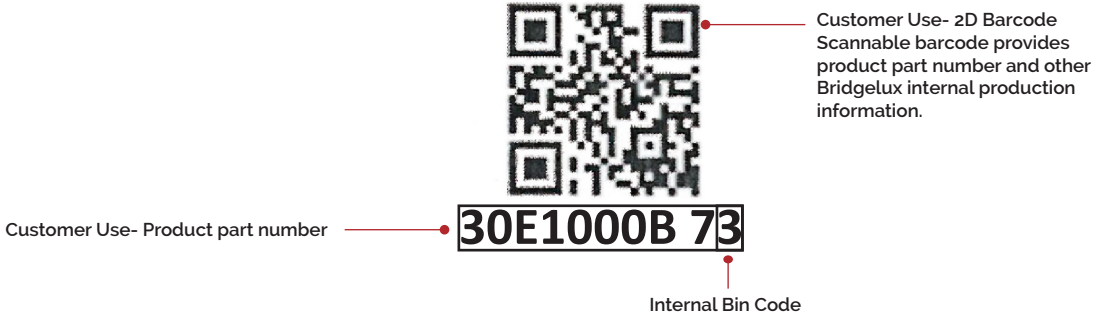

Design Resources

Application Notes

Bridgelux has developed a comprehensive set of application notes and design resources to assist customers in successfully designing with the V Series HD product family of LED array products. For all available application notes visit www.bridgelux.com.

Optical Source Models

Optical source models and ray set files are available for all Bridgelux products. For a list of available formats, visit www.bridgelux.com.

3D CAD Models

Three dimensional CAD models depicting the product outline of all Bridgelux V Series HD LED arrays are available in both IGS and STEP formats. Please contact your Bridgelux sales representative for assistance.

LM80

LM80 testing has been completed and the LM80 report is now available. Please contact your Bridgelux sales representative for LM-80 report.

Precautions

CAUTION: CHEMICAL EXPOSURE HAZARD

Exposure to some chemicals commonly used in luminaire manufacturing and assembly can cause damage to the LED array. Please consult Bridgelux Application Note AN101 for additional information.

CAUTION: RISK OF BURN

Do not touch the V Series HD LED array during operation. Allow the array to cool for a sufficient period of time before handling. The V Series HD LED array may reach elevated temperatures such that could burn skin when touched.

CAUTION

CONTACT WITH LIGHT EMITTING SURFACE (LES)

Avoid any contact with the LES. Do not touch the LES of the LED array or apply stress to the LES (yellow phosphor resin area). Contact may cause damage to the LED array.

Optics and reflectors must not be mounted in contact with the LES (yellow phosphor resin area).

Disclaimers

MINOR PRODUCT CHANGE POLICY

The rigorous qualification testing on products offered by Bridgelux provides performance assurance. Slight cosmetic changes that do not affect form, fit, or function may occur as Bridgelux continues product optimization.

STANDARD TEST CONDITIONS

Unless otherwise stated, array testing is performed at the nominal drive current.

About Bridgelux: Bridging Light and Life™

At Bridgelux, we help companies, industries and people experience the power and possibility of light. Since 2002, we've designed LED solutions that are high performing, energy efficient, cost effective and easy to integrate. Our focus is on light's impact on human behavior, delivering products that create better environments, experiences and returns—both experiential and financial. And our patented technology drives new platforms for commercial and industrial luminaires.

For more information about the company, please visit
bridgelux.com
twitter.com/Bridgelux
facebook.com/Bridgelux
youtube.com/user/Bridgelux
linkedin.com/company/bridgelux-inc-_2
WeChat ID: BridgeluxInChina



46410 Fremont Boulevard
Fremont, CA 94538 U.S.A.
Tel (925) 583-8400
www.bridgelux.com

© 2021 Bridgelux, Inc. All rights reserved 2020. Product specifications are subject to change without notice. Bridgelux, the Bridgelux stylized logo design and Vero are registered trademarks. V Series and Decor Series are trademarks of Bridgelux, Inc. All other trademarks are the property of their respective owners.

Bridgelux V6 HD Array Series Product Data Sheet DS401 Rev. J (08/2021)