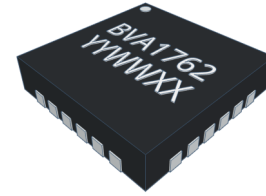


### Device Features

- Integrate DSA to AMP Functionality
- 500-8000MHz Broadband Performance
- Wide VDD Range  
AMP : 4.0V to 5.25V  
DSA : 2.7V to 5.5V
- Low current : 110mA @ 5V, 55mA @ 4V
- High Gain  
20.4dB @ 1.9GHz, 19.7dB @ 3.5GHz (VDD=5V)  
19.5dB @ 1.9GHz, 19.1dB @ 3.5GHz (VDD=4V)
- High OP1dB  
20.8dBm @ 1.9GHz, 20.7dBm @ 3.5GHz (VDD=5V)  
19.2dBm @ 1.9GHz, 19.1dBm @ 3.5GHz (VDD=4V)
- High OIP3  
36.0dBm @ 1.9GHz, 34.9dBm @ 3.5GHz (VDD=5V)  
32.5dBm @ 1.9GHz, 32.9dBm @ 3.5GHz (VDD=4V)
- Noise Figure at max gain setting  
2.6dB @ 1.9GHz, 3.2dB @ 3.5GHz
- Attenuation Range : Up to 31.75dB / 0.25dB Step
- Safe attenuation state transitions
- Excellent attenuation accuracy  
 $\pm(0.25 + 3\% \times \text{ATT})$  @ 1.9 GHz  
 $\pm(0.25 + 5\% \times \text{ATT})$  @ 3.5 GHz
- Programming modes  
Serial mode only to minimize Control line
- 3bit Addressable function  
LE/DATA/CLK can be shared up to 8EA Chips
- Lead-free/RoHS2-compliant 24-lead 4mm x 4mm x 0.9mm QFN SMT package



24-lead 4mm x 4mm x 0.9mm QFN

Figure 1. Package Type

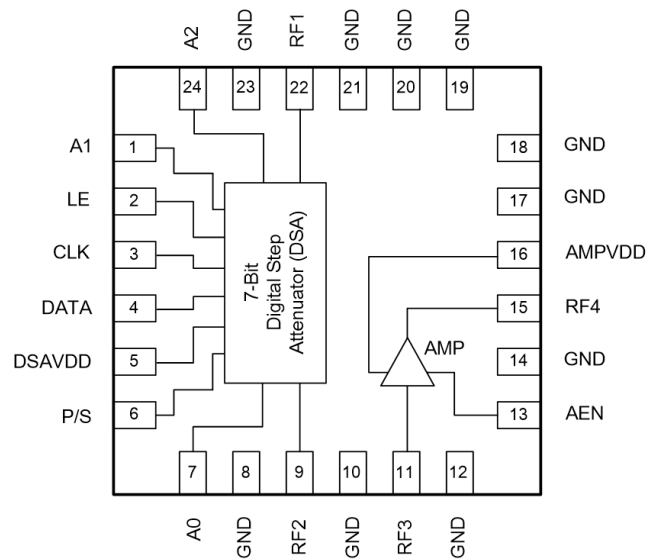


Figure 2. Functional Block Diagram

### Product Description

The BVA1762 is a high performance, digitally controlled variable gain amplifier (DVGA) operating from 500MHz to 8GHz.

The BVA1762 integrates a high performance digital step attenuator (DSA) and a high linearity, broadband gain block amplifier operating voltage 4.0V to 5.25V DC within enable control using the small package (4x4mm QFN package).

Both DSA and gain block amplifier in BVA1762 are internally matched to 50 Ohms and It is easy to use with minimum external matching components required.

The BVA1762 can control 7bit attenuation to 0.25dB step up to 31.75dB and initialize to the maximum attenuation setting on power-up until next programming word is inputted. In addition, Internal DSA has a 3-bit addressable function, so it can share up to 8 DSA's Latch Enable(LE), DATA and CLOCK(CLK) pin. This has the advantage of reducing the number of IO pins when using multiple DSA or DVGA chip with addressable function.

The BVA1762 is targeted for use in wireless infrastructure, point-to-point, or can be used for any general purpose wireless application.

### Application

- 5G/4G/3G Wireless infrastructure and other high performance RF application
- Microwave and Satellite Radio
- General purpose Wireless

**Table 1. Electrical Specifications<sup>1</sup> @ VDD = 5V**

Parameter		Condition	Min	Typ	Max	Unit
Operational Frequency Range			500		8000	MHz
Gain <sup>2</sup>		ATT = 0dB @ 3500MHz		19.7		dB
Attenuation Control range		0.25dB Step		0 - 31.75		dB
Attenuation Step				0.25		dB
Attenuation Accuracy	0.5GHz - 1GHz	Any bit or bit combination				±(0.25 + 2% of ATT setting)
	1GHz - 2GHz					±(0.25 + 3% of ATT setting)
	2GHz - 3GHz					±(0.25 + 3% of ATT setting)
	3GHz - 4GHz					±(0.25 + 5% of ATT setting)
	4GHz - 6GHz					±(0.25 + 5% of ATT setting)
	6GHz - 8GHz					±(0.5 + 5% of ATT setting)
Input Return loss	0.5GHz - 2GHz	ATT = 0dB				-11
	2GHz - 4GHz					-15
	4GHz - 6GHz					-9
	6GHz - 8GHz					-8
Output Return loss	0.5GHz - 2GHz	ATT = 0dB				-9
	2GHz - 4GHz					-10
	4GHz - 6GHz					-15
	6GHz - 8GHz					-9
Output Power for 1dB Compression		ATT = 0dB @ 3500MHz		20.7		dBm
Output Third Order Intercept Point <sup>3</sup>		ATT = 0dB @ 3500MHz		34.9		dBm
Noise Figure		ATT = 0dB @ 3500MHz		3.2		dB
DSA Switching time		50% CTRL to 90% or 10% RF		500	800	ns
AMP Switching time		50% CTRL to 90% or 10% RF		150		ns
Maximum Spurious level		Measured @ RF1, RF2 ports		< -145		dBm
Impedance				50		Ω

1. Device performance \_ measured on a BeRex Evaluation board at 25°C, 50 Ω system, VDD=+5.0V, measure on Evaluation Board (DSA to AMP)

2. Gain data has PCB & Connectors insertion loss de-embedded

3. OIP3 \_ measured with two tones at an output of 3dBm per tone separated by 1MHz.

Table 2. Electrical Specifications <sup>1</sup> @ VDD = 4V

Parameter		Condition	Min	Typ	Max	Unit
Operational Frequency Range			500		8000	MHz
Gain <sup>2</sup>		ATT = 0dB @ 3500MHz		19.1		dB
Attenuation Control range		0.25dB Step		0 - 31.75		dB
Attenuation Step				0.25		dB
Attenuation Accuracy	0.5GHz - 1GHz	Any bit or bit combination			±(0.25 + 2% of ATT setting)	dB
	1GHz - 2GHz				±(0.25 + 3% of ATT setting)	
	2GHz - 3GHz				±(0.25 + 3% of ATT setting)	
	3GHz - 4GHz				±(0.25 + 5% of ATT setting)	
	4GHz - 6GHz				±(0.25 + 5% of ATT setting)	
	6GHz - 8GHz				±(0.5 + 5% of ATT setting)	
Input Return loss	0.5GHz - 2GHz	ATT = 0dB	-11	-15		dB
	2GHz - 4GHz		-15	-16		
	4GHz - 6GHz		-9	-11		
	6GHz - 8GHz		-8	-10		
Output Return loss	0.5GHz - 2GHz	ATT = 0dB	-9	-16		dB
	2GHz - 4GHz		-10	-16		
	4GHz - 6GHz		-15	-18		
	6GHz - 8GHz		-9	-18		
Output Power for 1dB Compression		ATT = 0dB @ 3500MHz		19.1		dBm
Output Third Order Intercept Point <sup>3</sup>		ATT = 0dB @ 3500MHz		32.9		dBm
Noise Figure		ATT = 0dB @ 3500MHz		3.2		dB
DSA Switching time		50% CTRL to 90% or 10% RF		500	800	ns
AMP Switching time		50% CTRL to 90% or 10% RF		150		ns
Maximum Spurious level		Measured @ RF1, RF2 ports		< -145		dBm
Impedance				50		Ω

1. Device performance \_ measured on a BeRex Evaluation board at 25°C, 50 Ω system, VDD=+5.0V, measure on Evaluation Board (DSA to AMP)

2. Gain data has PCB & Connectors insertion loss de-embedded

3. OIP3 \_ measured with two tones at an output of 3dBm per tone separated by 1MHz.

**Table 3. Typical RF Performance (VDD = 5.0V) <sup>1</sup>**

Parameter	Frequency								Unit
	900 <sup>3</sup>	1800 <sup>4</sup>	2140 <sup>5</sup>	2650 <sup>5</sup>	3500 <sup>5</sup>	4650 <sup>6</sup>	5800 <sup>7</sup>	7200 <sup>7</sup>	
<b>Gain<sup>8</sup></b>	20.7	20.4	20.3	20.1	19.7	19.1	18.0	18.2	dB
<b>S11</b>	-18.2	-15.8	-16.2	-16.7	-18.7	-10.7	-9.4	-9.6	dB
<b>S22</b>	-16.2	-19.8	-29.8	-22.3	-11.5	-15.6	-25.8	-20.1	dB
<b>OIP3<sup>9</sup></b>	37.5	36.1	35.7	35.3	34.9	34.6	33.9	31.0	dBm
<b>P1dB</b>	20.1	20.8	20.9	20.8	20.7	20.4	18.8	16.5	dBm
<b>Noise Figure</b>	2.5	2.6	2.7	2.9	3.2	4.0	4.0	5.2	dB

**Table 4. Typical RF Performance (VDD = 4.0V) <sup>2</sup>**

Parameter	Frequency								Unit
	900 <sup>3</sup>	1800 <sup>4</sup>	2140 <sup>5</sup>	2650 <sup>5</sup>	3500 <sup>5</sup>	4650 <sup>6</sup>	5800 <sup>7</sup>	7200 <sup>7</sup>	
<b>Gain<sup>8</sup></b>	20.0	19.6	19.4	19.3	19.1	18.2	16.9	16.9	dB
<b>S11</b>	-15.3	-13.2	-13.5	-14.2	-21.7	-9.3	-8.3	-8.3	dB
<b>S22</b>	-22.3	-21.3	-26.4	-21.8	-13.5	-17.5	-18.3	-15.0	dB
<b>OIP3<sup>9</sup></b>	33.6	32.6	32.0	32.1	32.9	32.4	31.7	28.0	dBm
<b>P1dB</b>	18.3	19.2	19.2	19.0	19.1	18.9	17.1	14.9	dBm
<b>Noise Figure</b>	2.5	2.6	2.7	2.8	3.2	4.1	4.1	5.3	dB

1. Device performance \_ measured on a BeRex evaluation board at 25°C, VDD=+5.0V, 50 Ω system. (DSA to AMP)

2. Device performance \_ measured on a BeRex evaluation board at 25°C, VDD=+4.0V, 50 Ω system. (DSA to AMP)

3. 900MHz measured with application circuit refer to table 11.

4. 1800MHz, 2140MHz, 2650MHz measured with application circuit refer to table 14.

5. 3500MHz measured with application circuit refer to table 17.

6. 4650MHz measured with application circuit refer to table 20.

7. 5800MHz, 7000MHz measured with application circuit refer to table 23.

8. Gain data has PCB & Connectors insertion loss de-embedded.

9. OIP3 measured with two tones at an output of 3dBm per tone separated by 1MHz

**Table 5. Absolute Maximum Ratings**

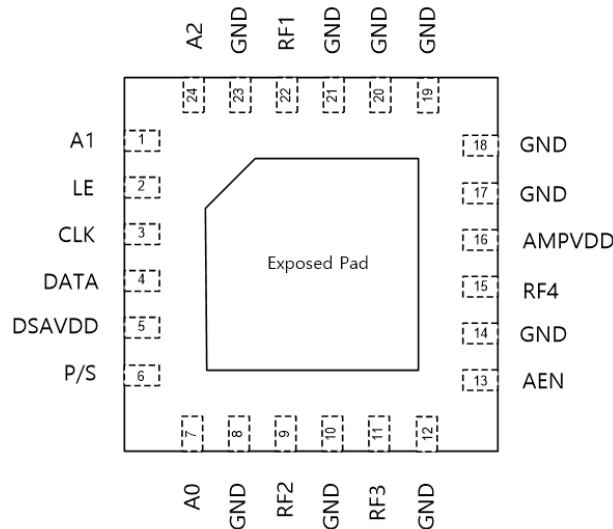
Parameter	Condition	Min	Typ	Max	Unit
Supply Voltage	AMP			5.5	V
	DSA			5.5	V
Supply Current	AMP			180	mA
	DSA			1000	uA
Digital input voltage	AMP Control Pin (AEN)	-0.3		5.25	V
	DSA Control Pin (LE, DATA, CLK, P/S, A0, A1, A2)	-0.3		3.6	V
Maximum input power	AMP			15	dBm
	DSA			30	dBm
Storage Temperature		-55		150	°C
Junction Temperature			150		°C

Operation of this device above any of these parameters may result in permanent damage.

**Table 6. Recommended Operating Conditions**

Parameter	Condition	Min	Typ	Max	Unit
Frequency Range	AMP + DSA	500		8000	MHz
Supply Voltage, VDD	AMP VDD	4	5	5.25	V
	DSA VDD	2.7		5.5	V
Current, IDD	AMP ON @ VDD=5V	90	110	130	mA
	AMP ON @ VDD=4V	45	55	65	mA
	AMP OFF			7	mA
	DSA	100	200	300	uA
AMP Control Voltage [AEN]	AMP ON	0		0.6	V
	AMP OFF	1.17		VDD	V
AEN pin Current	AMP OFF		150		uA
DSA Control Voltage	Digital Input High	1.17		3.6	V
	Digital Input Low	-0.3		0.6	V
DSA Control pin Current	Digital Input High			20	uA
Operating Temperature	AMP + DSA	-40		105	°C

Specifications are not guaranteed over all recommended operating conditions.

**Figure 3. Pin Configuration (Top View)**

**Table 7. Pin Description**

Pin	Pin name	Description
1	A1	Address bit A1 connection.
2	LE	Latch Enable input
3	CLK	Serial interface clock input
4	DATA	Serial interface data input
5	DSAVDD	DSA Power Supply input
6	P/S	Serial Mode Select. This pin have to be set to HIGH.
7	A0	Address bit A0 connection.
9	RF2 <sup>1</sup>	DSA output port (Attenuator RF Output) This pin should be connected to RF3(Pin 11) with DC blocking capacitor.
11	RF3	Amplifier RF Input This pin should be connected to RF2(Pin 9) with DC blocking capacitor.
13	AEN	Amplifier Enable input. Amplifier is enabled when this pin is set to Low .
15	RF4	Amplifier RF Output This pin is a final RF output port. (DSA + Amp structure)
22	RF1 <sup>1</sup>	DSA input port (Attenuator RF Input) This pin is a main RF input port. (DSA + Amp structure)
24	A2	Address bit A2 connection.
8, 10, 12, 14, 17, 18, 19, 20, 21, 23	GND	Ground, These pins must be connected to ground
16	AMPVDD	Amplifier power supply input

**Note:** 1. The RF pins do not require DC blocking capacitors for proper operation if the 0V DC requirement is met.

### Programming Options

The BDA1762 is programmed to operate only in serial mode. It operates in serial mode when the P/S pin is High, and when P/S pin is low, the internal DSA is fixed as Max attenuation(31.75dB), so the P/S pin must be set to High to use the serial mode.

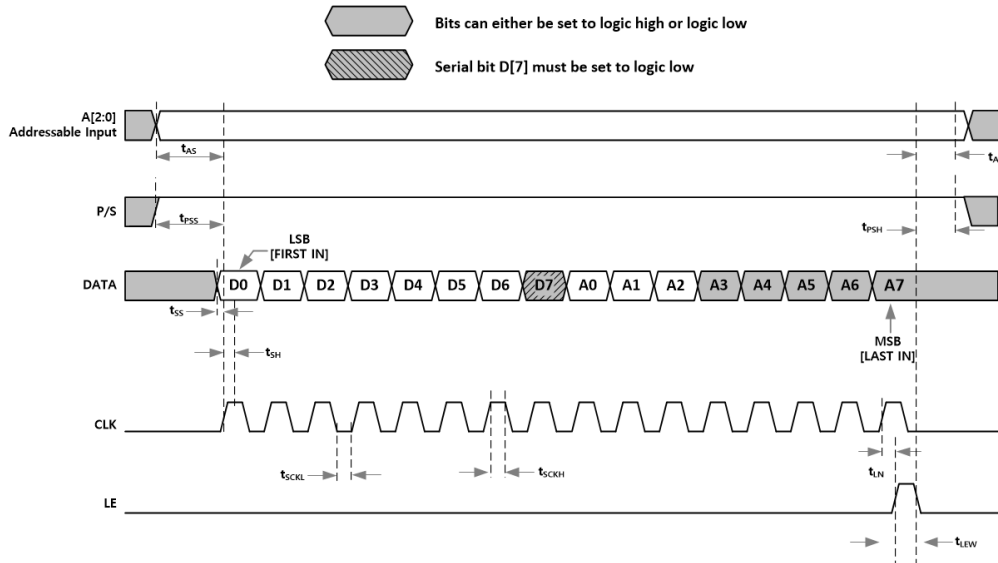
### Serial Control Mode

The serial interface is a 7-bit shift register to shift in the data LSB (D0) first. It is controlled by three CMOS-compatible signals: DATA, CLK, and Latch Enable (LE).

Table 8. Truth Table for Serial Control Word

Digital Control Input								Attenuation state (dB)
D7 (MSB)	D6	D5	D4	D3	D2	D1	D0 (LSB)	
LOW	LOW	LOW	LOW	LOW	LOW	LOW	LOW	0
LOW	LOW	LOW	LOW	LOW	LOW	LOW	HIGH	0.25
LOW	LOW	LOW	LOW	LOW	LOW	HIGH	LOW	0.5
LOW	LOW	LOW	LOW	LOW	HIGH	LOW	LOW	1.0
LOW	LOW	LOW	LOW	HIGH	LOW	LOW	LOW	2.0
LOW	LOW	LOW	HIGH	LOW	LOW	LOW	LOW	4.0
LOW	LOW	HIGH	LOW	LOW	LOW	LOW	LOW	8.0
LOW	HIGH	LOW	LOW	LOW	LOW	LOW	LOW	16.0
LOW	HIGH	HIGH	HIGH	HIGH	HIGH	HIGH	HIGH	31.75

Figure 4. Serial Mode Timing Diagram



The serial interface is a 16-bit shift register made up of two words. The first 8-bit word is the Attenuation word, which controls the DSA state.

The second word is the address word, which uses only 3 of 8-bits that must match the hard wired A0 – A2 programming in order to change the DSA state. If no external connections are made to A0 – A2 then internally they will default to 000 due to internal pull down resistors.

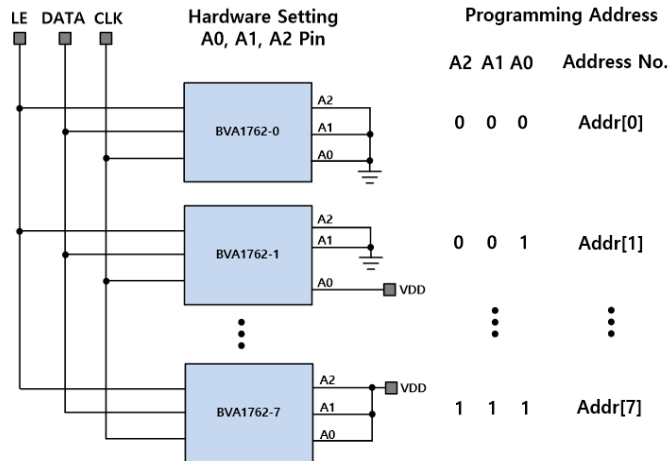
If these 3 external preset address bits are not matched with the SPI loaded address bits then the current attenuator state will remain unchanged.

This allows up to 8 serial-controlled devices to be used on a single board, which share a common DATA, CLK and LE. (Figure 5)

Table 9. Serial Interface Timing Specifications

Symbol	Parameter	Min	Typ	Max	Unit
$f_{CLK}$	Serial data clock frequency			10	MHz
$t_{AS}$	Address setup time	100			ns
$t_{AH}$	Address hold time	100			ns
$t_{PSS}$	P/S setup time	100			ns
$t_{PSH}$	P/S hold time	100			ns
$t_{SS}$	Serial Data setup time	10			ns
$t_{SH}$	Serial Data hold time	10			ns
$t_{SCKH}$	Serial clock high time	30			ns
$t_{SCKL}$	Serial clock low time	30			ns
$t_{LN}$	LE setup time	10			ns
$t_{LEW}$	Minimum LE pulse width	30			ns

**Figure 5. Multi Device Addressing Scheme using SPI**



**Table 10. Truth Table for Address Control Word**

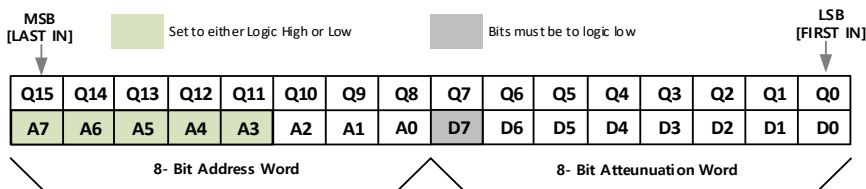
Address Digital Control Input									Address Setting	Addr No.
A7 (MSB)	A6	A5	A4	A3	A2	A1	A0 (LSB)			
X	X	X	X	X	LOW	LOW	LOW	000	Addr[0]	
X	X	X	X	X	LOW	LOW	HIGH	001	Addr[1]	
X	X	X	X	X	LOW	HIGH	LOW	010	Addr[2]	
X	X	X	X	X	LOW	HIGH	HIGH	011	Addr[3]	
X	X	X	X	X	HIGH	LOW	LOW	100	Addr[4]	
X	X	X	X	X	HIGH	LOW	HIGH	101	Addr[5]	
X	X	X	X	X	HIGH	HIGH	LOW	110	Addr[6]	
X	X	X	X	X	HIGH	HIGH	HIGH	111	Addr[7]	

### Serial Register Map

The BVA1762 can be programmed via the serial control on the rising edge of Latch Enable (LE) which loads the last 8-bits attenuation word and 8-bits address word in the SHIFT Register. Data is clocked in LSB(D0) first.

The shift register must be loaded while LE is kept LOW to prevent changing the attenuation value during data is inputted.

**Figure 6. Serial Register Map**



The serial register consist of 16 bits as shown in Figure 6. First 8 bits from LSB are Attenuation word, 8 bits after that are Address word. The Attenuation word is DSA attenuation control bit and the Address word is static logical bit determined by A0, A1 and A2 digital inputs. The attenuation word is derived directly from the value of the attenuation state. To find the attenuation word, multiply the value of the state by four because of 0.25dB step up to 31.75dB (total 127 Attenuation state), then convert to binary.

For example, to program attenuation 15.75dB state of Addr[5] BVA1762 :

Attenuation State	Address state
$4 \times 15.75 = 63$	Digital input of A2, A1, A0 pin = 101
63 -> 00111111	A7 - A0 : xxxxx101

Serial Input : xxxxx10100111111

x	x	x	x	x	1	0	1	0	0	1	1	1	1	1	1
A7	A6	A5	A4	A3	A2	A1	A0	D7	D6	D5	D4	D3	D2	D1	D0

### Power-Up state Settings

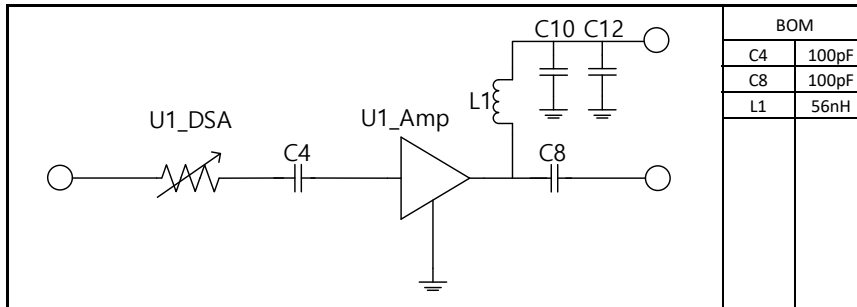
The BVA1762 will always initialize to the minimum Gain state (Max Attenuation = 31.75dB) on power-up and will remain in this setting until the user latches in the next programming word.



### Typical RF Performance Plot - BVA1762 EVK - PCB (Application Circuit:500 ~ 1100MHz)

Typical Performance Data @ 25°C and VDD = 5V unless otherwise noted and Application Circuit refer to Table 11

Table 11. 500 ~ 1100MHz RF Application Circuit



This value can be changed little by little according to the frequency band and bandwidth.

Table 12. Typical RF Performance @ VDD = 5V

Parameter	Frequency			Unit
	700	800	900	
Gain <sup>1</sup>	20.6	20.7	20.7	dB
S11	-15.5	-17.3	-18.2	dB
S22	-12.4	-14.4	-16.2	dB
OIP3 <sup>2</sup>	38.0	37.7	37.5	dBm
P1dB	19.3	19.7	20.1	dBm
Noise Figure	2.4	2.4	2.5	dB

- Gain data has PCB & Connectors insertion loss de-embedded
- OIP3\_ measured with two tones at an output of 3 dBm per tone separated by 1 MHz.

Table 13. Typical RF Performance @ VDD = 4.0V

Parameter	Frequency			Unit
	700	800	900	
Gain <sup>1</sup>	19.9	20.0	20.0	dB
S11	-14.7	-15.3	-15.3	dB
S22	-15.7	-18.9	-22.3	dB
OIP3 <sup>2</sup>	33.5	33.5	33.6	dBm
P1dB	17.5	17.9	18.3	dBm
Noise Figure	2.4	2.4	2.5	dB

- Gain data has PCB & Connectors insertion loss de-embedded
- OIP3\_ measured with two tones at an output of 3 dBm per tone separated by 1 MHz.

Figure 7. Gain vs. Frequency @ VDD = 5V over Temperature

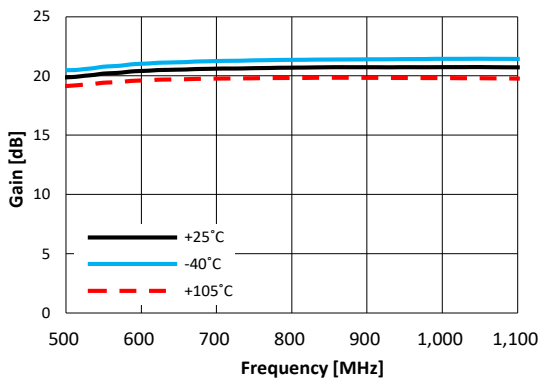
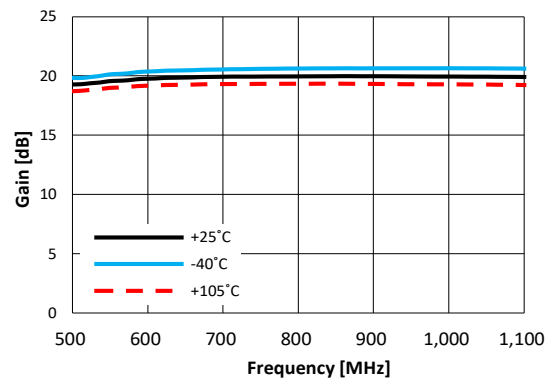


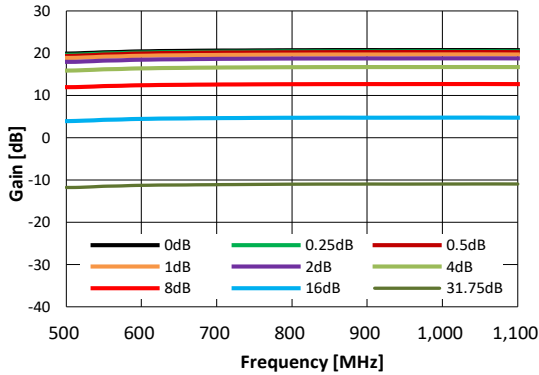
Figure 8. Gain vs. Frequency @ VDD = 4.0V over Temperature



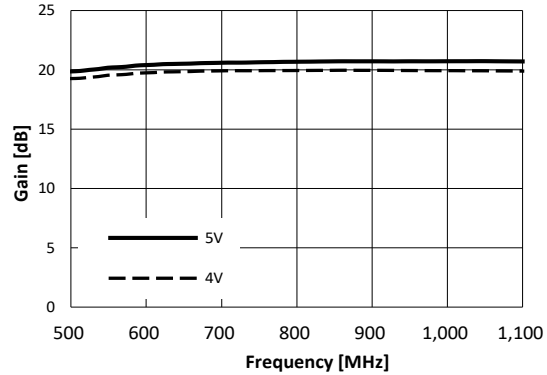
### Typical RF Performance Plot - BVA1762 EVK - PCB (Application Circuit:500 ~ 1100MHz)

Typical Performance Data @ 25°C and VDD = 5V unless otherwise noted and Application Circuit refer to Table 11

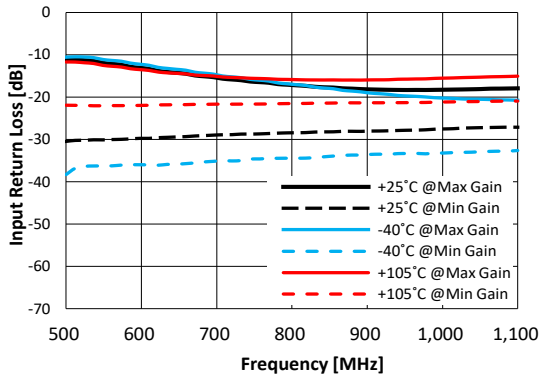
**Figure 9. Gain vs. Frequency**  
over Major Attenuation States



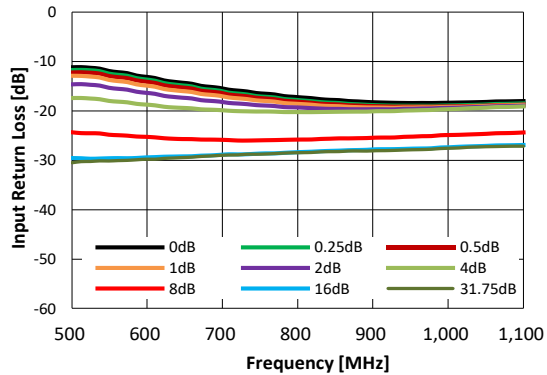
**Figure 10. Gain vs. Frequency vs VDD**  
Max Gain States



**Figure 11. Input Return Loss vs. Frequency**  
over Temperature (Min<sup>1</sup> / Max Gain State)

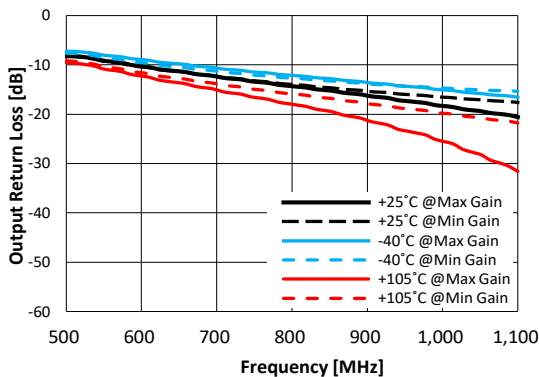


**Figure 12. Input Return Loss vs. Frequency**  
Over Major Attenuation States

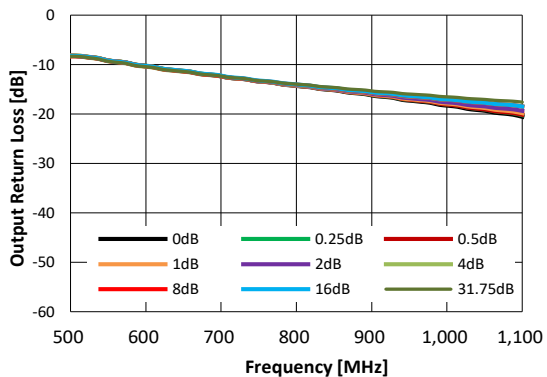


1. Min Gain was measured in the state is set with attenuation 31.75dB.

**Figure 13. Output Return Loss vs. Frequency**  
over Temperature (Min<sup>1</sup> / Max Gain State)



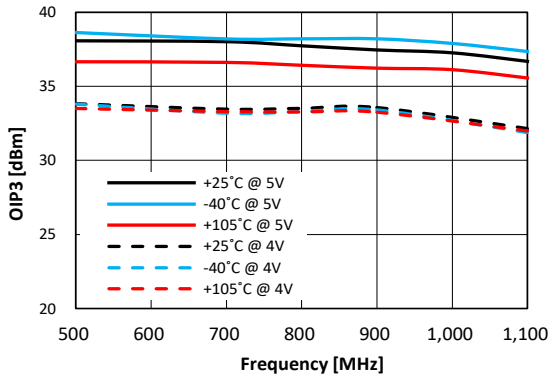
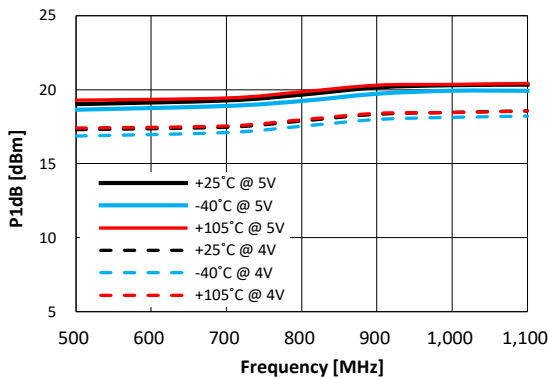
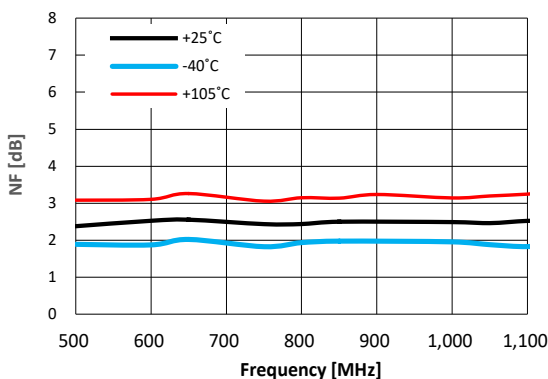
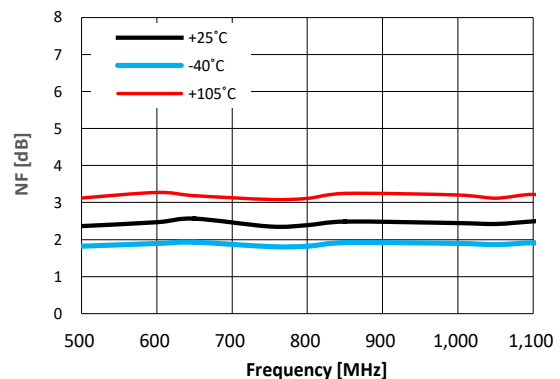
**Figure 14. Output Return Loss vs. Frequency**  
over Major Attenuation States



1. Min Gain was measured in the state is set with attenuation 31.75dB.

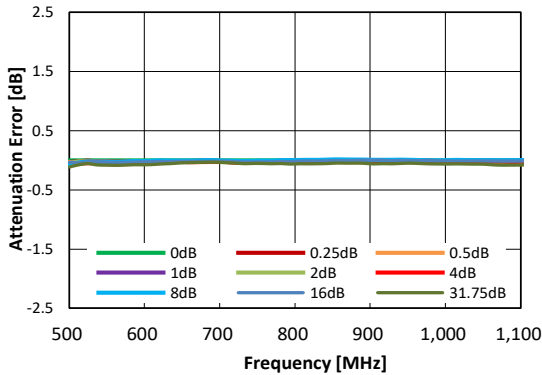
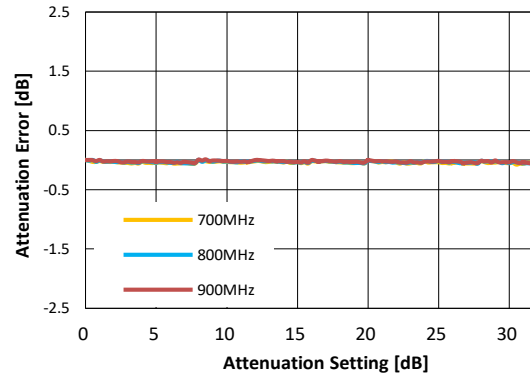
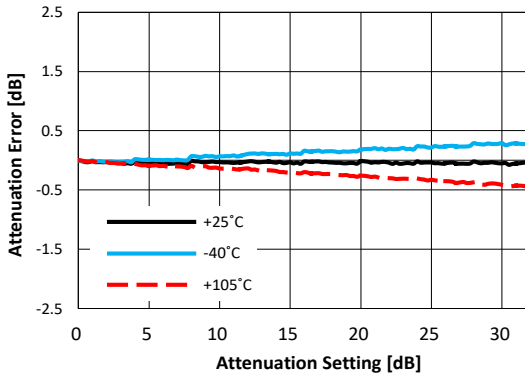
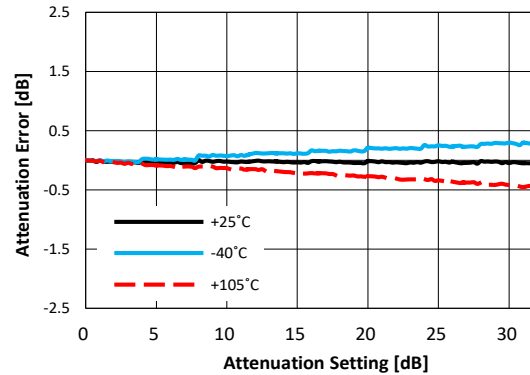
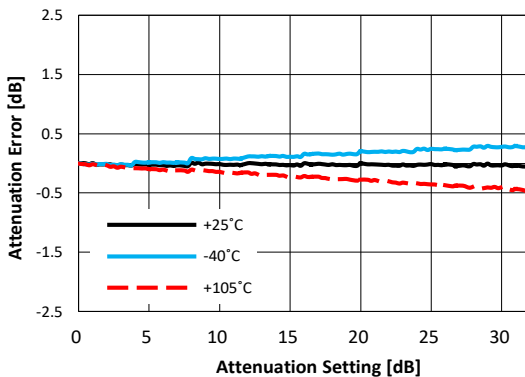
**Typical RF Performance Plot - BVA1762 EVK - PCB (Application Circuit:500 ~ 1100MHz)**

Typical Performance Data @ 25°C and VDD = 5V unless otherwise noted and Application Circuit refer to Table 11

**Figure 15. OIP3 vs. Frequency vs. VDD**  
 Over Temperature (Max Gain State)

**Figure 16. P1dB vs. Frequency vs. VDD**  
 Over Temperature (Max Gain State)

**Figure 17. Noise Figure vs. Frequency @ VDD = 5V**  
 Over Temperature (Max Gain State)

**Figure 18. Noise Figure vs. Frequency @ VDD = 4.0V**  
 Over Temperature (Max Gain State)


**Typical RF Performance Plot - BVA1762 EVK - PCB (Application Circuit:500 ~ 1100MHz)**

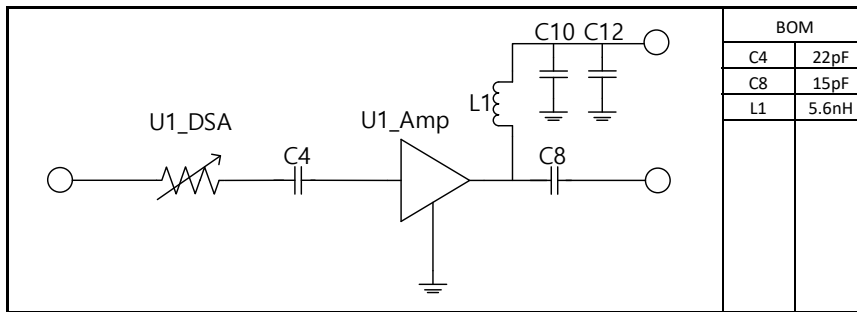
Typical Performance Data @ 25°C and VDD = 5V unless otherwise noted and Application Circuit refer to Table 11

**Figure 19. Attenuation Error vs Frequency**  
 over Major Attenuation Steps

**Figure 20. Attenuation Error vs Attenuation Setting**  
 over Major Frequency (Max Gain State)

**Figure 21. Attenuation Error at 700MHz vs Temperature**  
 Over All Attenuation States

**Figure 22. Attenuation Error at 800MHz vs Temperature**  
 Over All Attenuation States

**Figure 23. Attenuation Error at 900MHz vs Temperature**  
 Over All Attenuation States


### Typical RF Performance Plot - BVA1762 EVK - PCB (Application Circuit:1.7 ~ 2.7GHz)

Typical Performance Data @ 25°C and VDD = 5V unless otherwise noted and Application Circuit refer to Table 14

Table 14. 1.7 ~ 2.7GHz RF Application Circuit



This value can be changed little by little according to the frequency band and bandwidth.

Table 15. Typical RF Performance @ VDD = 5V

Parameter	Frequency			Unit
	1800	2140	2650	
Gain <sup>1</sup>	20.4	20.3	20.1	dB
S11	-15.8	-16.2	-16.7	dB
S22	-19.8	-29.8	-22.3	dB
OIP3 <sup>2</sup>	36.1	35.7	35.3	dBm
P1dB	20.8	20.9	20.8	dBm
Noise Figure	2.6	2.7	2.9	dB

- Gain data has PCB & Connectors insertion loss de-embedded
- OIP3\_ measured with two tones at an output of 3 dBm per tone separated by 1MHz.

Table 16. Typical RF Performance @ VDD = 4.0V

Parameter	Frequency			Unit
	1800	2140	2650	
Gain <sup>1</sup>	19.6	19.4	19.3	dB
S11	-13.2	-13.5	-14.2	dB
S22	-21.3	-26.4	-21.8	dB
OIP3 <sup>2</sup>	32.6	32.0	32.1	dBm
P1dB	19.2	19.2	19.0	dBm
Noise Figure	2.6	2.7	2.8	dB

- Gain data has PCB & Connectors insertion loss de-embedded
- OIP3\_ measured with two tones at an output of 3 dBm per tone separated by 1MHz.

Figure 24. Gain vs. Frequency @ VDD = 5V over Temperature

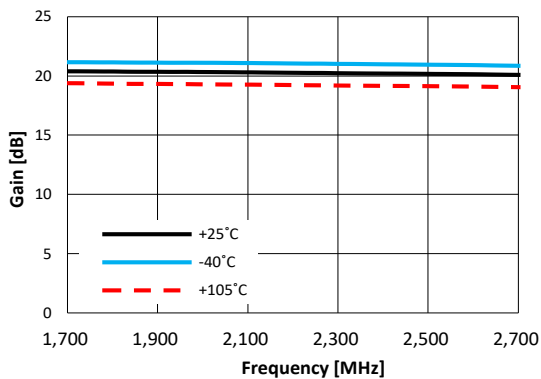
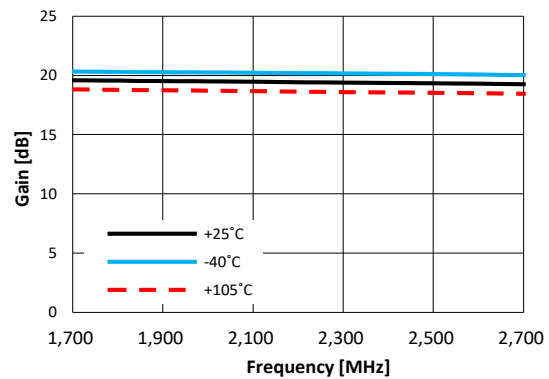


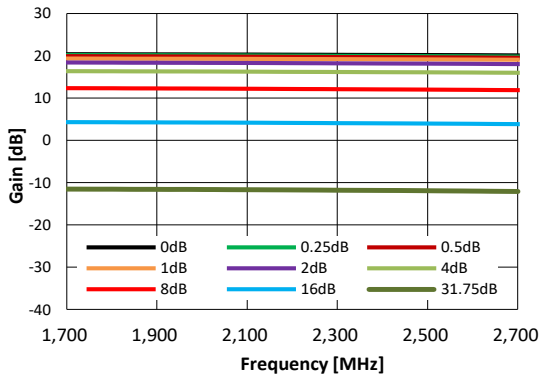
Figure 25. Gain vs. Frequency @ VDD = 4.0V over Temperature



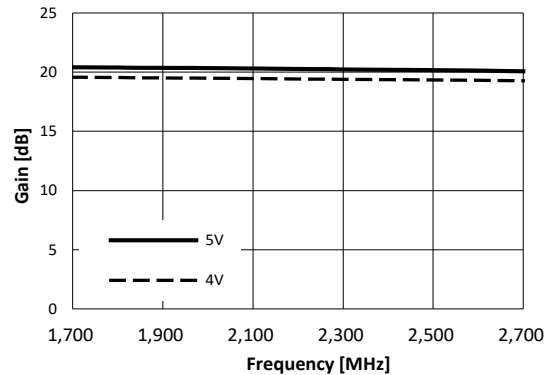
### Typical RF Performance Plot - BVA1762 EVK - PCB (Application Circuit:1.7 ~ 2.7GHz)

Typical Performance Data @ 25°C and VDD = 5V unless otherwise noted and Application Circuit refer to Table 14

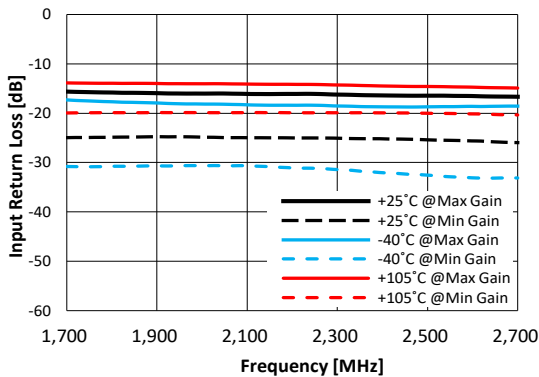
**Figure 26. Gain vs. Frequency**  
over Major Attenuation States



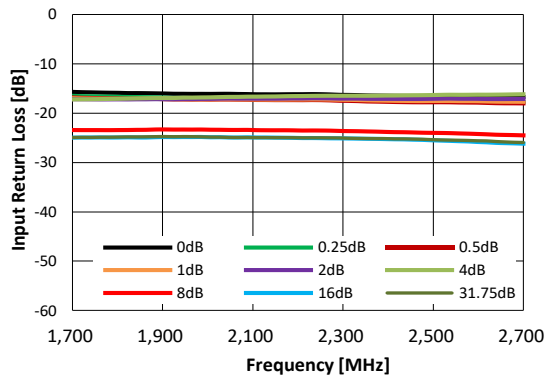
**Figure 27. Gain vs. Frequency vs VDD**  
Max Gain States



**Figure 28. Input Return Loss vs. Frequency**  
over Temperature (Min<sup>1</sup> / Max Gain State)

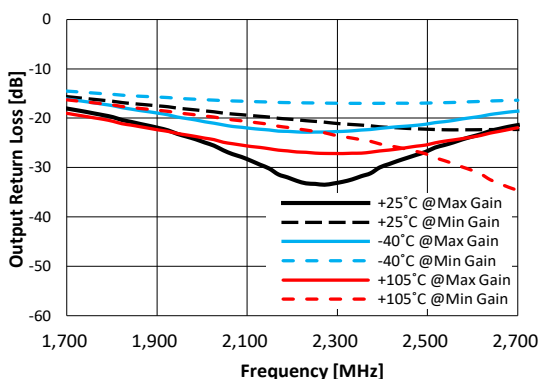


**Figure 29. Input Return Loss vs. Frequency**  
Over Major Attenuation States

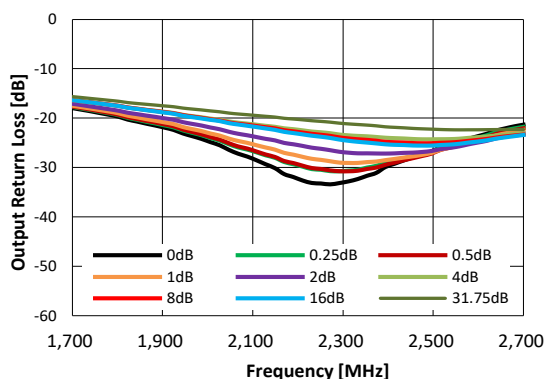


1.Min Gain was measured in the state is set with attenuation 31.75dB.

**Figure 30. Output Return Loss vs. Frequency**  
over Temperature (Min<sup>1</sup> / Max Gain State)



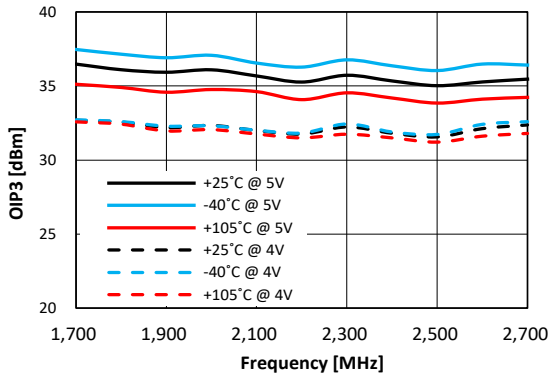
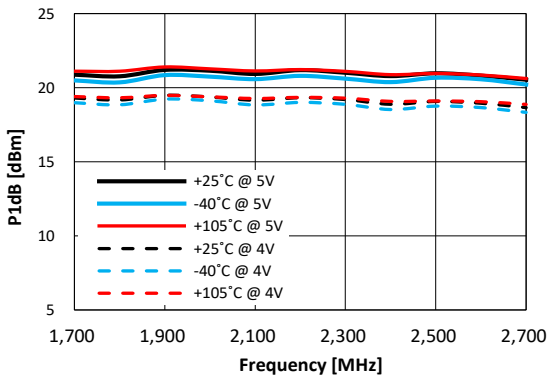
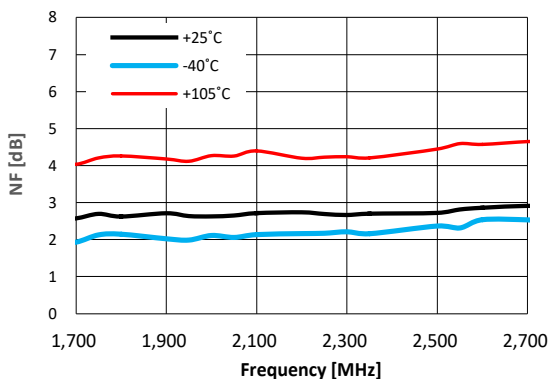
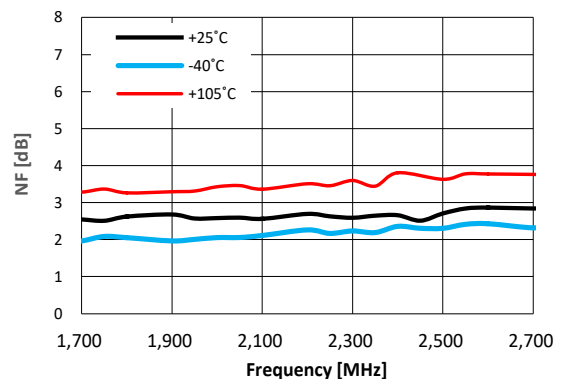
**Figure 31. Output Return Loss vs. Frequency**  
over Major Attenuation States



1.Min Gain was measured in the state is set with attenuation 31.75dB.

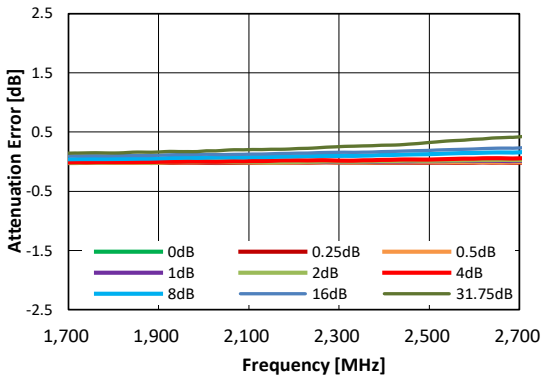
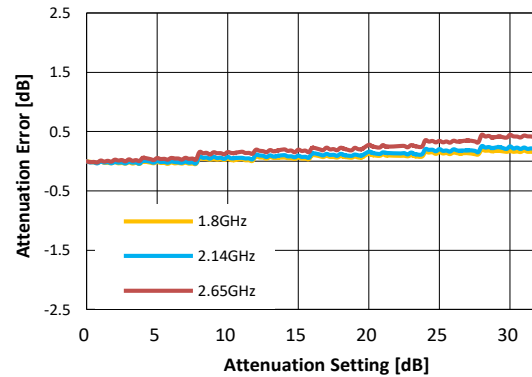
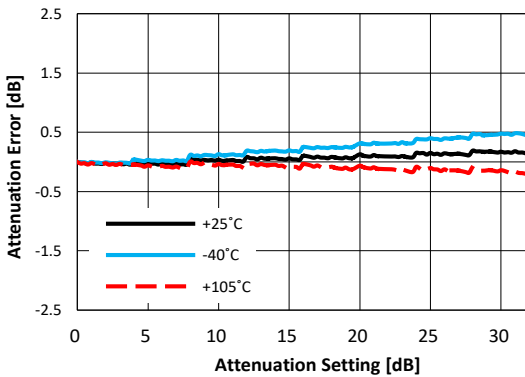
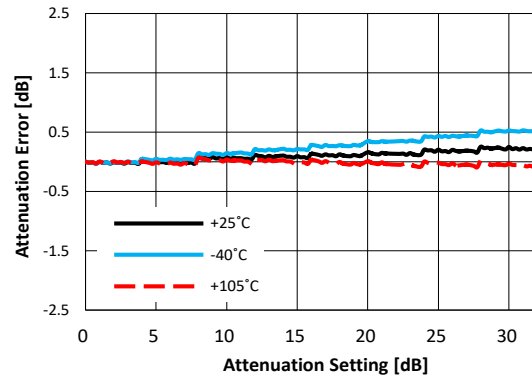
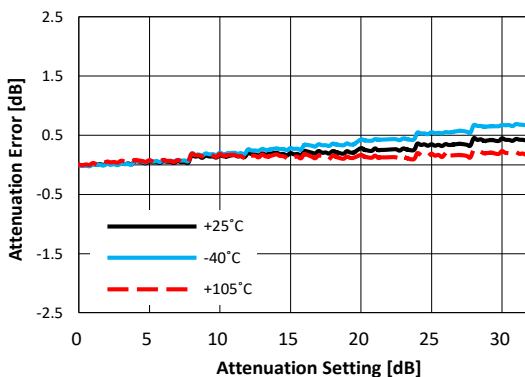
**Typical RF Performance Plot - BVA1762 EVK - PCB (Application Circuit:1.7 ~ 2.7GHz)**

Typical Performance Data @ 25°C and VDD = 5V unless otherwise noted and Application Circuit refer to Table 14

**Figure 32. OIP3 vs. Frequency vs. VDD**  
 Over Temperature (Max Gain State)

**Figure 33. P1dB vs. Frequency vs. VDD**  
 Over Temperature (Max Gain State)

**Figure 34. Noise Figure vs. Frequency @ VDD = 5V**  
 Over Temperature (Max Gain State)

**Figure 35. Noise Figure vs. Frequency @ VDD = 4.0V**  
 Over Temperature (Max Gain State)


**Typical RF Performance Plot - BVA1762 EVK - PCB (Application Circuit:1.7~ 2.7GHz)**

Typical Performance Data @ 25°C and VDD = 5V unless otherwise noted and Application Circuit refer to Table 14

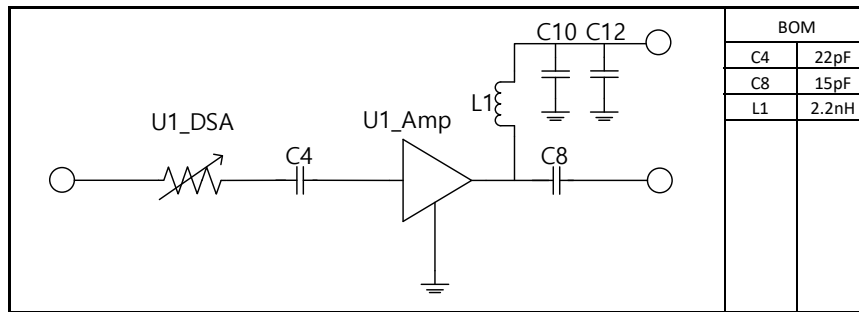
**Figure 36. Attenuation Error vs Frequency**  
 over Major Attenuation Steps

**Figure 37. Attenuation Error vs Attenuation Setting**  
 over Major Frequency (Max Gain State)

**Figure 38. Attenuation Error at 1.8GHz vs Temperature**  
 Over All Attenuation States

**Figure 39. Attenuation Error at 2.14GHz vs Temperature**  
 Over All Attenuation States

**Figure 40. Attenuation Error at 2.65GHz vs Temperature**  
 Over All Attenuation States




### Typical RF Performance Plot - BVA1762 EVK - PCB (Application Circuit:3.3 ~ 4GHz)

Typical Performance Data @ 25°C and VDD = 5V unless otherwise noted and Application Circuit refer to Table 17

Table 17. 3.3 ~ 4GHz RF Application Circuit



This value can be changed little by little according to the frequency band and bandwidth.

Table 18. Typical RF Performance @ VDD = 5V

Parameter	Frequency			Unit
	3500	3700	3900	
Gain <sup>1</sup>	19.7	19.6	19.5	dB
S11	-18.7	-18.6	-18.8	dB
S22	-11.5	-10.9	-10.6	dB
OIP3 <sup>2</sup>	34.9	35.1	34.8	dBm
P1dB	20.7	20.2	20.0	dBm
Noise Figure	3.2	3.3	3.1	dB

1. Gain data has PCB & Connectors insertion loss de-embedded  
 2. OIP3 \_ measured with two tones at an output of 3 dBm per tone separated by 1MHz.

Table 19. Typical RF Performance @ VDD = 4.0V

Parameter	Frequency			Unit
	3500	3700	3900	
Gain <sup>1</sup>	19.1	19.0	18.8	dB
S11	-21.7	-20.5	-19.6	dB
S22	-13.5	-12.7	-12.3	dB
OIP3 <sup>2</sup>	32.9	33.3	33.1	dBm
P1dB	19.1	18.6	18.4	dBm
Noise Figure	3.2	3.3	3.3	dB

1. Gain data has PCB & Connectors insertion loss de-embedded  
 2. OIP3 \_ measured with two tones at an output of 3 dBm per tone separated by 1MHz.

Figure 41. Gain vs. Frequency @ VDD = 5V over Temperature

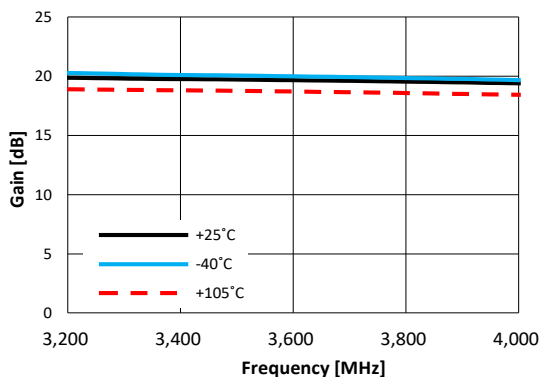
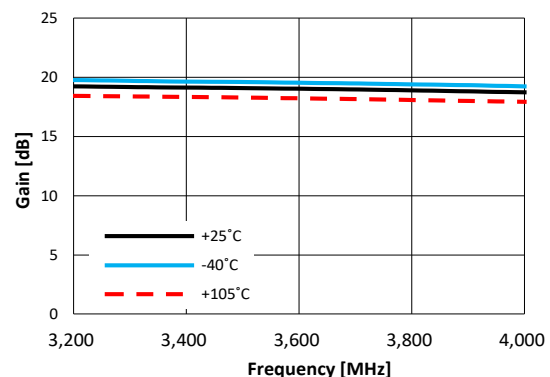


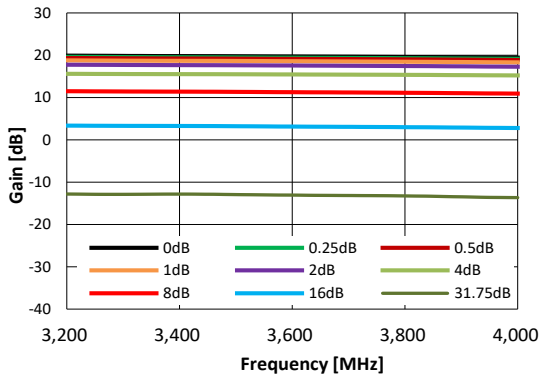
Figure 42. Gain vs. Frequency @ VDD = 4.0V over Temperature



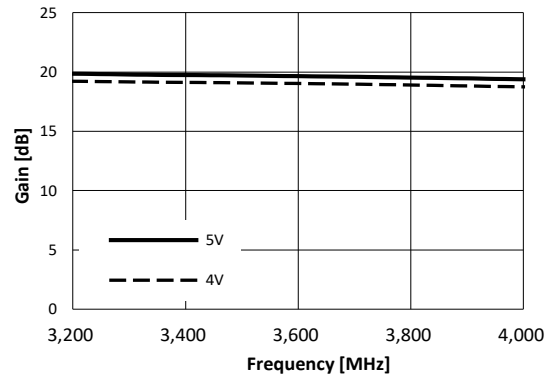
### Typical RF Performance Plot - BVA1762 EVK - PCB (Application Circuit:3.3 ~ 4GHz)

Typical Performance Data @ 25°C and VDD = 5V unless otherwise noted and Application Circuit refer to Table 17

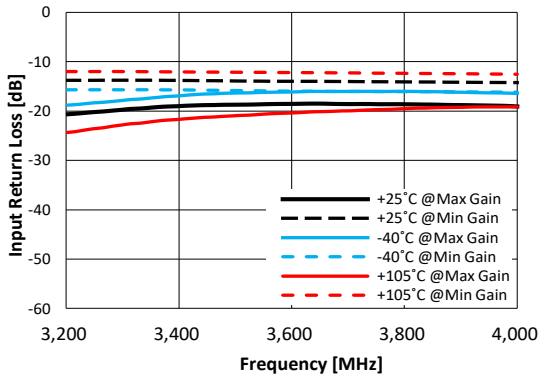
**Figure 43. Gain vs. Frequency**  
over Major Attenuation States



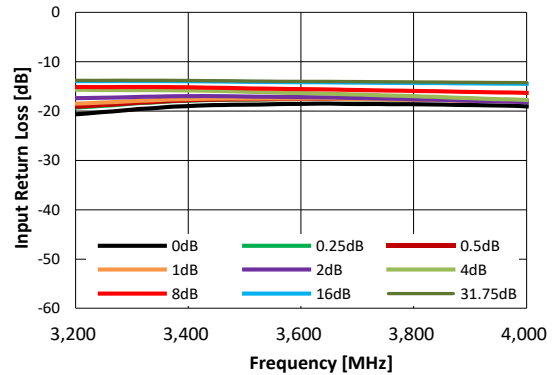
**Figure 44. Gain vs. Frequency vs VDD**  
Max Gain States



**Figure 45. Input Return Loss vs. Frequency**  
over Temperature (Min<sup>1</sup> / Max Gain State)

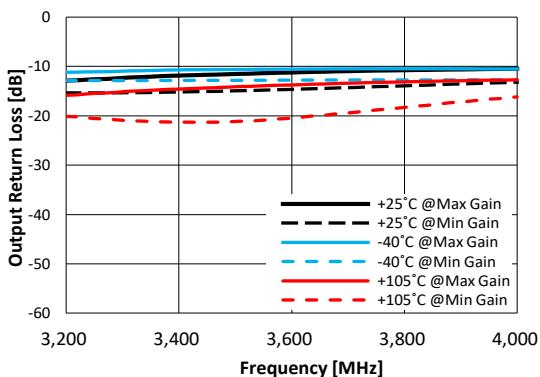


**Figure 46. Input Return Loss vs. Frequency**  
Over Major Attenuation States

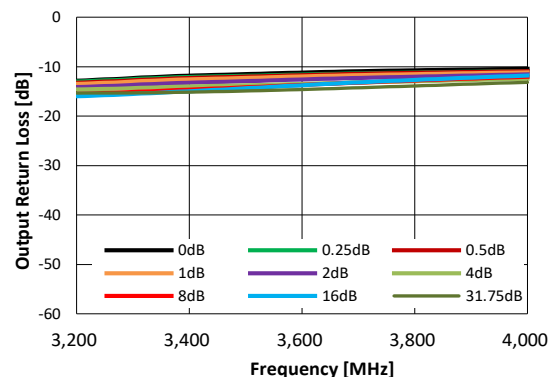


1.Min Gain was measured in the state is set with attenuation 31.75dB.

**Figure 47. Output Return Loss vs. Frequency**  
over Temperature (Min<sup>1</sup> / Max Gain State)



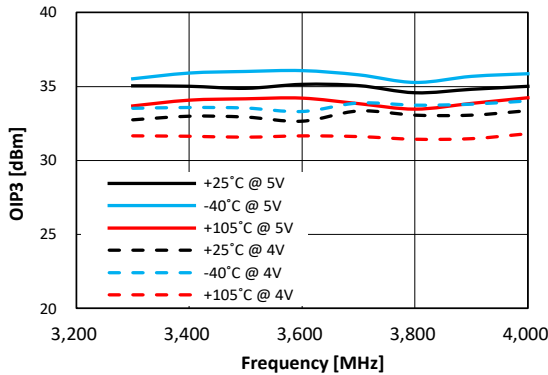
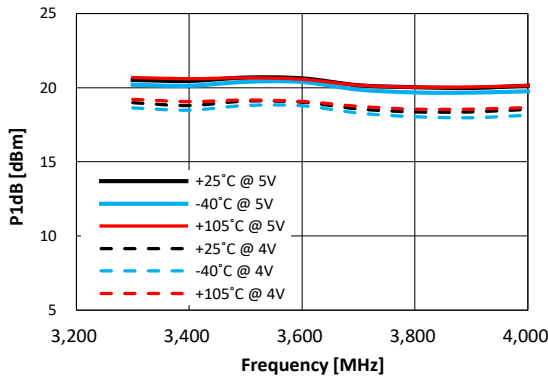
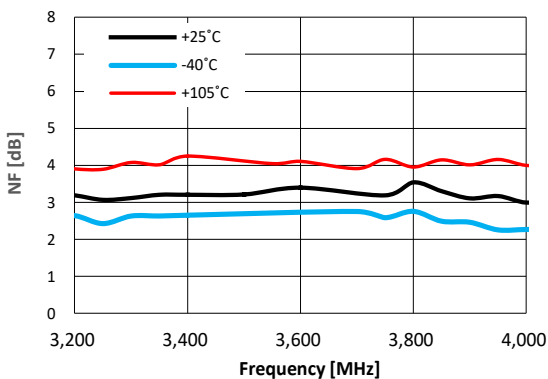
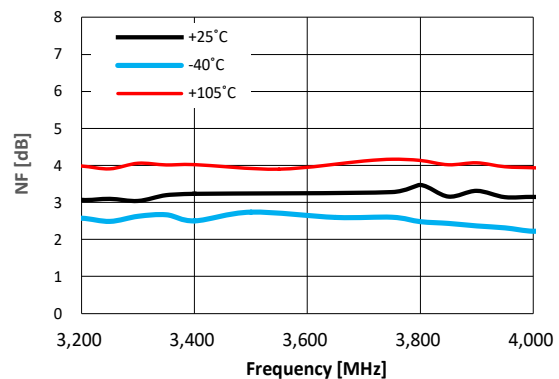
**Figure 48. Output Return Loss vs. Frequency**  
over Major Attenuation States



1.Min Gain was measured in the state is set with attenuation 31.75dB.

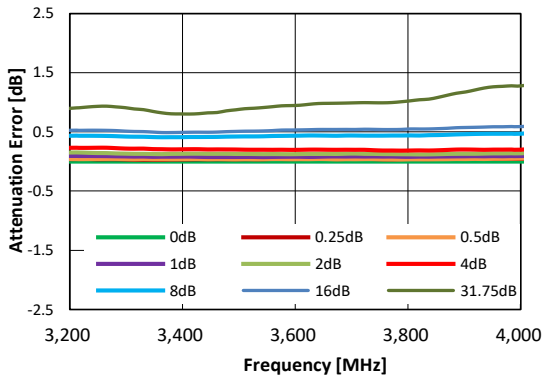
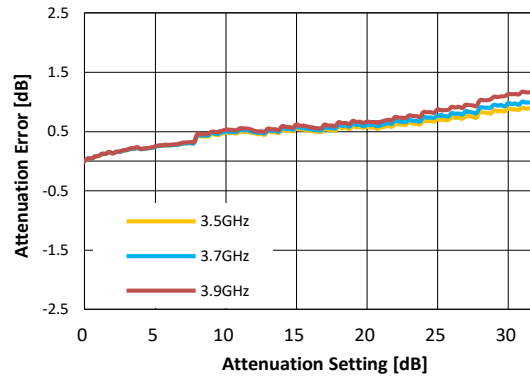
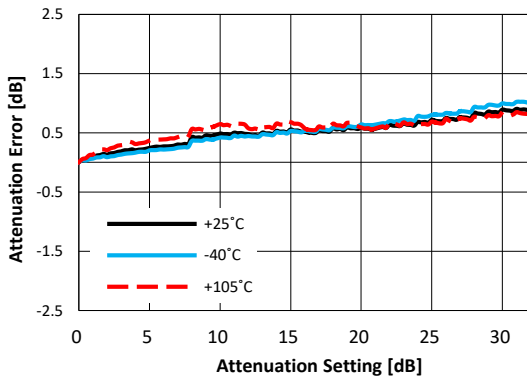
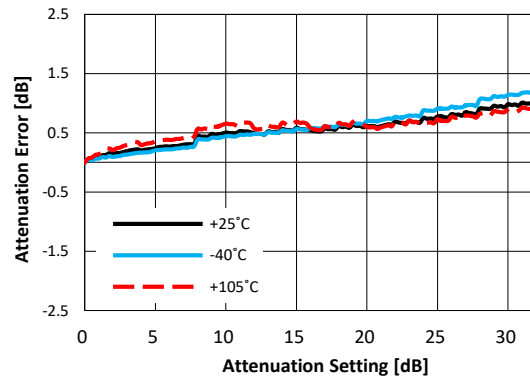
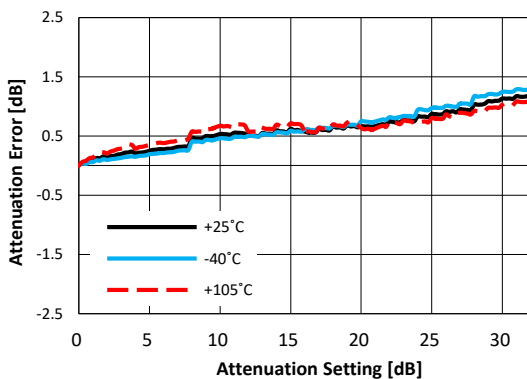
**Typical RF Performance Plot - BVA1762 EVK - PCB (Application Circuit:3.3 ~ 4GHz)**

Typical Performance Data @ 25°C and VDD = 5V unless otherwise noted and Application Circuit refer to Table 17

**Figure 49. OIP3 vs. Frequency vs. VDD**  
 Over Temperature (Max Gain State)

**Figure 50. P1dB vs. Frequency vs. VDD**  
 Over Temperature (Max Gain State)

**Figure 51. Noise Figure vs. Frequency @ VDD = 5V**  
 Over Temperature (Max Gain State)

**Figure 52. Noise Figure vs. Frequency @ VDD = 4.0V**  
 Over Temperature (Max Gain State)


**Typical RF Performance Plot - BVA1762 EVK - PCB (Application Circuit:3.3~ 4GHz)**

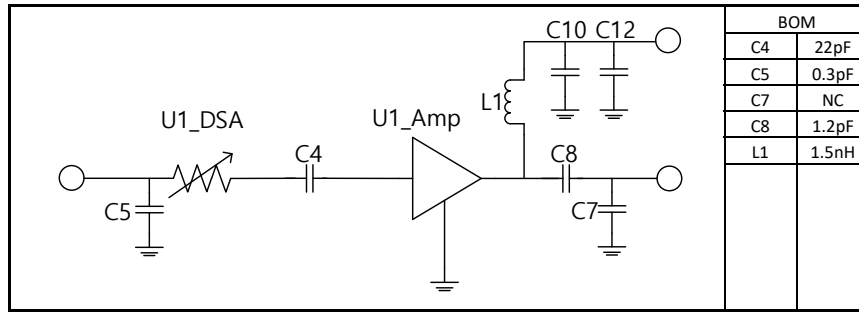
Typical Performance Data @ 25°C and VDD = 5V unless otherwise noted and Application Circuit refer to Table 17

**Figure 53. Attenuation Error vs Frequency over Major Attenuation Steps**

**Figure 54. Attenuation Error vs Attenuation Setting over Major Frequency (Max Gain State)**

**Figure 55. Attenuation Error at 3.5GHz vs Temperature Over All Attenuation States**

**Figure 56. Attenuation Error at 3.7GHz vs Temperature Over All Attenuation States**

**Figure 57. Attenuation Error at 3.9GHz vs Temperature Over All Attenuation States**


### Typical RF Performance Plot - BVA1762 EVK - PCB (Application Circuit:4.2 ~ 5.0GHz)

Typical Performance Data @ 25°C and VDD = 5V unless otherwise noted and Application Circuit refer to Table 20

Table 20. 4.2 ~ 5.0GHz RF Application Circuit



This value can be changed little by little according to the frequency band and bandwidth.

Table 21. Typical RF Performance @ VDD = 5V

Parameter	Frequency			Unit
	4400	4650	4900	
Gain <sup>1</sup>	19.3	19.1	18.8	dB
S11	-11.1	-10.7	-10.5	dB
S22	-16.3	-15.6	-16.0	dB
OIP3 <sup>2</sup>	33.9	34.6	35.1	dBm
P1dB	21.3	20.4	20.3	dBm
Noise Figure	4.0	4.0	4.3	dB

1. Gain data has PCB & Connectors insertion loss de-embedded  
 2. OIP3 \_ measured with two tones at an output of 3 dBm per tone separated by 1MHz.

Table 22. Typical RF Performance @ VDD = 4.0V

Parameter	Frequency			Unit
	4400	4650	4900	
Gain <sup>1</sup>	18.4	18.2	17.9	dB
S11	-9.7	-9.3	-9.2	dB
S22	-17.4	-17.5	-19.0	dB
OIP3 <sup>2</sup>	31.1	32.4	33.4	dBm
P1dB	19.5	18.9	18.8	dBm
Noise Figure	4.3	4.1	4.4	dB

1. Gain data has PCB & Connectors insertion loss de-embedded  
 2. OIP3 \_ measured with two tones at an output of 3 dBm per tone separated by 1MHz.

Figure 58. Gain vs. Frequency @ VDD = 5V over Temperature

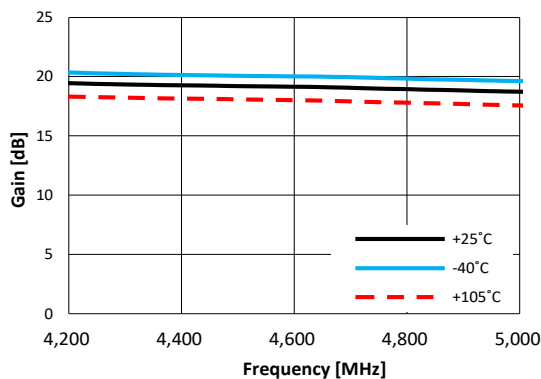
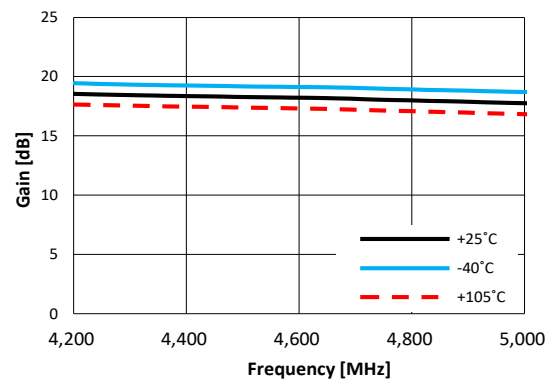
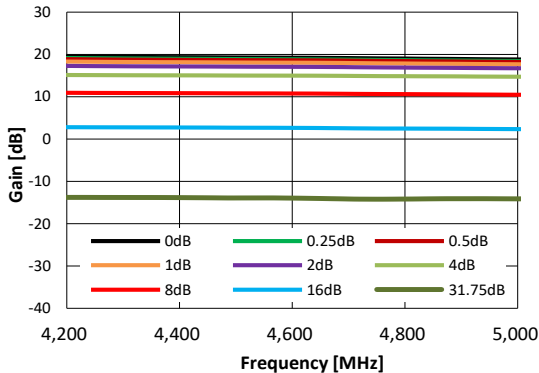
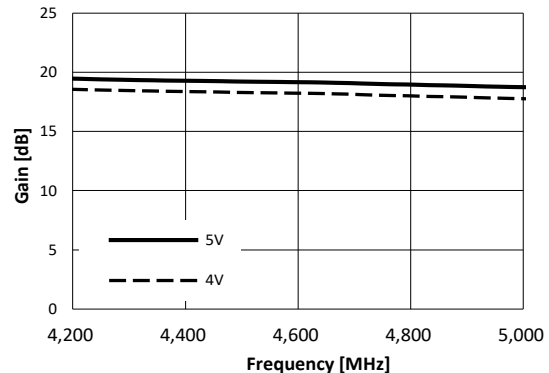
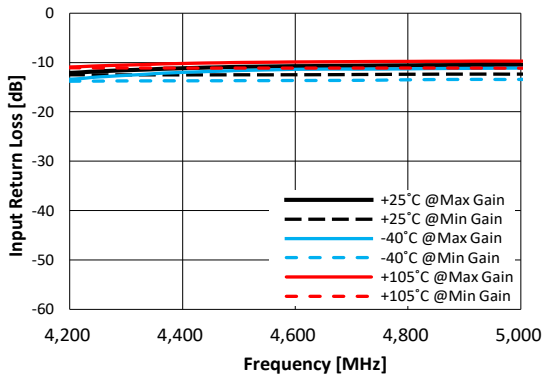
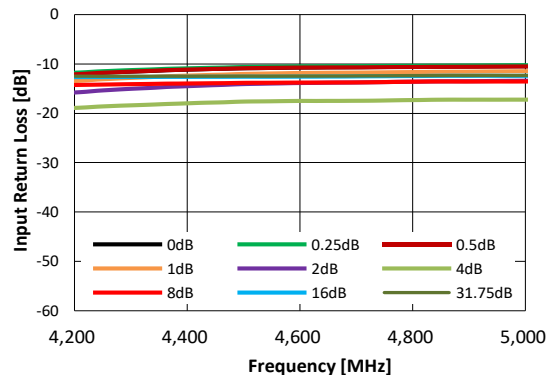


Figure 59. Gain vs. Frequency @ VDD = 4.0V over Temperature

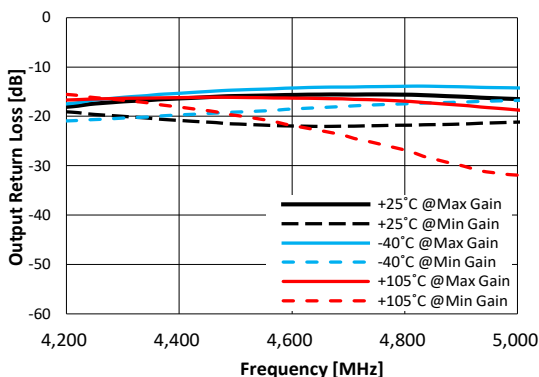
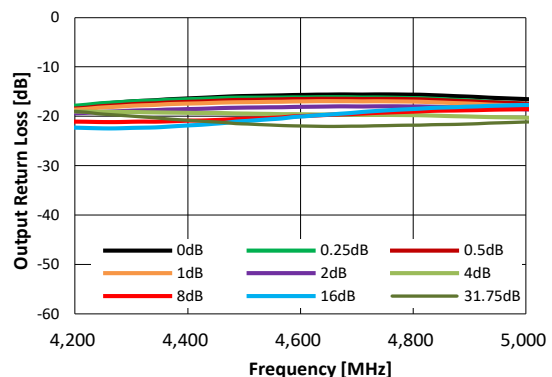


**Typical RF Performance Plot - BVA1762 EVK - PCB (Application Circuit:4.2 ~ 5.0GHz)**

Typical Performance Data @ 25°C and VDD = 5V unless otherwise noted and Application Circuit refer to Table 20

**Figure 60. Gain vs. Frequency over Major Attenuation States**

**Figure 61. Gain vs. Frequency vs VDD Max Gain States**

**Figure 62. Input Return Loss vs. Frequency over Temperature (Min<sup>1</sup> / Max Gain State)**

**Figure 63. Input Return Loss vs. Frequency Over Major Attenuation States**


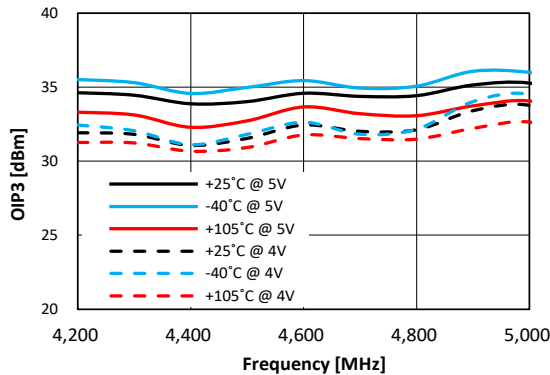
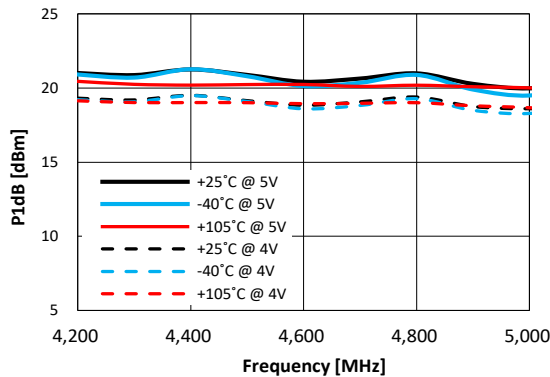
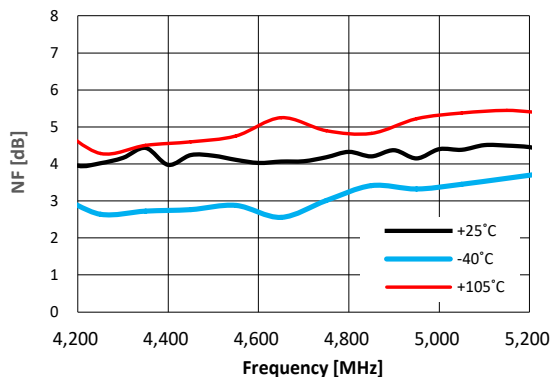
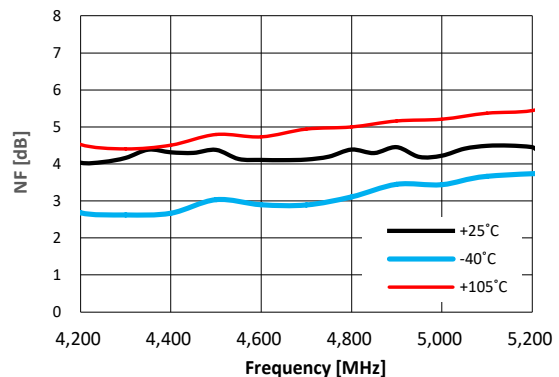
1. Min Gain was measured in the state is set with attenuation 31.75dB.

**Figure 64. Output Return Loss vs. Frequency over Temperature (Min<sup>1</sup> / Max Gain State)**

**Figure 65. Output Return Loss vs. Frequency over Major Attenuation States**


1. Min Gain was measured in the state is set with attenuation 31.75dB.

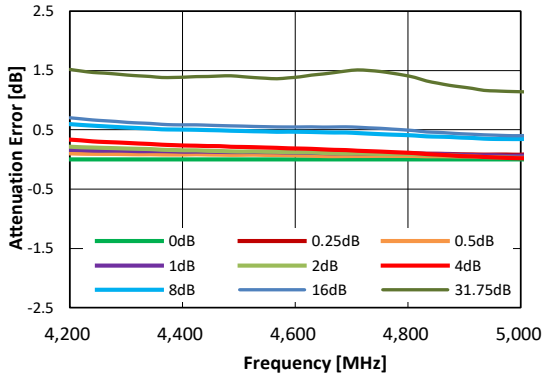
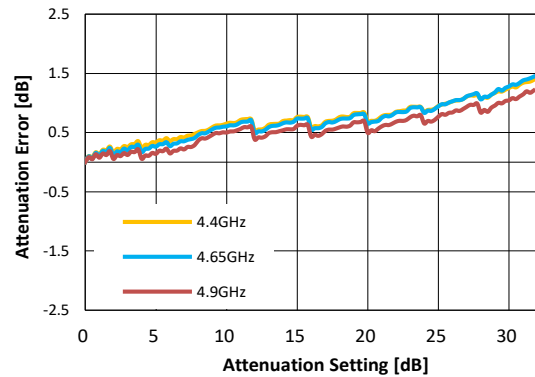
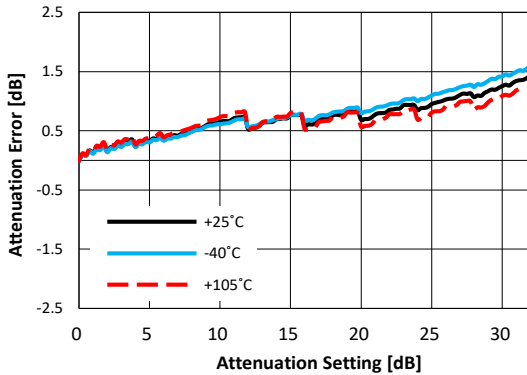
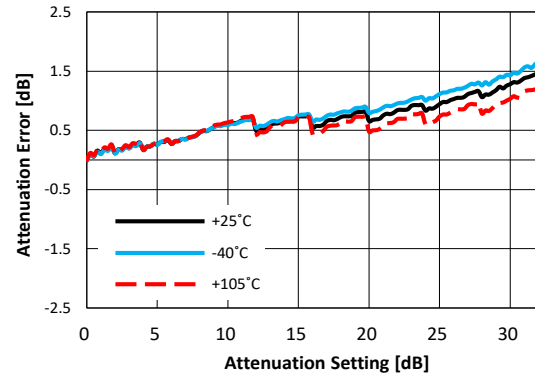
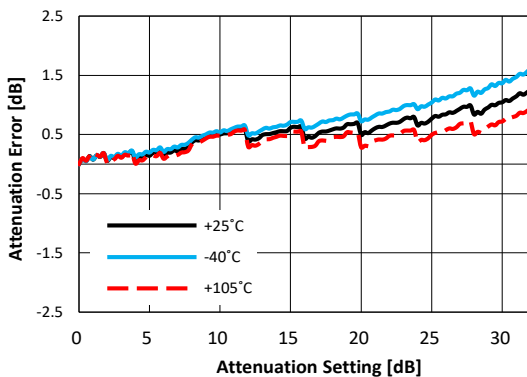
**Typical RF Performance Plot - BVA1762 EVK - PCB (Application Circuit:4.2 ~ 5.0GHz)**

Typical Performance Data @ 25°C and VDD = 5V unless otherwise noted and Application Circuit refer to Table 20

**Figure 66. OIP3 vs. Frequency vs. VDD**  
 Over Temperature (Max Gain State)

**Figure 67. P1dB vs. Frequency vs. VDD**  
 Over Temperature (Max Gain State)

**Figure 68. Noise Figure vs. Frequency @ VDD = 5V**  
 Over Temperature (Max Gain State)

**Figure 69. Noise Figure vs. Frequency @ VDD = 4.0V**  
 Over Temperature (Max Gain State)


**Typical RF Performance Plot - BVA1762 EVK - PCB (Application Circuit:4.2~ 5.0GHz)**

Typical Performance Data @ 25°C and VDD = 5V unless otherwise noted and Application Circuit refer to Table 20

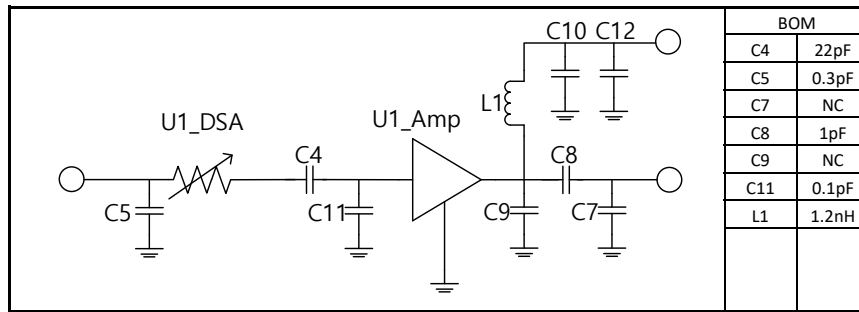
**Figure 70. Attenuation Error vs Frequency**  
 over Major Attenuation Steps

**Figure 71. Attenuation Error vs Attenuation Setting**  
 over Major Frequency (Max Gain State)

**Figure 72. Attenuation Error at 4.4GHz vs Temperature**  
 Over All Attenuation States

**Figure 73. Attenuation Error at 4.65GHz vs Temperature**  
 Over All Attenuation States

**Figure 74. Attenuation Error at 4.9GHz vs Temperature**  
 Over All Attenuation States




### Typical RF Performance Plot - BVA1762 EVK - PCB (Application Circuit:5.8 ~ 7.5GHz)

Typical Performance Data @ 25°C and VDD = 5V unless otherwise noted and Application Circuit refer to Table 23

Table 23. 5.8 ~ 7.5GHz RF Application Circuit



This value can be changed little by little according to the frequency band and bandwidth.

Table 24. Typical RF Performance @ VDD = 5V

Parameter	Frequency		Unit
	5800	7200	
Gain <sup>1</sup>	18.0	18.2	dB
S11	-9.4	-9.6	dB
S22	-25.8	-20.1	dB
OIP3 <sup>2</sup>	33.9	31.0	dBm
P1dB	18.8	16.5	dBm
Noise Figure	4.0	5.2	dB

- Gain data has PCB & Connectors insertion loss de-embedded
- OIP3\_ measured with two tones at an output of 3 dBm per tone separated by 1MHz.

Table 25. Typical RF Performance @ VDD = 4.0V

Parameter	Frequency		Unit
	5800	7200	
Gain <sup>1</sup>	16.9	16.9	dB
S11	-8.3	-8.3	dB
S22	-18.3	-15.0	dB
OIP3 <sup>2</sup>	31.7	28.0	dBm
P1dB	17.1	14.9	dBm
Noise Figure	4.1	5.3	dB

- Gain data has PCB & Connectors insertion loss de-embedded
- OIP3\_ measured with two tones at an output of 3 dBm per tone separated by 1MHz.

Figure 75. Gain vs. Frequency @ VDD = 5V over Temperature

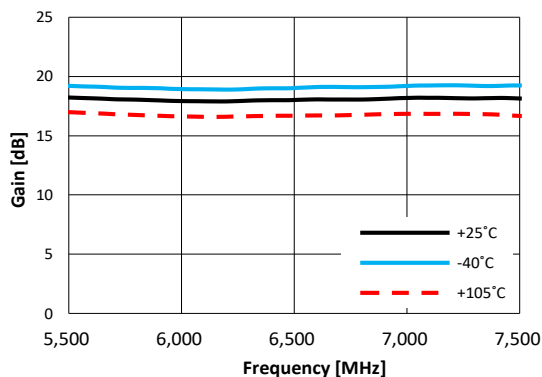
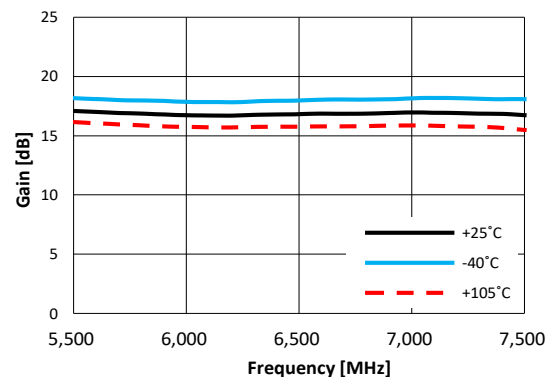
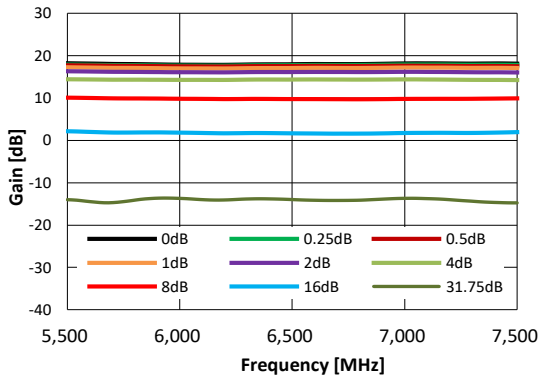
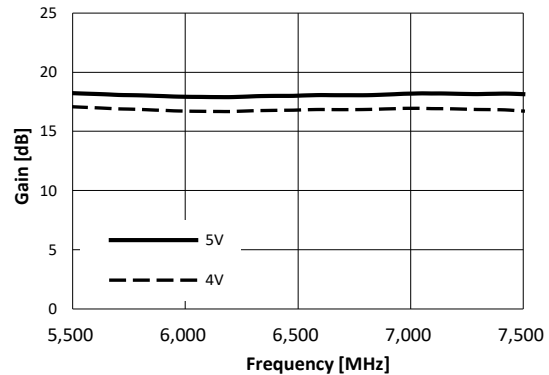
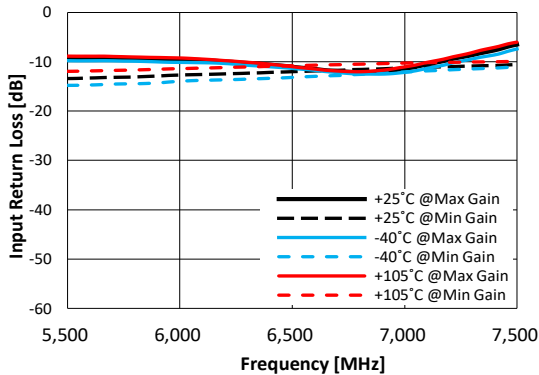


Figure 76. Gain vs. Frequency @ VDD = 4.0V over Temperature

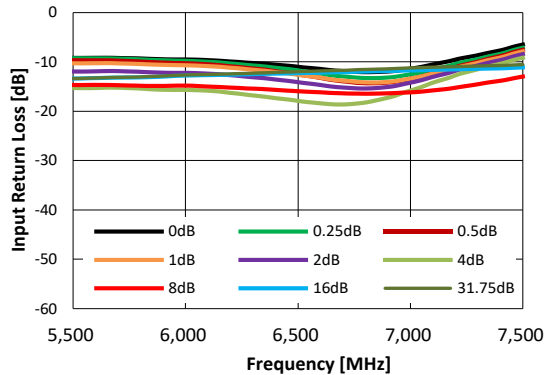
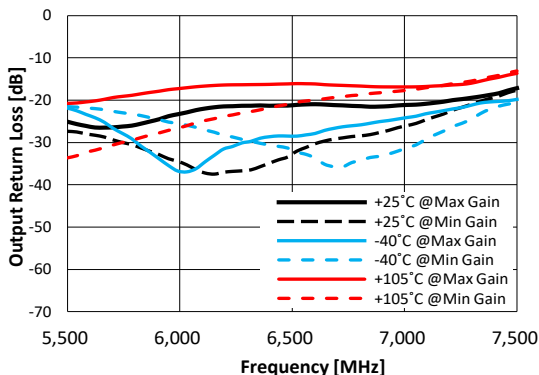


**Typical RF Performance Plot - BVA1762 EVK - PCB (Application Circuit:5.8 ~ 7.5GHz)**

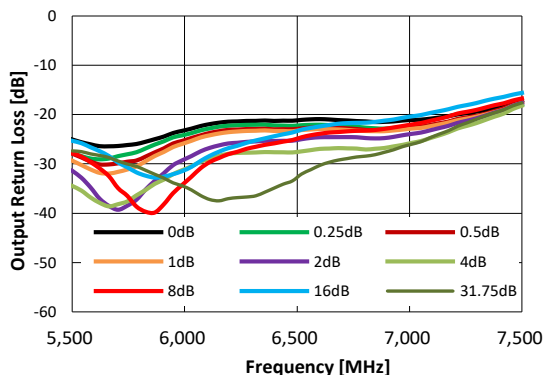
Typical Performance Data @ 25°C and VDD = 5V unless otherwise noted and Application Circuit refer to Table 23

**Figure 77. Gain vs. Frequency**  
 over Major Attenuation States

**Figure 78. Gain vs. Frequency vs VDD**  
 Max Gain States

**Figure 79. Input Return Loss vs. Frequency**  
 over Temperature (Min<sup>1</sup> / Max Gain State)


1.Min Gain was measured in the state is set with attenuation 31.75dB.

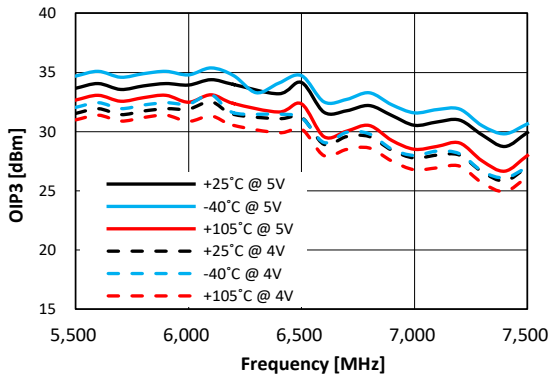
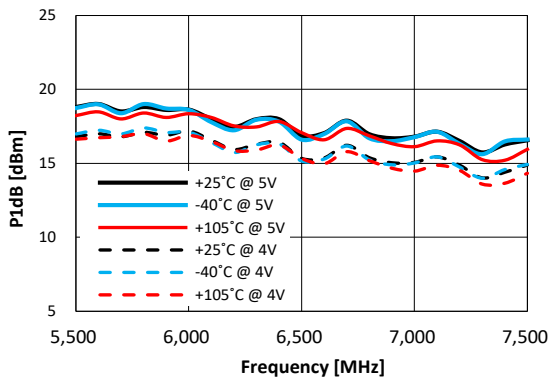
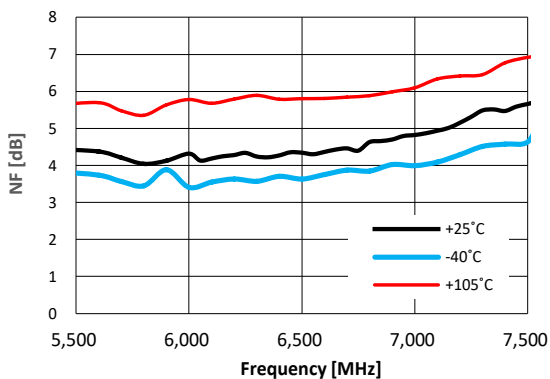
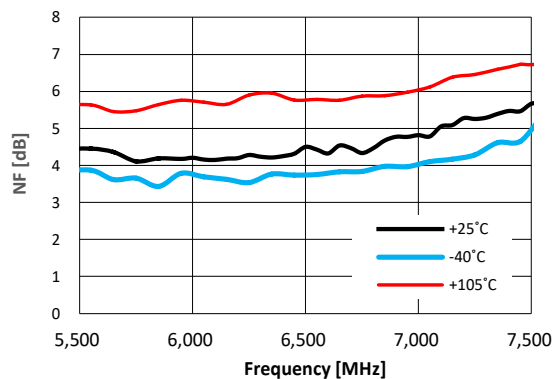
**Figure 80. Input Return Loss vs. Frequency**  
 Over Major Attenuation States

**Figure 81. Output Return Loss vs. Frequency**  
 over Temperature (Min<sup>1</sup> / Max Gain State)


1.Min Gain was measured in the state is set with attenuation 31.75dB.

**Figure 82. Output Return Loss vs. Frequency**  
 over Major Attenuation States


**Typical RF Performance Plot - BVA1762 EVK - PCB (Application Circuit:5.8 ~ 7.5GHz)**

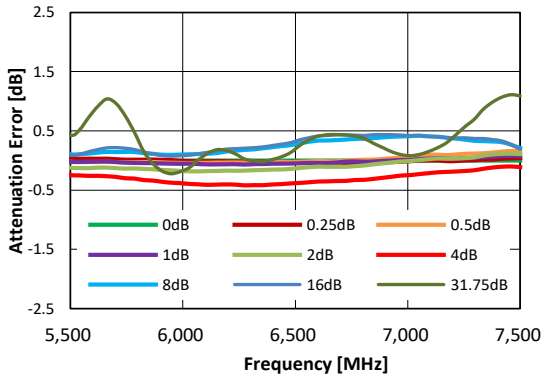
Typical Performance Data @ 25°C and VDD = 5V unless otherwise noted and Application Circuit refer to Table 23

**Figure 83. OIP3 vs. Frequency vs. VDD**  
 Over Temperature (Max Gain State)

**Figure 84. P1dB vs. Frequency vs. VDD**  
 Over Temperature (Max Gain State)

**Figure 85. Noise Figure vs. Frequency @ VDD = 5V**  
 Over Temperature (Max Gain State)

**Figure 86. Noise Figure vs. Frequency @ VDD = 4.0V**  
 Over Temperature (Max Gain State)


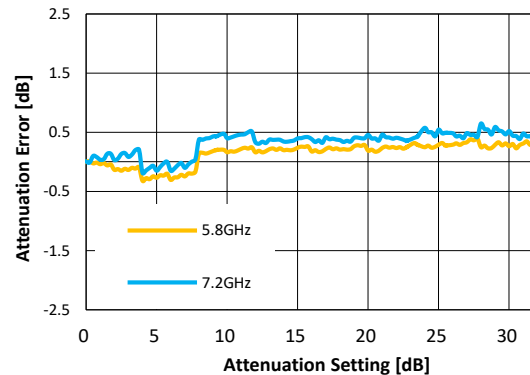
### Typical RF Performance Plot - BVA1762 EVK - PCB (Application Circuit:6.0 ~ 7.5GHz)

Typical Performance Data @ 25°C and VDD = 5V unless otherwise noted and Application Circuit refer to Table 23

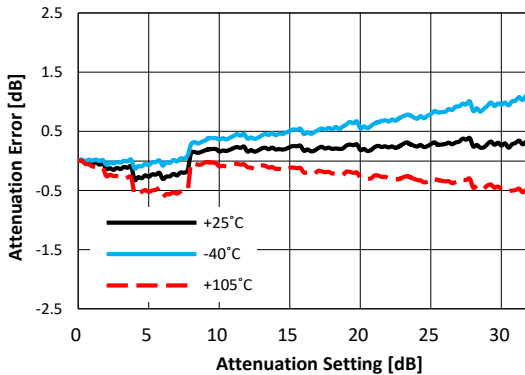
**Figure 87. Attenuation Error vs Frequency**  
over Major Attenuation Steps



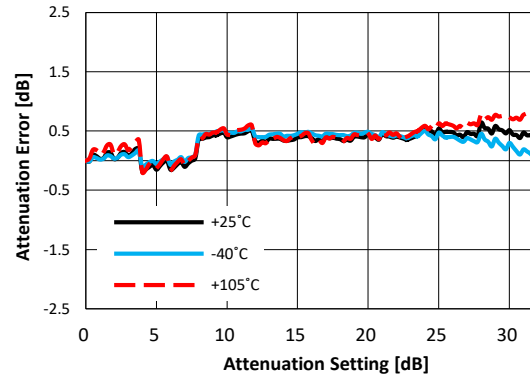
**Figure 88. Attenuation Error vs Attenuation Setting**  
over Major Frequency (Max Gain State)



**Figure 89. Attenuation Error at 5.8GHz vs Temperature**  
Over All Attenuation States



**Figure 90. Attenuation Error at 7.2GHz vs Temperature**  
Over All Attenuation States



1. Min Gain was measured in the state is set with attenuation 31.75dB.

Figure 91. Evaluation Board Schematic

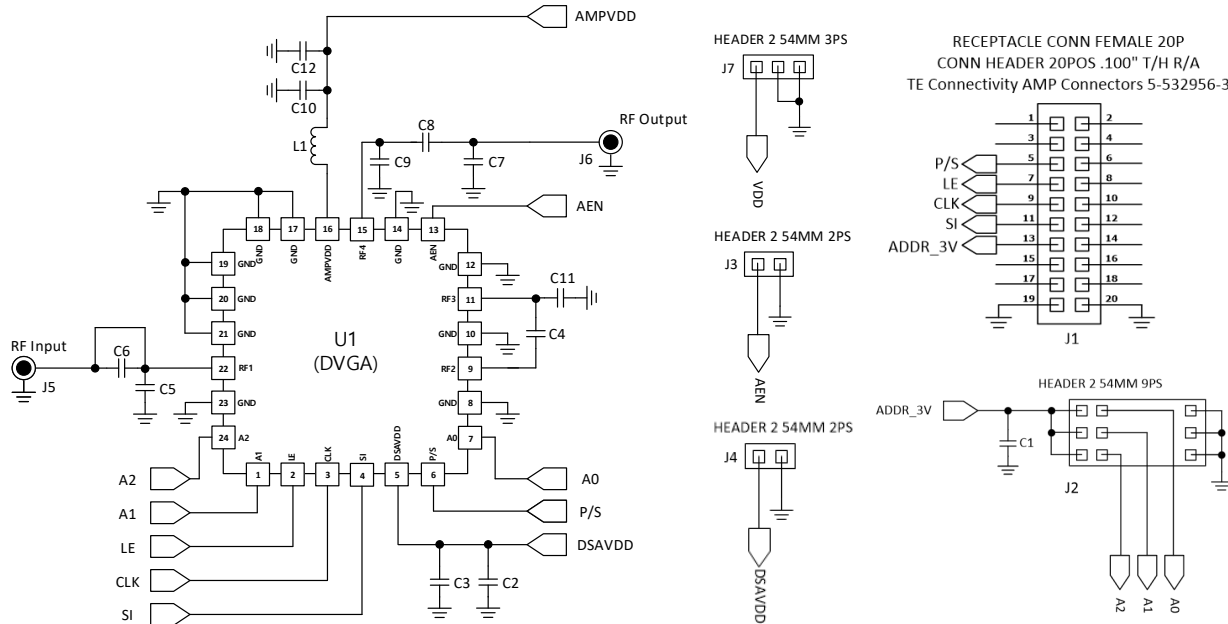


Figure 92. Evaluation Board PCB

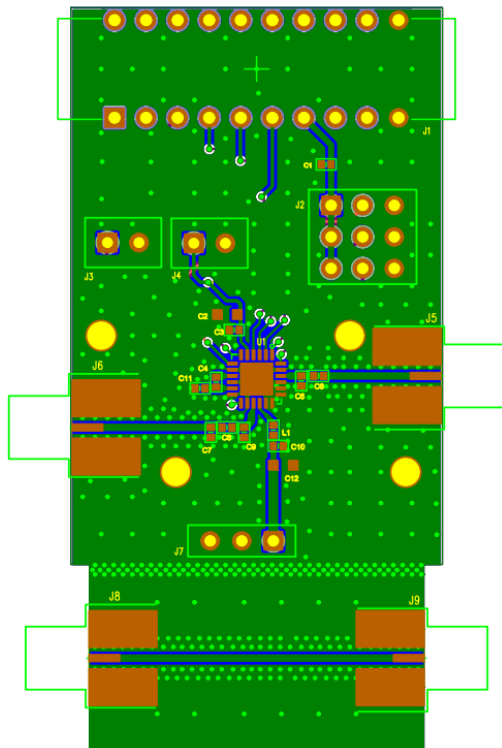


Table 26. Application Circuit

Application Circuit Values Example					
Frequency band	500MHz ~ 1.1GHz	1.7GHz ~ 2.7GHz	3.3GHz ~ 4.0GHz	4.2GHz ~ 5.0GHz	5.8GHz ~ 7.5GHz
L1	56nH	5.6nH	2.2nH	1.5nH	1.2nH
C4	100pF	22pF	22pF	22pF	22pF
C5	NC	NC	NC	0.3pF	0.3pF
C6	NC	NC	NC	NC	NC
C7	NC	NC	NC	NC	NC
C8	100pF	15pF	15pF	1.2pF	1pF
C9	NC	NC	NC	NC	NC
C11	NC	NC	NC	NC	0.1pF

Table 27. Bill of Material - Evaluation Board

No.	Ref Des	Qty	Part Number	REMARK
1	L1	2	IND 0402	Refer to Table 26
2	C1	1	CAP 0402 100nF	
3	C4, C8	2	CAP 0402	Refer to Table 26
4	C3, C10	2	CAP 0402 100pF	
5	C2, C12	2	CAP 0603 100nF	
6	C5, C6, C7, C9, C11	5	CAP 0402	Refer to Table 26
7	J1	1	20pin Receptacle connector	2.54mm, female
8	J2	1	3pin x 3 Header array	2.54mm, male
9	J3, J4	2	2pin Header	2.54mm, male
10	J5, J6, J8, J9	4	SMA_END_LAUNCH	RF SMA Connector
11	J7	1	3pin Header	2.54mm, male
12	U1	1	QFN4X4_24L_BVA1762	

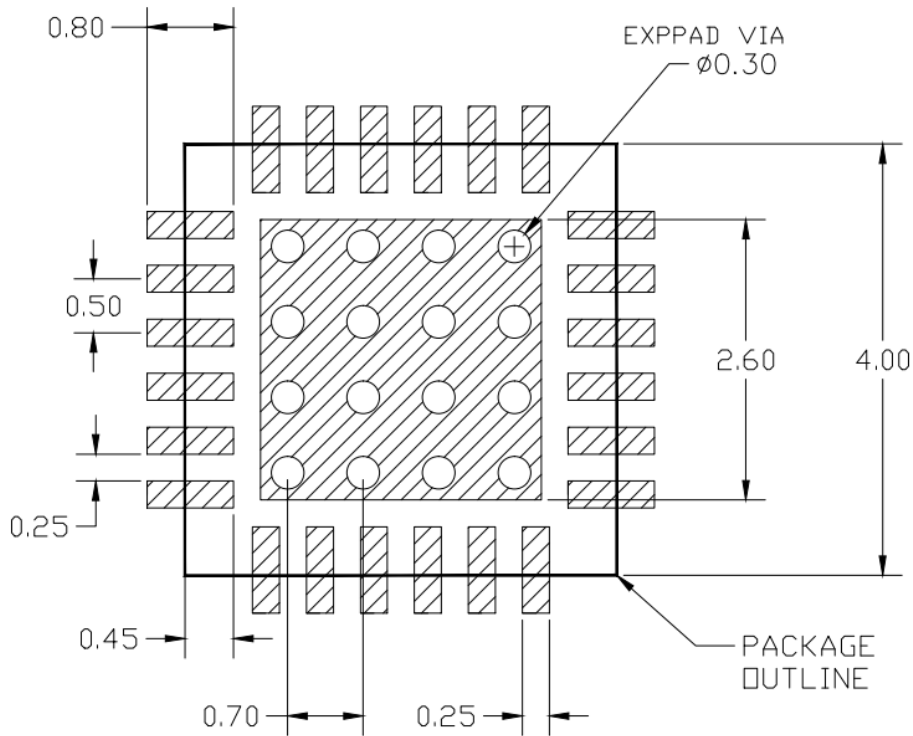
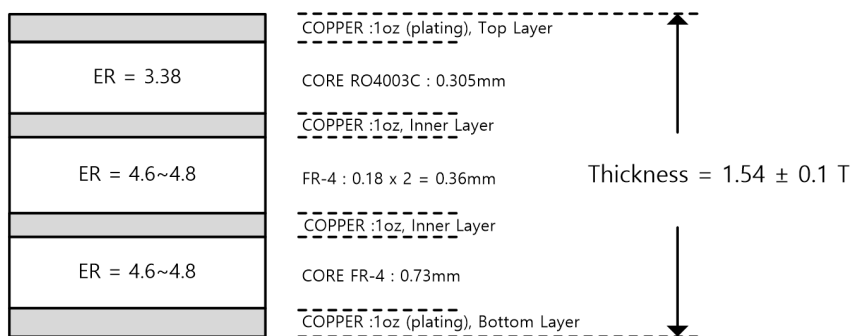
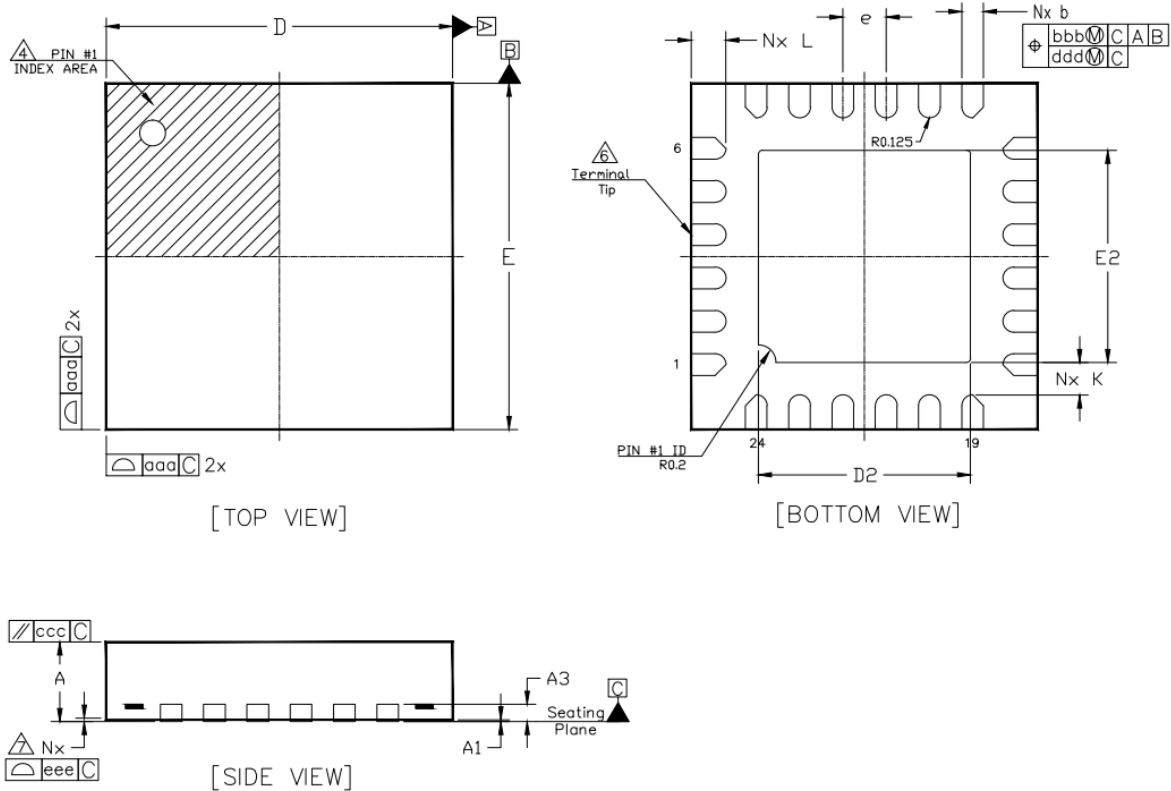
**Figure 93. Suggested PCB Land Pattern and PAD Layout**

**Figure 94. Evaluation Board PCB Layer Information**


Figure 95. Package Outline Dimension

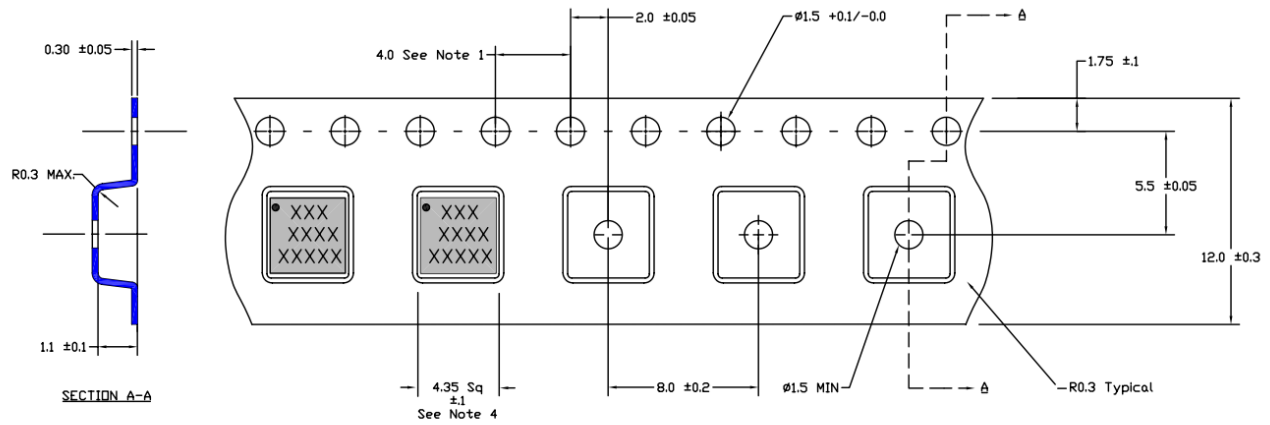


NOTES:

1. Dimensioning and tolerancing conform to ASME Y14.5–2009.
2. All dimensions are in millimeters.
3. N is the total number of terminals.
4. The location of the marked terminal #1 identifier is within the hatched area.
5. ND and NE refer to the number of terminals each D and E side respectively.
6. Dimension b applies to the metallized terminal and is measured between 0.15mm and 0.3mm from the terminal tip. If the terminal has a radius on the other end of it, dimension b should not be measured in that radius area.
7. Coplanarity applies to the terminals and all other bottom surface metallization.

Symbol	Thickness	Min	Nominal	Max	Note
A		0.80	0.90	1.00	
A1		0.00	0.02	0.05	
A3		---	0.20 Ref.	---	
b		0.15	0.25	0.30	6
D		4.00 BSC			
E		4.00 BSC			
e		0.50 BSC			
D2		2.30	2.45	2.55	
E2		2.30	2.45	2.55	
K		0.2	---	---	
L		0.30	0.40	0.50	
aaa		0.05			
bbb		0.10			
ccc		0.10			
ddd		0.05			
eee		0.08			
N		24			3
ND		6			5
NE		6			5

Figure 96. Tape & Reel



Packaging information:	
Tape Width	12mm
Reel Size	7"
Device Cavity Pitch	8mm
Devices Per Reel	1K

Figure 97. Package Marking



Marking information:	
BVA1762	Device Name
YY	Year
WW	Work Week
XX	Wafer Run Number



**Lead plating finish**

100% Tin Matte finish

(All BeRex products undergoes a 1 hour, 150 degree C, Anneal bake to eliminate thin whisker growth concerns.)

**MSL / ESD Rating**

<b>ESD Rating:</b>	Class 1C
<b>Value:</b>	±1000V
<b>Test:</b>	Human Body Model (HBM)
<b>Standard:</b>	JEDEC Standard JS-001-2017
<b>MSL Rating:</b>	<b>Level 1 at +260°C convection reflow</b>
<b>Standard:</b>	JEDEC Standard J-STD-020



Proper ESD procedures should be followed when handling this device.

**RoHS Compliance**

This part is compliant with Restrictions on the use of certain Hazardous Substances in Electrical and Electronic Equipment (RoHS) Directive 2011/65/EU as amended by Directive 2015/863/EU.

This product also is compliant with a concentration of the Substances of Very High Concern (SVHC) candidate list which are contained in a quantity of less than 0.1%(w/w) in each components of a product and/or its packaging placed on the European Community market by the BeRex and Suppliers.

**NATO CAGE code:**

<b>2</b>	<b>N</b>	<b>9</b>	<b>6</b>	<b>F</b>
----------	----------	----------	----------	----------