

User's Guide for WCSP-Packaged bq24261M 3-A Battery Charger Evaluation Module

The bq24261M evaluation module is a complete charger module for evaluating compact, flexible, high-efficiency, USB-friendly, switch-mode charge management solutions for single-cell, Li-ion and Li-polymer batteries used in a wide range of portable applications.

Contents

1	Introduction	2
	1.1 bq24261M IC Features.....	2
	1.2 bq24261M EVM Features	2
	1.3 Schematic.....	3
	1.4 I/O Description	4
	1.5 Test Points.....	4
	1.6 Control and Key Parameters Setting	5
	1.7 Recommended Operating Conditions	5
2	Test Summary.....	6
	2.1 Definitions.....	6
	2.2 Recommended Test Equipment	6
	2.3 Recommended Test Equipment Setup	8
	2.4 Recommended Test Procedure	10
3	Printed-Circuit Board Layout Guideline.....	12
4	Bill of Materials and Board Layout	13
	4.1 Bill of Materials	13
	4.2 Board Layout.....	14

List of Figures

1	bq24261MEVM Schematic	3
2	BAT_Load (PR1010) Schematic.....	7
3	Connections of HPA172 Kit	8
4	Original Test Setup for bq24261MEVM-691	9
5	Main Window of bq24261MSW Evaluation Software.....	10
6	Top Assembly Layer	14
7	Top Layer	15
8	First Internal Layer	16
9	Second Internal Layer	17
10	Bottom Layer.....	18
11	Bottom Assembly Drawing	19

List of Tables

1	Bill of Materials - bq24261MEVM-691	13
---	---	----

1 Introduction

1.1 **bq24261M IC Features**

The bq24261M device integrates a synchronous PWM controller, power MOSFETs, input-current sensing, high-accuracy current and voltage regulation, charge termination and power path management into a small WCSP package. The charge parameters can be programmed through an I²C interface. Key IC features include:

- High-efficiency, fully-integrated, NMOS-NMOS, synchronous buck charger with 1.5-MHz frequency
- Charge time optimizer
- Integrated power FETs for up to 3-A charge rate
- 5-V, 1-A OTG VBUS supply
- Power path management between battery and system voltages

For details, see the bq24261M data sheet ([SLUSC09](#)).

1.2 **bq24261M EVM Features**

The bq24261M evaluation module (EVM) on PCB PWR691 provide a complete charger module for evaluating compact, flexible, high-efficiency, USB-friendly, switch-mode battery charge and power path management solution for single-cell, Li-ion and Li-polymer battery-powered systems used in a wide range of portable applications. Key EVM features include:

- Terminal blocks and standard headers for IN, SYS, BAT, TS
- Programmable battery voltage, charge current, input current, and status via I²C interface
- IN operating up to 10.5 V for bq24261M
- LED indication for status signals
- Test points for key signals available for testing purposes. Easy probe hook-up

1.3 Schematic

Figure 1 illustrates the bq24261M schematic.

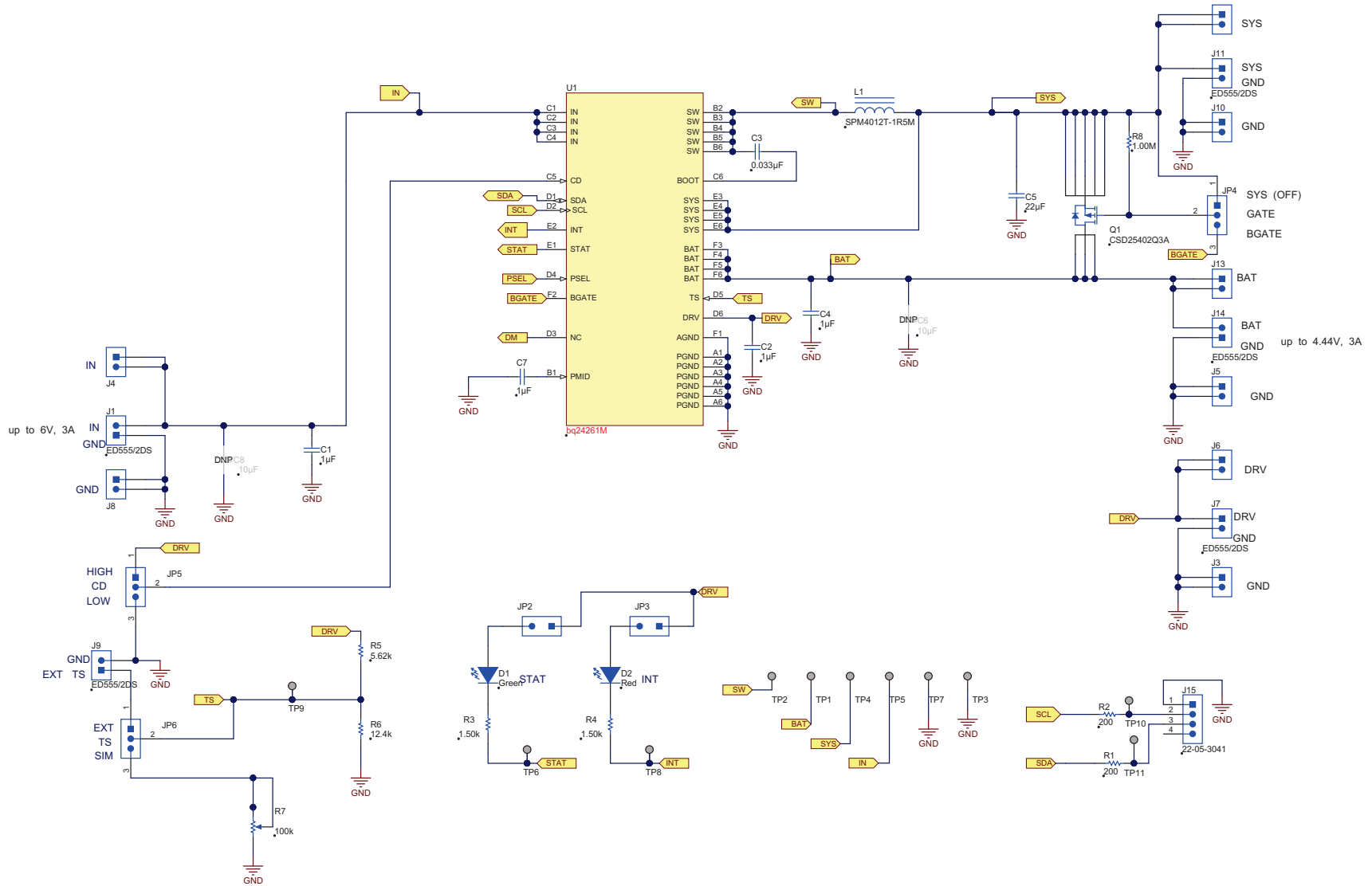

Figure 1. bq24261MEVM Schematic

1.4 I/O Description

Header/Terminal Block	Description
J1- IN/GND	Input power positive and negative terminal
J2 - Do not use	Do not use
J3 - GND	DRV linear regulator negative header
J4 - IN	Input power positive header
J5 - GND	Battery negative header
J6 - DRV	DRV linear regulator positive output
J7 - DRV/GND	DRV linear regulator positive and negative terminals
J8 - GND	Input power negative header
J9 - EXT TS/GND	External thermistor terminal
J10 - GND	SYS output negative header
J11 - SYS/GND	SYS output positive and negative terminal
J12 - SYS	SYS output positive header
J13 - BAT	Battery positive header
J14 - BAT/GND	Battery positive and negative header
J15 - USB-to-GPIO	USB-to-GPIO box keyed connector

1.5 Test Points

Test Point	Description
TP1	BAT
TP2	SW
TP3	GND
TP4	SYS
TP5	IN
TP6	STAT
TP7	GND
TP8	INT
TP9	TS
TP10	SCL
TP11	SDA

1.6 Control and Key Parameters Setting

Jumper	Description	Default Factory Setting
JP1	Leave jumper open	OPEN
JP2	Shorting jumper to connect DRV to anode of D1 STAT LED	SHORTED
JP3	Shorting jumper to connect DRV to anode of D1 INT LED	SHORTED
JP4	GATE = SYS: External PFET's gate tied to SYS and therefore disabled. GATE = BGATE: External PFET's gate tied to BGATE pin and therefore controlled by IC.	GATE=BGATE
JP5	CD = LO: Charge disable low for normal operation CD = HI: Charge disable high to disable the buck converter and enter Hi-Z mode	CD = LO
JP6	TS = SIM: Connects a potentiometer to the TS pin so that the potentiometer can simulate a thermistor. The potentiometer has been preset per R5 and R6 so that the TS voltage is 0.5 x V (DRV). TS = EXT: Connects the TS pin to an external thermistor through J9. The resistor divider formed by R5 and R6 has been sized to accommodate a 10-kΩ thermistor. If a different thermistor is used, R5 and R6 must be resized.	TS=SIM
JP7	PSEL = LO: Input current limit is set to 1.5 A until changed by I2C. PSEL = HI: Input current limit is set to USB100 until changed by I2C.	PSEL = HI

1.7 Recommended Operating Conditions

		Min	Typ	Max	Unit
Supply voltage, V_{IN}	Input voltage from ac adapter	4.2		10.0	V
System voltage, V_{SYS}	Voltage output at SYS terminal ; depends on VBAT voltage and status of V_{INDPM}	3.4		VBATR EG+3%	V
Battery voltage, V_{BAT}	Voltage output at VBAT terminal (registers set via I2C communication)	1.9	4.2	4.44	V
Supply current, $I_{IN(MAX)}$	Maximum input current from ac adapter input (registers set via I2C communication)	0.1		2.5	A
Fast charge current, $I_{CHRG(MAX)}$	Battery charge current (registers set via I2C communication)	0.500		3.0	A
Operating junction temperature range, T_J		-40		125	°C

2 Test Summary

This procedure describes one test configuration of the bq24261MEVM-691 evaluation board for bench evaluation.

2.1 Definitions

The following naming conventions are followed.

VXXX :	External voltage supply name (VADP, VBT, VSBT)
LOADW:	External load name (LOAD1, LOAD2)
V(TPyyy):	Voltage at internal test point TPyyy. For example, V(TP12) means the voltage at TP12.
V(Jxx):	Voltage at header Jxx
V(TP(XXX)):	Voltage at test point XXX. For example, V(ACDET) means the voltage at the test point which is marked as ACDET.
V(XXX, YYY):	Voltage across point XXX and YYY.
I(JXX(YYY)):	Current going out from the YYY terminal of header XX.
Jxx(BBB):	Terminal or pin BBB of header xx.
JPx ON :	Internal jumper Jxx terminals are shorted.
JPx OFF:	Internal jumper Jxx terminals are open.
JPx (-YY-)	ON: Internal jumper Jxx adjacent terminals marked as YY are shorted.
Measure: → A,B	Check specified parameters A, B. If measured values are not within specified limits, the unit under test has failed.
Observe → A,B	Observe if A, B occur. If they do not occur, the unit under test has failed.

Assembly drawings have location for jumpers, test points, and individual components.

2.2 Recommended Test Equipment

2.2.1 Power Supplies

1. Power Supply #1 (PS #1) capable of supplying 6 V at 2 A is required.
2. If not using a battery as the load, then power supply #2 (PS #2) capable of supplying up to 5 V at 5 A is required to power the circuit shown in [Figure 2](#).

2.2.2 Load #1 Between BAT and GND

Testing with an actual battery is the best way to verify operation in the system. If a battery is not available, then a circuit similar to the one shown in [Figure 2](#) can simulate a battery when connected to a power supply.

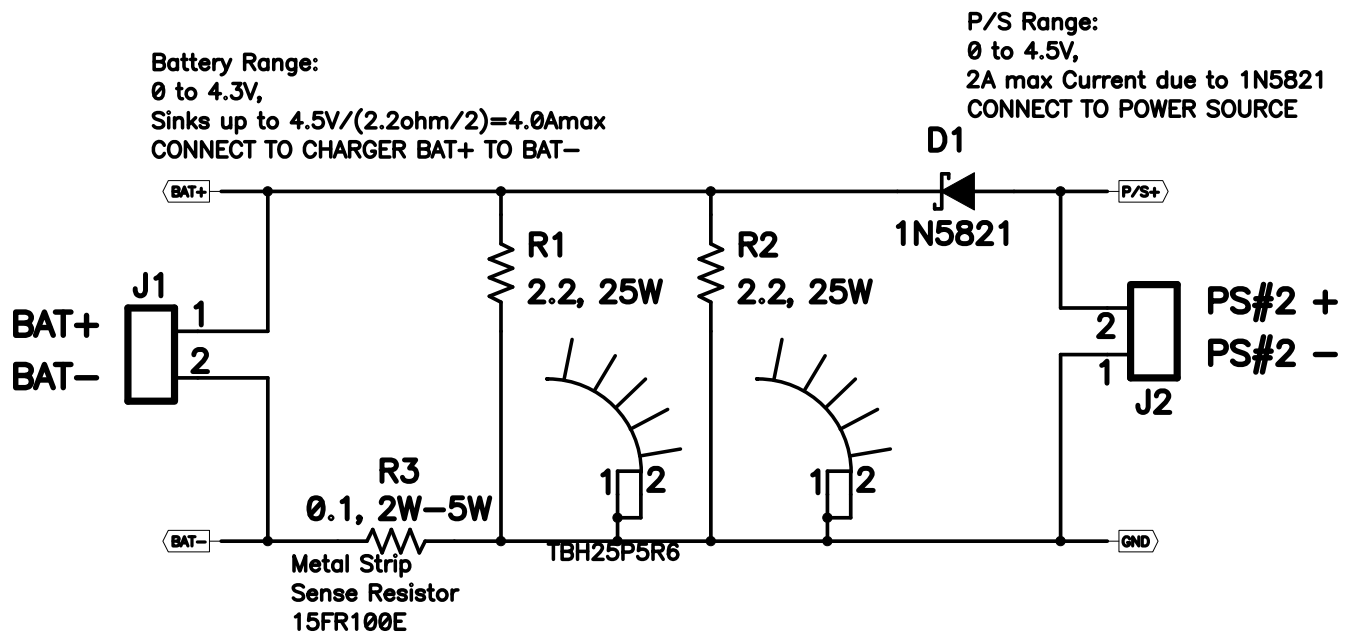

2.2.3 Load #2 Between SYS and GND

Although not required, a resistive load capable of sinking up to 3 A can be used.

2.2.4 Meters

Four equivalent voltage meters (VM #) and two equivalent current meters (CM #) are required. The current meters must be able to measure 2-A current.

2.2.5 Computer

A computer with at least one USB port and a USB cable is required. The bq24261M evaluation software must be properly installed.

2.2.6 HPA172 Communication Kit (USB TO GPIO)

An HPA172 USB-to-I²C communication kit is required.

2.2.7 Software

Download *Battery Management Studio.zip* from the charger's product folder, unzip the file, and double-click on the SETUP.EXE file. Follow the installation steps.

Because the bq24261M has the watchdog timers enabled, it is recommended that you set the software's **Reset Watchdog Timer** to reset every 5 seconds. Otherwise, after 30 seconds of operation, the IC enters Default mode. Note that the 27-minute safety timer is not reset by this function and eventually times out if charging does not complete, unless the **Safety Timer Time Limit** is expanded or disabled via the GUI. One way to reset the safety timer is to allow the 30-second watchdog timer to expire. See Figure 3 in the data sheet for more information about the timers.

Also, it is generally helpful to activate the **Write On Change** functions, in the upper left of the GUI window, to ON. The Write On Change function writes any changes to the GUI's check boxes, drop-down boxes, and registers to the IC. Otherwise, the user must click the **WRITE** button to write changes to the software. It is recommended that the user periodically click the **READ** button to find the IC's instantaneous status. Alternatively, the **AutoRead** function can be activated to periodically update the GUI with the IC's status.

2.3 Recommended Test Equipment Setup

1. For all power connections, use short, twisted-pair wires of appropriate gauge wire for the amount of the current.
2. Set power supply #1 (PS #1) for 6-V, 2-A current limit and then turn off supply.
3. If BAT_Load as shown in [Figure 1](#) is used, connect Power Supply #2 (PS #2) set to approximately 3.6 V to the input side (PS #2+/-) of BAT_Load, then turn off PS #2.
4. Connect the output side of the battery or BAT_Load in series with current meter (multimeter) #2 (CM #2) to J2 and J6 or J3 (BAT, GND). Ensure that a voltage meter is connected across J2 or TP3 and J6 or TP9 (BAT, GND).
5. Connect VM #3 across J10 or TP7 and J14 or TP9 (SYS, GND).
6. Connect VM #4 across J15 or TP5 and J14 or TP9 (DRV, GND).
7. Connect J17 to EV2400 kit by the 4-pin ribbon cable. Connect the USB port of the EV2400 kit to the USB port of the computer. The connections are shown in [Figure 3](#).

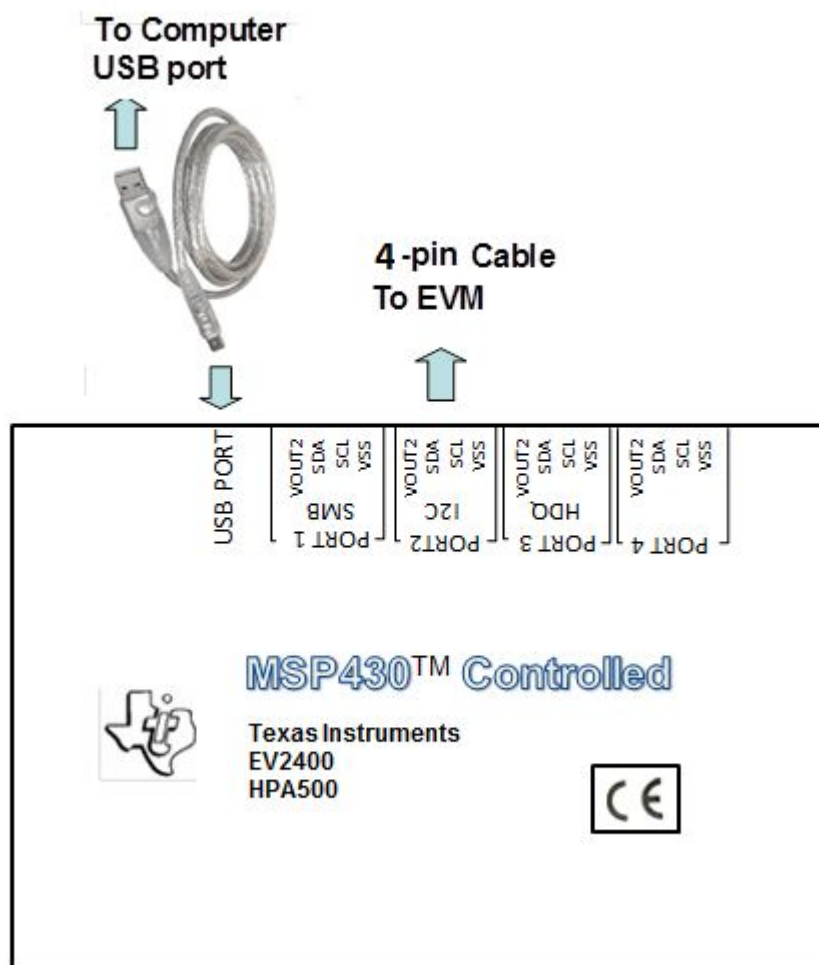

Figure 3. Connections of HPA172 Kit

8. Ensure jumpers are at the default factory settings per [Section 1.6](#).
9. After the preceding steps have been performed, the test setup for bq24261MEVM-691 is configured as is shown in [Figure 4](#).

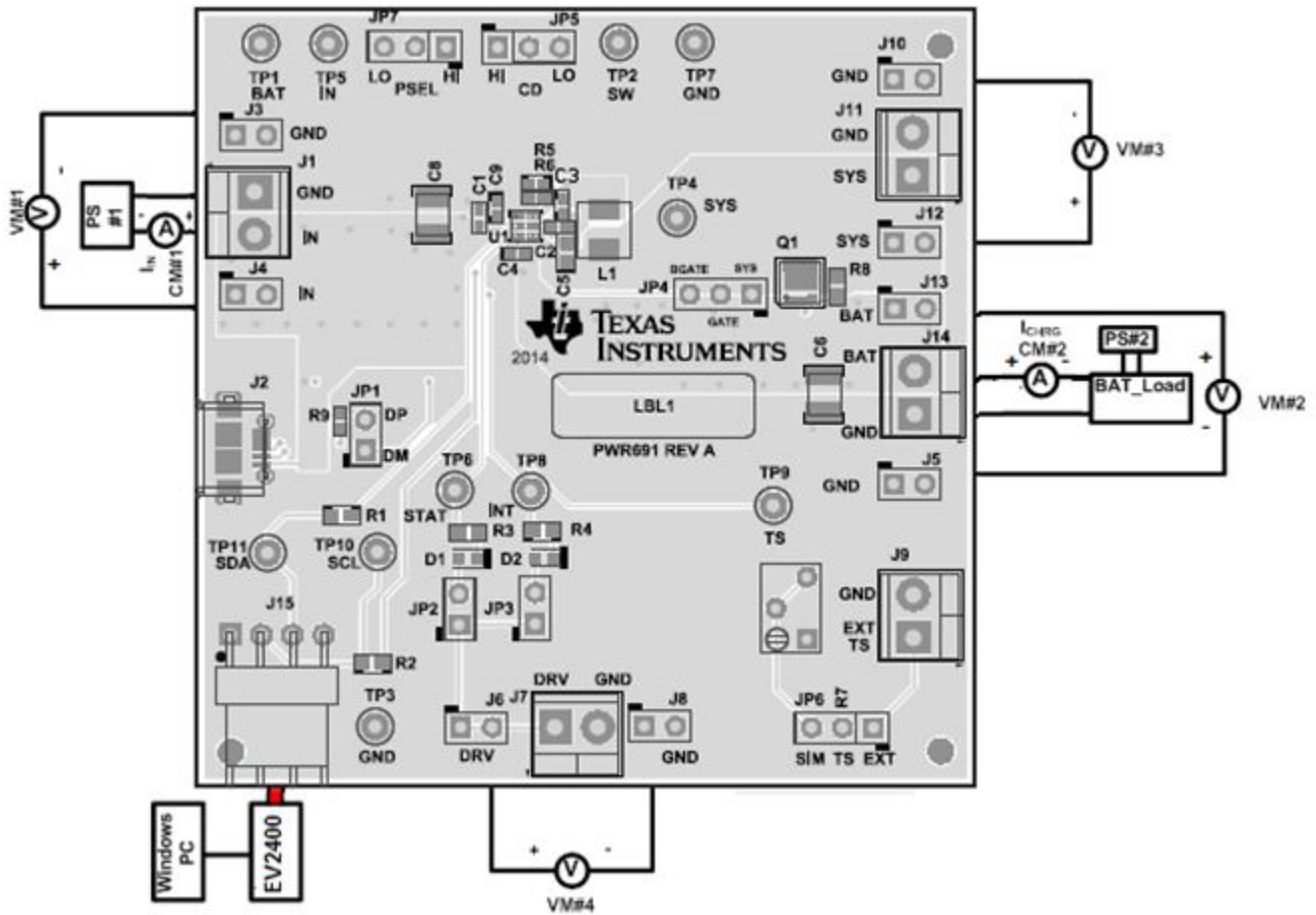

Figure 4. Original Test Setup for bq24261MEVM-691

10. Turn on the computer. Open the bq24261M evaluation software. The main window of the software is shown in [Figure 5](#).

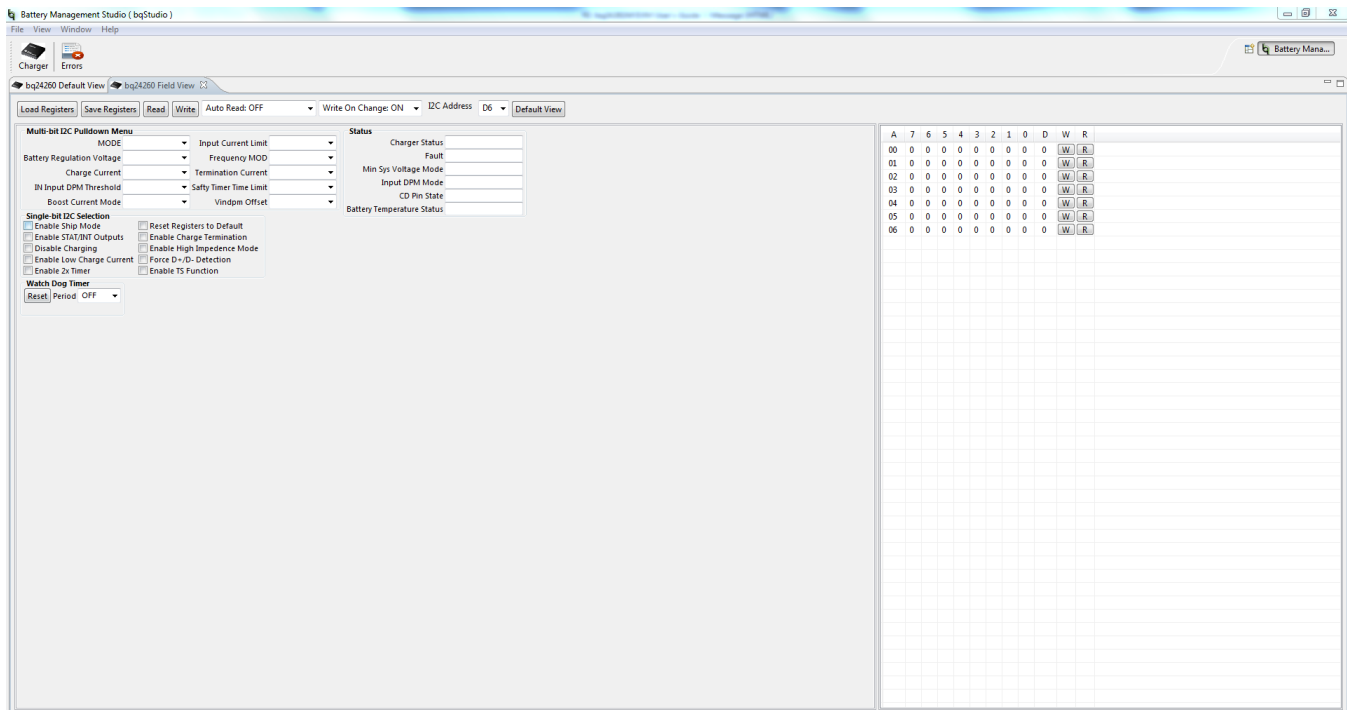

Figure 5. Main Window of bq24261MSW Evaluation Software

2.4 Recommended Test Procedure

The following test procedure may be useful for evaluating the charger IC outside of a real system, if no battery is available to connect to the output and a simulated battery if needed.

2.4.1 Charge Voltage and Current Regulation of IN in HOST mode

1. Ensure that the [Section 2.3](#) steps are followed.
2. Ensure that the shunts are installed as highlighted in yellow in [Figure 4](#).
3. Connect the output of Power Supply #1 (PS #1), with at least a 4-A current limit setting, in series with current meter (multimeter) #1 (CM #1) to J1 as shown in [Figure 4](#).
4. Connect voltage meter 1 (VM #1) across J4 and J3 or TP5 and or TP7 (IN, GND).
5. Connect either a real single cell lithium ion battery or battery simulator across J14 or J13/J5 (BAT, GND) with current meter #2 in series as shown in [Figure 4](#). If using a battery simulator like the one shown in [Figure 2](#) and referred to as BAT_LOAD in [Figure 4](#), configure power supply #2 (PS#2) with at least 4-A current limit for 3.4 V.
6. Install voltage meter #1 (VM #1) across J4 and J3 or TP5 and TP7 (IN and GND).
7. Install voltage meter #2 (VM #2) across J13 and J5 or TP1 and TP7 (BAT and GND).
8. Install voltage meter #3 (VM #3) across J12 and J10 or TP4 and TP7 (SYS and GND).
9. Voltage meter #4 is optional.
10. Turn on PS #1 and PS #2 if used.
11. Software setup:
 - Press the **READ** button to obtain the current settings.
 - Set **Write On Change** to ON if not already set.
 - Set **Reset Watchdog Timer** to reset every 5 seconds.
 - Uncheck **Disable Charging** if checked.
 - Check **Enable STAT/INT Outputs**.

- Set **Battery Regulation Voltage** to 4.20 V.
 - Set **Input Current Limit** to 2.5 A.
 - Set **Charge Current** to 2000 mA.
 - Click the **READ** button at the top of the window and confirm that the previous settings remain.
12. To test charge current regulation, adjust the PS #1 power supply so that VM #1 still reads 5 V and PS#2 so that the voltage measured by VM#2 is 3.6 V.
- Measure on CM#2* → $I_{\text{CHRG}} = 2000 \text{ mA} \pm 100 \text{ mA}$
- Measure on CM#1* → $I_{\text{IN}} < 1600 \text{ mA}$.
13. To test input current limit, lower the software's **Input Current Limit** setting to 900 mA then readjust PS #1 so that VM #1 reads 5 V and PS#2 reads 3.6 V.
- Measure on CM#2* → $I_{\text{CHRG}} < 2000 \text{ mA}$.
- Measure on CM#1* → $I_{\text{IN}} = 800 \text{ mA} - 900 \text{ mA}$.
14. To test minimum system voltage and DPPM, return the software's **Input Current Limit** setting to 2500 mA then lower PS #2 until VM#2 reads 3.3 V. Add an external resistive or constant current load across J13 and J5 that does not draw more than 2.5 A from SYS.
- Measure on VM#3* → 3.44 V – 3.55 V.
- Measure on CM#2* → $I_{\text{CHRG}} = 2000 \text{ mA} \pm 100 \text{ mA}$ minus the load current on SYS.
15. To test V_{INDPM} function, remove the load on SYS, adjust PS#1 so that VM#1 reads 5 V, adjust PS# 2 so that VM#2 reads 3.6 V and then lower the current limit setting on PS#1 to below the software's **Charge Current** setting.
- Measure on VM#1* → $V_{\text{IN}} = \text{software's } V_{\text{INDPM}} \text{ level (default of 4.2 V)}$.
- Measure on CM#2* → $I_{\text{CHRG}} < 2000 \text{ mA}$.
16. To test battery regulation and charge termination, return the PS#1 current limit to 4-A and confirm that the software's **Enable Termination** box is checked then slowly increase PS#2 until VM#2 reaches 4.2 V.
- Measure on CM#2* → I_{CHRG} slowly tapers to the software's I_{TERM} setting (default of 150 mA) and then drops to zero.
- Observe* → LEDs turn off.
17. To test battery supplement mode, lower PS #2 until VM#2 reads 3.6 V. Add an external resistive or constant current load across J13 and J5 that draws more than 2 A from SYS.
- Measure on VM#4* → $3.6 \text{ V} - I_{\text{BATSUP}} \times R_{\text{DSON(BATFET)}}$
- Measure on #2* → $I_{\text{CHRG}} = - I_{\text{BATSUP}}$
18. Turn off PS #1 and PS #2.

2.4.2 Helpful Hints

1. The leads/cables to the various power supplies have resistance. The current meters also have series resistance. Therefore, you must use voltmeters to measure the voltage as close to the IC pins as possible instead of relying on the supplies digital readouts.
2. When using a sourcemeter that can source and sink current as your battery simulator, it is highly recommended to add a large (1000 $\mu\text{F}+$) capacitor at the EVM BAT and GND connectors in order to prevent oscillations at the BAT pin due to mismatched impedances of the charger output and sourcemeter input within their respective regulation loop bandwidths. Configuring the sourcemeter for 4-wire sensing eliminates the need for a separate voltmeter to measure the voltage at the BAT pin. When using 4-wire sensing, always ensure that the sensing leads are connected first in order to prevent accidental overvoltage by the power leads.
3. For precise measurements of charge current and battery regulation near termination, the current meter in series with the battery or battery simulator must be removed. An alternate method for measuring charge current is to either use an oscilloscope with hall effect current probe or place a 1% or better, thermally capable (for example, 0.010 Ω in 1206 or larger footprint) resistor in series between the BAT pin and battery and measure the voltage across that resistor.

3 Printed-Circuit Board Layout Guideline

1. To obtain optimal performance, the power input capacitors, connected from the PMID input to PGND, must be placed as close as possible to the IC.
2. Place 4.7- μ F input capacitor as close to PMID pin and PGND pin as possible to make the high-frequency current loop area as small as possible. Place 1- μ F input capacitor GNDs as close to the respective PMID capacitor GND and PGND pins as possible to minimize the ground difference between the input and PMID.
3. The local bypass capacitor from SYS to GND must be connected between the SYS pin and PGND of the IC. The intent is to minimize the current path loop area from the SW pin through the LC filter and back to the PGND pin.
4. Place all decoupling capacitors close to their respective IC pins and as close as to PGND (do not place components such that routing interrupts power stage currents). All small control signals must be routed away from the high-current paths.
5. The PCB must have a ground plane (return) connected directly to the return of all components through vias (two vias per capacitor for power-stage capacitors, one via per capacitor for small-signal components). It is also recommended to put vias inside the PGND pads for the IC, if possible. A star ground design approach is typically used to keep circuit block currents isolated (high-power/low-power small-signal) which reduces noise-coupling and ground-bounce issues. A single ground plane for this design gives good results. With this small layout and a single ground plane, no ground-bounce issue exists, and having the components segregated minimizes coupling between signals.
6. The high-current charge paths into IN, USB, BAT, SYS, and from the SW pins must be sized appropriately for the maximum charge current in order to avoid voltage drops in these traces. The PGND pins must be connected to the ground plane to return current through the internal low-side FET.
7. For high-current applications, the balls for the power paths must be connected to as much copper in the board as possible. This allows better thermal performance because the board conducts heat away from the IC.

4 Bill of Materials and Board Layout

4.1 Bill of Materials

Table 1 lists the bill of materials for this EVM.

Table 1. Bill of Materials - bq24261MEVM-691

Designator	Description	Manufacturer	PartNumber	Qty
!PCB	Printed Circuit Board	Any	PWR691	1
C1	CAP, CERM, 4.7 μ F, 25 V, +/- 20%, X5R, 0402	MuRata	GRM155R61E475ME15	1
C2	CAP, CERM, 1 μ F, 10 V, +/- 10%, X7S, 0402	TDK	C1005X7S1A105K050BC	1
C3	CAP, CERM, 0.033 μ F, 25 V, +/- 10%, X7R, 0402	MuRata	GRM155R71E333KA88D	1
C4	CAP, CERM, 1 μ F, 10 V, +/- 10%, X5R, 0402	MuRata	GRM155R61A105KE15D	1
C5	CAP, CERM, 22 μ F, 10 V, +/- 20%, X5R, SMD, 2-Leads, Body 1.6x0.8mm	TDK	C1608X5R1A226M080AC	1
C9	CAP, CERM, 1 μ F, 25 V, +/- 10%, X5R, 0402	TDK	C1005X5R1E105K050BC	1
D1	LED, Green, SMD	Lite-On	LTST-C190GKT	1
D2	LED, Red, SMD	Lite-On	LTST-C190CKT	1
J1, J7, J9, J11, J14	Terminal Block, 6A, 3.5mm Pitch, 2-Pos, TH	On-Shore Technology	ED555/2DS	5
J2	Connector, Receptacle, Micro-USB Type AB, R/A, Bottom Mount SMT	Molex	0475890001	1
J3, J4, J5, J6, J8, J10, J12, J13, JP1, JP2, JP3	Header, 100mil, 2x1, TH	Mill-Max	800-10-002-10-001000	11
J15	Header (friction lock), 100mil, 4x1, R/A, TH	Molex	22-05-3041	1
JP4, JP5	Header, 100mil, 3x1, TH	Mill-Max	800-10-003-10-001000	2
L1	Inductor, Wirewound, Metal Composite, 1.5 μ H, 3.5 A, 0.07 ohm, SMD	TDK	SPM4012T-1R5M	1
LBL1	Thermal Transfer Printable Labels, 0.650" W x 0.200" H - 10,000 per roll	Brady	THT-14-423-10	1
Q1	MOSFET, P-CH, -20 V, -60 A, SON 3.3x3.3mm	Texas Instruments	CSD25401Q3	1
R1, R2	RES, 200 ohm, 1%, 0.1W, 0603	Vishay-Dale	CRCW0603200RFKEA	2
R3, R4	RES, 1.50k ohm, 1%, 0.1W, 0603	Yageo America	RC0603FR-071K5L	2
R5	RES, 5.62k ohm, 1%, 0.063W, 0402	Vishay-Dale	CRCW04025K62FKED	1
R6	RES, 12.4k ohm, 1%, 0.063W, 0402	Vishay-Dale	CRCW040212K4FKED	1
R7	Trimmer, 100k ohm, 0.25W, TH	Bourns	3266W-1-104LF	1
R8	RES, 1.00 M, 1%, 0.1 W, 0603	Vishay-Dale	CRCW06031M00FKEA	1
R9	RES, 0 ohm, 5%, 0.063W, 0402	Vishay-Dale	CRCW04020000Z0ED	1
SH-JP1, SH-JP2, SH-JP3, SH-JP4, SH-JP5	Shunt, 100mil, Gold plated, Black	3M	969102-0000-DA	5
TP1, TP5	Test Point, Miniature, Red, TH	Keystone	5000	2
TP2, TP4, TP6, TP8, TP9, TP10, TP11	Test Point, Miniature, White, TH	Keystone	5002	7
TP3, TP7	Test Point, Miniature, Black, TH	Keystone	5001	2
U1	3A, 30V, Host-Controlled Single-Input, Single Cell Switchmode Li-Ion Battery Charger with Power Path Management and USB-OTG Support, YFF0036ADAD	Texas Instruments	bq24261MYFF	1

4.2 Board Layout

Figure 6 through Figure 11 illustrate the PCB layouts for this EVM.

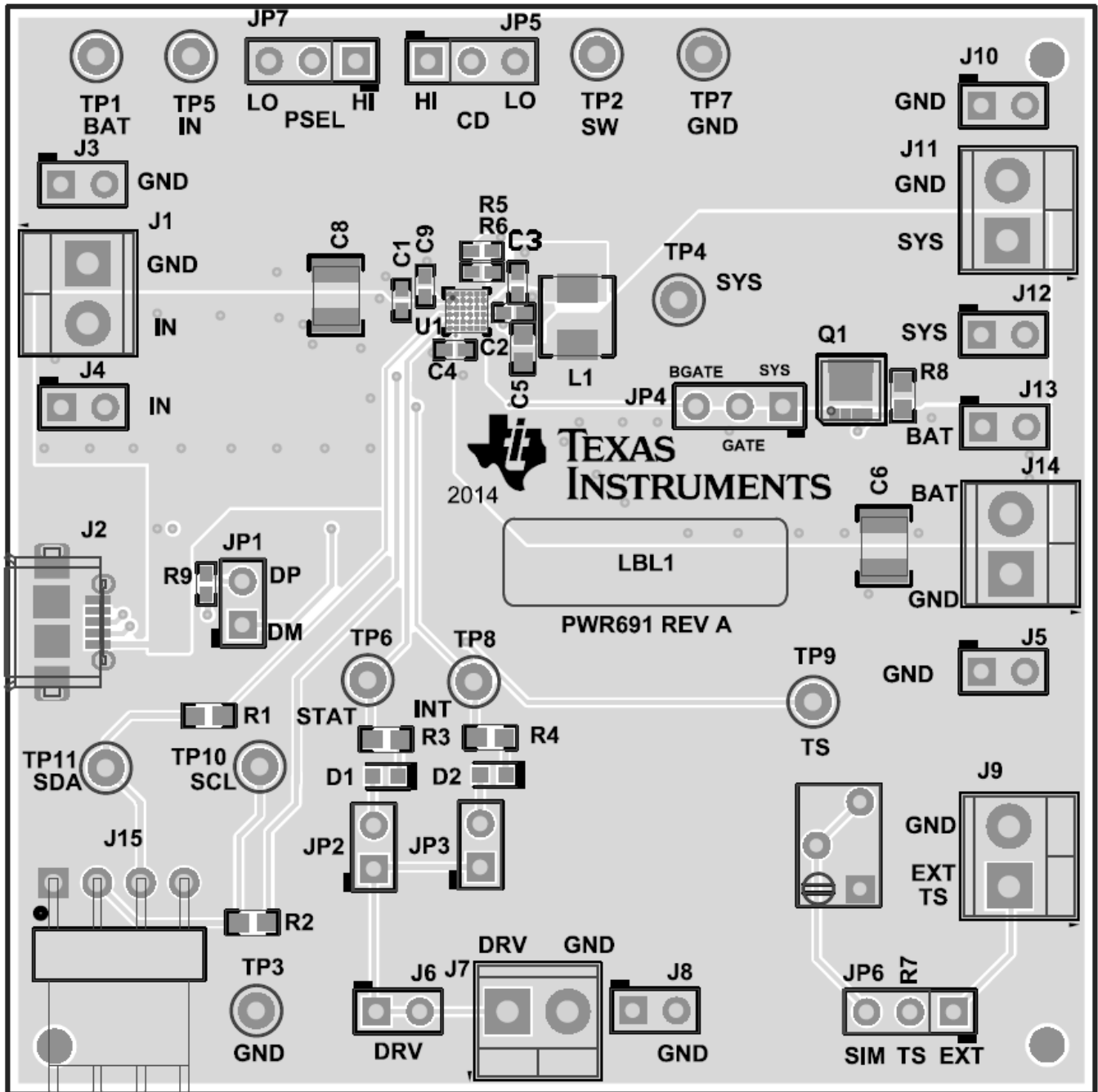

Figure 6. Top Assembly Layer

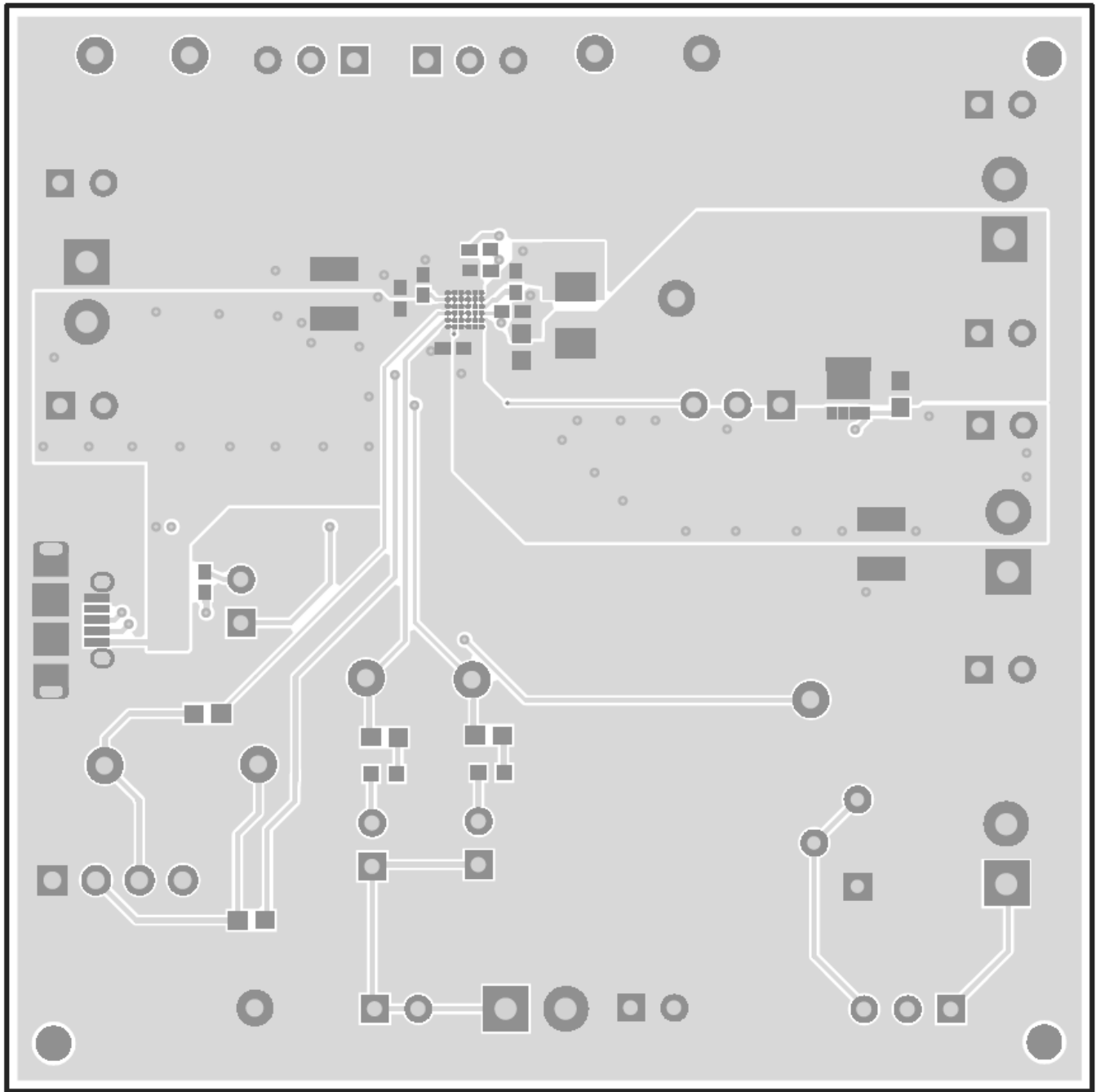

Figure 7. Top Layer

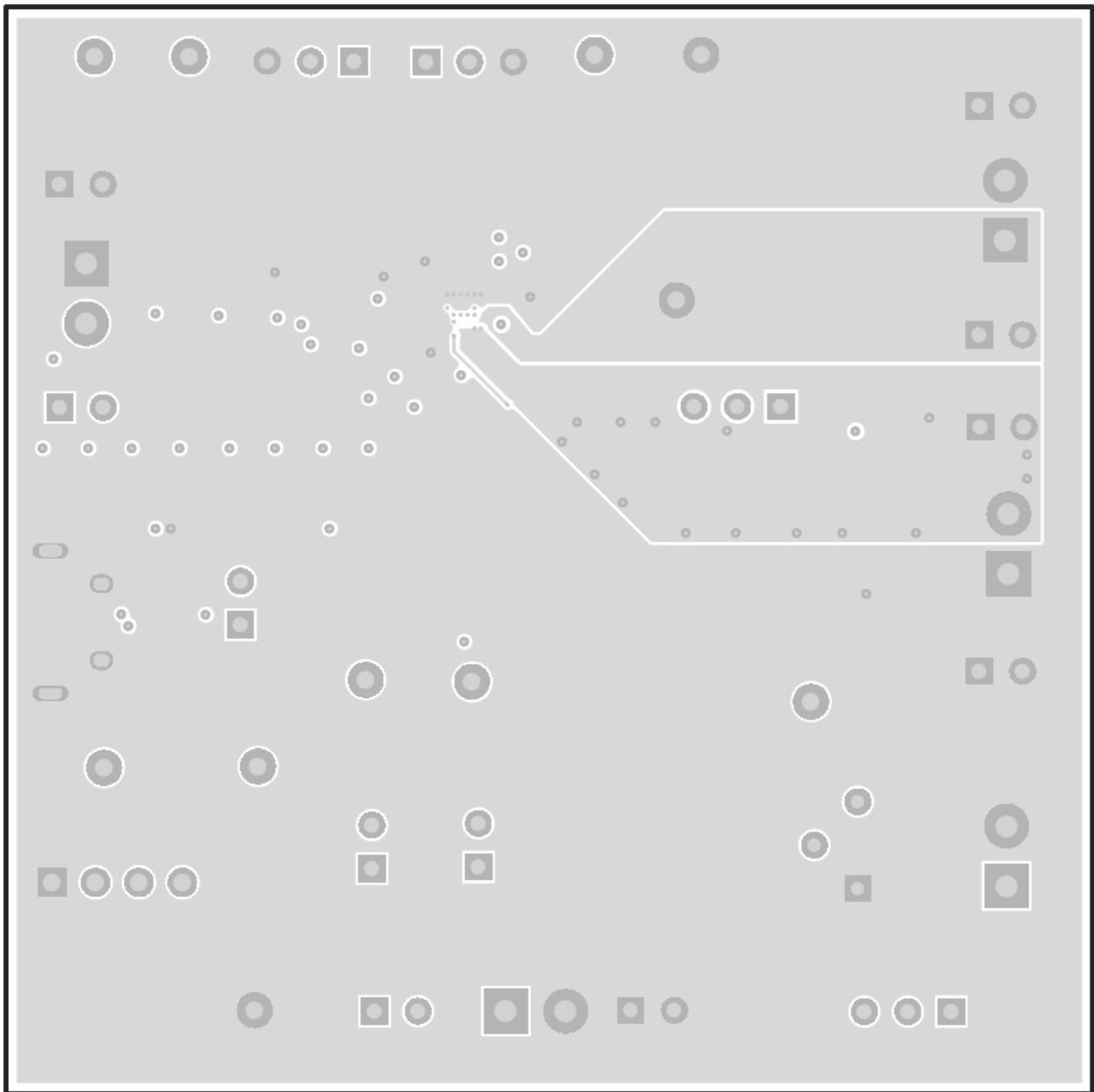

Figure 8. First Internal Layer

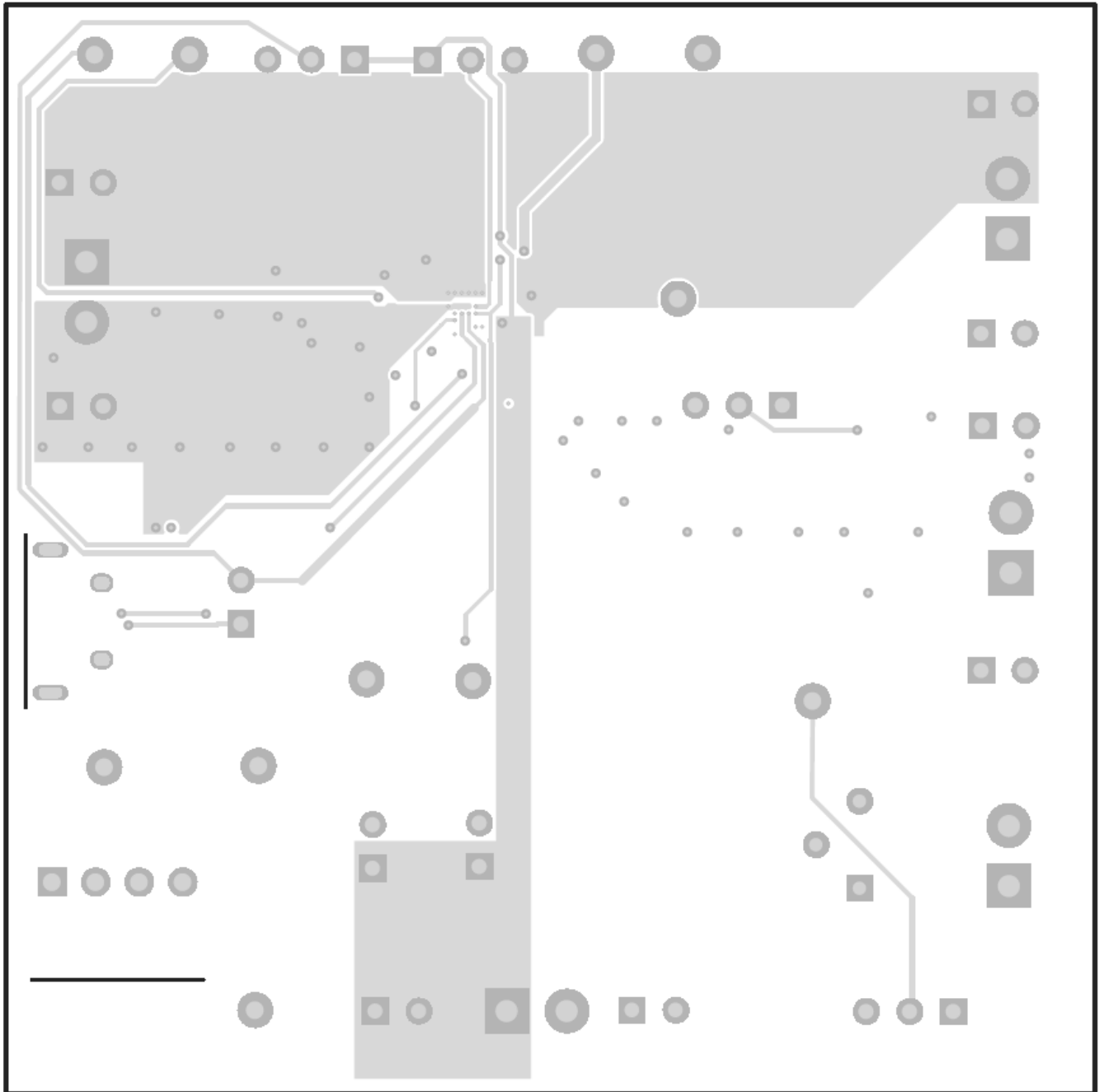

Figure 9. Second Internal Layer

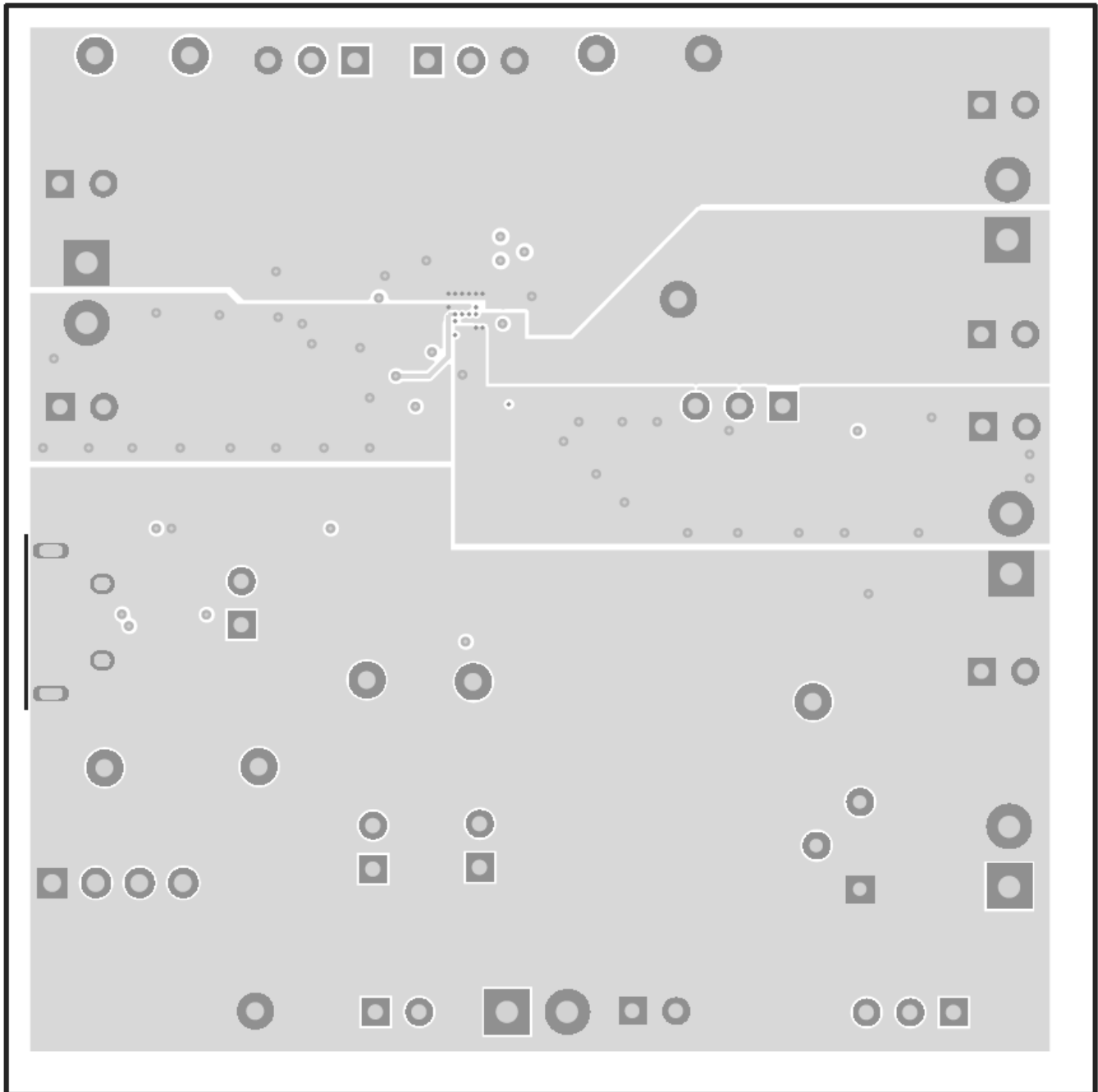

Figure 10. Bottom Layer



Figure 11. Bottom Assembly Drawing

Revision History

Changes from Original (April 2015) to A Revision	Page
• Deleted text "USB connector for IN" from bq24261M EVM Features	2
• Deleted the USB miniconnector from the schematic in Figure 1	3
• Changed J2 – USB To: J2 – Do not use in Section 1.4	4

NOTE: Page numbers for previous revisions may differ from page numbers in the current version.

STANDARD TERMS AND CONDITIONS FOR EVALUATION MODULES

1. *Delivery:* TI delivers TI evaluation boards, kits, or modules, including any accompanying demonstration software, components, or documentation (collectively, an "EVM" or "EVMs") to the User ("User") in accordance with the terms and conditions set forth herein. Acceptance of the EVM is expressly subject to the following terms and conditions.
 - 1.1 EVMs are intended solely for product or software developers for use in a research and development setting to facilitate feasibility evaluation, experimentation, or scientific analysis of TI semiconductor products. EVMs have no direct function and are not finished products. EVMs shall not be directly or indirectly assembled as a part or subassembly in any finished product. For clarification, any software or software tools provided with the EVM ("Software") shall not be subject to the terms and conditions set forth herein but rather shall be subject to the applicable terms and conditions that accompany such Software
 - 1.2 EVMs are not intended for consumer or household use. EVMs may not be sold, sublicensed, leased, rented, loaned, assigned, or otherwise distributed for commercial purposes by Users, in whole or in part, or used in any finished product or production system.
2. *Limited Warranty and Related Remedies/Disclaimers:*
 - 2.1 These terms and conditions do not apply to Software. The warranty, if any, for Software is covered in the applicable Software License Agreement.
 - 2.2 TI warrants that the TI EVM will conform to TI's published specifications for ninety (90) days after the date TI delivers such EVM to User. Notwithstanding the foregoing, TI shall not be liable for any defects that are caused by neglect, misuse or mistreatment by an entity other than TI, including improper installation or testing, or for any EVMs that have been altered or modified in any way by an entity other than TI. Moreover, TI shall not be liable for any defects that result from User's design, specifications or instructions for such EVMs. Testing and other quality control techniques are used to the extent TI deems necessary or as mandated by government requirements. TI does not test all parameters of each EVM.
 - 2.3 If any EVM fails to conform to the warranty set forth above, TI's sole liability shall be at its option to repair or replace such EVM, or credit User's account for such EVM. TI's liability under this warranty shall be limited to EVMs that are returned during the warranty period to the address designated by TI and that are determined by TI not to conform to such warranty. If TI elects to repair or replace such EVM, TI shall have a reasonable time to repair such EVM or provide replacements. Repaired EVMs shall be warranted for the remainder of the original warranty period. Replaced EVMs shall be warranted for a new full ninety (90) day warranty period.
3. *Regulatory Notices:*
 - 3.1 *United States*
 - 3.1.1 *Notice applicable to EVMs not FCC-Approved:*

This kit is designed to allow product developers to evaluate electronic components, circuitry, or software associated with the kit to determine whether to incorporate such items in a finished product and software developers to write software applications for use with the end product. This kit is not a finished product and when assembled may not be resold or otherwise marketed unless all required FCC equipment authorizations are first obtained. Operation is subject to the condition that this product not cause harmful interference to licensed radio stations and that this product accept harmful interference. Unless the assembled kit is designed to operate under part 15, part 18 or part 95 of this chapter, the operator of the kit must operate under the authority of an FCC license holder or must secure an experimental authorization under part 5 of this chapter.
 - 3.1.2 *For EVMs annotated as FCC – FEDERAL COMMUNICATIONS COMMISSION Part 15 Compliant:*

CAUTION

This device complies with part 15 of the FCC Rules. Operation is subject to the following two conditions: (1) This device may not cause harmful interference, and (2) this device must accept any interference received, including interference that may cause undesired operation.

Changes or modifications not expressly approved by the party responsible for compliance could void the user's authority to operate the equipment.

FCC Interference Statement for Class A EVM devices

NOTE: This equipment has been tested and found to comply with the limits for a Class A digital device, pursuant to part 15 of the FCC Rules. These limits are designed to provide reasonable protection against harmful interference when the equipment is operated in a commercial environment. This equipment generates, uses, and can radiate radio frequency energy and, if not installed and used in accordance with the instruction manual, may cause harmful interference to radio communications. Operation of this equipment in a residential area is likely to cause harmful interference in which case the user will be required to correct the interference at his own expense.

FCC Interference Statement for Class B EVM devices

NOTE: This equipment has been tested and found to comply with the limits for a Class B digital device, pursuant to part 15 of the FCC Rules. These limits are designed to provide reasonable protection against harmful interference in a residential installation. This equipment generates, uses and can radiate radio frequency energy and, if not installed and used in accordance with the instructions, may cause harmful interference to radio communications. However, there is no guarantee that interference will not occur in a particular installation. If this equipment does cause harmful interference to radio or television reception, which can be determined by turning the equipment off and on, the user is encouraged to try to correct the interference by one or more of the following measures:

- Reorient or relocate the receiving antenna.
- Increase the separation between the equipment and receiver.
- Connect the equipment into an outlet on a circuit different from that to which the receiver is connected.
- Consult the dealer or an experienced radio/TV technician for help.

3.2 Canada

3.2.1 For EVMs issued with an Industry Canada Certificate of Conformance to RSS-210

Concerning EVMs Including Radio Transmitters:

This device complies with Industry Canada license-exempt RSS standard(s). Operation is subject to the following two conditions: (1) this device may not cause interference, and (2) this device must accept any interference, including interference that may cause undesired operation of the device.

Concernant les EVMs avec appareils radio:

Le présent appareil est conforme aux CNR d'Industrie Canada applicables aux appareils radio exempts de licence. L'exploitation est autorisée aux deux conditions suivantes: (1) l'appareil ne doit pas produire de brouillage, et (2) l'utilisateur de l'appareil doit accepter tout brouillage radioélectrique subi, même si le brouillage est susceptible d'en compromettre le fonctionnement.

Concerning EVMs Including Detachable Antennas:

Under Industry Canada regulations, this radio transmitter may only operate using an antenna of a type and maximum (or lesser) gain approved for the transmitter by Industry Canada. To reduce potential radio interference to other users, the antenna type and its gain should be so chosen that the equivalent isotropically radiated power (e.i.r.p.) is not more than that necessary for successful communication. This radio transmitter has been approved by Industry Canada to operate with the antenna types listed in the user guide with the maximum permissible gain and required antenna impedance for each antenna type indicated. Antenna types not included in this list, having a gain greater than the maximum gain indicated for that type, are strictly prohibited for use with this device.

Concernant les EVMs avec antennes détachables

Conformément à la réglementation d'Industrie Canada, le présent émetteur radio peut fonctionner avec une antenne d'un type et d'un gain maximal (ou inférieur) approuvé pour l'émetteur par Industrie Canada. Dans le but de réduire les risques de brouillage radioélectrique à l'intention des autres utilisateurs, il faut choisir le type d'antenne et son gain de sorte que la puissance isotrope rayonnée équivalente (p.i.r.e.) ne dépasse pas l'intensité nécessaire à l'établissement d'une communication satisfaisante. Le présent émetteur radio a été approuvé par Industrie Canada pour fonctionner avec les types d'antenne énumérés dans le manuel d'usage et ayant un gain admissible maximal et l'impédance requise pour chaque type d'antenne. Les types d'antenne non inclus dans cette liste, ou dont le gain est supérieur au gain maximal indiqué, sont strictement interdits pour l'exploitation de l'émetteur.

3.3 Japan

3.3.1 *Notice for EVMs delivered in Japan:* Please see http://www.tij.co.jp/lstds/ti_ja/general/eStore/notice_01.page 日本国内に輸入される評価用キット、ボードについては、次のところをご覧ください。
http://www.tij.co.jp/lstds/ti_ja/general/eStore/notice_01.page

3.3.2 *Notice for Users of EVMs Considered "Radio Frequency Products" in Japan:* EVMs entering Japan may not be certified by TI as conforming to Technical Regulations of Radio Law of Japan.

If User uses EVMs in Japan, not certified to Technical Regulations of Radio Law of Japan, User is required by Radio Law of Japan to follow the instructions below with respect to EVMs:

1. Use EVMs in a shielded room or any other test facility as defined in the notification #173 issued by Ministry of Internal Affairs and Communications on March 28, 2006, based on Sub-section 1.1 of Article 6 of the Ministry's Rule for Enforcement of Radio Law of Japan,
2. Use EVMs only after User obtains the license of Test Radio Station as provided in Radio Law of Japan with respect to EVMs, or
3. Use of EVMs only after User obtains the Technical Regulations Conformity Certification as provided in Radio Law of Japan with respect to EVMs. Also, do not transfer EVMs, unless User gives the same notice above to the transferee. Please note that if User does not follow the instructions above, User will be subject to penalties of Radio Law of Japan.

【無線電波を送信する製品の開発キットをお使いになる際の注意事項】 開発キットの中には技術基準適合証明を受けていないものがあります。技術適合証明を受けていないものご使用に際しては、電波法遵守のため、以下のいずれかの措置を取っていただく必要がありますのでご注意ください。

1. 電波法施行規則第6条第1項第1号に基づく平成18年3月28日総務省告示第173号で定められた電波暗室等の試験設備でご使用いただく。
2. 実験局の免許を取得後ご使用いただく。
3. 技術基準適合証明を取得後ご使用いただく。

なお、本製品は、上記の「ご使用にあたっての注意」を譲渡先、移転先に通知しない限り、譲渡、移転できないものとします。

上記を遵守頂けない場合は、電波法の罰則が適用される可能性があることをご留意ください。日本テキサス・インスツルメンツ株式会社
東京都新宿区西新宿 6 丁目 2 4 番 1 号
西新宿三井ビル

3.3.3 *Notice for EVMs for Power Line Communication:* Please see http://www.tij.co.jp/llds/ti_ja/general/eStore/notice_02.page
電力線搬送波通信についての開発キットをお使いになる際の注意事項については、次のところをご覧ください。http://www.tij.co.jp/llds/ti_ja/general/eStore/notice_02.page

4 *EVM Use Restrictions and Warnings:*

4.1 EVMS ARE NOT FOR USE IN FUNCTIONAL SAFETY AND/OR SAFETY CRITICAL EVALUATIONS, INCLUDING BUT NOT LIMITED TO EVALUATIONS OF LIFE SUPPORT APPLICATIONS.

4.2 User must read and apply the user guide and other available documentation provided by TI regarding the EVM prior to handling or using the EVM, including without limitation any warning or restriction notices. The notices contain important safety information related to, for example, temperatures and voltages.

4.3 *Safety-Related Warnings and Restrictions:*

4.3.1 User shall operate the EVM within TI's recommended specifications and environmental considerations stated in the user guide, other available documentation provided by TI, and any other applicable requirements and employ reasonable and customary safeguards. Exceeding the specified performance ratings and specifications (including but not limited to input and output voltage, current, power, and environmental ranges) for the EVM may cause personal injury or death, or property damage. If there are questions concerning performance ratings and specifications, User should contact a TI field representative prior to connecting interface electronics including input power and intended loads. Any loads applied outside of the specified output range may also result in unintended and/or inaccurate operation and/or possible permanent damage to the EVM and/or interface electronics. Please consult the EVM user guide prior to connecting any load to the EVM output. If there is uncertainty as to the load specification, please contact a TI field representative. During normal operation, even with the inputs and outputs kept within the specified allowable ranges, some circuit components may have elevated case temperatures. These components include but are not limited to linear regulators, switching transistors, pass transistors, current sense resistors, and heat sinks, which can be identified using the information in the associated documentation. When working with the EVM, please be aware that the EVM may become very warm.

4.3.2 EVMs are intended solely for use by technically qualified, professional electronics experts who are familiar with the dangers and application risks associated with handling electrical mechanical components, systems, and subsystems. User assumes all responsibility and liability for proper and safe handling and use of the EVM by User or its employees, affiliates, contractors or designees. User assumes all responsibility and liability to ensure that any interfaces (electronic and/or mechanical) between the EVM and any human body are designed with suitable isolation and means to safely limit accessible leakage currents to minimize the risk of electrical shock hazard. User assumes all responsibility and liability for any improper or unsafe handling or use of the EVM by User or its employees, affiliates, contractors or designees.

4.4 User assumes all responsibility and liability to determine whether the EVM is subject to any applicable international, federal, state, or local laws and regulations related to User's handling and use of the EVM and, if applicable, User assumes all responsibility and liability for compliance in all respects with such laws and regulations. User assumes all responsibility and liability for proper disposal and recycling of the EVM consistent with all applicable international, federal, state, and local requirements.

5. *Accuracy of Information:* To the extent TI provides information on the availability and function of EVMs, TI attempts to be as accurate as possible. However, TI does not warrant the accuracy of EVM descriptions, EVM availability or other information on its websites as accurate, complete, reliable, current, or error-free.

6. *Disclaimers:*
- 6.1 EXCEPT AS SET FORTH ABOVE, EVMS AND ANY WRITTEN DESIGN MATERIALS PROVIDED WITH THE EVM (AND THE DESIGN OF THE EVM ITSELF) ARE PROVIDED "AS IS" AND "WITH ALL FAULTS." TI DISCLAIMS ALL OTHER WARRANTIES, EXPRESS OR IMPLIED, REGARDING SUCH ITEMS, INCLUDING BUT NOT LIMITED TO ANY IMPLIED WARRANTIES OF MERCHANTABILITY OR FITNESS FOR A PARTICULAR PURPOSE OR NON-INFRINGEMENT OF ANY THIRD PARTY PATENTS, COPYRIGHTS, TRADE SECRETS OR OTHER INTELLECTUAL PROPERTY RIGHTS.
- 6.2 EXCEPT FOR THE LIMITED RIGHT TO USE THE EVM SET FORTH HEREIN, NOTHING IN THESE TERMS AND CONDITIONS SHALL BE CONSTRUED AS GRANTING OR CONFERRING ANY RIGHTS BY LICENSE, PATENT, OR ANY OTHER INDUSTRIAL OR INTELLECTUAL PROPERTY RIGHT OF TI, ITS SUPPLIERS/LICENSORS OR ANY OTHER THIRD PARTY, TO USE THE EVM IN ANY FINISHED END-USER OR READY-TO-USE FINAL PRODUCT, OR FOR ANY INVENTION, DISCOVERY OR IMPROVEMENT MADE, CONCEIVED OR ACQUIRED PRIOR TO OR AFTER DELIVERY OF THE EVM.
7. *USER'S INDEMNITY OBLIGATIONS AND REPRESENTATIONS.* USER WILL DEFEND, INDEMNIFY AND HOLD TI, ITS LICENSORS AND THEIR REPRESENTATIVES HARMLESS FROM AND AGAINST ANY AND ALL CLAIMS, DAMAGES, LOSSES, EXPENSES, COSTS AND LIABILITIES (COLLECTIVELY, "CLAIMS") ARISING OUT OF OR IN CONNECTION WITH ANY HANDLING OR USE OF THE EVM THAT IS NOT IN ACCORDANCE WITH THESE TERMS AND CONDITIONS. THIS OBLIGATION SHALL APPLY WHETHER CLAIMS ARISE UNDER STATUTE, REGULATION, OR THE LAW OF TORT, CONTRACT OR ANY OTHER LEGAL THEORY, AND EVEN IF THE EVM FAILS TO PERFORM AS DESCRIBED OR EXPECTED.
8. *Limitations on Damages and Liability:*
- 8.1 *General Limitations.* IN NO EVENT SHALL TI BE LIABLE FOR ANY SPECIAL, COLLATERAL, INDIRECT, PUNITIVE, INCIDENTAL, CONSEQUENTIAL, OR EXEMPLARY DAMAGES IN CONNECTION WITH OR ARISING OUT OF THESE TERMS AND CONDITIONS OR THE USE OF THE EVMS PROVIDED HEREUNDER, REGARDLESS OF WHETHER TI HAS BEEN ADVISED OF THE POSSIBILITY OF SUCH DAMAGES. EXCLUDED DAMAGES INCLUDE, BUT ARE NOT LIMITED TO, COST OF REMOVAL OR REINSTALLATION, ANCILLARY COSTS TO THE PROCUREMENT OF SUBSTITUTE GOODS OR SERVICES, RETESTING, OUTSIDE COMPUTER TIME, LABOR COSTS, LOSS OF GOODWILL, LOSS OF PROFITS, LOSS OF SAVINGS, LOSS OF USE, LOSS OF DATA, OR BUSINESS INTERRUPTION. NO CLAIM, SUIT OR ACTION SHALL BE BROUGHT AGAINST TI MORE THAN ONE YEAR AFTER THE RELATED CAUSE OF ACTION HAS OCCURRED.
- 8.2 *Specific Limitations.* IN NO EVENT SHALL TI'S AGGREGATE LIABILITY FROM ANY WARRANTY OR OTHER OBLIGATION ARISING OUT OF OR IN CONNECTION WITH THESE TERMS AND CONDITIONS, OR ANY USE OF ANY TI EVM PROVIDED HEREUNDER, EXCEED THE TOTAL AMOUNT PAID TO TI FOR THE PARTICULAR UNITS SOLD UNDER THESE TERMS AND CONDITIONS WITH RESPECT TO WHICH LOSSES OR DAMAGES ARE CLAIMED. THE EXISTENCE OF MORE THAN ONE CLAIM AGAINST THE PARTICULAR UNITS SOLD TO USER UNDER THESE TERMS AND CONDITIONS SHALL NOT ENLARGE OR EXTEND THIS LIMIT.
9. *Return Policy.* Except as otherwise provided, TI does not offer any refunds, returns, or exchanges. Furthermore, no return of EVM(s) will be accepted if the package has been opened and no return of the EVM(s) will be accepted if they are damaged or otherwise not in a resalable condition. If User feels it has been incorrectly charged for the EVM(s) it ordered or that delivery violates the applicable order, User should contact TI. All refunds will be made in full within thirty (30) working days from the return of the components(s), excluding any postage or packaging costs.
10. *Governing Law:* These terms and conditions shall be governed by and interpreted in accordance with the laws of the State of Texas, without reference to conflict-of-laws principles. User agrees that non-exclusive jurisdiction for any dispute arising out of or relating to these terms and conditions lies within courts located in the State of Texas and consents to venue in Dallas County, Texas. Notwithstanding the foregoing, any judgment may be enforced in any United States or foreign court, and TI may seek injunctive relief in any United States or foreign court.

Mailing Address: Texas Instruments, Post Office Box 655303, Dallas, Texas 75265
Copyright © 2015, Texas Instruments Incorporated

IMPORTANT NOTICE

Texas Instruments Incorporated and its subsidiaries (TI) reserve the right to make corrections, enhancements, improvements and other changes to its semiconductor products and services per JESD46, latest issue, and to discontinue any product or service per JESD48, latest issue. Buyers should obtain the latest relevant information before placing orders and should verify that such information is current and complete. All semiconductor products (also referred to herein as "components") are sold subject to TI's terms and conditions of sale supplied at the time of order acknowledgment.

TI warrants performance of its components to the specifications applicable at the time of sale, in accordance with the warranty in TI's terms and conditions of sale of semiconductor products. Testing and other quality control techniques are used to the extent TI deems necessary to support this warranty. Except where mandated by applicable law, testing of all parameters of each component is not necessarily performed.

TI assumes no liability for applications assistance or the design of Buyers' products. Buyers are responsible for their products and applications using TI components. To minimize the risks associated with Buyers' products and applications, Buyers should provide adequate design and operating safeguards.

TI does not warrant or represent that any license, either express or implied, is granted under any patent right, copyright, mask work right, or other intellectual property right relating to any combination, machine, or process in which TI components or services are used. Information published by TI regarding third-party products or services does not constitute a license to use such products or services or a warranty or endorsement thereof. Use of such information may require a license from a third party under the patents or other intellectual property of the third party, or a license from TI under the patents or other intellectual property of TI.

Reproduction of significant portions of TI information in TI data books or data sheets is permissible only if reproduction is without alteration and is accompanied by all associated warranties, conditions, limitations, and notices. TI is not responsible or liable for such altered documentation. Information of third parties may be subject to additional restrictions.

Resale of TI components or services with statements different from or beyond the parameters stated by TI for that component or service voids all express and any implied warranties for the associated TI component or service and is an unfair and deceptive business practice. TI is not responsible or liable for any such statements.

Buyer acknowledges and agrees that it is solely responsible for compliance with all legal, regulatory and safety-related requirements concerning its products, and any use of TI components in its applications, notwithstanding any applications-related information or support that may be provided by TI. Buyer represents and agrees that it has all the necessary expertise to create and implement safeguards which anticipate dangerous consequences of failures, monitor failures and their consequences, lessen the likelihood of failures that might cause harm and take appropriate remedial actions. Buyer will fully indemnify TI and its representatives against any damages arising out of the use of any TI components in safety-critical applications.

In some cases, TI components may be promoted specifically to facilitate safety-related applications. With such components, TI's goal is to help enable customers to design and create their own end-product solutions that meet applicable functional safety standards and requirements. Nonetheless, such components are subject to these terms.

No TI components are authorized for use in FDA Class III (or similar life-critical medical equipment) unless authorized officers of the parties have executed a special agreement specifically governing such use.

Only those TI components which TI has specifically designated as military grade or "enhanced plastic" are designed and intended for use in military/aerospace applications or environments. Buyer acknowledges and agrees that any military or aerospace use of TI components which have **not** been so designated is solely at the Buyer's risk, and that Buyer is solely responsible for compliance with all legal and regulatory requirements in connection with such use.

TI has specifically designated certain components as meeting ISO/TS16949 requirements, mainly for automotive use. In any case of use of non-designated products, TI will not be responsible for any failure to meet ISO/TS16949.

Products

Audio	www.ti.com/audio
Amplifiers	amplifier.ti.com
Data Converters	dataconverter.ti.com
DLP® Products	www.dlp.com
DSP	dsp.ti.com
Clocks and Timers	www.ti.com/clocks
Interface	interface.ti.com
Logic	logic.ti.com
Power Mgmt	power.ti.com
Microcontrollers	microcontroller.ti.com
RFID	www.ti-rfid.com
OMAP Applications Processors	www.ti.com/omap
Wireless Connectivity	www.ti.com/wirelessconnectivity

Applications

Automotive and Transportation	www.ti.com/automotive
Communications and Telecom	www.ti.com/communications
Computers and Peripherals	www.ti.com/computers
Consumer Electronics	www.ti.com/consumer-apps
Energy and Lighting	www.ti.com/energy
Industrial	www.ti.com/industrial
Medical	www.ti.com/medical
Security	www.ti.com/security
Space, Avionics and Defense	www.ti.com/space-avionics-defense
Video and Imaging	www.ti.com/video

TI E2E Community

e2e.ti.com