

## BMMI Series



BMMI Series is designed for low profile type with low RDC and ultra large current. Its molded magnetic shielded type is suitable for high-density mounting and ultra low buzz noise. Soldering conditions can be easily confirmed when mounting onto the board. This series also provides customers with embossed carrier type packaging for automatic mounting machine.

### Features

- RoHS, Halogen Free and REACH Compliance
- Low resistance and high current rating
- Magnetic core made by high performance magnetic powder

### Applications

- Laptop and desktop applications
- High current power supplies
- PMIC
- DC/DC converters

### Product Identification

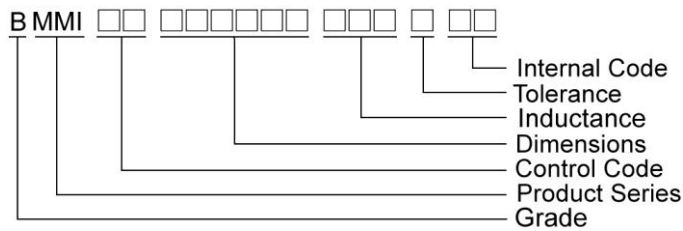

### Shape and Dimensions

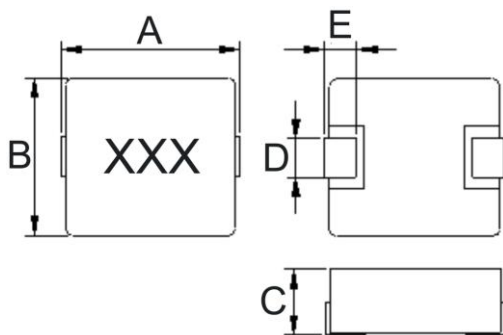

Dimensions in mm

TYPE	A	B	C	D	E
BMMI00040412	4.45±0.25	4.06±0.25	1.2Max	2.0±0.3	0.76±0.3
BMMI00050515	5.49±0.25	5.18±0.22	1.5Max	2.0±0.3	1.0±0.3
BMMI00060612	6.95±0.35	6.6±0.2	1.2Max	3.0±0.3	1.6±0.3
BMMI00060630	6.95±0.35	6.6±0.2	3.0Max	3.0±0.3	1.6±0.3
BMMI00131350	13.2±0.5	12.9Max	5.0Max	3.5±0.5	2.3±0.3
BMMI00131365	13.2±0.5	12.9Max	6.5Max	3.5±0.5	2.3±0.3

### Recommended Pattern

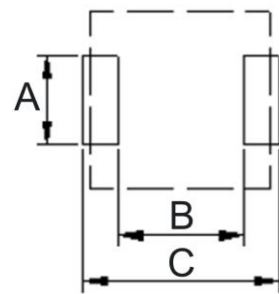

Dimensions in mm

TYPE	A	B	C
BMMI00040412	2.5	2.2	5.2
BMMI00050515	2.5	2.2	5.99
BMMI00060612	3.5	3.7	8.4
BMMI00060630	3.5	3.7	8.4
BMMI00131350	5.0	8.0	14.5
BMMI00131365	5.5	8.0	14.5

# Molding Power Inductors – BMMI Series

## Electrical Characteristics

Part Number	Inductance (uH)	Tolerance (±%)	Test Frequency (kHz)	RDC(mΩ) Max(Typ.)	Isat(A) Max(Typ.)	Irms(A) Max(Typ.)	Marking
BMMI000404124R7MX1	4.7	20	100	145(124)	2.8(3.2)	2.1(2.4)	4R7

**Note: When ordering, please specify tolerance code. Tolerance: M=±20%**

- Operating temperature range - 55°C ~ 125°C(Including self - temperature rise)
- Isat for Inductance drop 30% from its value without current
- I rms for a 40°C temperature rise from 25°C ambient with current
- Measure Equipment :  
 L : WK 3260B or WK 6500P, 100kHz 0.25V  
 RDC : CHEN HWA 502 or CHEN HWA 46502B  
 I rms : CHROMA 1810

**Test Instruments : WK3260B Impedance / Material Analyzer**

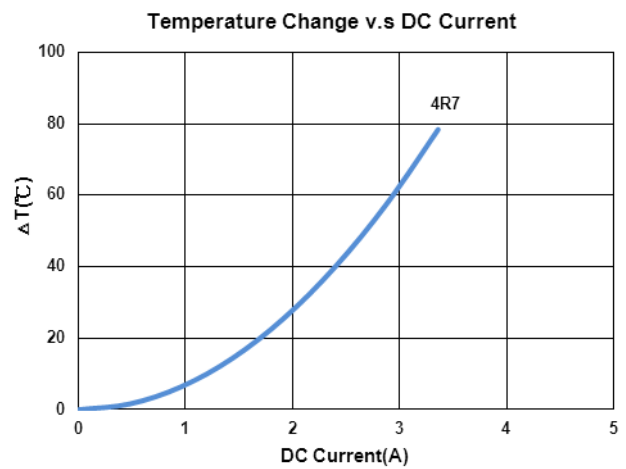
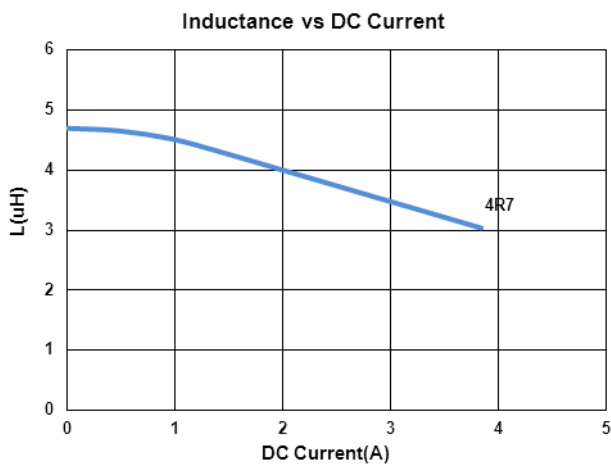

# Molding Power Inductors – BMMI Series

## Electrical Characteristics

Part Number	Inductance (uH)	Tolerance (±%)	Test Frequency (kHz)	RDC(mΩ) Max(Typ.)	Isat(A) Max(Typ.)	Irms(A) Max(Typ.)	Marking
BMMI000505151R0MX2	1.0	20	100	23(19)	8.1(9.5)	5.8(6.5)	1R0

**Note: When ordering, please specify tolerance code. Tolerance: M=±20%**

- Operating temperature range - 55°C ~ 125°C(Including self - temperature rise)
- Isat for Inductance drop 30% from its value without current
- I rms for a 40°C temperature rise from 25°C ambient with current
- Measure Equipment :  
 L : WK 3260B or WK 6500P, 100kHz 0.25V  
 RDC : CHEN HWA 502 or CHEN HWA 46502B  
 I rms : CHROMA 1810

**Test Instruments : WK3260B Impedance / Material Analyzer**

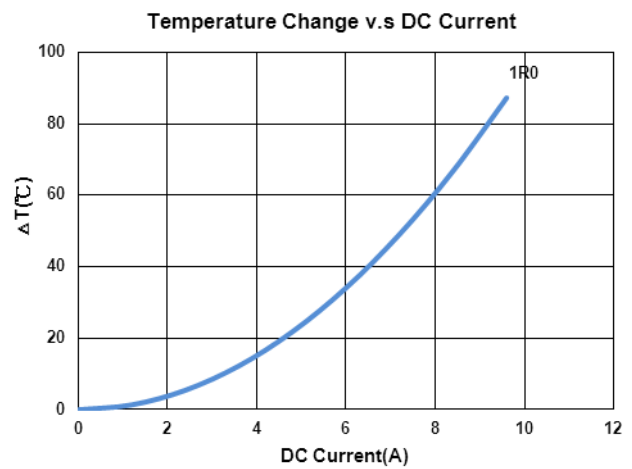
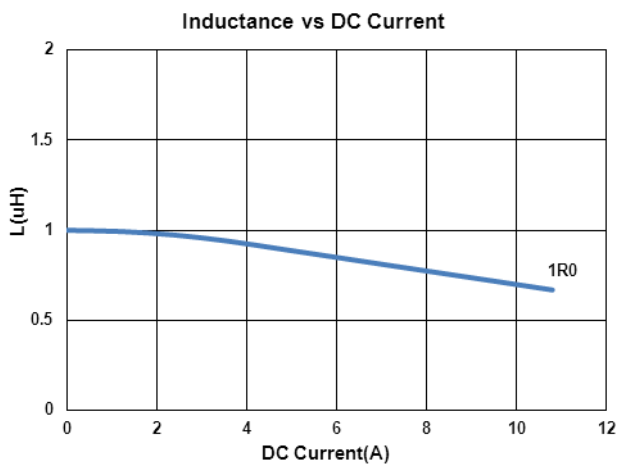

# Molding Power Inductors – BMMI Series

## Electrical Characteristics

Part Number	Inductance (uH)	Tolerance (±%)	Test Frequency (kHz)	RDC(mΩ) Max(Typ.)	Isat (A)Typ.	Irms (A)Typ.	Marking
BMMI000606121R0MX1	1.0	20	100	29(25)	7.5	6.0	1R0

**Note: When ordering, please specify tolerance code. Tolerance: M=±20%**

- Operating temperature range - 55°C ~ 125°C(Including self - temperature rise)
- Isat for Inductance drop 30% from its value without current
- Irms for a 40°C temperature rise from 25°C ambient with current
- Measure Equipment :  
 L : WK 3260B or WK 6500P, 100kHz 0.25V  
 RDC : CHEN HWA 502 or CHEN HWA 46502B  
 Irms : CHROMA 1810

### Test Instruments : WK3260B Impedance / Material Analyzer

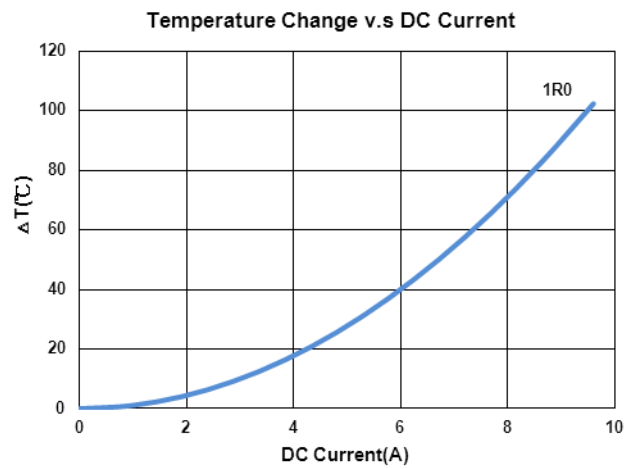
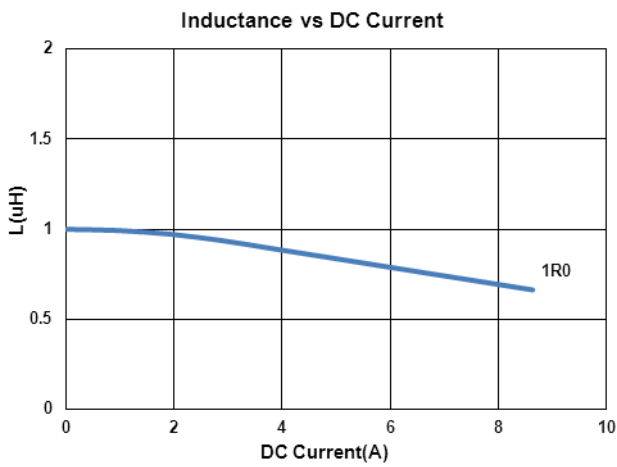

# Molding Power Inductors – BMMI Series

## Electrical Characteristics

Part Number	Inductance (uH)	Tolerance (±%)	Test Frequency (kHz)	RDC(mΩ) Max(Typ.)	Isat(A) Max(Typ.)	Irms(A) Max(Typ.)	Marking
BMMI00060630R30MX1	0.22	20	100	2.4(2.0)	27(31)	25.5(28)	R22
BMMI00060630R47MX1	0.47	20	100	3.3(2.9)	20(23)	20(23)	R47
BMMI000606301R0MX1	1.0	20	100	6.4(5.6)	14(16)	14.4(16)	1R0
BMMI000606301R5MX1	1.5	20	100	8.9(7.7)	12.7(14.8)	11(12)	1R5
BMMI000606302R2MX1	2.2	20	100	12.8(11)	12(14)	9(10)	2R2
BMMI000606303R3MX1	3.3	20	100	21(18.5)	10(11)	7(8)	3R3
BMMI000606304R7MX1	4.7	20	100	26(23.6)	7(8)	6(6.7)	4R7

**Note: When ordering, please specify tolerance code. Tolerance: M=±20%**

- Operating temperature range - 55°C ~ 125°C(Including self - temperature rise)
- Isat for Inductance drop 30% from its value without current
- I rms for a 40°C temperature rise from 25°C ambient with current
- Measure Equipment :  
 L : WK 3260B or WK 6500P, 100kHz 0.25V  
 RDC : CHEN HWA 502 or CHEN HWA 46502B  
 I rms : CHROMA 1810

**Test Instruments :** WK3260B Impedance / Material Analyzer

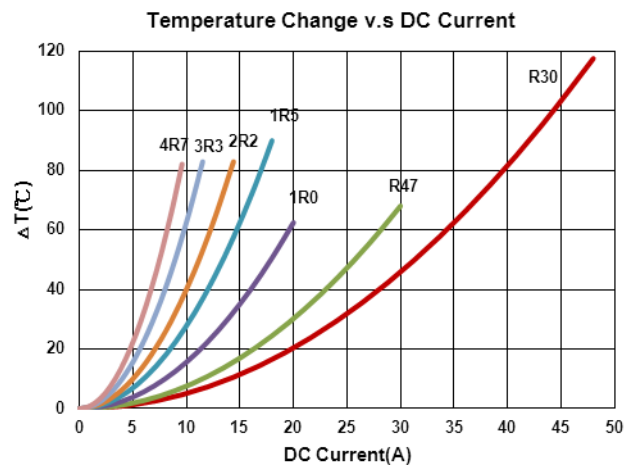
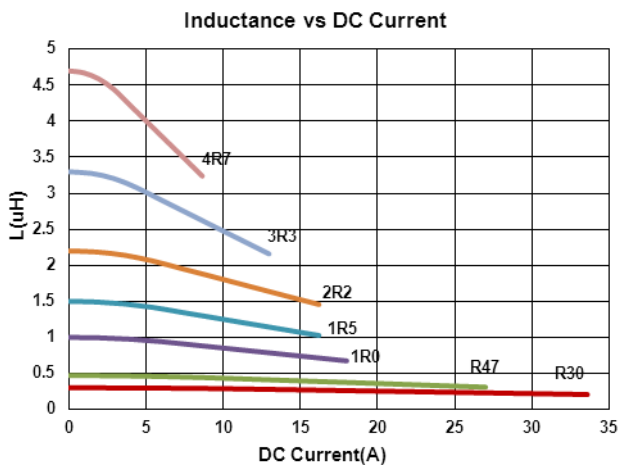

# Molding Power Inductors – BMMI Series

## Electrical Characteristics

Part Number	Inductance (uH)	Tolerance (±%)	Test Frequency (kHz)	RDC(mΩ) Max(Typ.)	Isat (A)Typ.	Irms (A)Typ.	Marking
BMMI001313503R3MX1	3.3	20	100	9.2(7.7)	32	15	3R3

**Note: When ordering, please specify tolerance code. Tolerance: M=±20%**

- Operating temperature range - 55°C ~ 125°C(Including self - temperature rise)
- Isat for Inductance drop 20% from its value without current
- Irms for a 40°C temperature rise from 25°C ambient with current
- Measure Equipment :  
 L : WK 3260B or WK 6500P, 100kHz 0.25V  
 RDC : CHEN HWA 502 or CHEN HWA 46502B  
 Irms : CHROMA 1810

**Test Instruments :** WK3260B Impedance / Material Analyzer

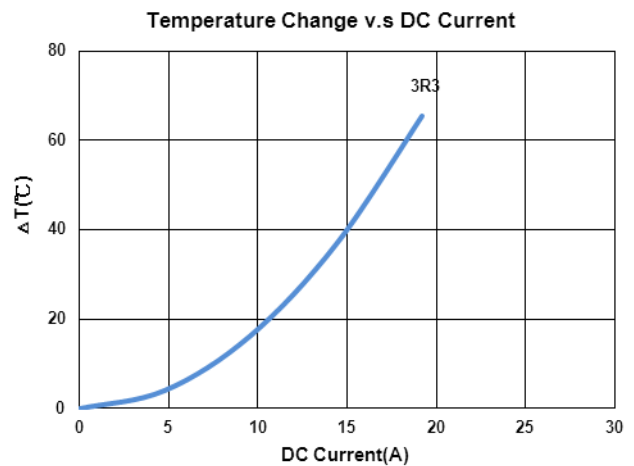
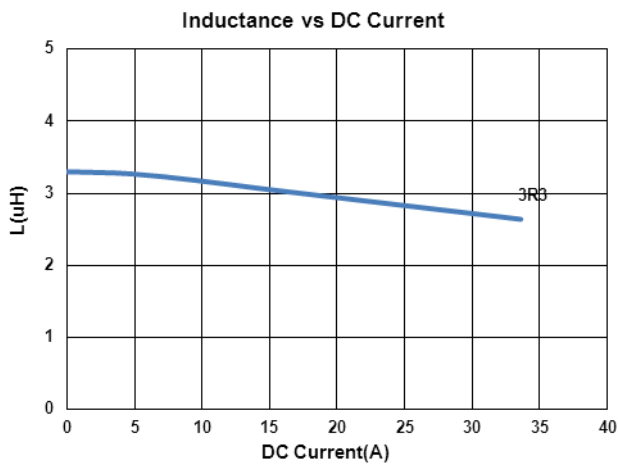

# Molding Power Inductors – BMMI Series

## Electrical Characteristics

Part Number	Inductance (uH)	Tolerance (±%)	Test Frequency (kHz)	RDC(mΩ) Max(Typ.)	Isat(A) Max(Typ.)	Irms(A) Max(Typ.)	Marking
BMMI001313653R3MX1	3.3	20	100	4.4(3.75)	40(42)	20(22)	3R3

**Note: When ordering, please specify tolerance code. Tolerance: M=±20%**

- Operating temperature range - 55°C ~ 125°C(Including self - temperature rise)
- Isat for Inductance drop 30% from its value without current
- I rms for a 40°C temperature rise from 25°C ambient with current
- Measure Equipment :  
 L : WK 3260B or WK 6500P, 100kHz 0.25V  
 RDC : CHEN HWA 502 or CHEN HWA 46502B  
 I rms : CHROMA 1810

### Test Instruments : WK3260B Impedance / Material Analyzer

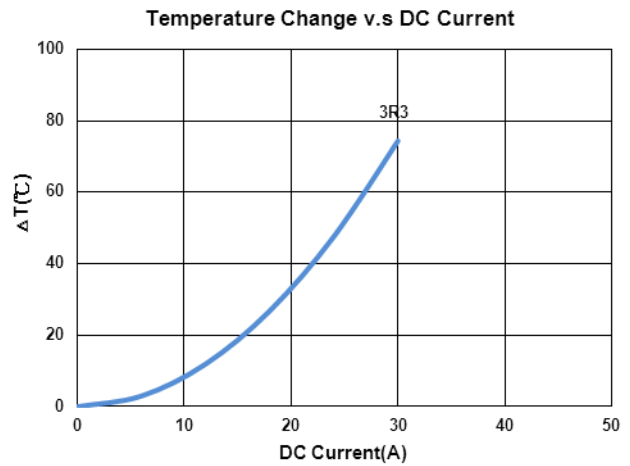
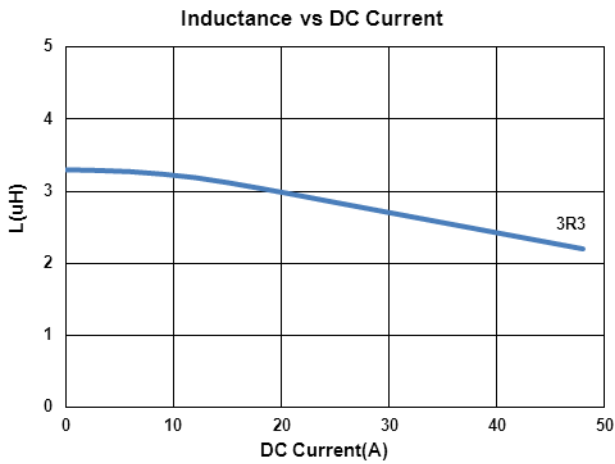

## Packaging Specifications

Tape Dimensions

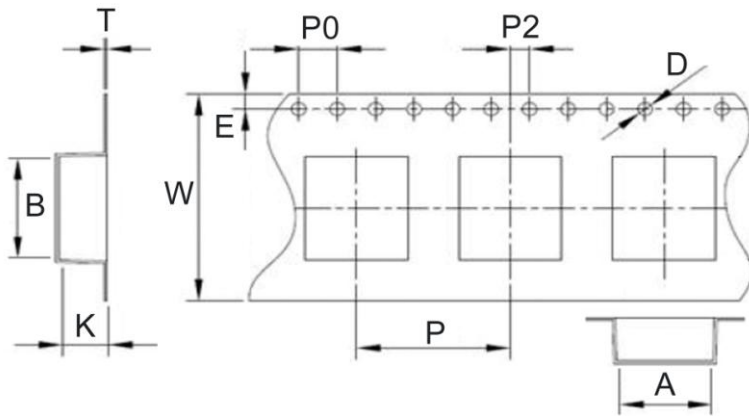

Reel Dimensions

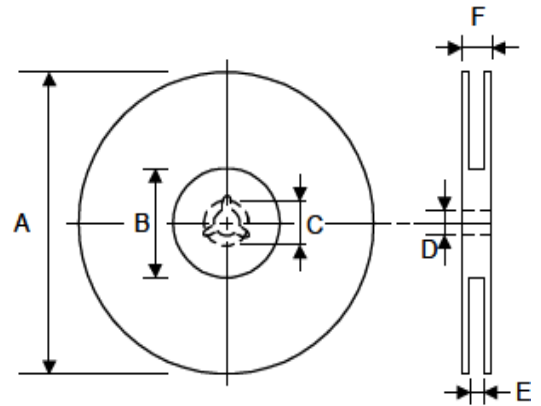

Dimensions in mm

TYPE	Tape Dimensions										Reel Dimensions						Quantity PCS / REEL
	A	B	K	T	D	E	W	P	P0	P2	A	B	C	D	E	F	
BMMI00040412	4.5	4.9	1.7	0.35	1.5	1.75	12	8	4	2	330	100	21.5	13	12.4	17.4	2000
BMMI00050515	5.4	5.8	1.95	0.3	1.5	1.75	12	8	4	2	330	100	21.5	13	12.4	17.4	1000
BMMI00060612	6.8	7.5	1.5	0.3	1.5	1.75	16	12	4	2	330	100	21.5	13	16.4	21.4	2000
BMMI00060630	6.9	7.6	3.4	0.35	1.5	1.75	16	12	4	2	330	100	21.5	13	16.4	21.4	1000
BMMI00131350	13.4	14.0	5.0	0.4	1.5	1.75	24	16	4	2	330	100	21.5	13	24.2	29.2	250
BMMI00131365	13.4	14.1	6.8	0.4	1.5	1.75	24	16	4	2	330	100	21.5	13	24.2	29.2	250