

BM77EVB Evaluation Kit User's Guide

iSSC Technologies Corp.

Revision History

| Date | Revision Content | Version |
|------------|------------------------------------|---------|
| 2014/10/03 | Revision for BM77EVB WPS, Oct 2014 | 0.4 |
| | | |
| | | |

Table of Contents

| | |
|---|-----------|
| 1. Overview..... | 3 |
| 1.1. BM77EVB Description..... | 3 |
| 1.2. Features..... | 4 |
| 2. Block Diagram | 5 |
| 3. Interface Description..... | 6 |
| 3.1. Power Switch Settings | 7 |
| 3.2. Mode Definitions | 7 |
| 3.3. Mode Switch Settings..... | 7 |
| 4. Quick Start Guide to Using the BM77EVB | 9 |
| 4.1. Bluetooth SPP connection to Android Smartphone/Tablet | 9 |
| 4.2. Bluetooth Low Energy Data Connection to iOS Device | 17 |
| 5. Appendix A: BM77SPP03 Module PIN Assignment | 27 |
| 6. Appendix B: BM77EVB Schematic | 29 |
| 7. Appendix C: Q & A | 32 |
| 8. Appendix D: Reversion History | 33 |

1. Overview

This document describes the hardware and software for the ISSC BM77EVB evaluation kit.

The BM77EVB allows the designer to evaluate and demonstrate the capabilities of the ISSC BM77 Dual Mode Bluetooth RF Module. The evaluation board includes an integrated configuration and programming interface for plug-and-play capability. It also includes on-board connection and data status LEDs enabling rapid prototyping and fast time to market.

In addition to BM77EVB hardware, several software applications are provided to demonstrate Bluetooth data connections to the onboard BM77 module. The demonstration software consists:

- Android Chat Application (SPP)
- iOS Bluetooth Terminal (BLETR)
- BT Chat Tool

1.1. BM77EVB Description

BM77EVB provides rapid prototyping and developing for Bluetooth data applications for Classic SPP or Bluetooth Low Energy. It can be powered via USB host or external battery Li-Battery. The BM77EVB utilizes the BM77 module, a fully certified Bluetooth 4.0 dual mode RF module supporting Bluetooth Classic SPP (Serial Port Profile) and Bluetooth Low Energy (BTLE) – providing a Bluetooth serial data connections. The BM77EVB provides a USB UART converter allowing flexible interface to host PC, a PC terminal utility and SmartPhone APPs to drive both classic SPP and BTLE data connections.

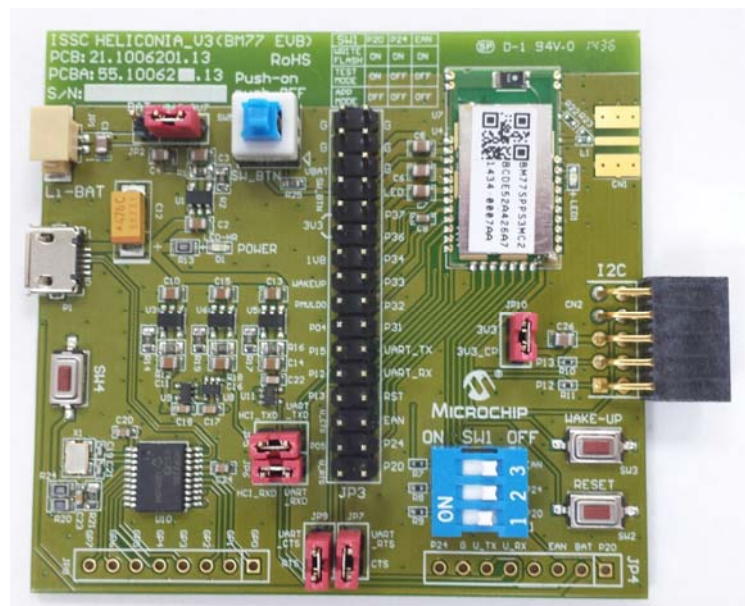

1.2. Features

- Fully certified on board Bluetooth 3.0+EDR and Bluetooth 4.0 stack
- Class 2 transmitter, +2dBm typical
- Transparent serial data connection over Bluetooth Classic Serial Port Profile (SPP) and Bluetooth Low Energy transparent serial data service
- Automatic configuration mode for quick setup (default)
- Manual configuration mode where MCU can access configuration settings
- Configuration settings stored in EEPROM
- Onboard dipswitch block to set operating modes
- 32-pin header to fully access BM77 pins
- Embedded MCP2200 USB-UART converter, no need for extra converter board or cable
- Integrated programming interface to update firmware and configuration settings

2. Block Diagram

The diagram below shows a simplified block diagram for the BM77EVb. For more detailed information please refer to BM77EVb schematic in Appendix B, BM77EVb Schematic.

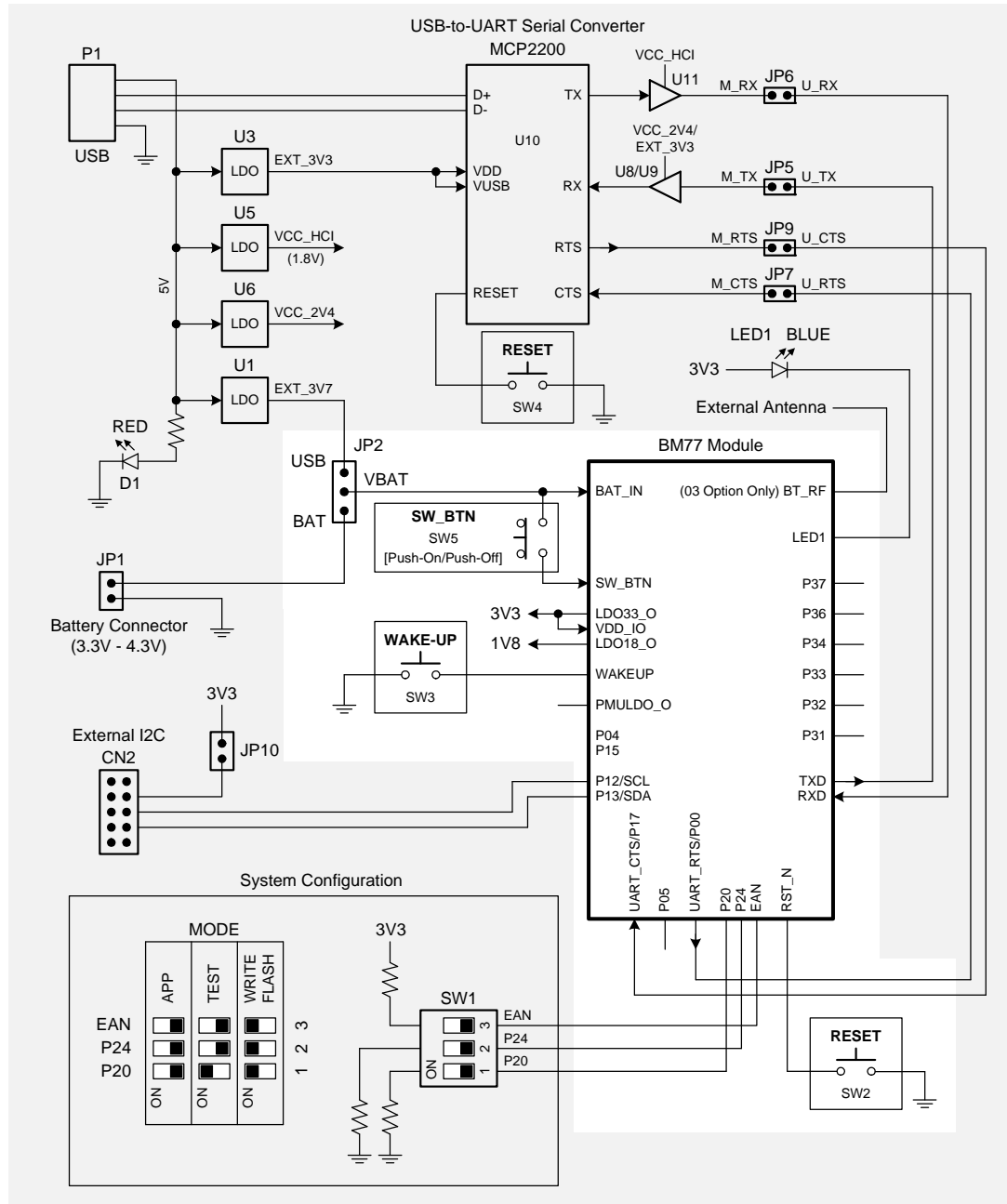

BM77 EVB BLOCK DIAGRAM

Last Revised: 2014-08-24 SB

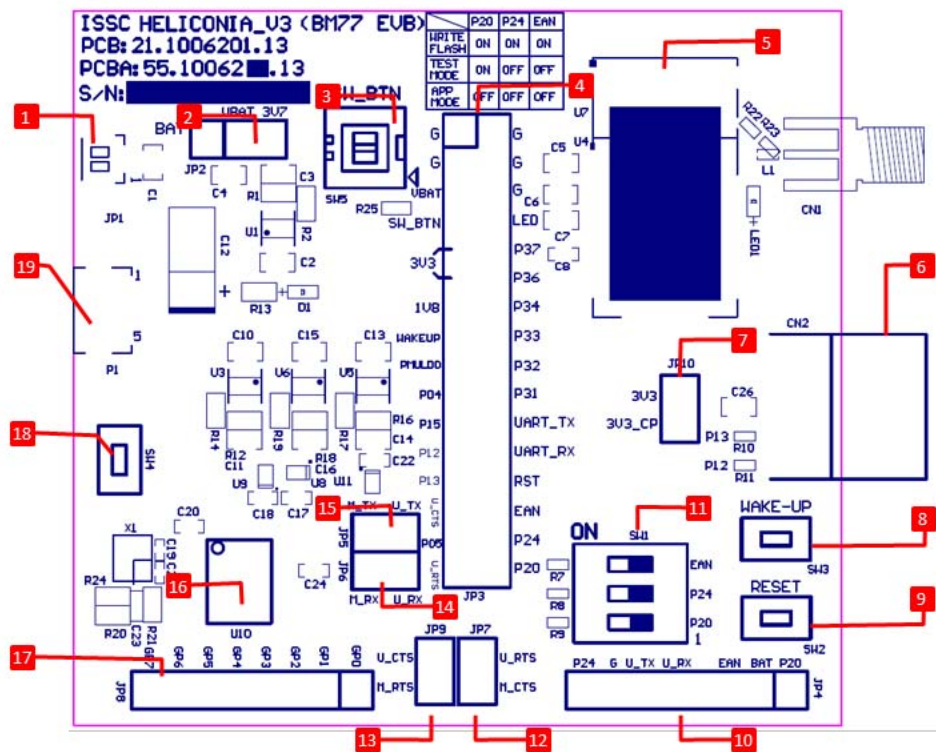

3. Interface Description

The illustration below shows a BM77EVB in its default configuration as shipped.



Description



1. JP1- Battery connector for Li-Ion Battery, Voltage range 4.2~3.3V
2. JP2- Power source jumper

| | |
|---|------------------------------------|
|  | Source from BAT (4.2V~3.3) |
|  | Source from USB (5V->LDO->3.7V) |

3. SW5- The path between SW_BTN & BAT_IN, the button must be pressed down to make BM77 work.
4. JP3- Module 32-PIN out for connecting BM77 module to MCU
5. Bluetooth Module- BM77
6. I2C expansion port
7. I2C power jumper
8. SW3- Wake up button to wake up module from shutdown state

9. SW2- Reset button for Bluetooth module
10. JP4- Connect with iSSC propriety 8 PIN connector (EDGAR). Use Li-Ion battery power and switch SW1 OFF while using EDGAR.
11. SW1- Mode Switch (see 3.2 Mode Definition, 3.3 Mode Settings)
12. JP7- CTS path of UART between BM77 & MCP2200. Remove the jumper if not using flow control.
13. JP9- RTS path of UART between BM77 & MCP2200. Remove the jumper if not using flow control.
14. JP6- RX path of UART between BM77 & MCP2200. Remove the jumper if trying to connect MCU & BM77.
15. JP5- TX path of UART between BM77 & MCP2200. Remove the jumper if trying to connect MCU & BM77.
16. U10- Microchip MCP2200 chip, USB/UART converter.
17. JP8- All the GPIO PIN connected to Microchip MCP2200.
18. SW4- Reset button for Microchip MCP2200
19. USB Connector- Micro USB connector

3.1. Power Switch Settings



| Mode | JP2 |
|----------------------|---|
| USB 5V |  |
| BAT 4.2V~3.3V |  |

* Notice: SW5 button must be pressed down to wake BM77.

3.2. Mode Definitions

| | Switch Number | 1 | 2 | 3 |
|---|---------------|---|---|---|
|  | Pin | P20 | P24 | EAN |
| | ON | Low | Low | High |
| | Function | Test Mode High=Disable/ Application Low=Enable/ Test Mode | Flash Write High=Disable Low=Enable | Boot by Flash or ROM High=ROM Low=Flash |

3.3. Mode Switch Settings

| Mode | Switch | PIN Definition |
|-------------------------------------|---|--|
| Write Flash |  | 1. P20: Low 2. P24: Low 3. EAN: High |
| Test Mode (Write EEPROM) |  | 1. P20: Low 2. P24: High |

| | | |
|----------------------------------|---|---|
| | | 3. EAN: Low |
| Application (default) |  | 1. P20: High 2. P24: High 3. EAN: Low |

4. Quick Start Guide to Using the BM77EVB

The following sections describe how to establish Bluetooth serial data connections using the BM77EVB. The purpose of the exercise is to demonstrate the basic data capabilities of the BM77EVB, and interoperability with other Bluetooth devices. Please note that in all these demonstrations, the BM77EVB is a Bluetooth slave waiting for a connection initiated by the Bluetooth master device.

For this demonstration, the following hardware and software is required:

Required Hardware:

- BM77EVB Evaluation Kit, p/n EV77SPPS3MC2A available on www.microchipdirect.com
- Bluetooth enabled Smartphone or Tablet
 - Android device running Android 4.3 or later
 - iOS: iPhone 4S or later, iPad3 or later, must support Bluetooth Low Energy
- Windows Host PC with USB port

Required Software:

The software applications needed to demonstrate the BM77EVB is show below:

- BT Chat Tool, “**BT Chat v004.exe**” available at www.microchip.com/BM77
- Android Chat Tool, “**BTChat_V1.0.3.apk**” available www.microchip.com/BM77
- iOS Terminal “**BLETR**”, available on Apple AppStore™
- MCP2200 driver for Windows, available at www.microchip.com/MCP2200

4.1. Bluetooth SPP connection to Android Smartphone/Tablet

In this demonstration a Bluetooth (SPP) data connection will be established between the BT Chat Tool, across BM77EVB to the Smartphone application. **For the SPP demonstration an Android 4.3 or later smartphone or tablet is required.**

As illustrated below, the host PC runs a BT Chat Tool application, which transfers serial data over a COM port (USB virtual COM port) to BM77EVB, where it is transmitted over a Bluetooth connection to the remote Bluetooth host, which is this example is a Smartphone application.

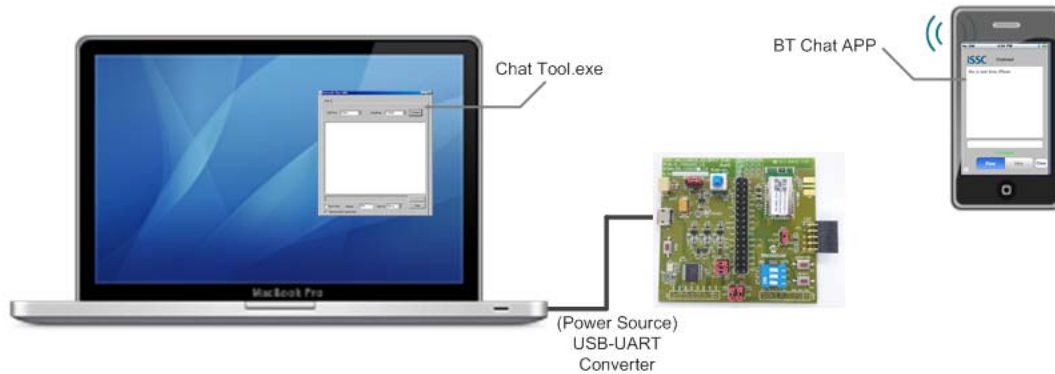

Step 1. Verify JP2 is configured for USB power.

Default is using **USB** as the main power supply.

Step 2. Verify SW1 switches are set to Application mode.

Make sure the **SW1** is under the **Application** Mode. 1: *OFF*, 2: *OFF*, 3: *OFF*

Step 3. Verify SW5 button is in the ON (pushed down).

Step 4. Using the micro USB cable, connect the BM77EVB to host PC USB port to power up EVB.

The blue connection LED1 indicates connection state as follows:

Stand-by State- the **LED1** of EVB will blink **once** at a time. (Blue)

Pairing, Connected State- the **LED01** will blink **twice** at a time.

Step 5. Verify Virtual COM port is created

If a virtual COM is not observed in the Device Manager port list, it may be necessary to install Microchip MCP2200 driver. (Search Internet by typing keyword" Microchip MCP2200 Driver")

Step 6. Run the **BT Chat Tool.exe** on your PC and make sure the COM Port is connected.

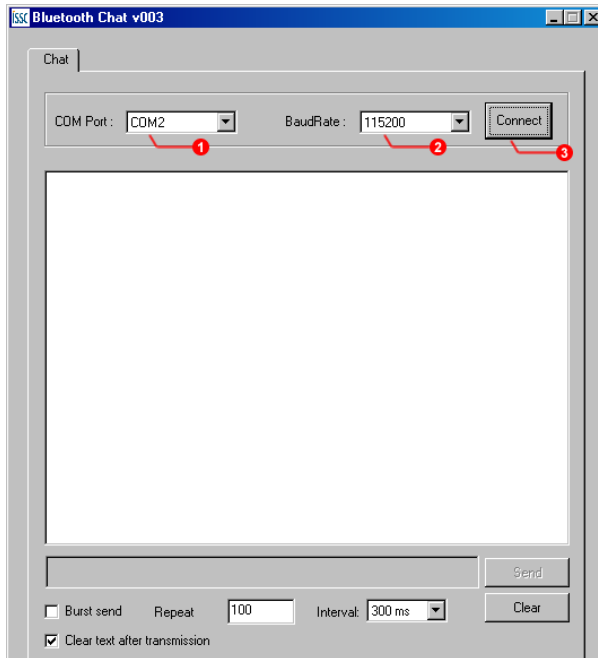

- a. Select the **COM Port** assigned to the BM77EVB
- b. Verify default **BaudRate** is 115200
- c. Click **Connect** button.

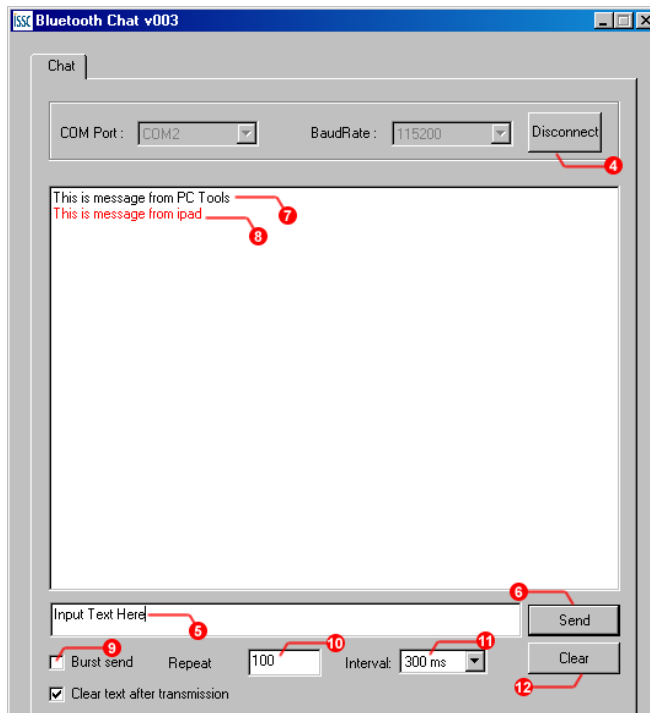

- d. The **Connect** button will change into a **Disconnect** button after connected.
- e. Text box to enter characters to transmit.
- f. Click **Send** to transmit text is to SmartPhone over BM77EVB Bluetooth connection.

- g. The **Black** text are sent from PC tool (Bluetooth EVB)
- h. The **Red** texts are sent from smart phone
- i. Click the check box of **Burst Send** will be continuous to send text from this tool.
- j. **Repeat** column means the how many times these texts will be resend.
- k. **Interval** means the interval between two records.
- l. **Clear** button will clear up the texts on the screen.

Step 7. Install the Android BT Chat APP on the Android device.

The installation is performed by copying or downloading the “**BTChat_V1.0.3.apk**” file onto the Android device. The APK file can be copied onto Android device by using an SD Card to transfer file, or plugging Android device into host PC where Android device mounts as external USB drive (Android MTP is required on host). Once the APK file copied onto Android device, follow the instructions below.

- a. As shown below in left illustration, use and opening from file from Android File Manager “My Files” App. It may be necessary to enable the “Unknown Sources” in Device Security settings.
- b. After successful install, the BtChat APP is displayed in Application view

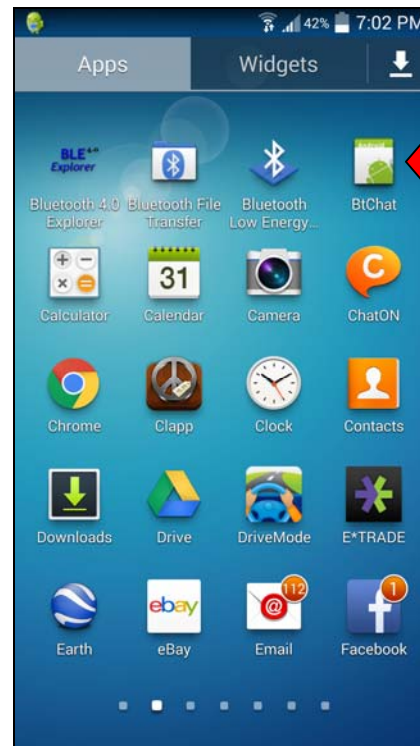
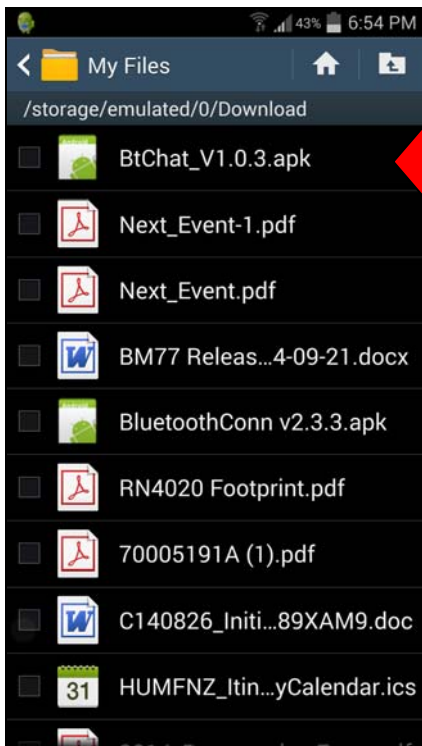

Step 8. Pairing the BM77EVB to the Android Device

- a. Open **Settings/ Bluetooth** page and **ON** the Turn On Bluetooth.
- b. Press **Scan** the button in step 2 to initiate the Bluetooth Device scan
- c. Find the BM77EVB device named **“Dual-SPP”** and select it to start the pairing process.
- d. Once paired, the Dual-SPP (BM77EVB) device will be listed in paired device list.

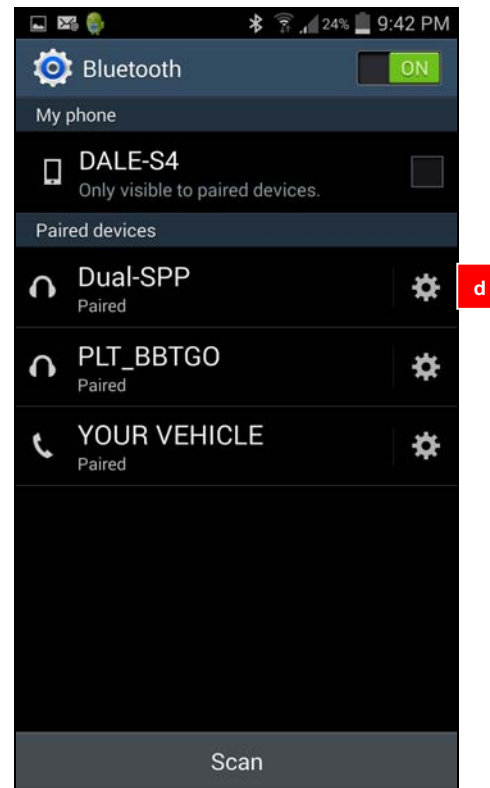
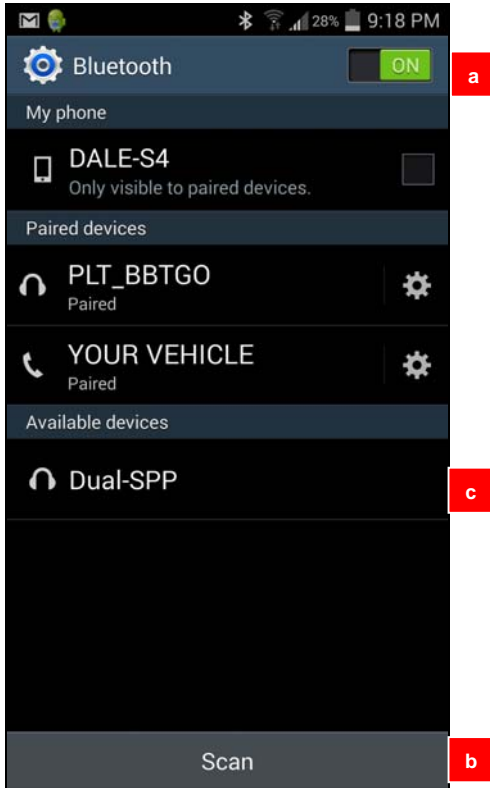

Step 9. Launch the BtChat APP on Android Device

- a. BT Chat APP main window is displayed.
- b. Use the Android menu button to open BT Chat menu options. Select the “Setting” button to open APP setting view.
- c. Enable the “Show Rx Text” options. Press the “Back” button to return to main window.

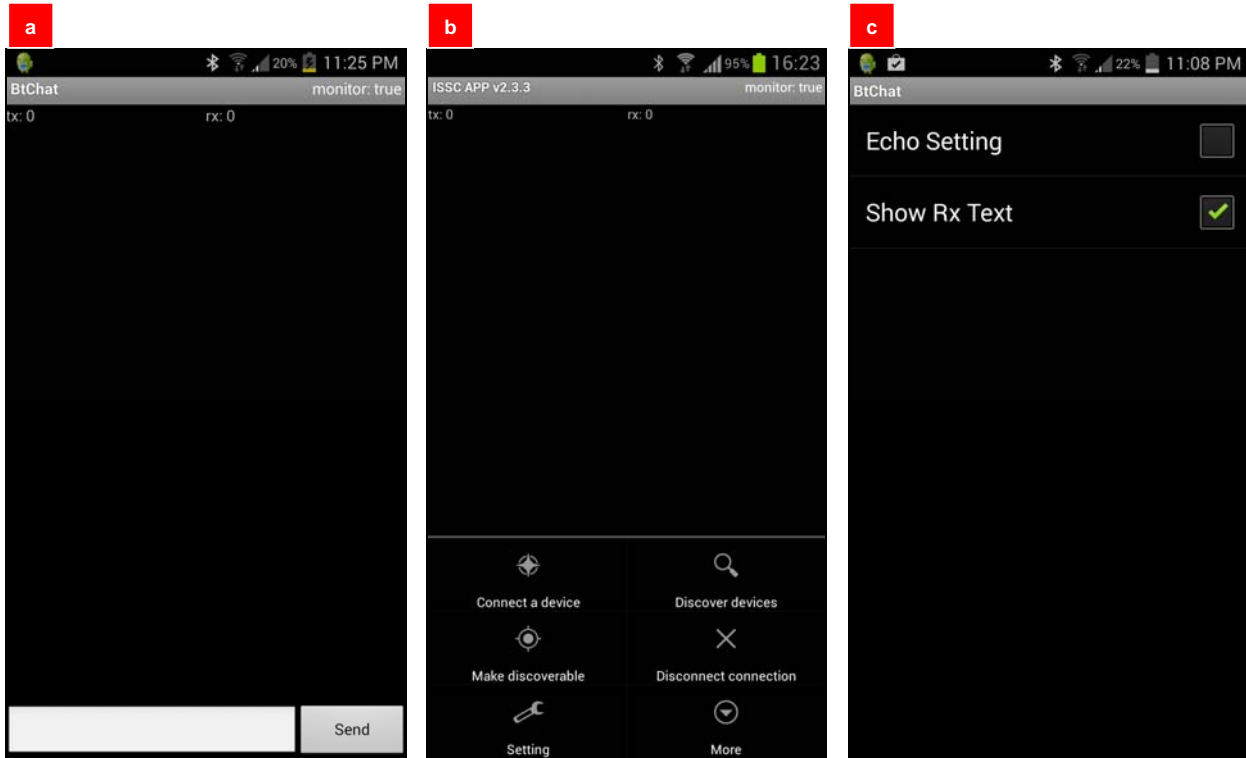

Step 10. Setting up Bluetooth SPP connection to the BM77EVB device

- a. From BT Chat APP main window, press the Android menu button to open BT Chat menu options. Select the **“Connect a device”** button to open paired device list.
- b. Select the **“Dual-SPP”** device to open an SPP connection to BM77EVB.
- c. After connection is established the status message is displayed in main window.

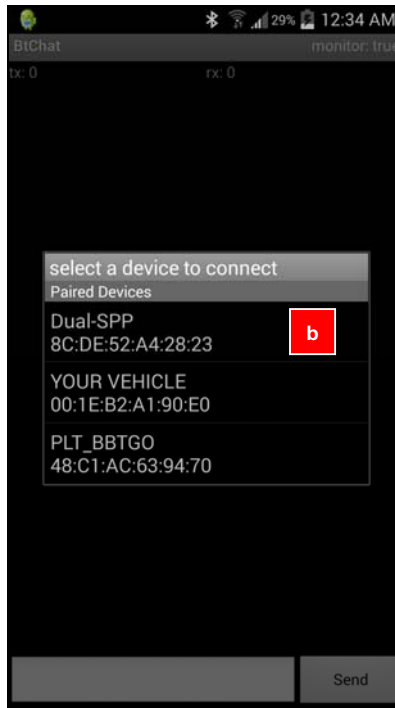
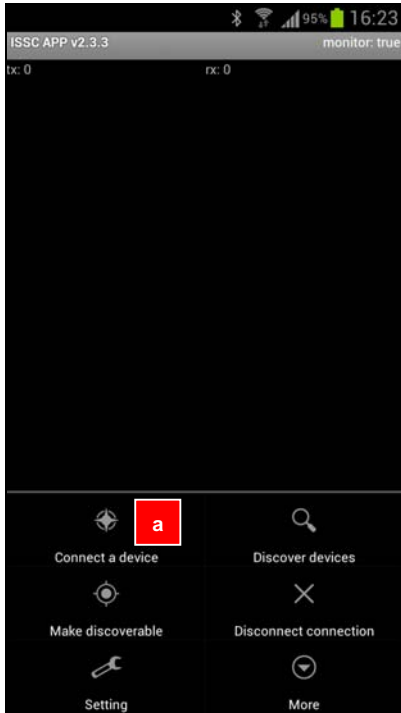

Step 11. Transferring data from BM77 to Android Device via Bluetooth SPP connection

Launch the Bluetooth Chat application on host PC tool and set the correct COM port corresponding to the BM77EVB.

- a. Enter text to send in BTChat Android APP
- b. Click “Send” to transmit text to BM77 connected to Bluetooth Chat on PC
- c. Observe received text in red font color on Bluetooth Chat PC
- d. Enter enter text to send in Bluetooth Chat PC
- e. Click “Send” to transmit text to Android BTChat Android APP
- f. Observe received text in BTChat Android APP

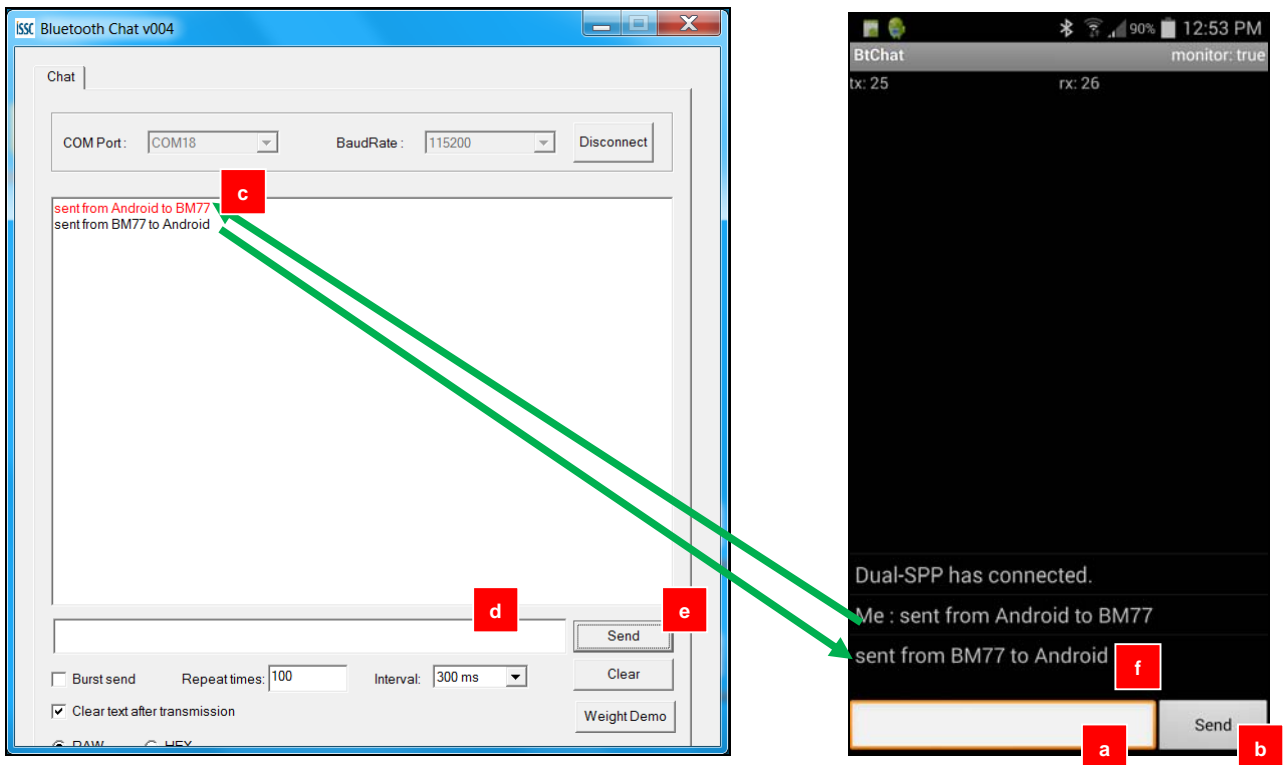

4.2. Bluetooth Low Energy Data Connection to iOS Device

This demonstration show how serial data is transmitted from BM77EVB (via PC Chat) to an iOS device using Bluetooth Low Energy connection. This demonstration uses ISSC BLETR APP to connection to the BM77EVB. Bluetooth Low Energy is utilized since iOS devices do not support Bluetooth Classic SPP data connections. A key feature of the BM77 is transparent serial data connection from BM77 UART to an iOS device.

- a. Using an iPhone 4S or later, iPad3 or later device, download and install “ISSC BLETR” APP. As illustrated below, the BLETR App is available on the AppStore.

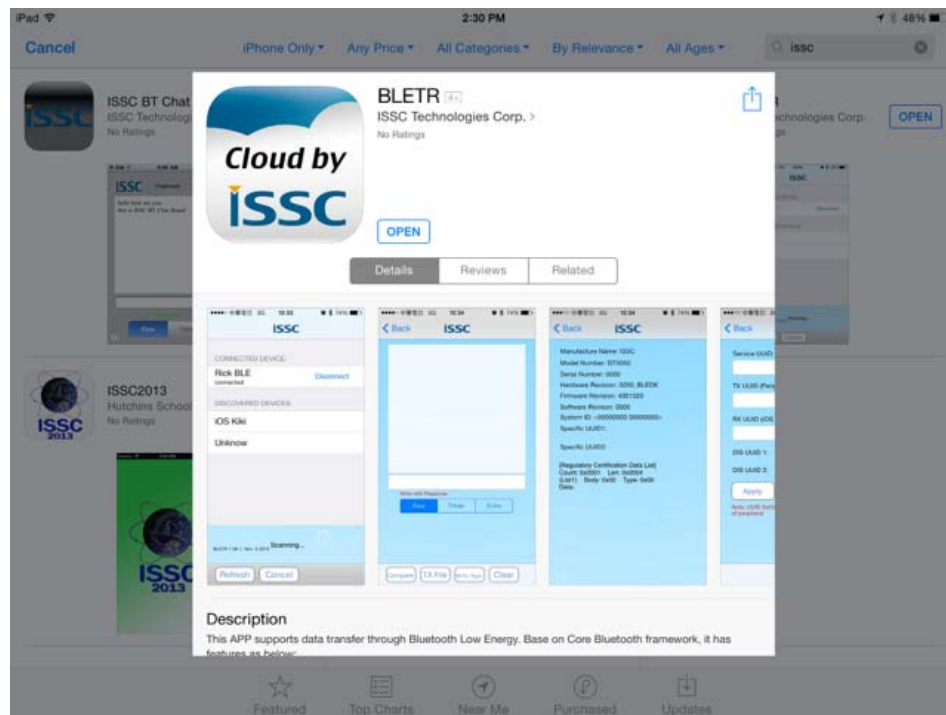

- b. Turn on the **Bluetooth** radio in iPhone, iPod or iPad Settings application.



- c. Go to **Settings/ General/ Bluetooth** Page.
d. Turn **ON** the Bluetooth.
e. Launch the **iSSC BLETR APP** and it will scan the Bluetooth Low Energy Peripheral devices and list them. If the device does not appear press the "Refresh" button to restart the BTLE peripheral scan. Find the **Dual-SPP** BTLE peripheral device. Select it to start a connection to the BM77EVB named **Dual-SPP**.



- f. After a successful connection to BM77EVB, BLETR will display the device as connected as shown below.



g. Select the connected Dual-SPP device to display the top level view. This view presents three options when connected to a BM77EVB.

Transparent - View to display received data, send data, and enable features

Proprietary- This view sets Bluetooth Low Energy connection parameters

Device Info -This view displays the settings for Bluetooth Low Energy Device Information Service

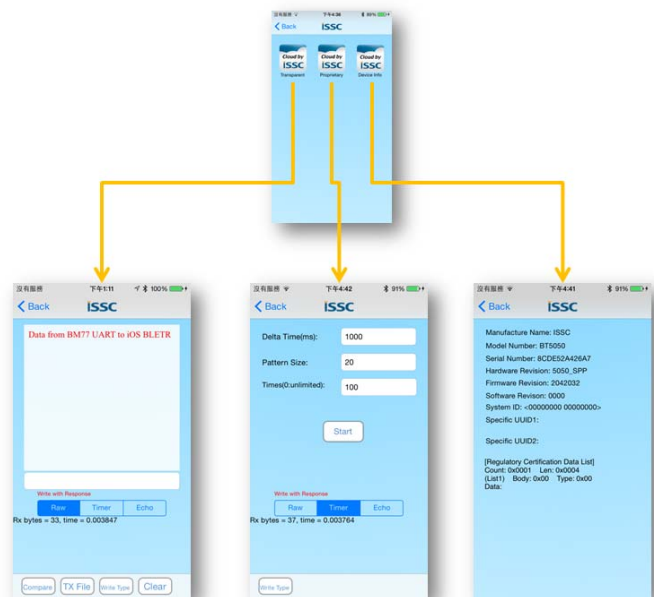

- h. Selecting “Transparent” button opens the transparent Serial Data view as shown below. The default mode is Raw (ASCII) mode where any data characters received are displayed in the large text box in red font.

Data Mode Transfer

Tx/Rx Data View
This text box displays all sent data from BLETR and received data from BM77. Received text is displayed in Red font color. Sent text is displayed in black text color.

Send Data Box
Text box used to enter the text that will be sent to BM77. Select it to bring up the soft keyboard and enter the text. Press the “Send” button to soft keyboard to transmit the text.

Raw Mode
Displays all received and sent data as ASCII instead of HEX value. Raw is default display mode.

Timer Mode
The Timer view allows BLETR to send repeated text patterns using the following: (1) configuration interval between transmission, (2) number of characters per transmission (3) number of times to transmit.

Echo Mode
When Echo mode is enabled any character received is transmitted back to sender.

Compare
Not Supported

TX File
Performs a block transfer of files of various sizes.

Clear
Clears the text from Tx/Rx text box.

Write Type
Toggle between Write with Response and Write w/o Response. Write w/o Response provides increased throughput.

To send data from BLETR iOS device to the BM77, select the input text box. The soft keyboard will be displayed as shown below. Enter text in the input text box. Click “Send” button to transmit text to BM77.



After clicking “Send” the text is received via the BM77 UART and displayed in the BT CHAT text window.

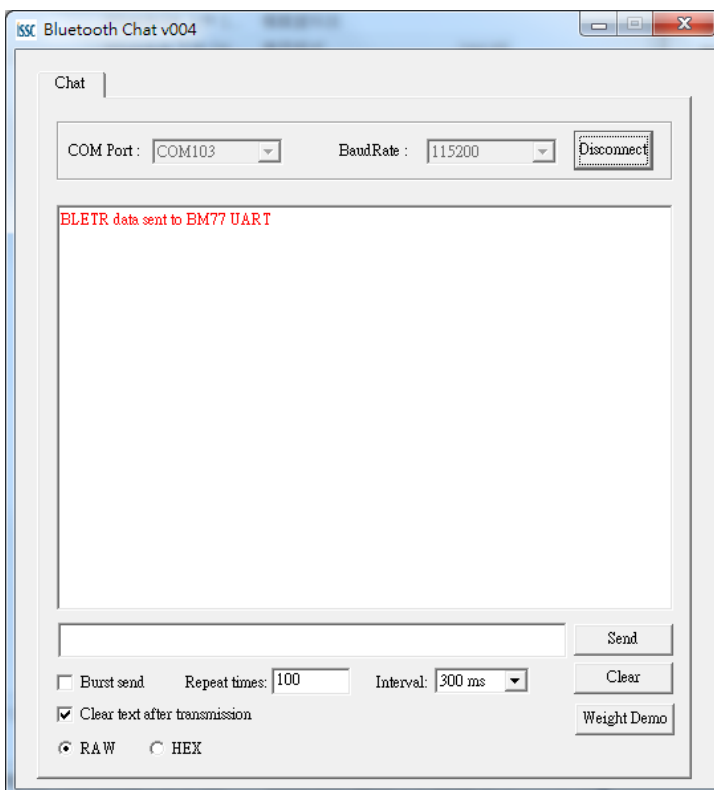

Timer Feature

In addition to Raw mode (ASCII) the Transparent data view also has Timer and Echo features. The Timer feature allows the BLETR to send a repeated test pattern to BT CHAT for test throughput and data transfer test.

An example of the “Timer” test feature is shown below.

BLETR configured to transmit a 100 test blocks of 20 characters, every 1000ms. BT CHAT tool receives the test pattern data and displays it in red text. The line break indicates a Bluetooth Low Energy packet break, meaning a transmitted test block was fragmented into multiple BLE packets.

Clicking the “Start” button initiates the data transfer.

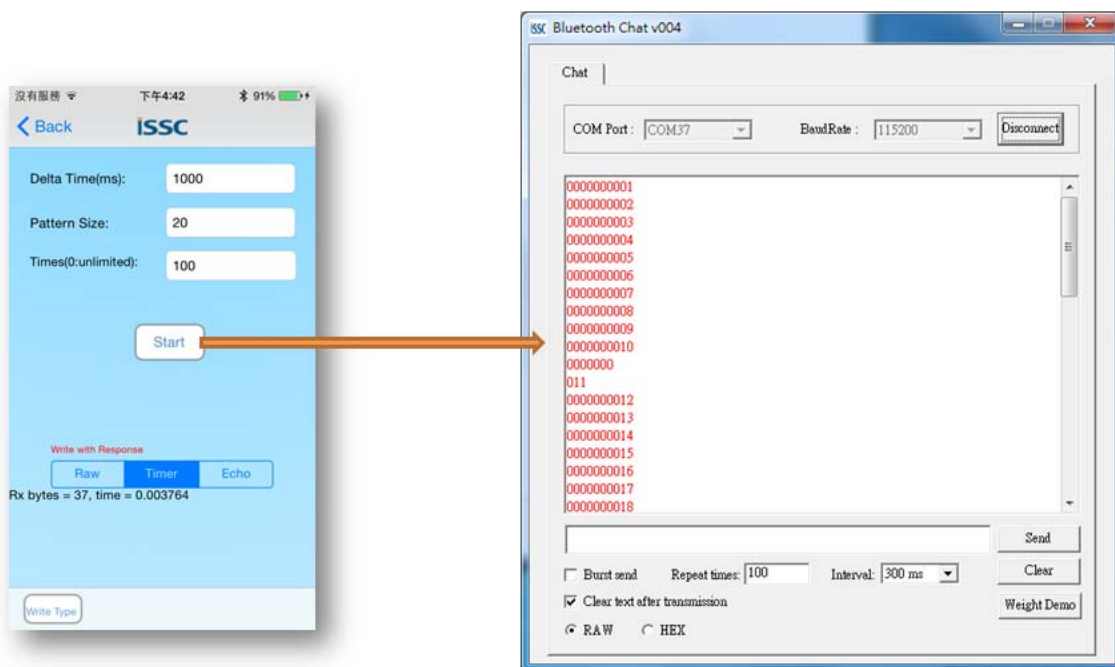

Tx File Feature

Another test feature similar to the Timer feature is the “TX File” transfer. The “TX File” functions transfers files, which as embedded in the BLETR APP, to the BM77. The steps to use this feature are as follows:

- a. Click the “TX File” button to open a dialog with list of file sizes to transmit
- b. Select the file size to send
- c. Observe the file received on BT Chat.

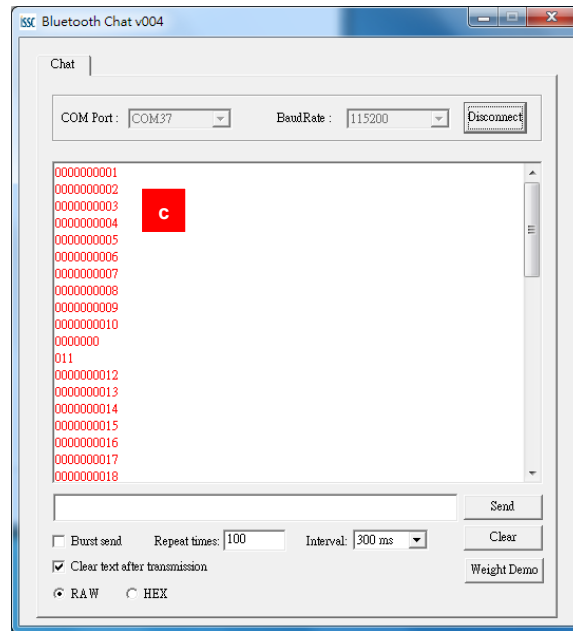
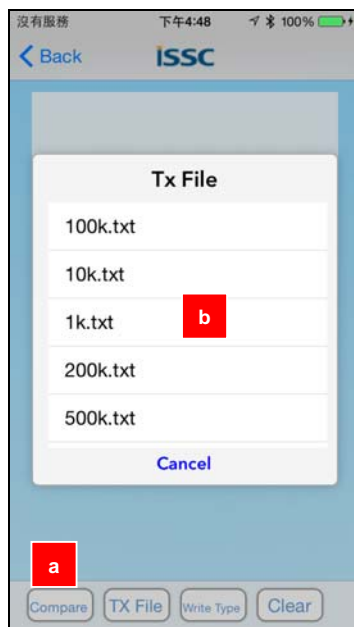

Echo Feature

The Echo feature is an optional function for the Transparent data view. When Echo is enabled, any data received by BLETR is echoed back to sender.

The example below show text sent from BTCHAT being echoed to BLETR when the Echo mode is enabled.

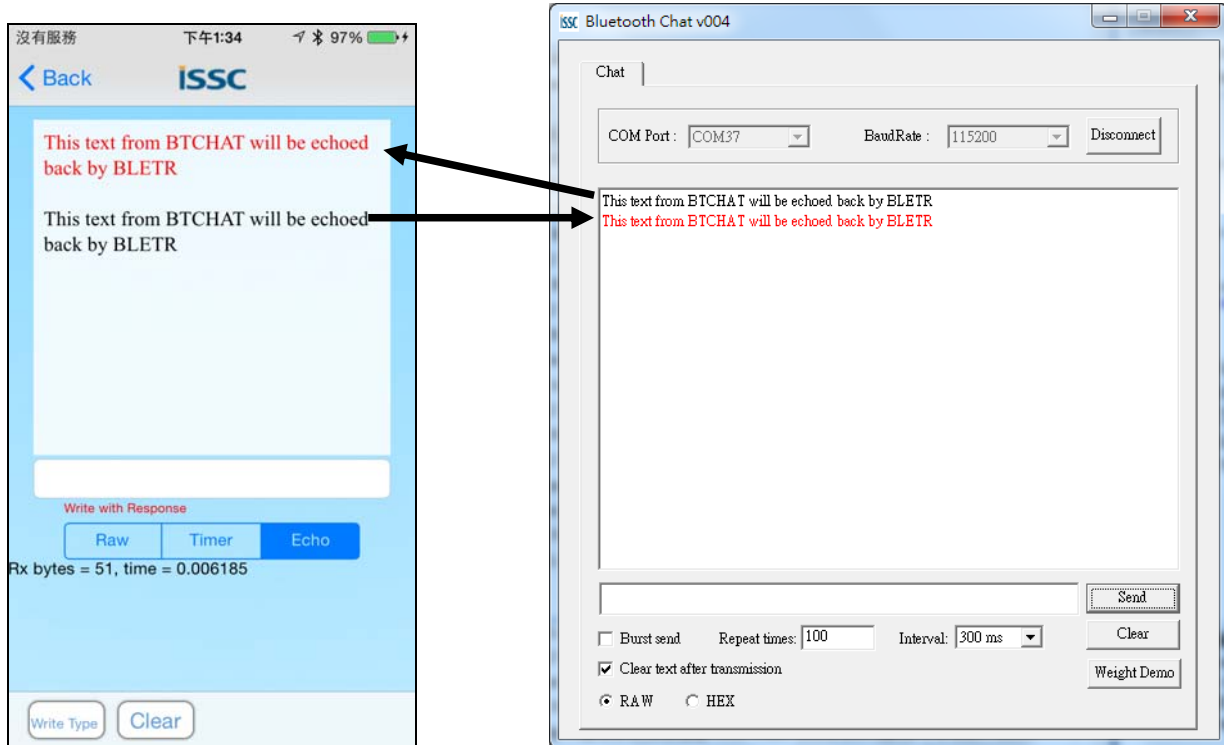

Device Information Feature

The Device Information view displays the characteristics associated with Device Information service. The Device Information service is available to all Bluetooth 4.0 low energy host that access the BM77EVB. It exposes the information identifying information about the BM77 peripheral device. These values can be programmed using a configuration tool described in the application note.



Proprietary (Configuration) Feature

The Proprietary view demonstrates the capability to change Bluetooth Low Energy connection parameters remotely via BLETR application. **These parameters only affect Bluetooth Low Energy connections.**

1. Max Interval: time (ms) between communication interval between BM77 and Bluetooth LE Central device.
2. Connection Timeout: time (ms) between communication events before a connections considered lost
3. Latency: Number of connection events peripheral (BM77) is allowed to skip
4. Bluetooth LE Name used to advertise Peripheral name to scanning Central devices. Enter new name in text box and click "Change Name" to invoke change.

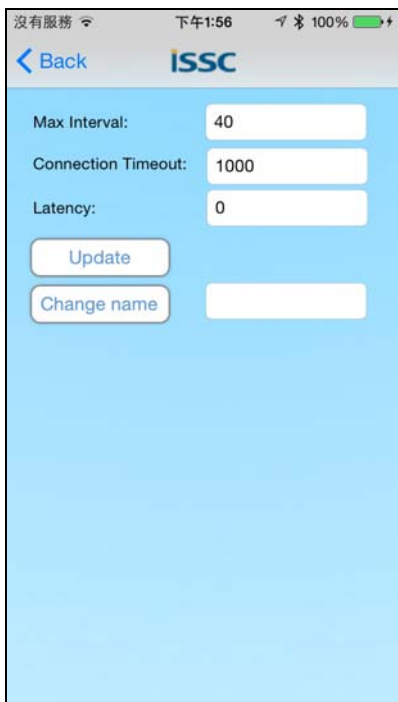

The screenshot shows a mobile application interface with a light blue background. At the top, there is a status bar with the text "沒有服務" (No service), a signal strength icon, the time "下午1:56", a battery icon, and "100%". Below the status bar is a navigation bar with a blue "< Back" button and the "ISSC" logo. The main content area contains three rows of configuration options, each with a label and a text input field: "Max Interval:" with the value "40", "Connection Timeout:" with the value "1000", and "Latency:" with the value "0". Below these fields are two buttons: "Update" and "Change name". The "Change name" button is positioned to the left of an empty text input field.

5. Appendix A: BM77SPP03 Module PIN Assignment

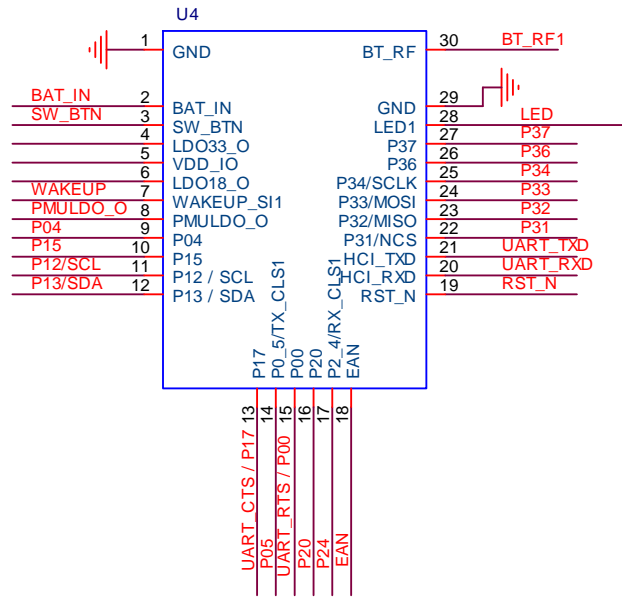

BM77 Module PIN Define

| P/N | I/O | Name | Description |
|-----|-----|----------|--|
| 1 | P | GND | Ground |
| 2 | P | BAT_IN | 4.2~3.3V Power input |
| 3 | I | SW_BTN | Input for software button. H: Power On L: Power Off |
| 4 | P | LDO33_O | 3V3 LDO output |
| 5 | P | VDD_IO | Main power supply |
| 6 | P | LDO18_O | LDO18 output |
| 7 | I | WAKEUP | Wakeup BM77 from Shutdown State. (Low Active) It is only valid while BM77 into Shutdown State. |
| 8 | P | PMULDO_O | Output of PMULDO |
| 9 | O | P04 | UART_TX_IND: H: BM77 indicate UART data will be transmitted out after a certain timing. (Setting by EEPROM, default 5ms) L: Otherwise. STATUS_IND_2: BM77 State indication , refer to P15 |

| P/N | I/O | Name | Description |
|-----|------|------------|--|
| 10 | O | P15 | STATUS_IND: Bluetooth link status indication P15/P04: HH → Power default value and Shutdown State. P15/P04: HL → Access State. P15/P04: LL → Link State w/o UART_TXD. P15/P04: LH → Link State with UART_TXD. |
| 11 | N/A | P12/ SCL | I2C_SCL, Reserved |
| 12 | N/A | P13/ SDA | I2C_SDA, Reserved |
| 13 | I | P17 | - UART_CTS: - Configurable Functional GPIO |
| 14 | I/O | P05 | Configurable Functional GPIO |
| 15 | O | P00 | - UART_RTS - Configurable Functional GPIO |
| 16 | I | P20 | System configuration, refer to P2_4. (No drive under APP Mode) |
| 17 | I | P24 | Boot mode selection. (No drive under APP Mode) P2_0/ P2_4: HH → Application LL → Boot mode LH → HCI UART mode for testing and system configuration. |
| 18 | I | EAN | ROM/Flash selection. (No drive under APP Mode) H: ROM code; L: Flash code |
| 19 | I | RST_N | External reset input (Low Active), Clock period 62.5n at least |
| 20 | I | HCI_RXD | UART_RXD |
| 21 | O | HCI_TXD | UART_TXD |
| 22 | I/O | P31 | Configurable Functional GPIO |
| 23 | I | P32 | Configurable Functional GPIO |
| 24 | I | P33 | Configurable Functional GPIO |
| 25 | I | P34 | Configurable Functional GPIO |
| 26 | O | P36 | Reserved |
| 27 | I/O | P37 | Configurable Functional GPIO |
| 28 | O | LED1 | LED1 driver |
| 29 | P | GND | Ground |
| 30 | RI/O | BT_RF | RF Port |

6. Appendix B: BM77EVB Schematic

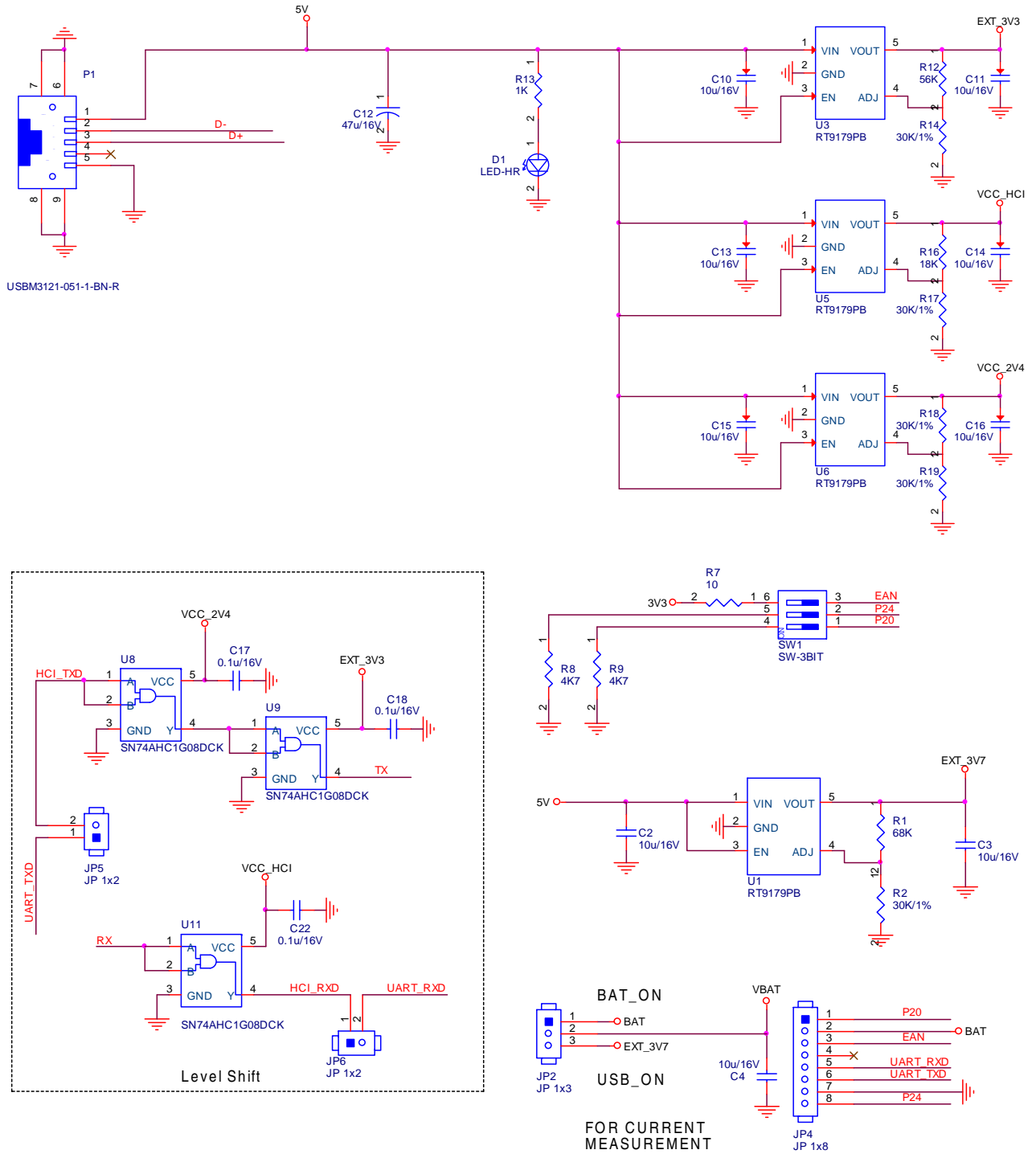

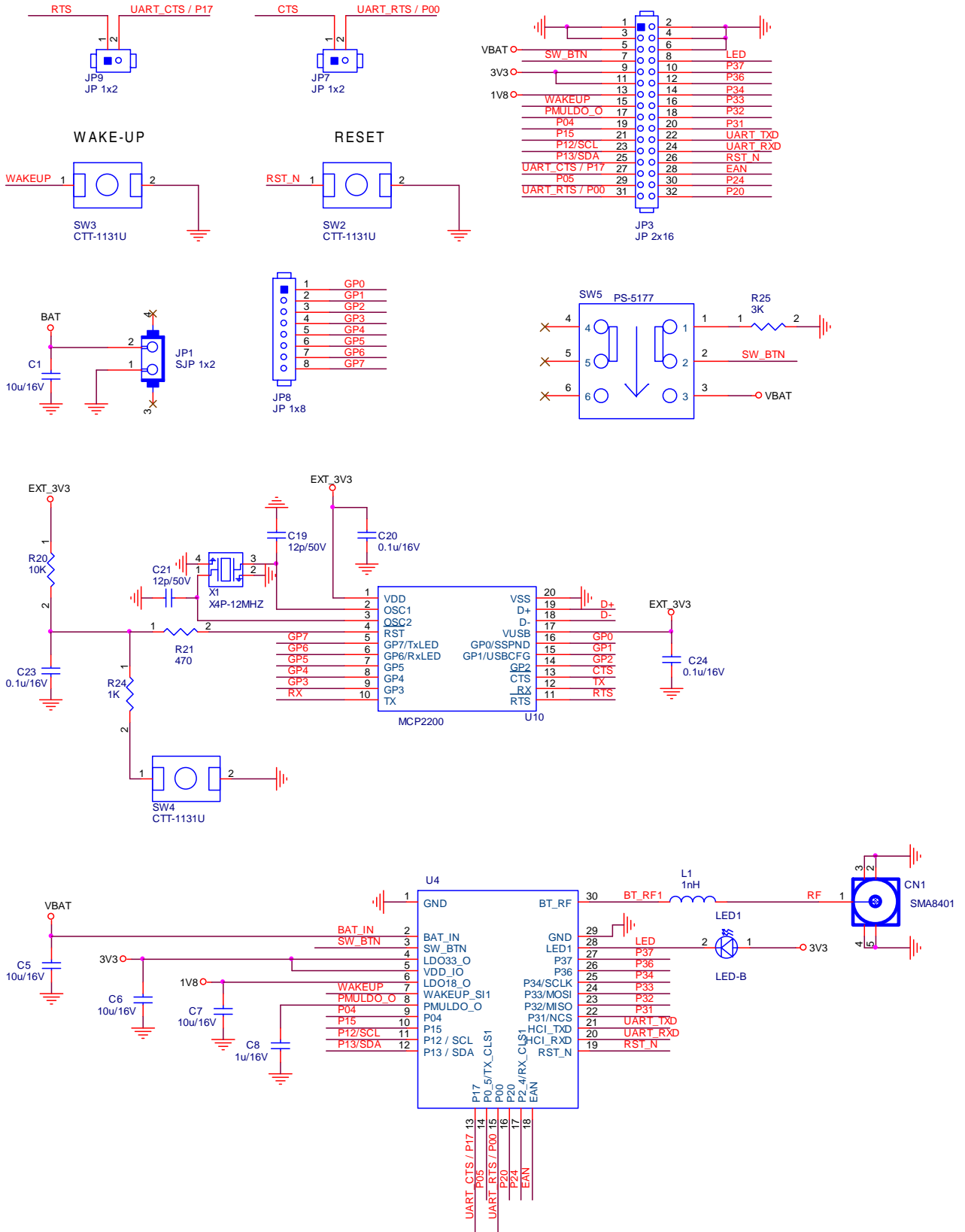

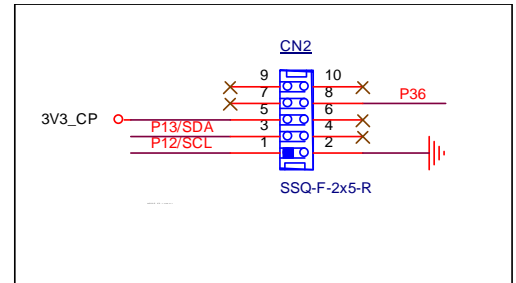
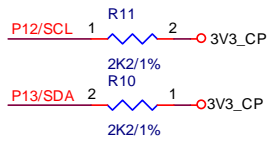
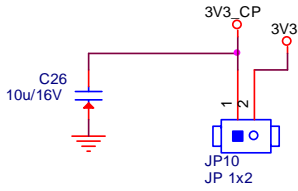
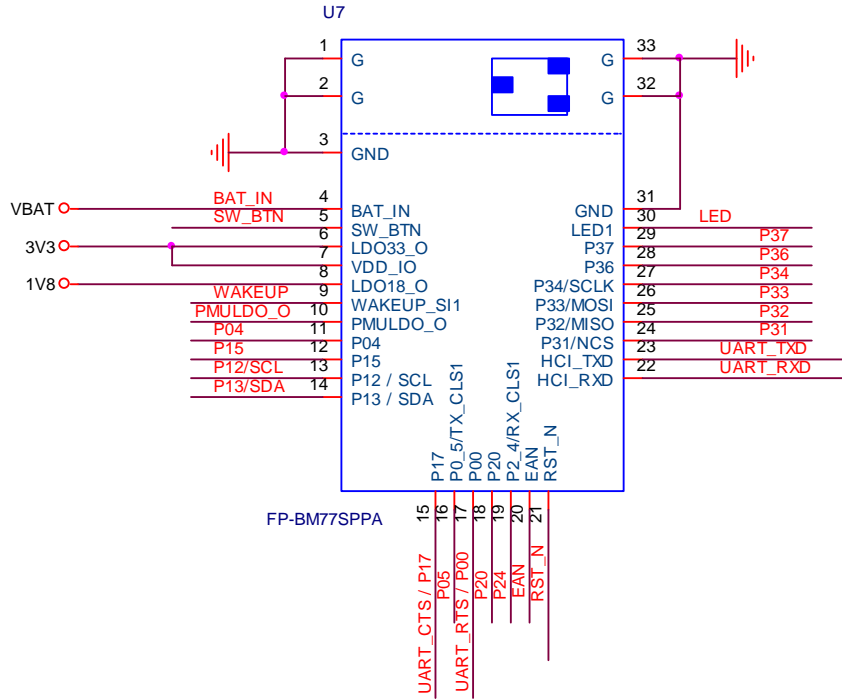

7. Appendix C: Q & A

1. Is the BM77 Module Data Sheet available?

Yes. Contact your Microchip representative to request additional information about the BM77 module.

2. When I connect the BM77EVB to the host PC the COM port does not appear?

Try resetting the MCP2200 by pressing SW4.

3. What is maximum supported baud rate of BM77 UART?

The maximum baud rate is 921600 with used with of 16MHz crystal.

4. How do you change Bluetooth parameters such name, Device Info, COD, rate, inquiry and page scan windows?

The configuration settings are accessed using a "UI Tool" software utility. Contact your Microchip representative to request additional configuration tools and documentation for BM77.

5. What is default security mode for SPP?

SSP/It Just Works

6. Is there an Android BTLE demonstration application?

At this time Android support for dual-mode Bluetooth devices, such as the BM77, is limited to Bluetooth classic SPP data service.

7. Is the source code for iOS and Android APP available

Contact your Microchip representative to request the source code packages for the smartphone Apps.

8. Appendix D: Revision History

| Version | Date | History |
|---------|------------|--|
| 0.1 | 2012/8/27 | Draft Version |
| 0.2 | 2014/06/12 | Modify connect with Ipad air tool |
| 0.3 | 2014/07/30 | Modify layout |
| 0.4 | 2014/10/03 | Added screen shots for Smartphone Apps, revisions for MCHP BM77EVB release |