

Device Features

- +31.8 dBm Input IP3 @3.5G
- 9.0 dB Conversion Loss @3.5G
- Integrated LO Driver
- -2 to +2 dBm LO drive level
- Available 3.3 V to 5 V single voltage
- MSL 3, TDFN-8L 3x3, Green / RoHS2 compliant
- ESD HBM Class 1A

Package Type



Product Description

The BM351 is a high linearity and dynamic covering range from 2.5 GHz to 6.0 GHz on 3.3 V to 5 V with a passive GaAs FET converter and two stage LO driver. This is packaged in a plastic surface mountable TDFN-8Lead 3x3 with Lead-free / Green / RoHS2 compliant. Typical Input IP3 and Conversion loss are 32 dBm and 8.8dB, respectively. All devices are 100% RF/DC screened.

Application Circuit

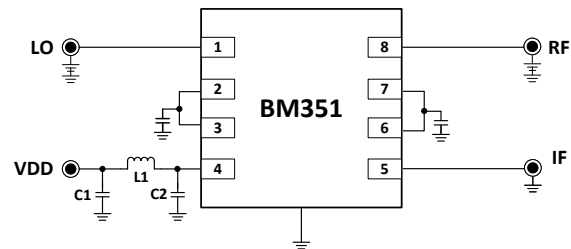

IF Frequency	BOM	Value
100~500 MHz	C1	N/C
	C2	1nF
	L1	27nH

Applications

- Base station /Repeaters Infrastructure/Small Cell
- Commercial/Industrial/Military wireless system
- 5G/LTE / WCDMA /CDMA Wireless Infrastructure
- MMD & wireless LAN

Functional Block Diagram

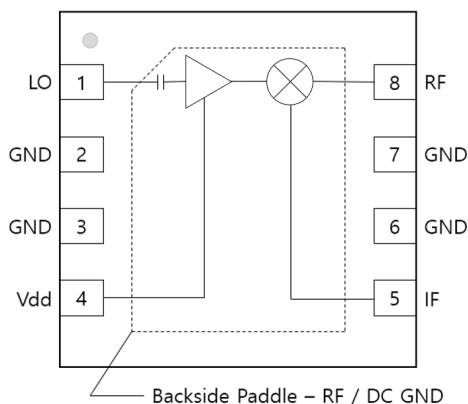

Recommended Operating Conditions

Parameter	Min.	Typical	Max.	Unit
Bandwidth	2500		6000	MHz
I_d @ (Vd = 5.0V)	75	85	95	mA
I_d @ (Vd = 3.3V)	55	62	70	mA
R_{TH}		99		°C/W
Operating Case Temperature	-40		+85	°C

Typical Performance¹

Test condition _ Measured on BeRex E/B at 25°C, 50ohm system, Vdd=5V Ids=85mA

Parameter	Min	Typ	Max	Min	Typ	Max	Min	Typ	Max	Min	Typ	Max	Units
RF Frequency Range	2500~2700			3300~3700			4600~4800			5500~6000			MHz
LO Frequency Range	2300~2650			2800~3600			4100~4700			5000~5900			MHz
IF Frequency Range	50~200			50~700			50~700			50~700			MHz
SSB Conversion Loss		8.8			8.9			9.2			9.7		dB
Input IP3 ²		26.9			28.8			37.4			29.5		dBm
LO Leakage RF Port		-11.1			0.7			5.5			-1.3		dBm
LO Leakage IF Port		-20.9			-22.9			-15.0			-15.6		dBm
RF-IF Isolation		-31.2			-37.9			-31.5			-29.8		dB
RF Return Loss		-7.2			-22.0			-14.1			-13.4		dB
IF Return Loss		-7.6			-4.4			-5.6			-19.0		dB
Input P1dB		17.1			22.1			24.1			19.7		dBm
LO Drive Level	-2	0	2	-2	0	2	-2	0	2	-2	0	2	dBm

Test condition _ Measured on BeRex E/B at 25°C, 50ohm system, Vdd=3.3V Ids= 62mA

Parameter	Min	Typ	Max	Min	Typ	Max	Min	Typ	Max	Min	Typ	Max	Units
RF Frequency Range	2500~2700			3300~3700			4600~4800			5500~6000			MHz
LO Frequency Range	2300~2650			2800~3600			4100~4700			5000~5900			MHz
IF Frequency Range	50~200			50~700			50~700			50~700			MHz
SSB Conversion Loss		8.5			8.5			8.7			11.2		dB
Input IP3 ²		27.9			25.6			36.1			24.1		dBm
LO Leakage RF Port		-15.1			-3.3			1.5			-7.3		dBm
LO Leakage IF Port		-22.9			-24.0			-17.2			-17.4		dBm
RF-IF Isolation		-31.2			-38.6			-32.1			-30.7		dB
RF Return Loss		-7.4			-20.2			-12.3			-12.1		dB
IF Return Loss		-5.7			-5.7			-6.7			-17.2		dB
Input P1dB		15.3			19.6			21.1			15.6		dBm
LO Drive Level	-2	0	2	-2	0	2	-2	0	2	-2	0	2	dBm

¹ Specifications show on 0dBm-LO driven power and 200 MHz-IF frequency in a down converting configuration with Low-side LO.

² IIP3 is measured on two tone with RF in power 0dBm/ tone, F2-F1 = 1 MHz.

Absolute Maximum Ratings

Parameter	Rating	Unit
Storage Temperature	-55 to +155	°C
Junction Temperature	195	°C
Supply Voltage	7	V
LO Power	10	dBm
Input RF/IF Power	25	dBm

Operation of this device above any of these parameters may result in permanent damage.

Typical Test Data : 5V, RF to IF Converting

Test condition : Measured on BeRex E/B at 25°C, 50ohm system, Vdd=5V, I_{ds}=85mA , Down converting

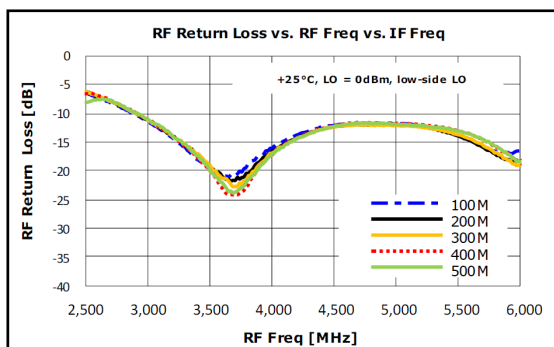
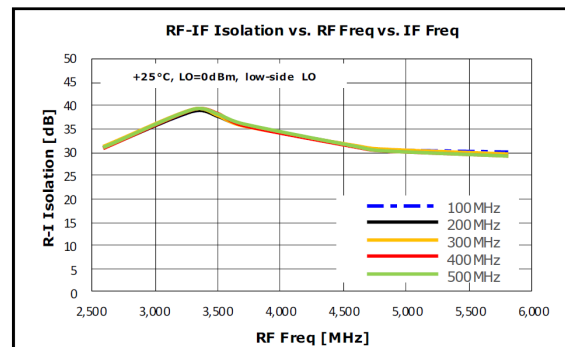
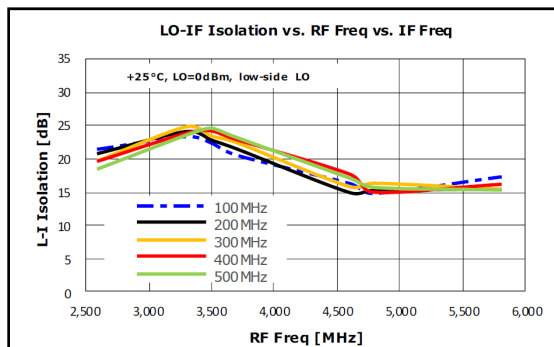
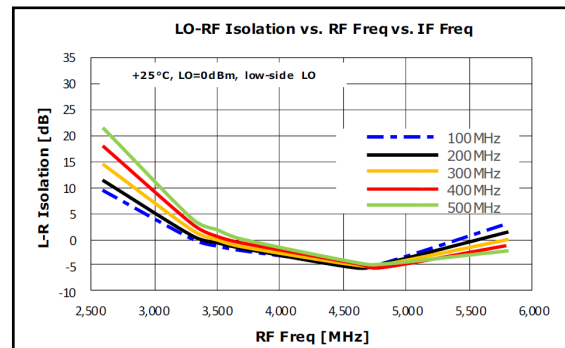
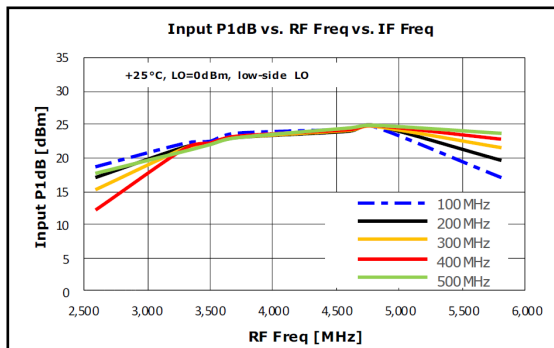
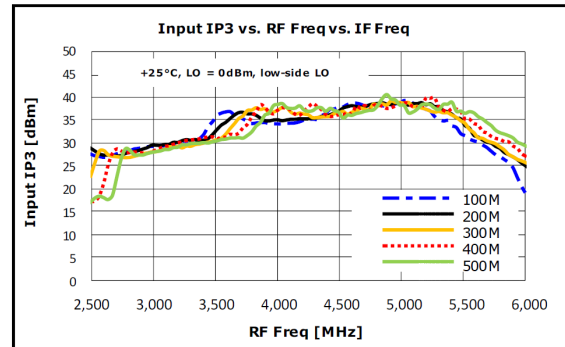
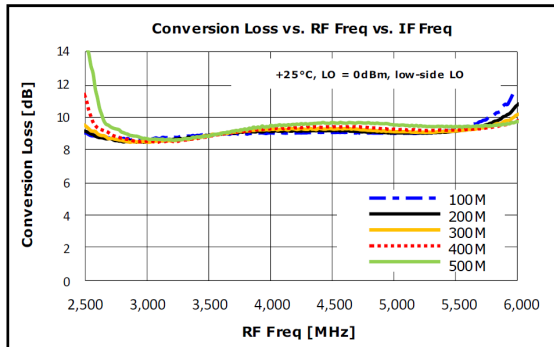

Typical Test Data : 5V, RF to IF Converting

Test condition : Measured on BeRex E/B at 25°C, 50ohm system, Vdd=5V, I_{ds}=85mA , Down converting

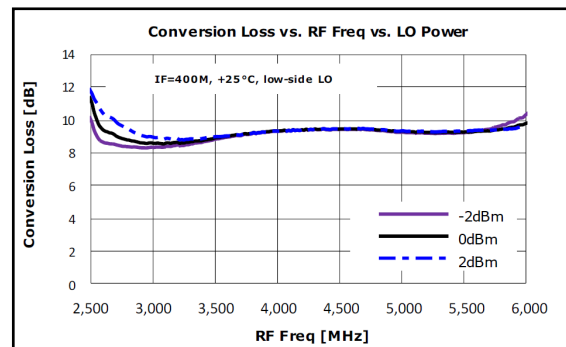
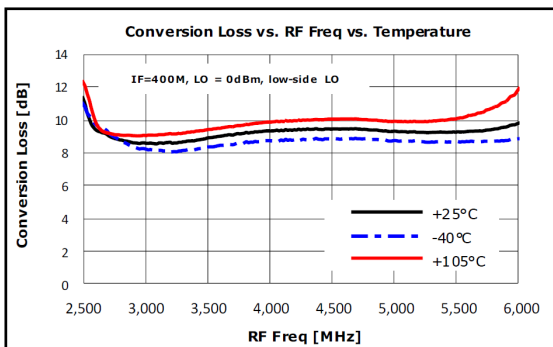
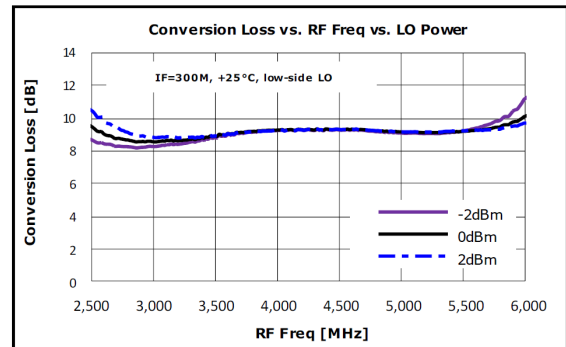
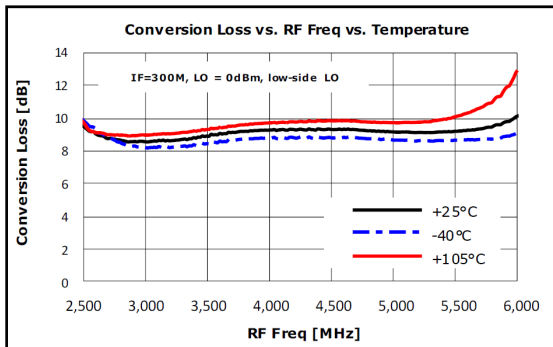
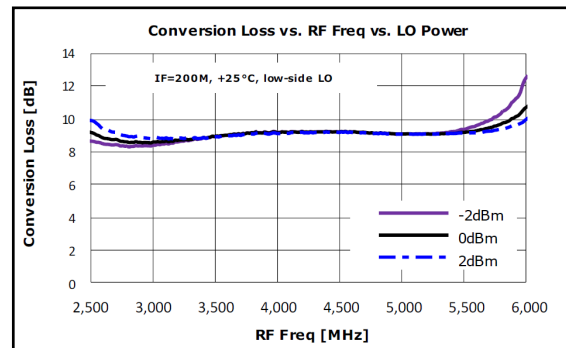
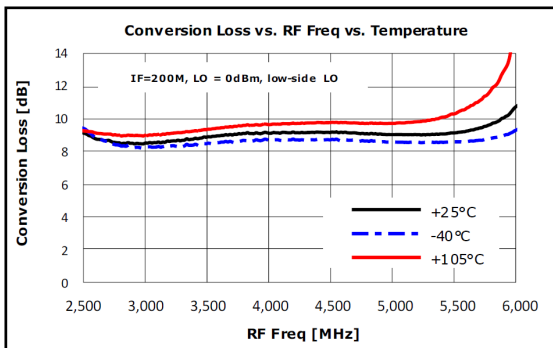
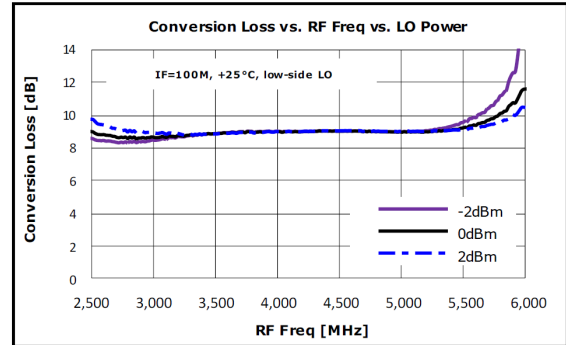
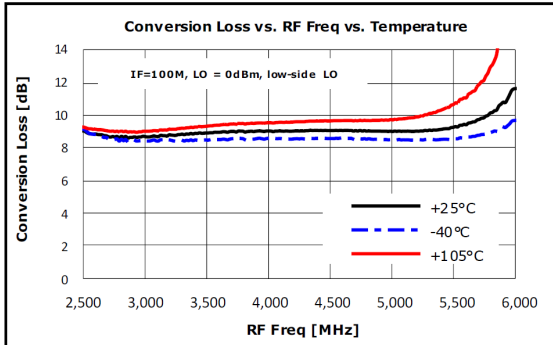

Typical Test Data : 5V, RF to IF Converting

Test condition : Measured on BeRex E/B at 25°C, 50ohm system, Vdd=5V, I_{ds}=85mA , Down converting

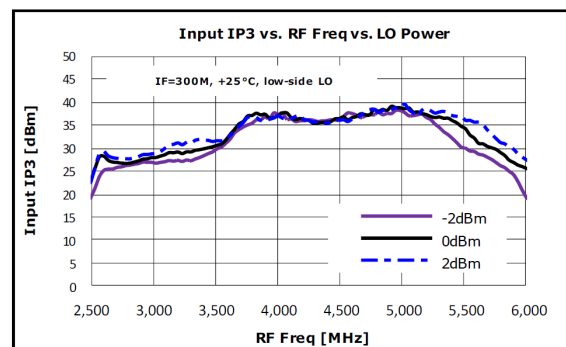
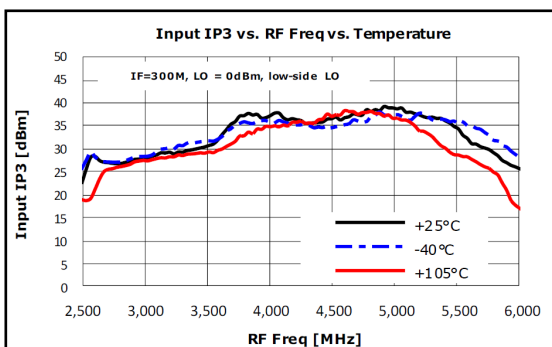
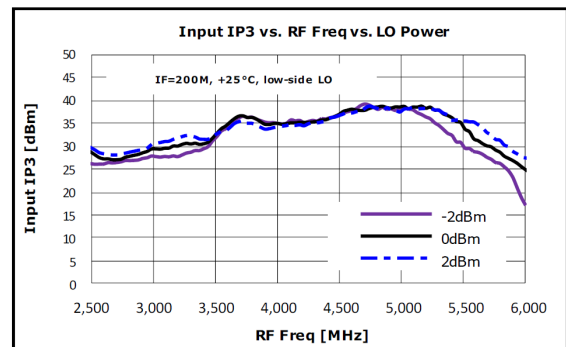
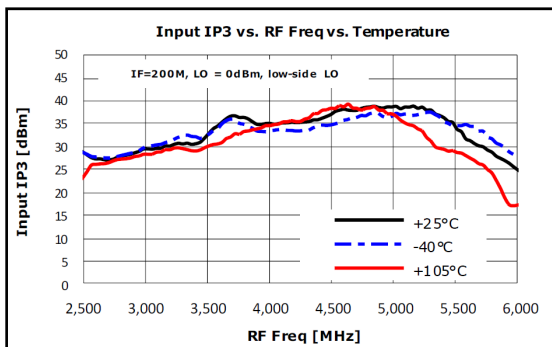
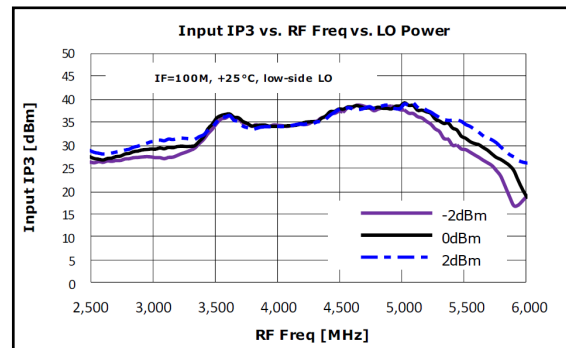
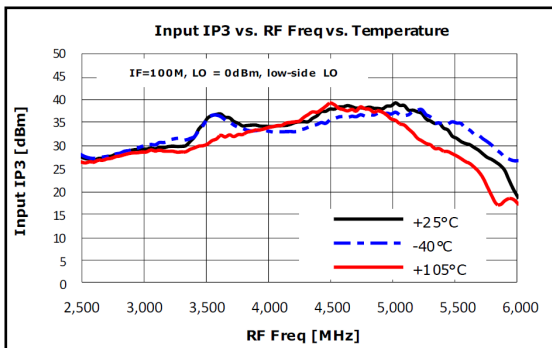
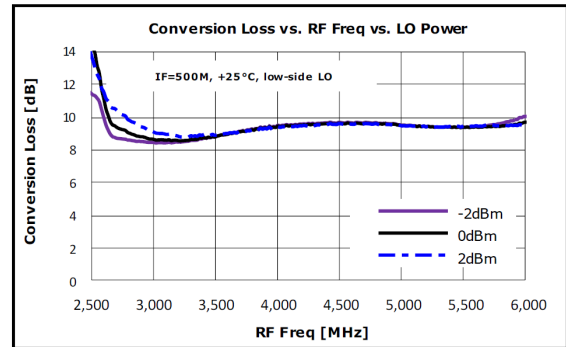
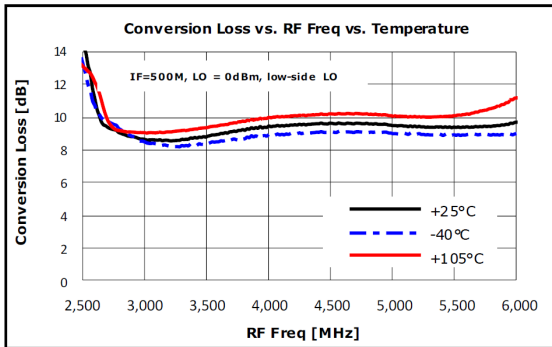

Typical Test Data : 5V, RF to IF Converting

Test condition : Measured on BeRex E/B at 25°C, 50ohm system, Vdd=5V, I_{ds}=85mA , Down converting

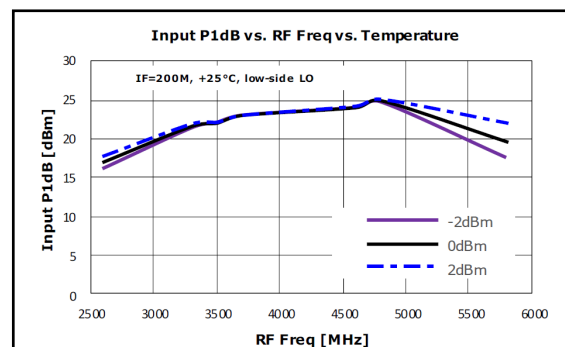
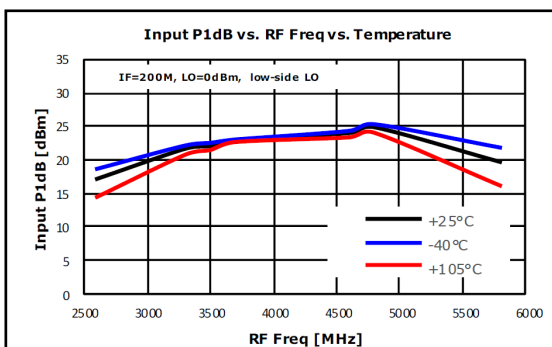
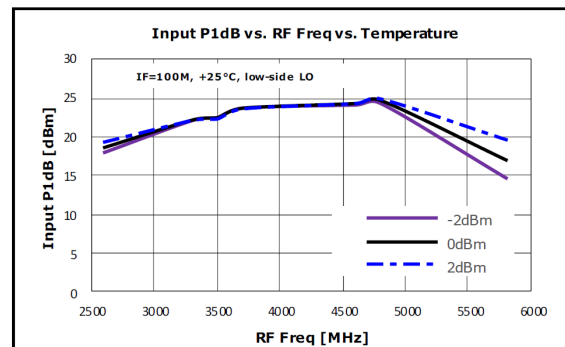
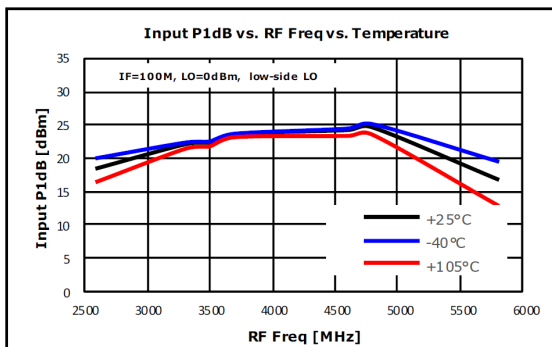
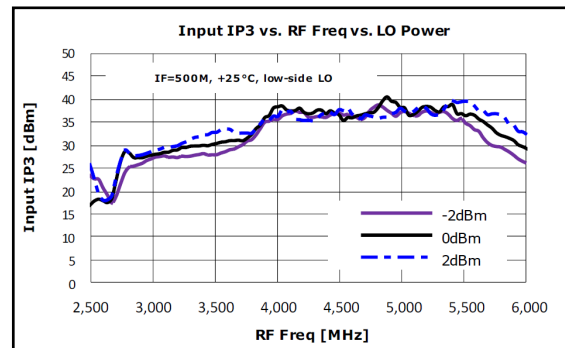
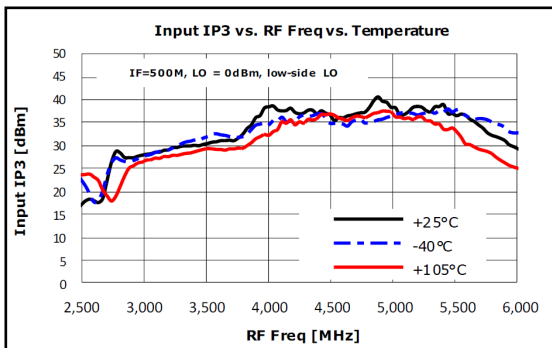
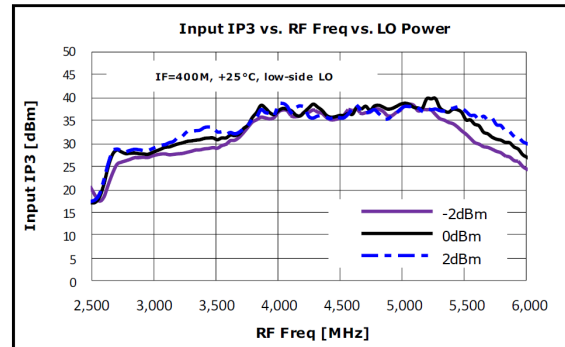
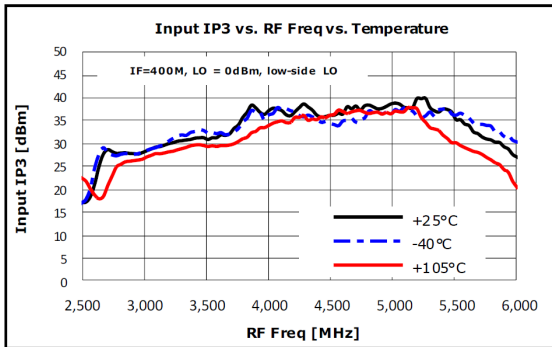

Typical Test Data : 5V, RF to IF Converting

Test condition : Measured on BeRex E/B at 25°C, 50ohm system, Vdd=5V, I_{ds}=85mA , Down converting

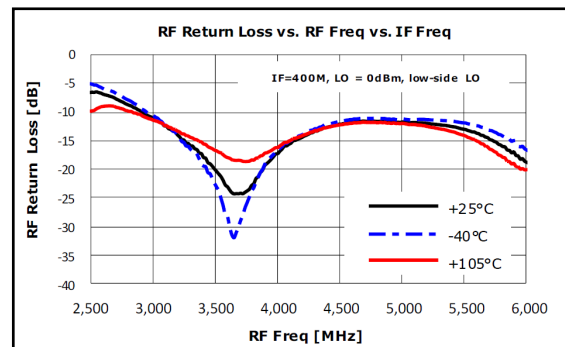
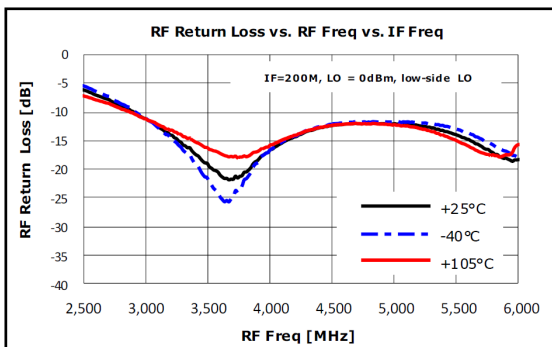
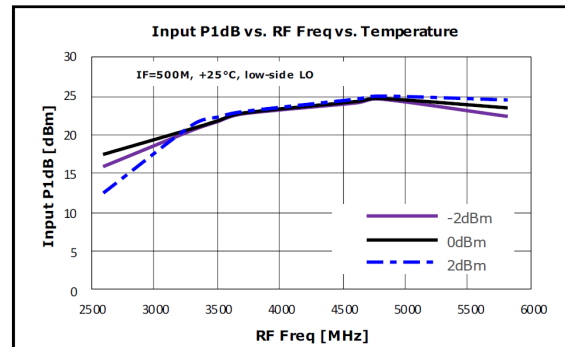
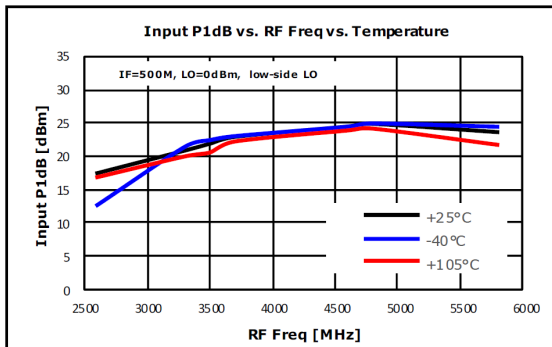
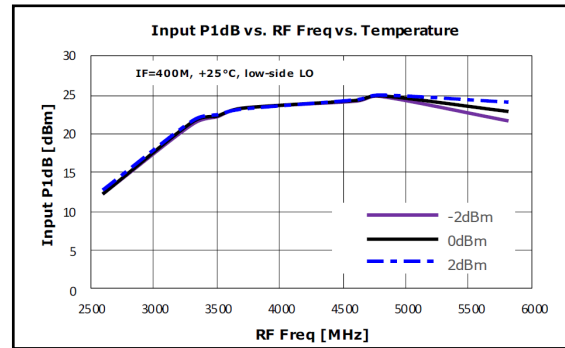
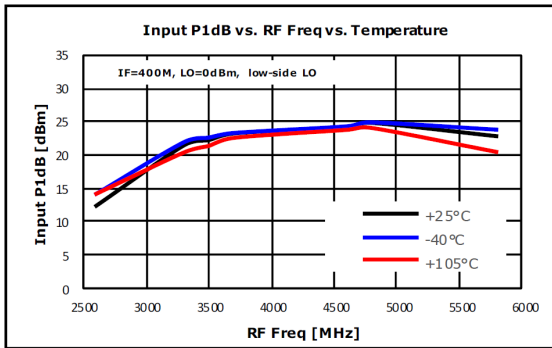
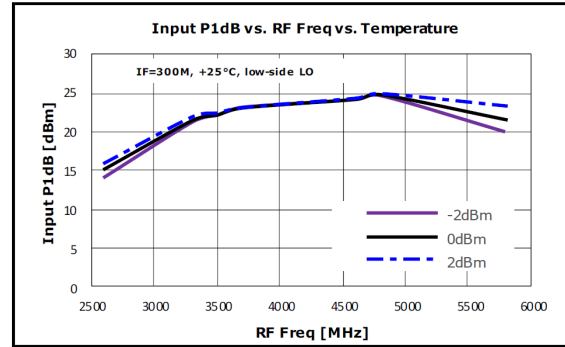
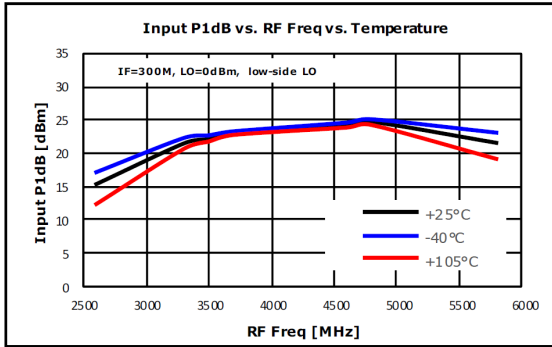

Typical Test Data : 5V, IF to RF Converting

Test condition : Measured on BeRex E/B at 25°C, 50ohm system, Vdd=5V, I_{ds}=85mA , Up converting

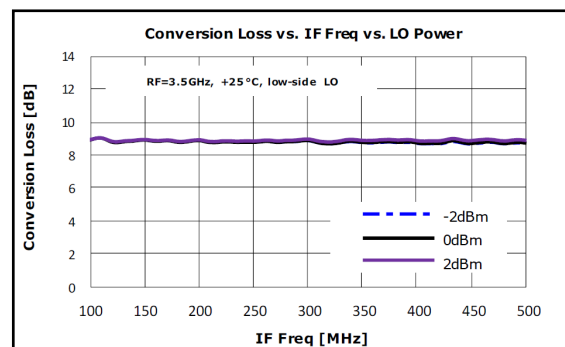
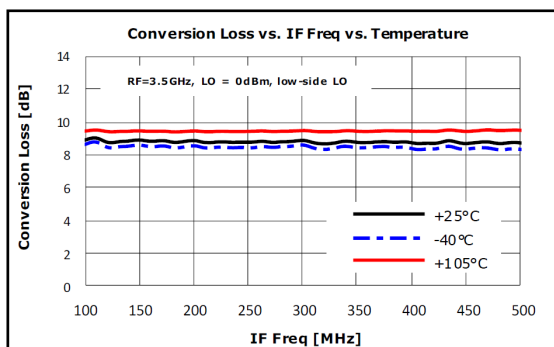
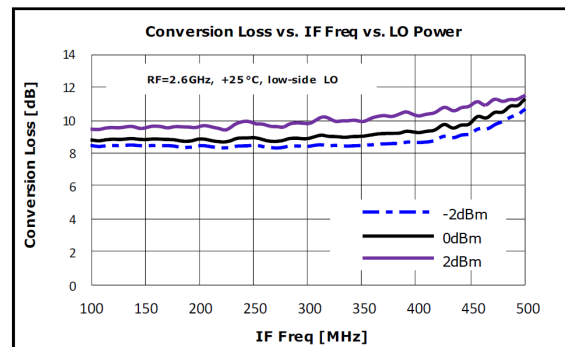
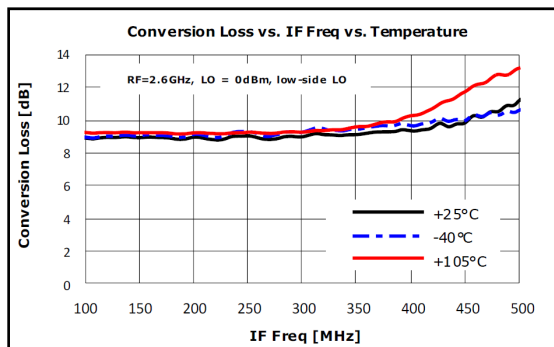
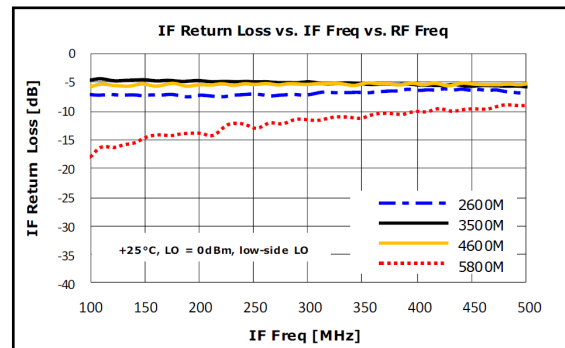
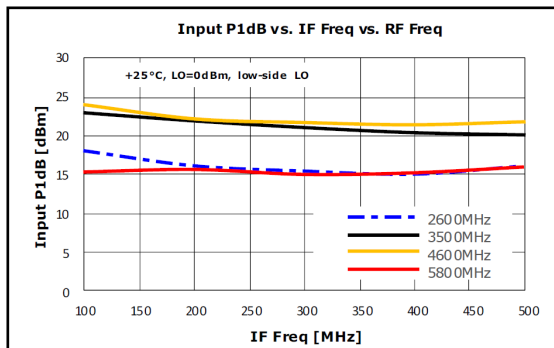
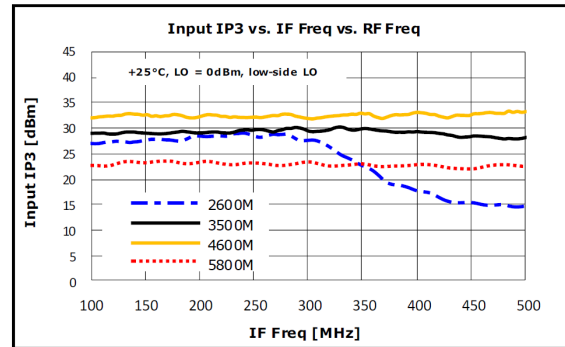
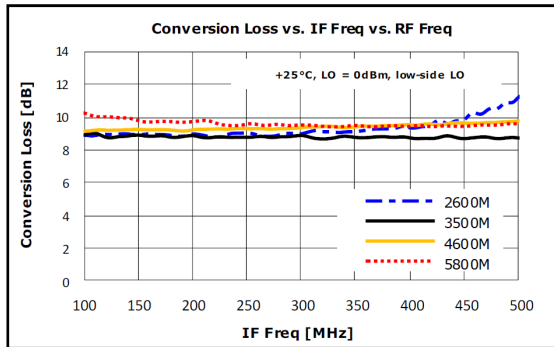

Typical Test Data : 5V, IF to RF Converting

Test condition : Measured on BeRex E/B at 25°C, 50ohm system, Vdd=5V, I_{ds}=85mA , Up converting

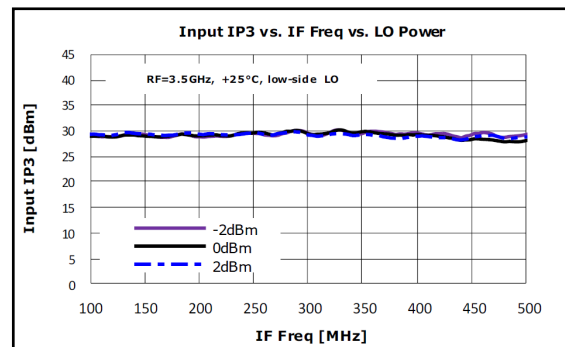
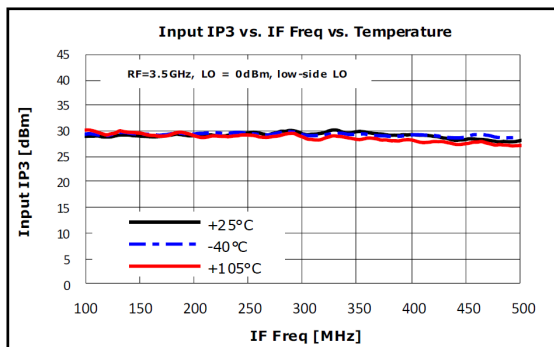
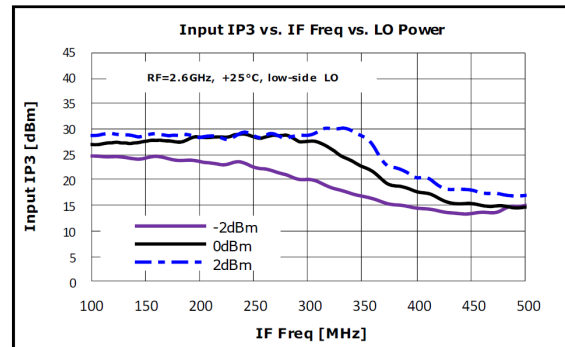
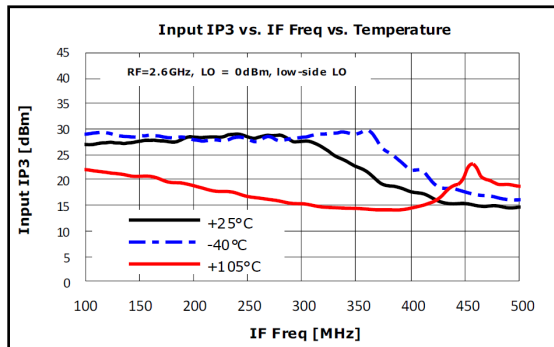
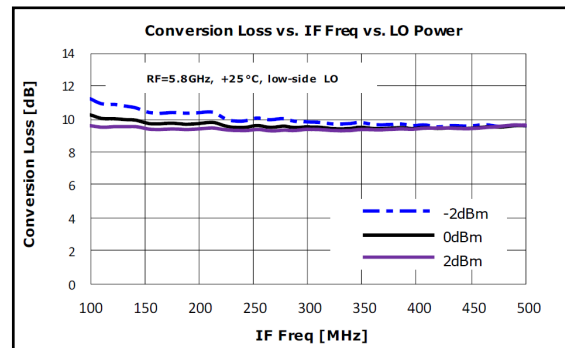
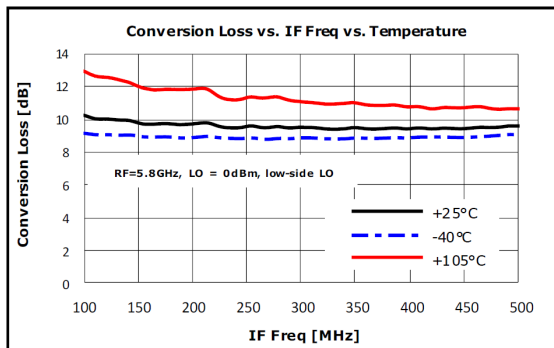
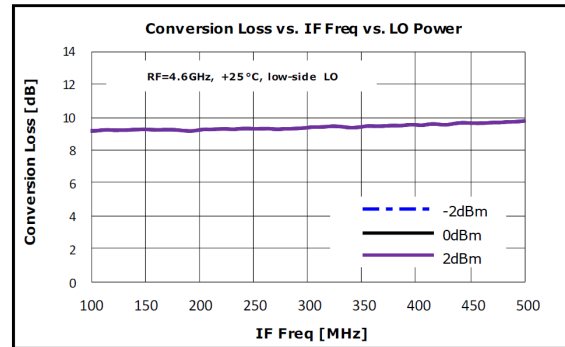
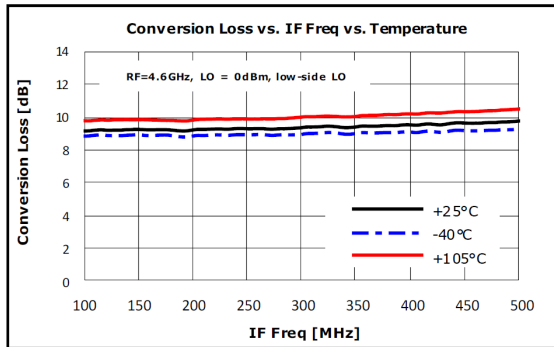

Typical Test Data : 5V, IF to RF Converting

Test condition : Measured on BeRex E/B at 25°C, 50ohm system, Vdd=5V, I_{ds}=85mA , Up converting

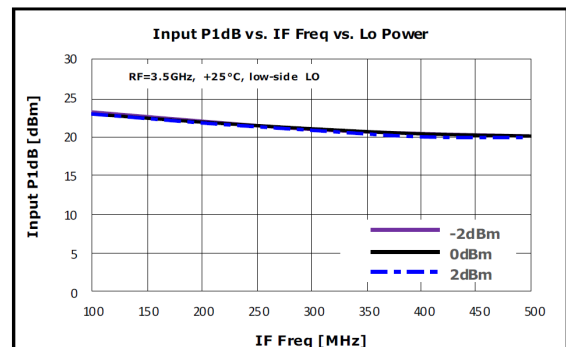
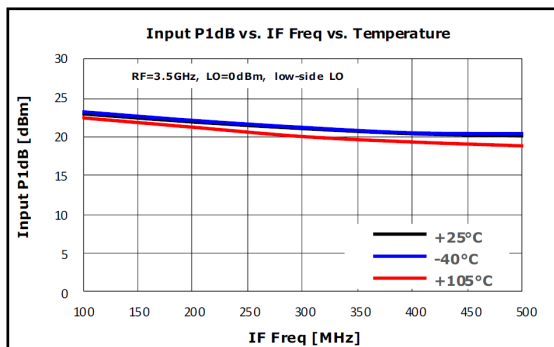
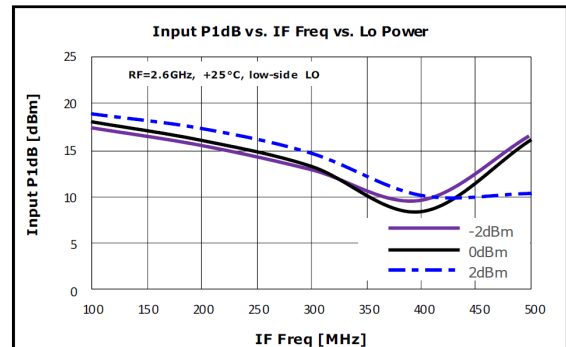
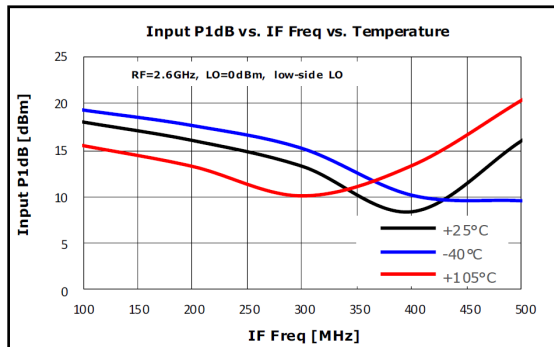
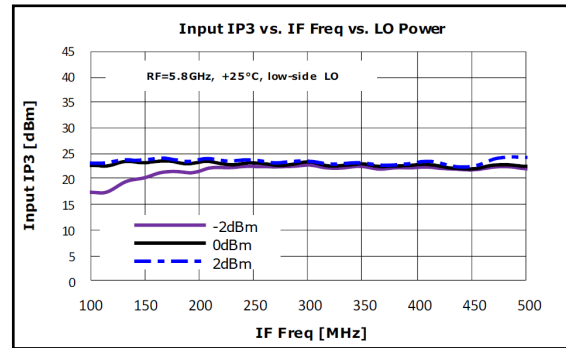
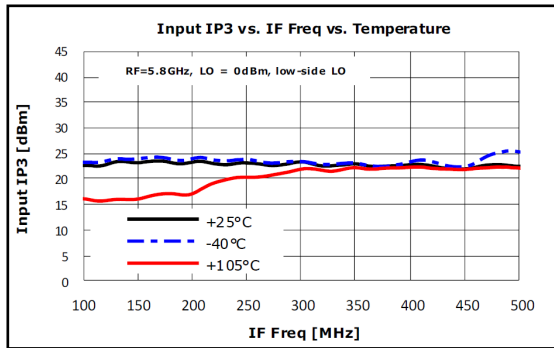
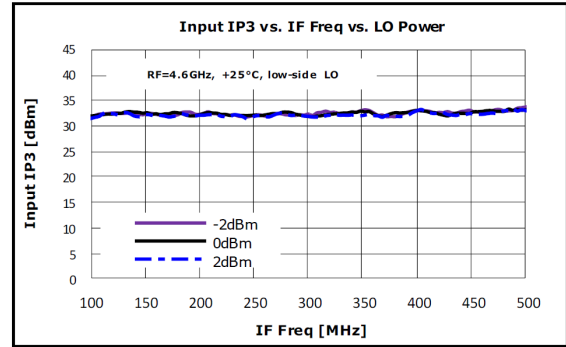
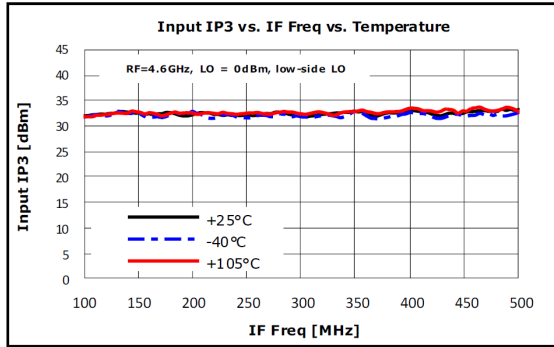

Typical Test Data : 5V, IF to RF Converting

Test condition : Measured on BeRex E/B at 25°C, 50ohm system, Vdd=5V, I_{ds}=85mA , Up converting

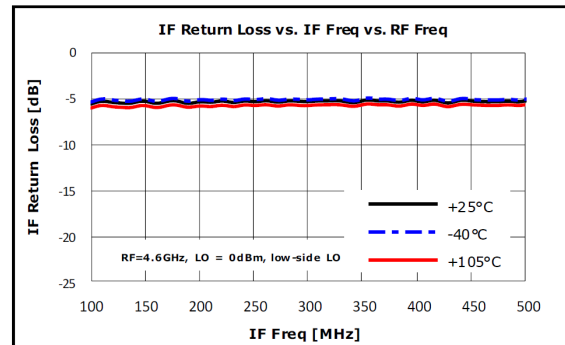
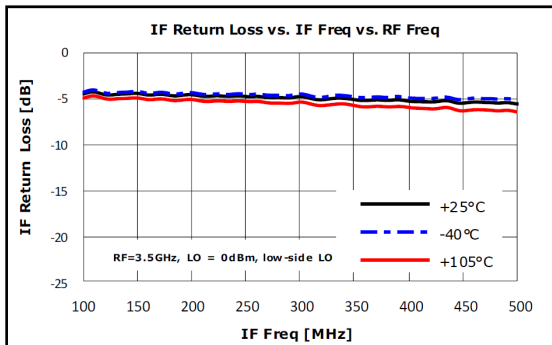
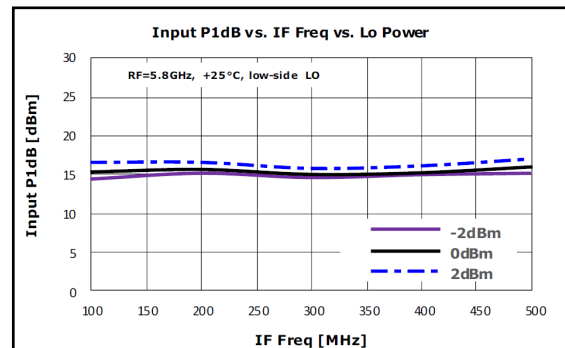
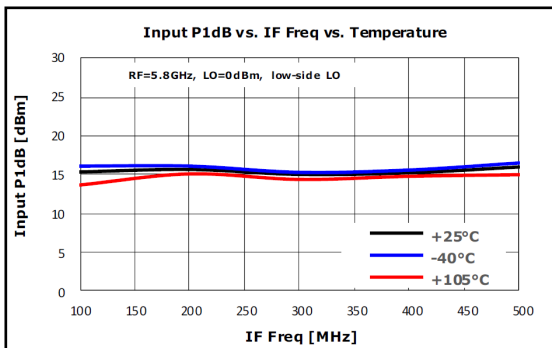
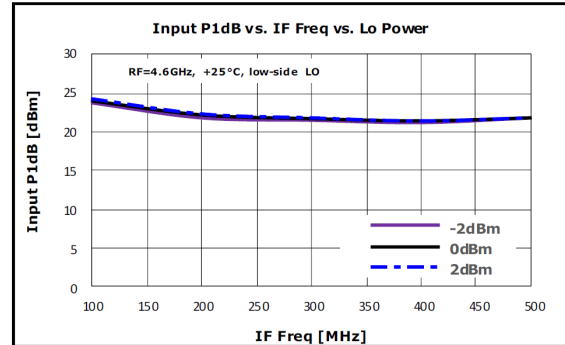
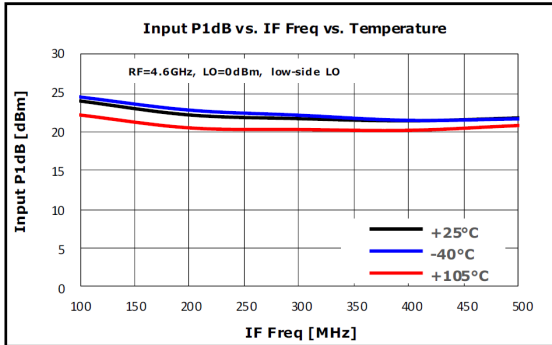

Typical Test Data : 3.3V, RF to IF Converting

Test condition : Measured on BeRex E/B at 25°C, 50ohm system, Vdd=3.3V, I_{ds}=62mA , Down converting

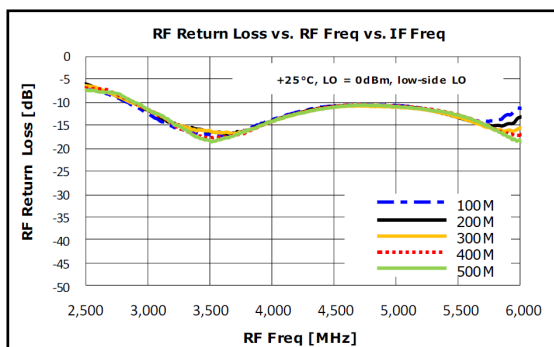
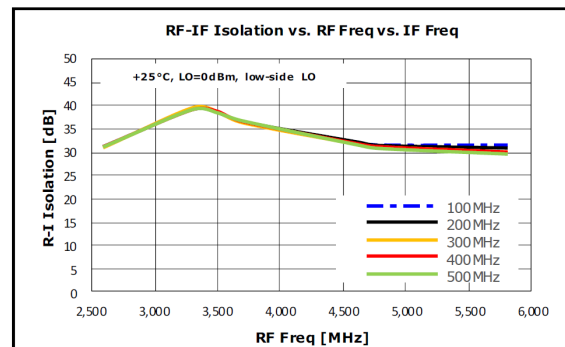
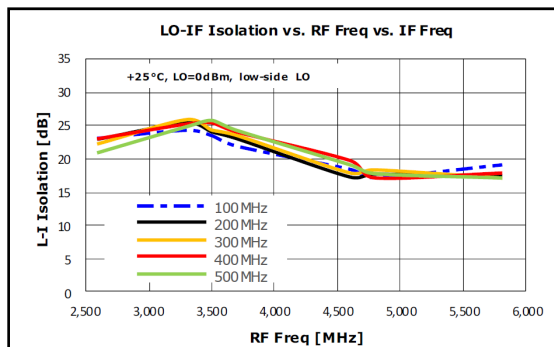
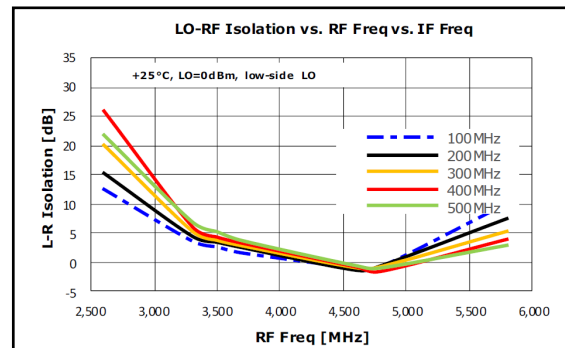
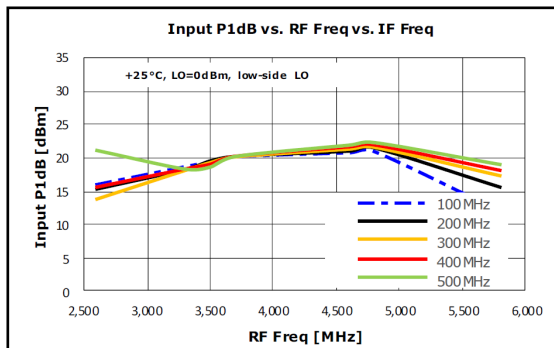
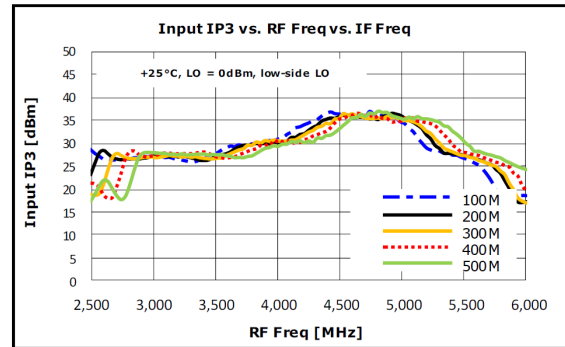
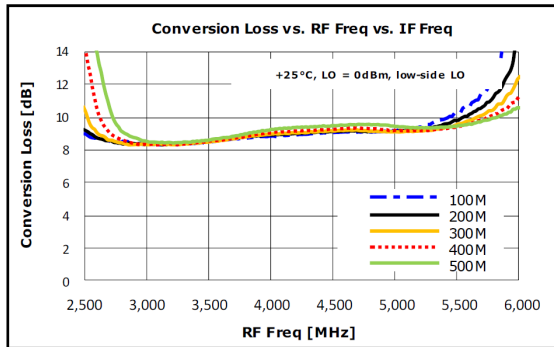

Typical Test Data : 3.3V, RF to IF Converting

Test condition : Measured on BeRex E/B at 25°C, 50ohm system, Vdd=3.3V, I_{ds}=62mA , Down converting

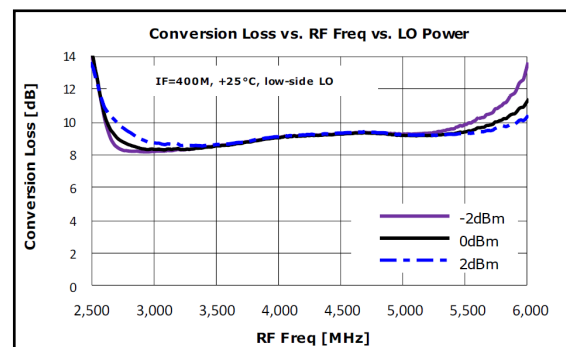
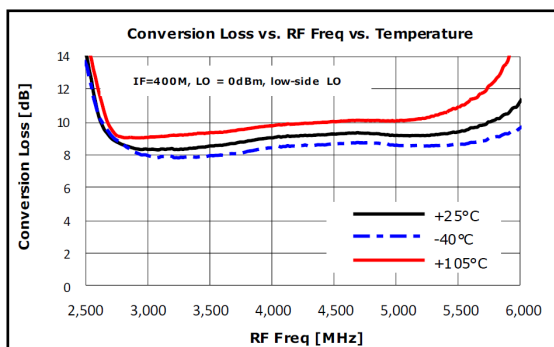
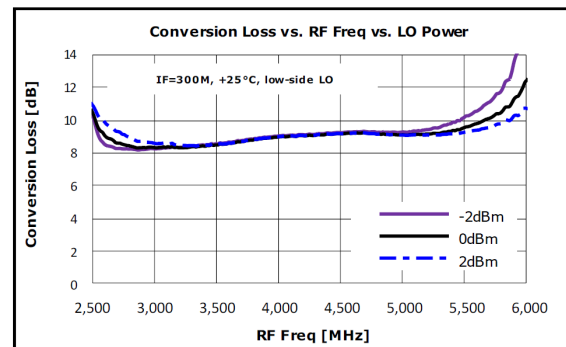
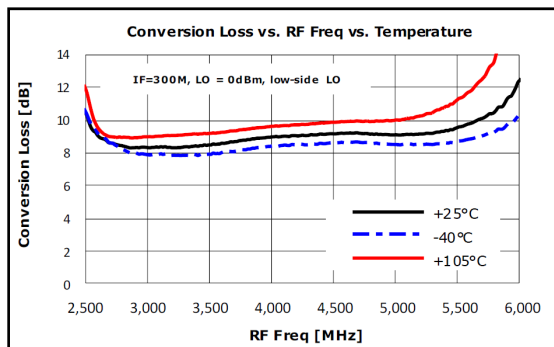
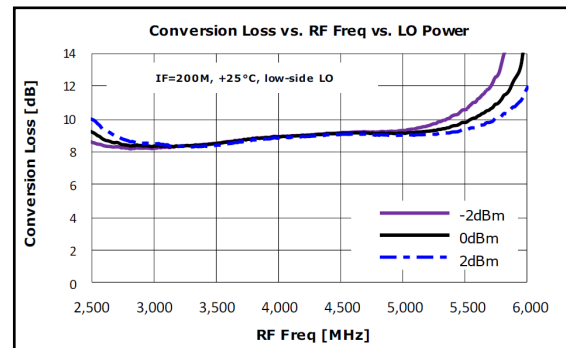
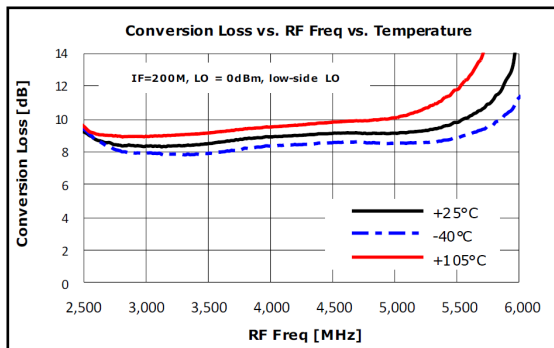
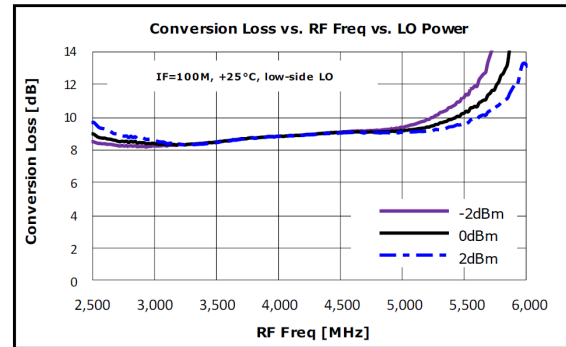
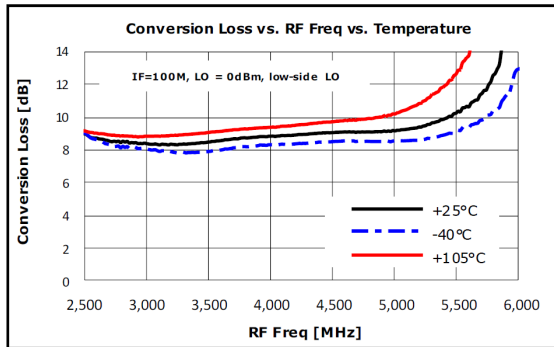

Typical Test Data : 3.3V, RF to IF Converting

Test condition : Measured on BeRex E/B at 25°C, 50ohm system, Vdd=3.3V, I_{ds}=62mA , Down converting

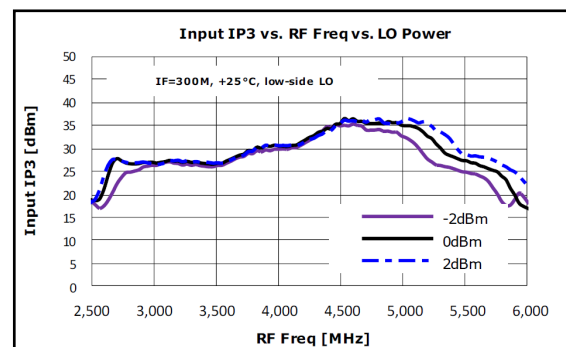
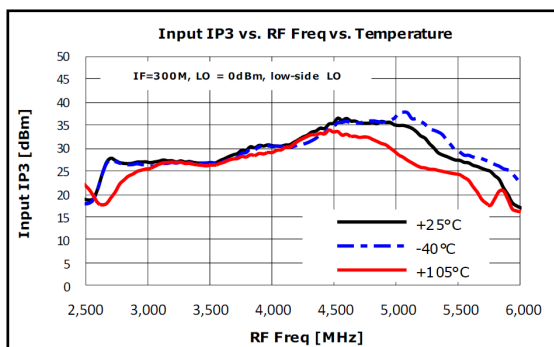
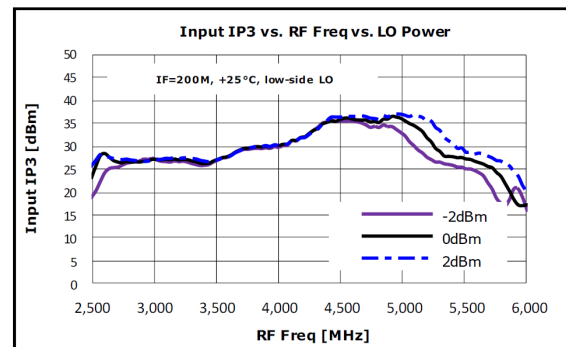
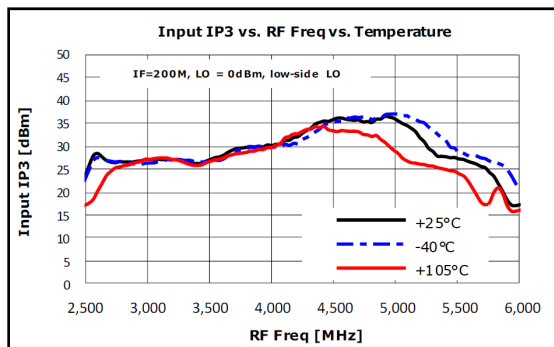
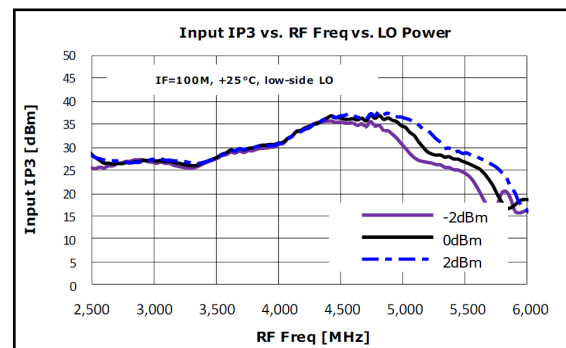
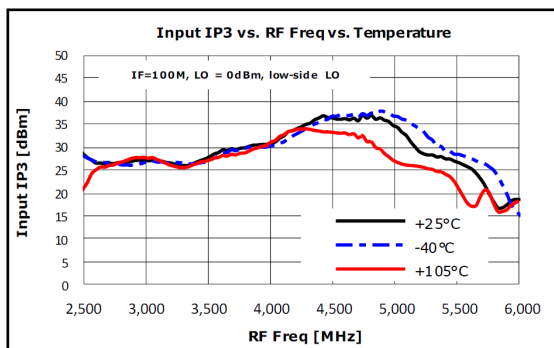
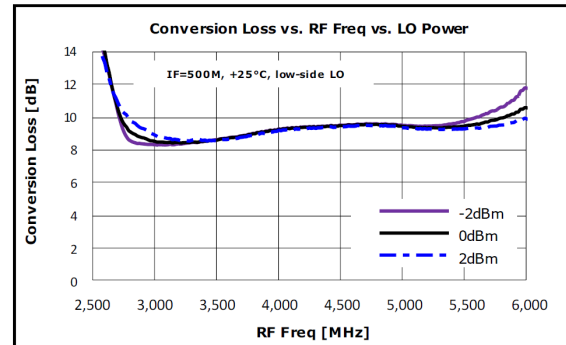
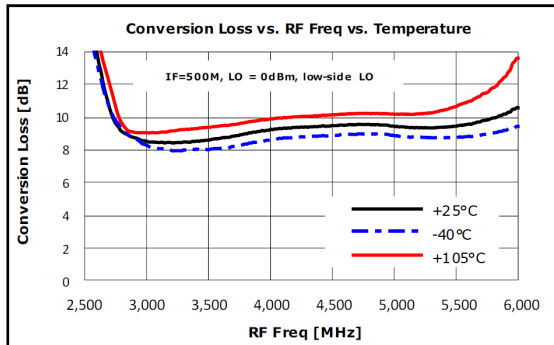

Typical Test Data : 3.3V, RF to IF Converting

Test condition : Measured on BeRex E/B at 25°C, 50ohm system, Vdd=3.3V, I_{ds}=62mA , Down converting

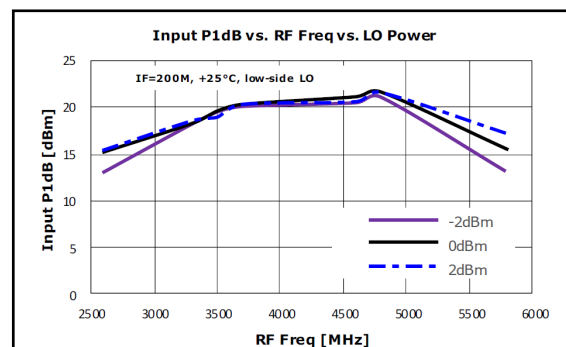
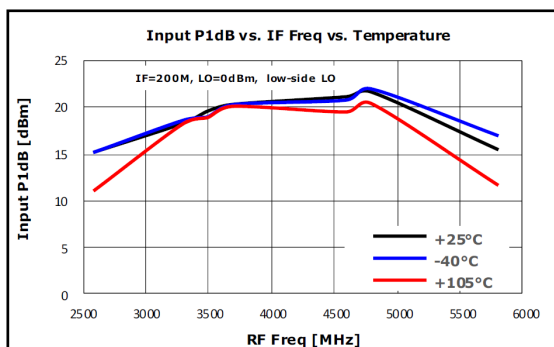
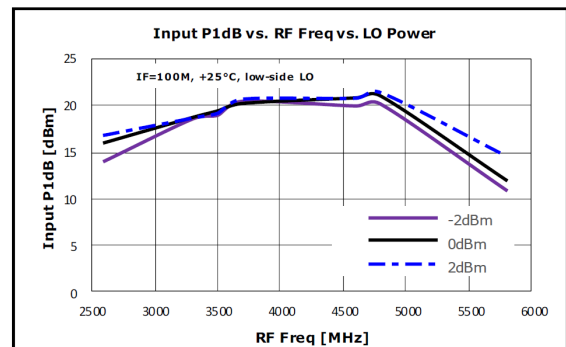
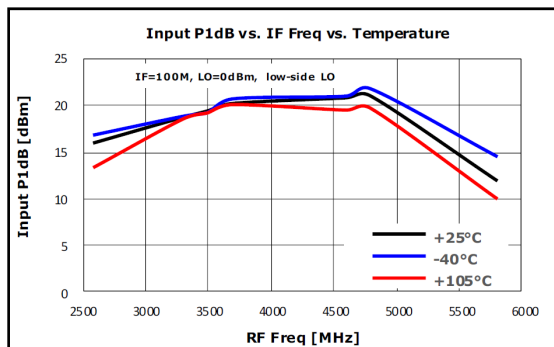
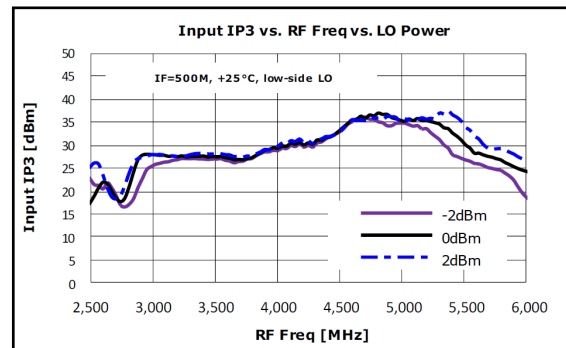
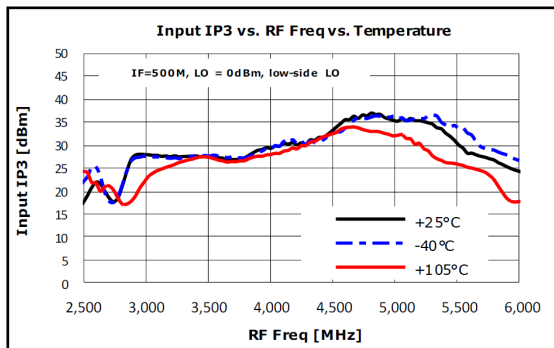
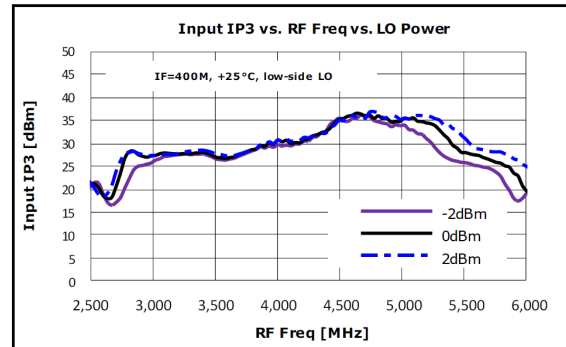
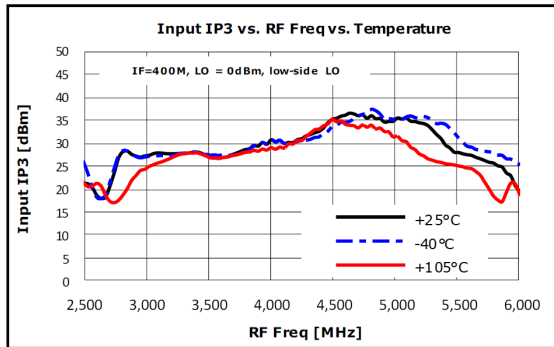

Typical Test Data : 3.3V, RF to IF Converting

Test condition : Measured on BeRex E/B at 25°C, 50ohm system, Vdd=3.3V, I_{ds}=62mA , Down converting

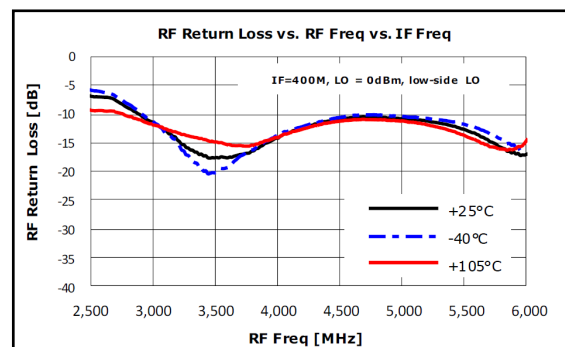
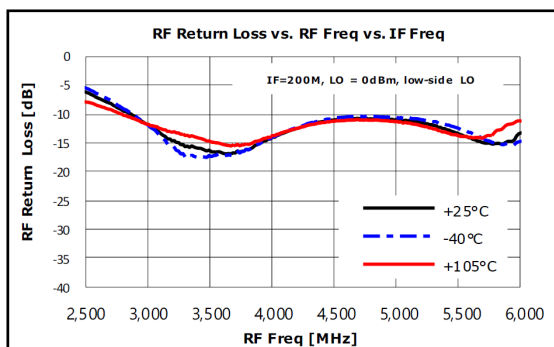
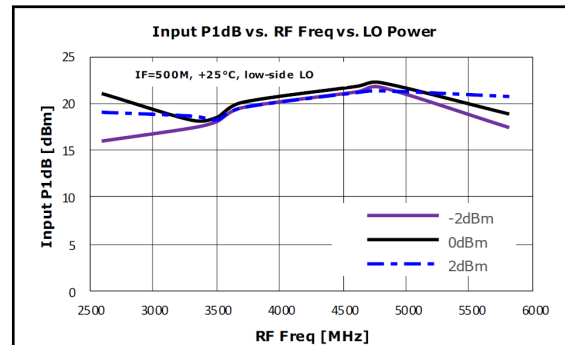
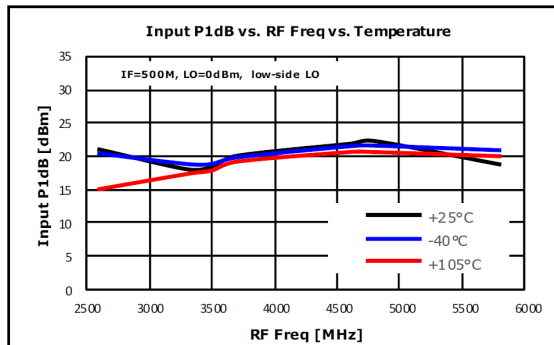
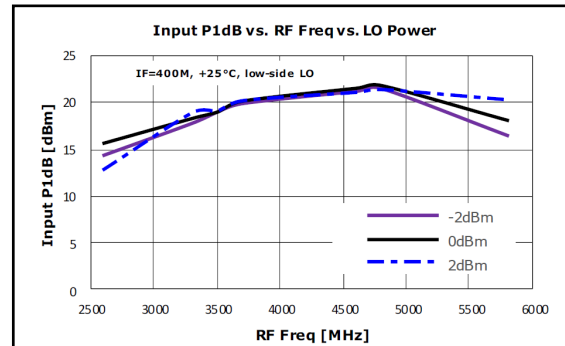
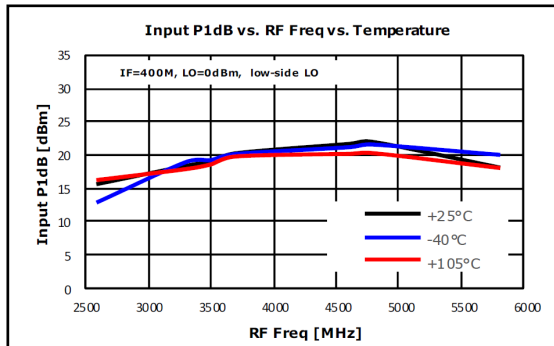
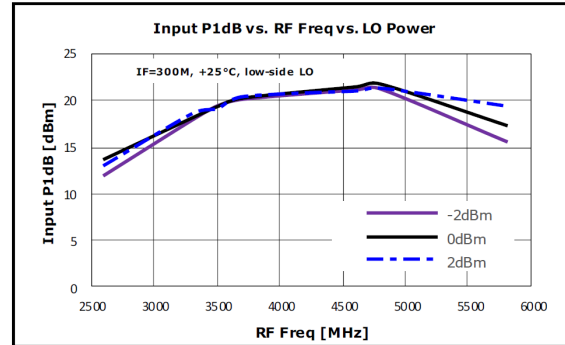
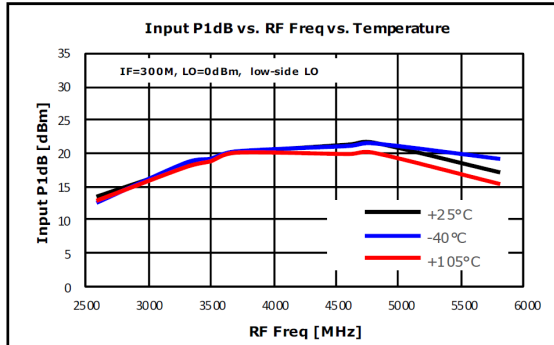

Typical Test Data : 3.3V, IF to RF Converting

Test condition : Measured on BeRex E/B at 25°C, 50ohm system, Vdd=3.3V, I_{ds}=62mA , Up converting

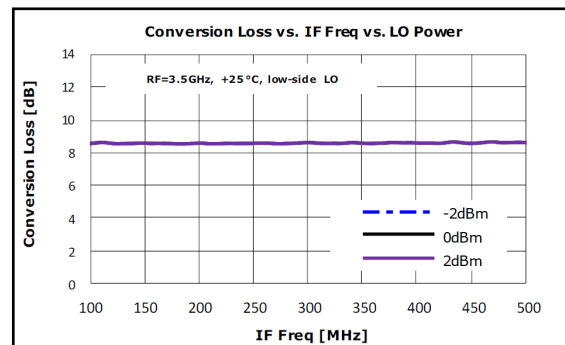
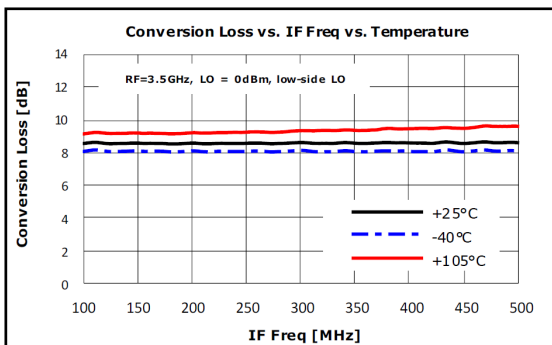
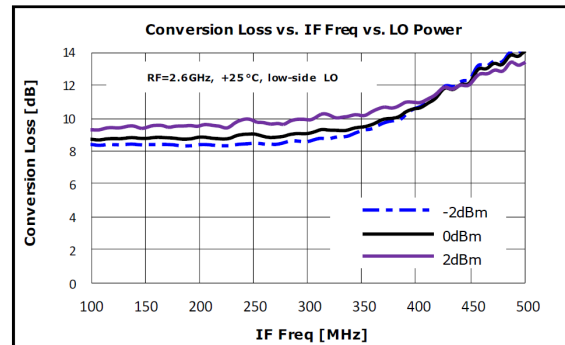
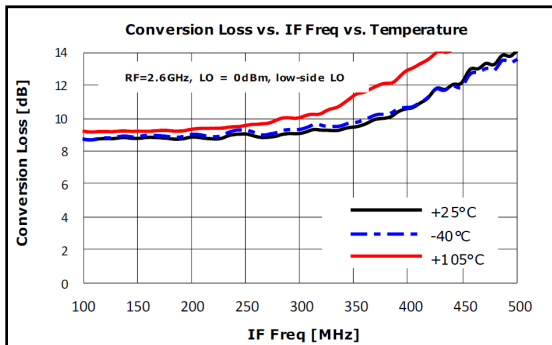
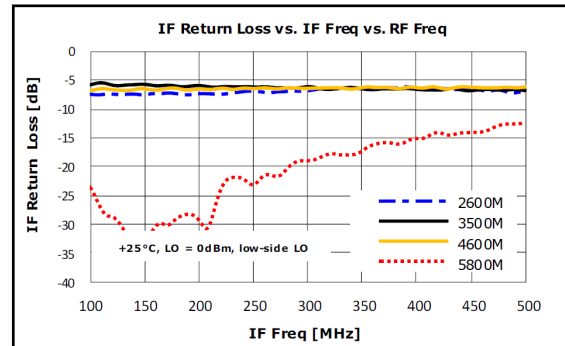
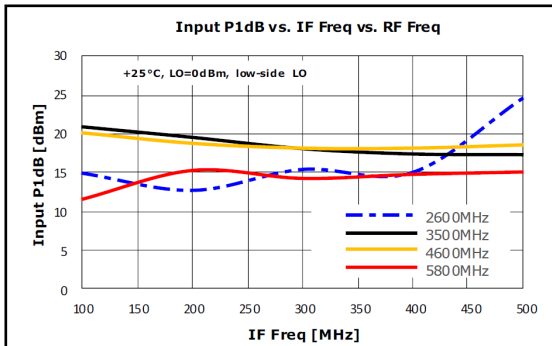
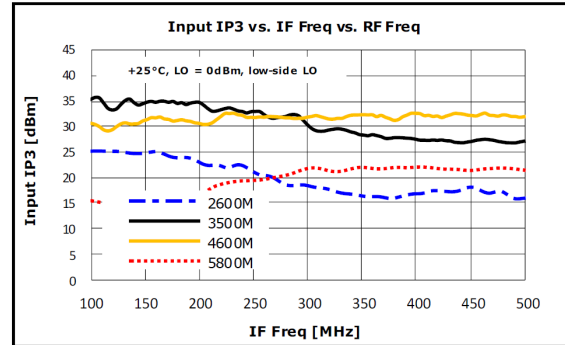
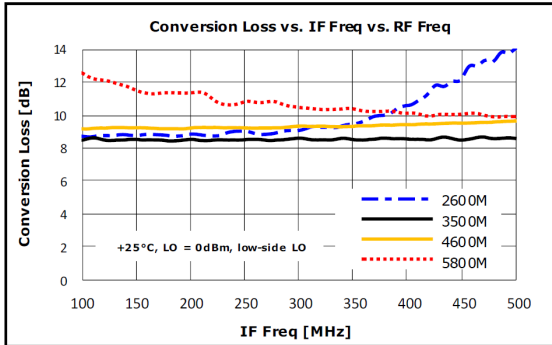

Typical Test Data : 3.3V, IF to RF Converting

Test condition : Measured on BeRex E/B at 25°C, 50ohm system, Vdd=3.3V, I_{ds}=62mA , Up converting

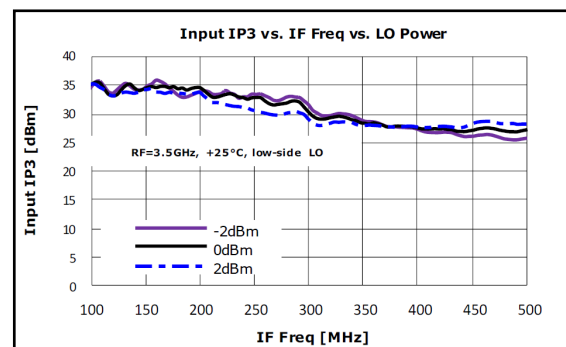
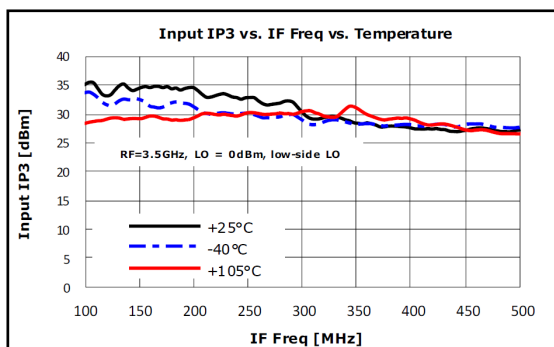
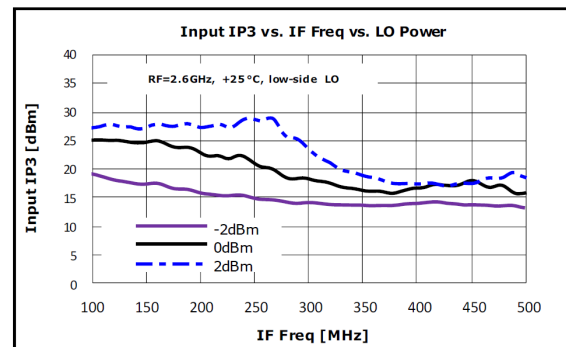
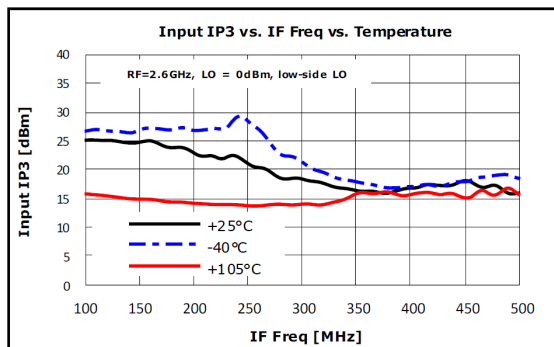
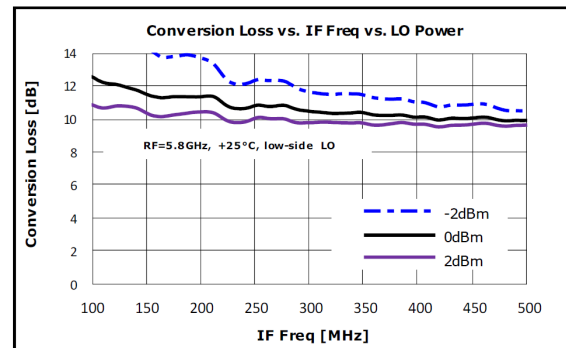
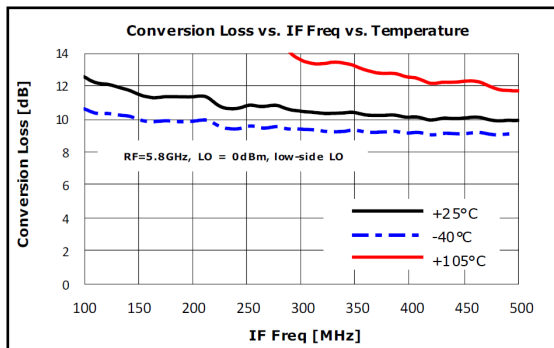
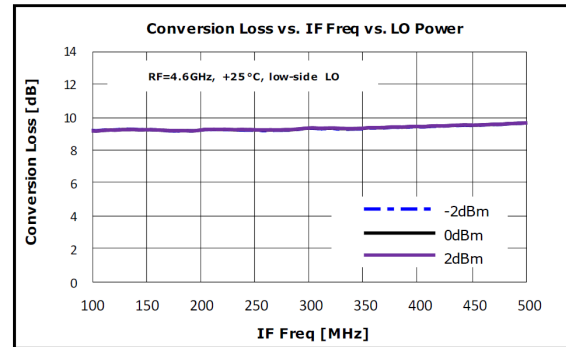
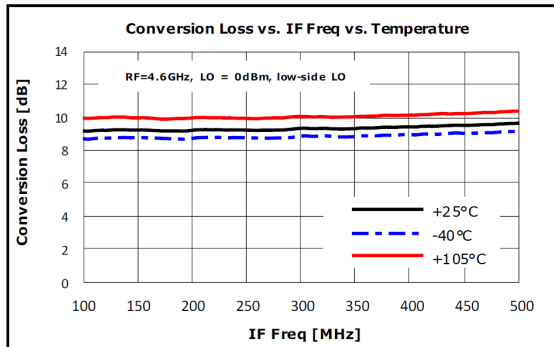

Typical Test Data : 3.3V, IF to RF Converting

Test condition : Measured on BeRex E/B at 25°C, 50ohm system, Vdd=3.3V, I_{ds}=62mA , Up converting

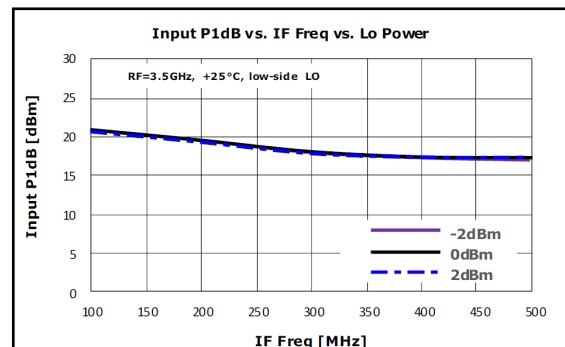
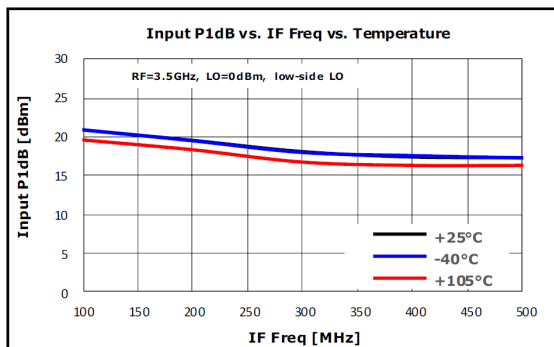
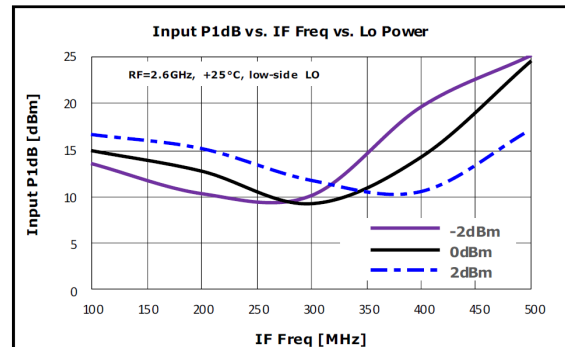
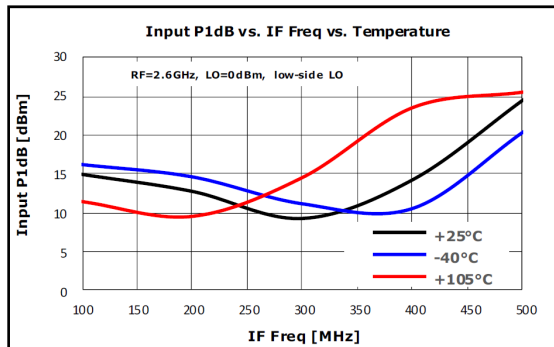
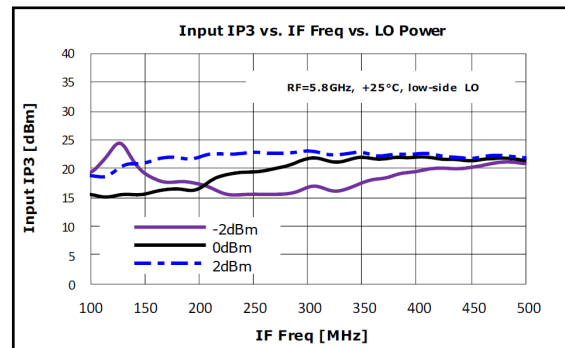
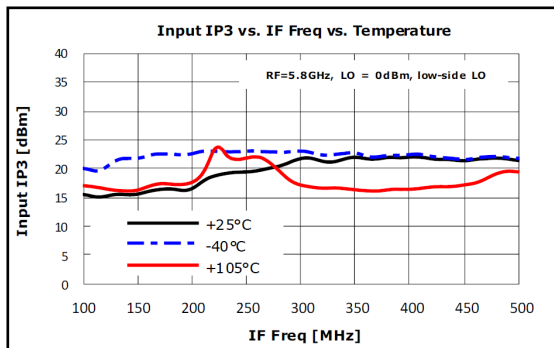
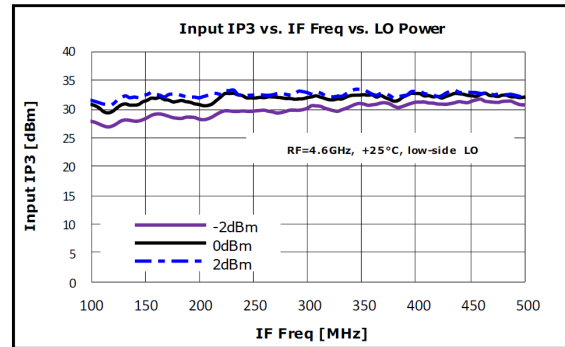
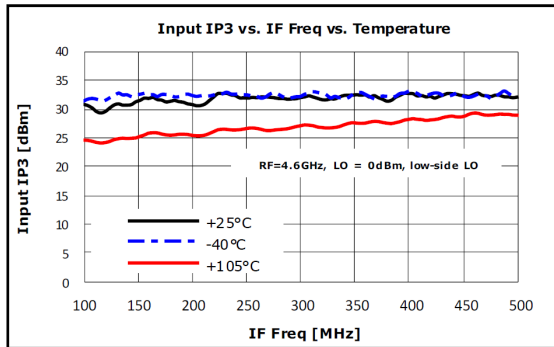

Typical Test Data : 3.3V, IF to RF Converting

Test condition : Measured on BeRex E/B at 25°C, 50ohm system, Vdd=3.3V, I_{ds}=62mA , Up converting

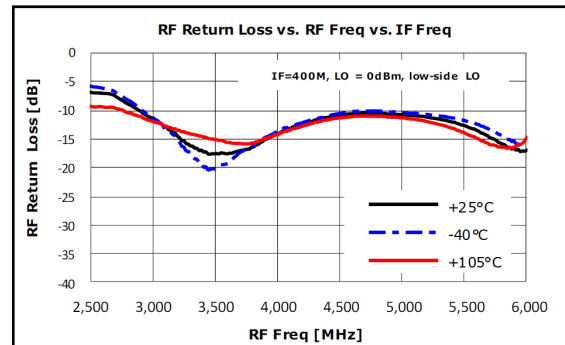
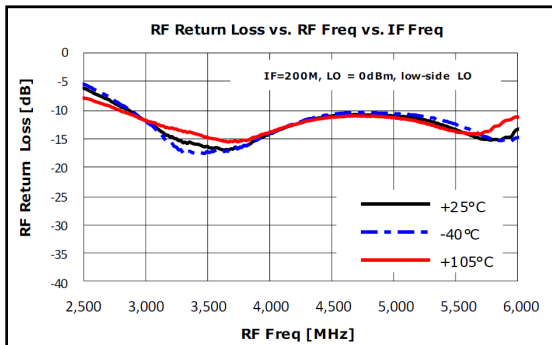
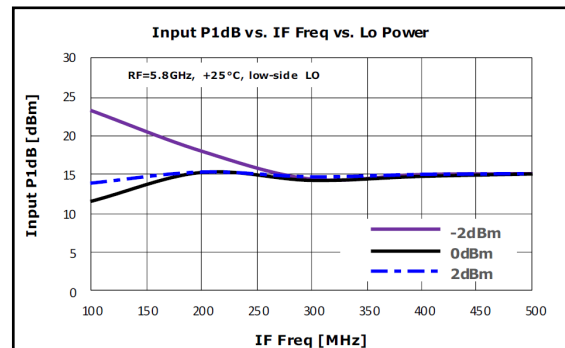
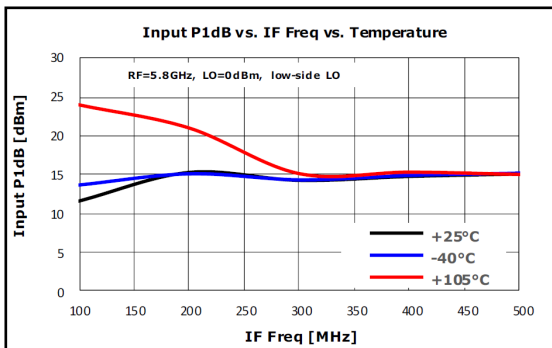
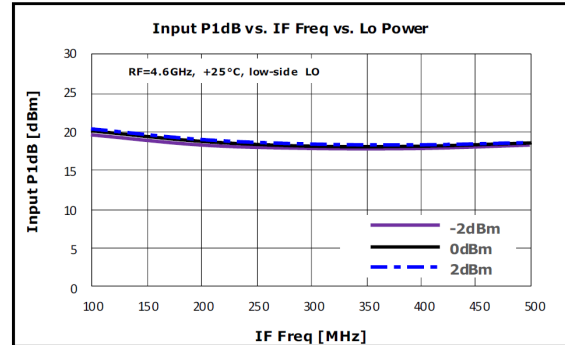
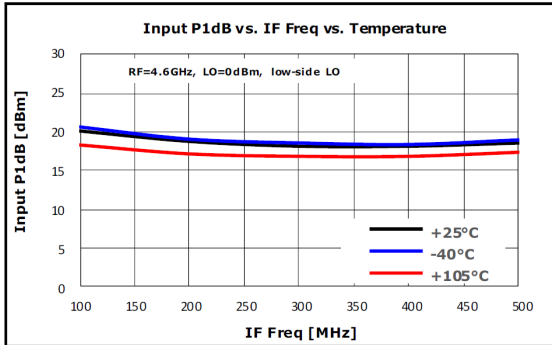

Package Outline Drawing

A ORIGINAL ISSUE OCT13,2014

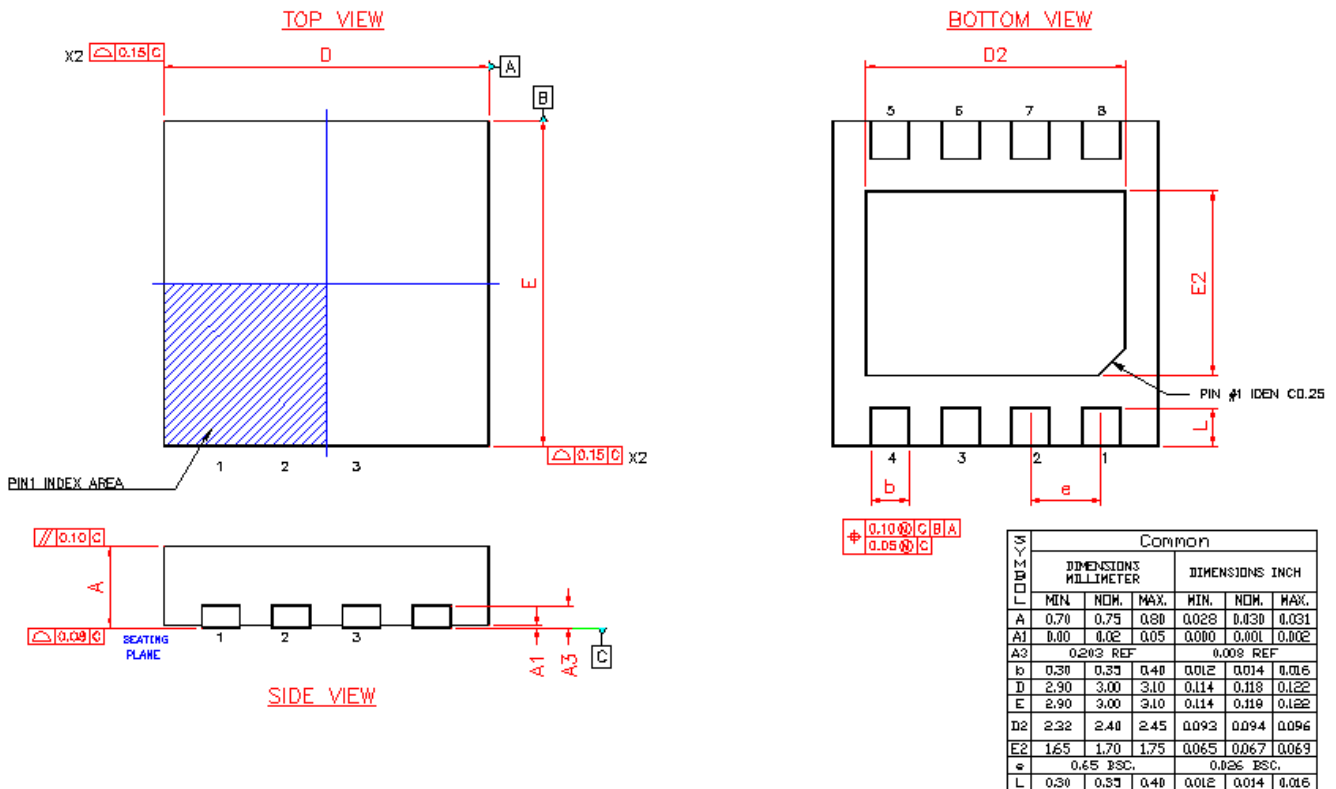

Package Marking



YY = Year, WW = Working Week,
XX = Wafer No.

Evaluation Board Drawing

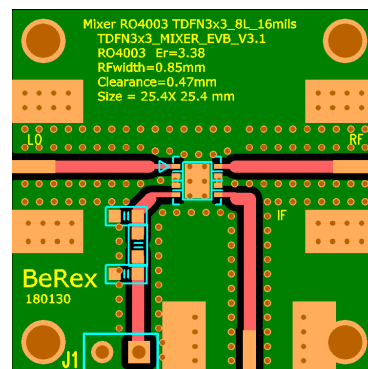

Suggested PCB Land Pattern and PAD Layout

PCB Land Pattern

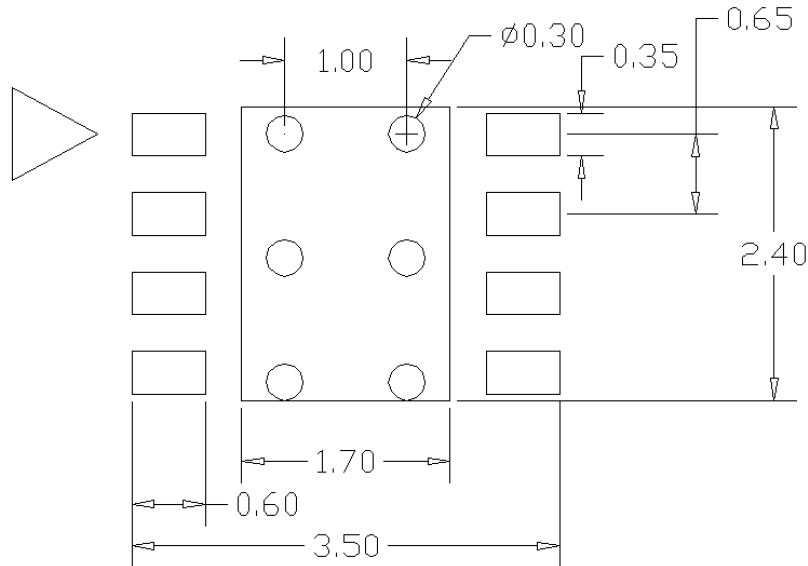

Note : 1. Connection to Bottom Ground with multiple via holes.

2. Via holes _ as many as possible.
3. All Dimensions _ millimeters.
4. PCB lay out _ on BeRex website.

Pin Configuration

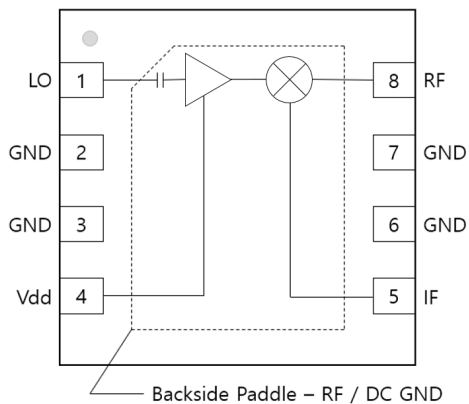

Pin No.	Label	Description
1	LO	Local Oscillator Injection. Internally DC Blocked
2,3,6,7	GND	RF/DC Ground.
4	Vdd	Power supply for LO amplifier
5	IF	Intermediate Frequency
8	RF	Radio Frequency
Backside Paddle	GND	RF/DC Ground. Follow recommended via pattern and ensure good solder attach for best thermal and electrical performance.

Tape & Reel

TDFN-8L 3x3

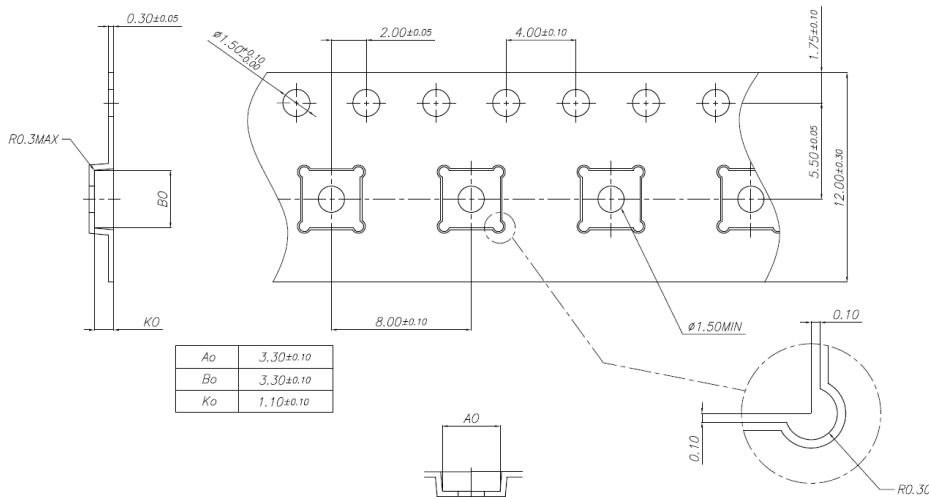

Packaging information :

Tape width(mm) : 12

Reel Size (inches) : 7

Device Cavity Pitch(mm) : 8

Devices Per Reel : 1000

Lead plating finish

100% Tin Matte finish

(All BeRex products undergoes a 1 hour, 150 degree C, Anneal bake to eliminate thin whisker growth concerns.)

MSL / ESD Rating

ESD Rating:	Class 1A
Value:	Passes <500V
Test:	Human Body Model (HBM)
Standard:	JEDEC Standard JS-001-2014
MSL Rating:	Level 1 at +260°C convection reflow
Standard:	JEDEC Standard J-STD-020



Proper ESD procedures should be followed when handling this device.

RoHS Compliance

This part is compliant with Restrictions on the Use of Certain Hazardous Substances in Electrical and Electronic Equipment (RoHS) Directive 2011/65/EU as amended by Directive 2015/863/EU.

This product also is compliant with a concentration of the Substances of Very High Concern (SVHC) candidate list which are contained in a quantity of less than 0.1%(w/w) in each components of a product and/or its packaging placed on the European Community market by the BeRex and Suppliers.

NATO CAGE code:

2	N	9	6	F
----------	----------	----------	----------	----------