

500 – 1500 MHz High Linearity LNA

Device Features

- Internally matched to 50 ohms
- Operated at 3.0V and 5.0V
- 37.5 dBm Output IP3 at 0dBm/tone at 700MHz
- 22.5dB Gain at 700MHz
- 21.1dBm P1dB at 700 MHz
- 0.40 dB NF at 700MHz on evaluation board
- Green/RoHS2 Compliant DFN8 2x2 Package

Product Description

BeRex's BLB01 is a high linearity LNA, based on GaAs material with E-pHEMT process and packaged in a RoHS2-compliant DFN 8L 2x2mm² Surface mount package. It is designed for use where low noise and high linearity are required and features low noise and high OIP3 at Frequency range of 0.5~1.5GHz. It is internally matched to 50 Ohms without external matching components, with fast enable switching speed for TD-LTE application. All devices are 100% RF/DC tested and classified as HBM ESD Class 1C.

Applications

- Base station Infrastructure/RFID
- Commercial/Industrial/Military wireless system
- TDD or FDD LTE systems

Applications Circuit

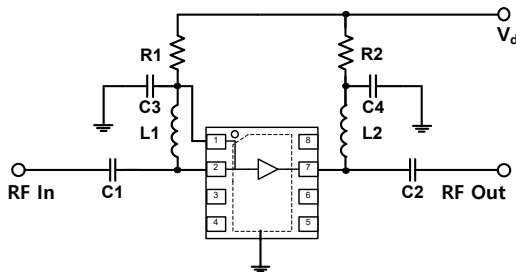

* Refer to [page 14](#) for Enable application.

BOM	Value	Size	Vendor
C1,C4	100pF	0603	Samsung
C2,C3	12pF	0603	Samsung
R1	6.8Kohm	0603	Samsung
R2	0 ohm	0603	Samsung
L1	27nH	0603	Taiyo Yuden
L2	82nH	0603	Taiyo Yuden

Part Marking (XX:Wafer number)

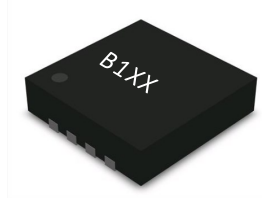

Electrical Specifications

Device performance _ measured on a BeRex evaluation board at 25°C, Vd=5V, 50 Ω system.

Parameter	Conditions	Min	Typ	Max	Unit
Operational Frequency Range		500		1500	MHz
Test Frequency			700		MHz
Gain		21.0	22.5		dB
Input Return Loss			-12.3		dB
Output Return Loss			-15.4		dB
Output IP3	0 dBm / tone , Δf=1 MHz	34.5	37.5		dBm
Output P1dB		20.1	21.1		dBm
Noise Figure			0.4	0.6	dB

* NF : Losses on input and output transmission lines on PCB are not de-embedded.

Device performance _ measured on a BeRex evaluation board at 25°C, Vd=3V, 50 Ω system.

Parameter	Conditions	Min	Typ	Max	Unit
Operational Frequency Range		500		1500	MHz
Test Frequency			700		MHz
Gain		21.0	21.4		dB
Input Return Loss			-12.1		dB
Output Return Loss			-12.9		dB
Output IP3	0 dBm / tone , Δf=1 MHz	34.5	30.5		dBm
Output P1dB		20.1	16.9		dBm
Noise Figure			0.39	0.6	dB

* NF : Losses on input and output transmission lines on PCB are not de-embedded.

Recommended Operating Conditions

Parameter	Min	Typ	Max	Unit
Bandwidth	500		1500	MHz
I _d @ (V _d = 5.0V)	53	66	79	mA
I _d @ (V _d = 3.0V)	22	27	32	mA
V _d	3	5	5.25	V
dG/dT		-0.008		dB/°C
R _{TH}		24.76		°C/W
Operating Case Temperature	-40		+105	°C
Switching Time(T _{on})		140		ns
Switching Time(T _{off})		140		ns

Electrical specifications are measured at specified test conditions.

Specifications are not guaranteed over all recommended operating conditions.

500 – 1500 MHz High Linearity LNA

Absolute Maximum Ratings

Parameter	Rating	Unit
Storage Temperature	-55 to +155	°C
Junction Temperature	+160	°C
Supply Voltage	+6	V
Supply Current	130	mA
Input RF Power	21	dBm

Operation of this device above any of these parameters may result in permanent damage.

Typical Performance (V_d=5.0V, I_d=66mA, T=25°C)

Parameter	Frequency					Unit
	500	700	800	900	1500	MHz
V _d = 5V						
Gain	24.5	22.5	21.7	21	17.5	dB
S11	-15.5	-12.3	-12.0	-11.7	-11.5	dB
S22	-8.7	-15.4	-19.3	-22.5	-15.8	dB
OIP3	38.0	37.5	35.5	35.5	32.5	dBm
P1dB	21.2	21.1	21.2	20.9	19.3	dBm
Noise Figure	0.65	0.40	0.38	0.40	0.62	dB

* NF : Losses on input and output transmission lines on PCB are not de-embedded.

Typical Performance (V_d=3.0V, I_d=27mA, T=25°C)

Parameter	Frequency					Unit
	500	700	800	900	1500	MHz
V _d = 3V						
Gain	23.3	21.4	20.5	19.7	16.1	dB
S11	-18.3	-12.1	-11.0	-10.4	-9.3	dB
S22	-7.4	-12.9	-15.0	-16.5	-13.7	dB
OIP3	31.0	30.5	29.5	28.5	27.0	dBm
P1dB	16.2	16.9	17.1	17.2	17.5	dBm
Noise Figure	0.62	0.39	0.37	0.38	0.60	dB

* NF : Losses on input and output transmission lines on PCB are not de-embedded.

500 – 1500 MHz High Linearity LNA

V-I Characteristics

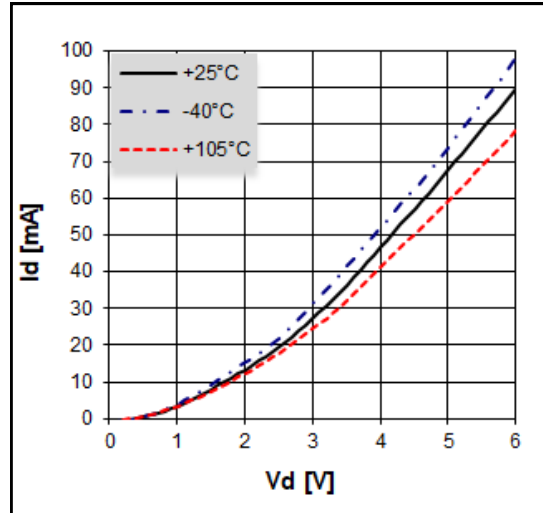

Pin Configuration

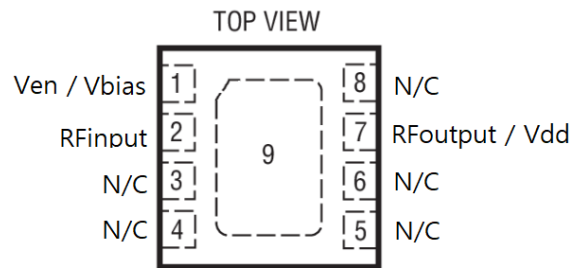

DC PACKAGE
 8-LEAD (2mm × 2mm) PLASTIC DFN
 EXPOSED PAD (PIN 9) IS GND, MUST BE SOLDERED TO PCB

Evaluation Board

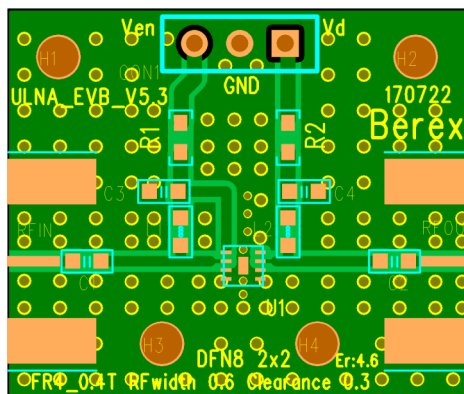

*Dielectric constant _ 4.2 *RF pattern width 24mil *16mil thick FR4 PCB

500 – 1500 MHz High Linearity LNA

Typical Device Data

S-parameters ($V_d=5.0V$, $I_d=66mA$, $T=25^\circ C$)

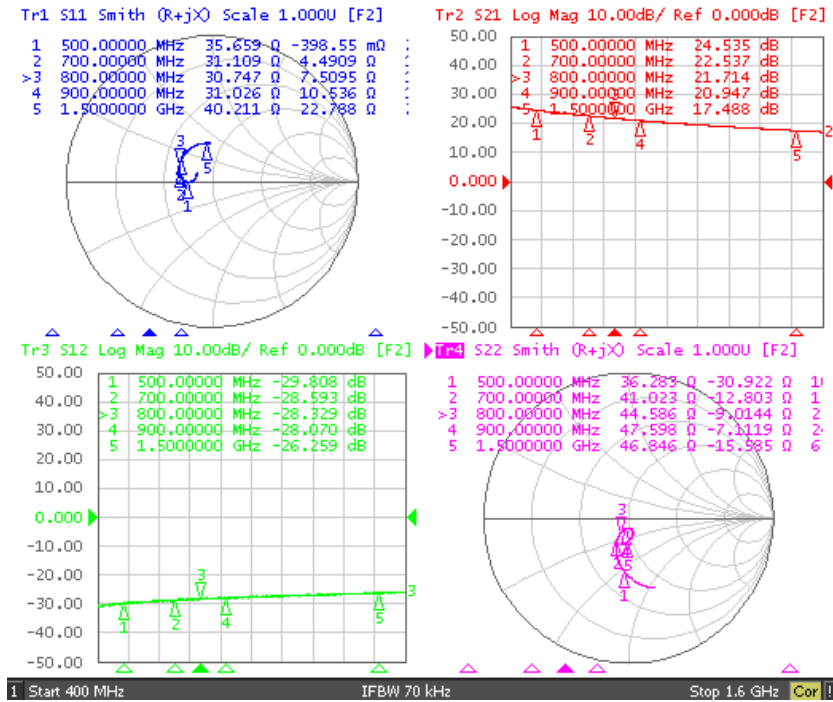

S-parameters ($V_d=3.0V$, $I_d=27mA$, $T=25^\circ C$)

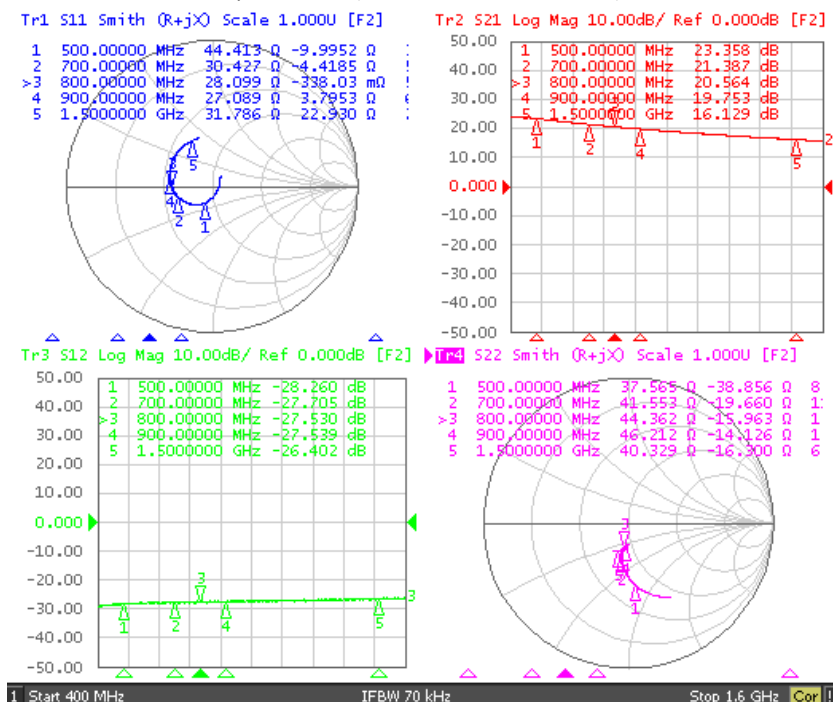

500 – 1500 MHz High Linearity LNA
S-Parameter

(Vd=5.0V, Id = 66mA, T = 25 °C, calibrated to device leads)

Freq [MHz]	S11 Mag	S11 Ang	S21 Mag	S21 Ang	S12 Mag	S12 Ang	S22 Mag	S22 Ang
500	0.23	-124.89	18.00	134.12	0.04	63.62	0.20	-119.48
600	0.29	-140.90	15.43	123.05	0.04	53.44	0.15	-142.56
700	0.30	-151.49	13.67	115.15	0.04	49.45	0.10	-161.73
800	0.31	-157.31	12.36	108.84	0.04	45.30	0.07	-177.33
900	0.30	-163.08	11.33	103.54	0.04	43.09	0.04	164.79
1000	0.29	-166.98	10.52	98.37	0.04	37.82	0.01	113.63
1100	0.28	-170.27	9.82	93.46	0.05	37.16	0.03	4.31
1200	0.27	-172.29	9.17	88.78	0.05	31.40	0.06	-13.23
1300	0.26	-173.09	8.66	84.16	0.05	31.93	0.09	-19.81
1400	0.24	-174.55	8.18	79.84	0.05	28.25	0.12	-25.54
1500	0.23	-174.85	7.78	75.66	0.05	26.86	0.15	-29.69

(Vd=3.0V, Id = 27mA, T = 25 °C, calibrated to device leads)

Freq [MHz]	S11 Mag	S11 Ang	S21 Mag	S21 Ang	S12 Mag	S12 Ang	S22 Mag	S22 Ang
500	0.26	-75.46	15.48	141.37	0.04	55.53	0.26	-88.42
600	0.31	-107.06	13.30	127.53	0.05	45.23	0.17	-102.44
700	0.34	-122.34	11.75	118.21	0.04	38.40	0.11	-104.33
800	0.35	-131.66	10.55	110.48	0.04	35.85	0.08	-95.78
900	0.35	-138.83	9.63	104.26	0.04	31.10	0.07	-76.19
1000	0.35	-143.86	8.88	98.67	0.05	28.25	0.08	-58.96
1100	0.35	-148.58	8.25	93.39	0.05	25.15	0.11	-50.97
1200	0.35	-151.32	7.70	88.38	0.05	24.09	0.13	-47.09
1300	0.35	-153.89	7.23	83.57	0.05	22.66	0.16	-47.34
1400	0.34	-156.28	6.81	78.98	0.05	22.68	0.19	-48.71
1500	0.34	-158.25	6.44	74.59	0.05	19.77	0.21	-49.29

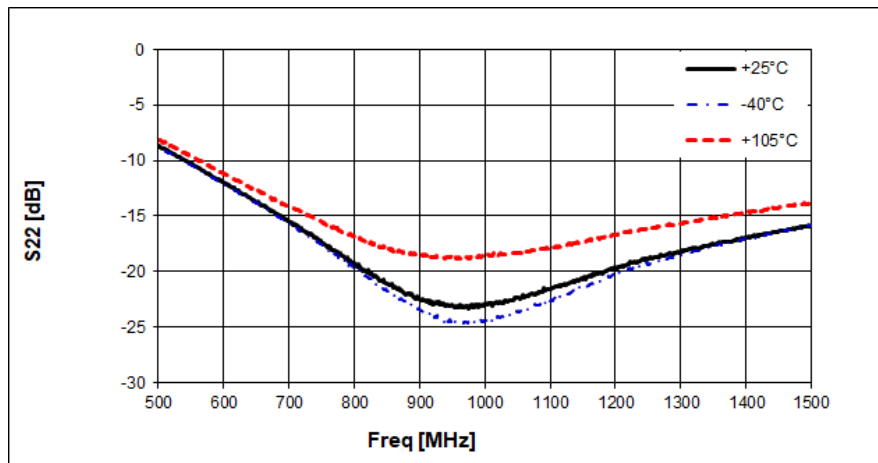
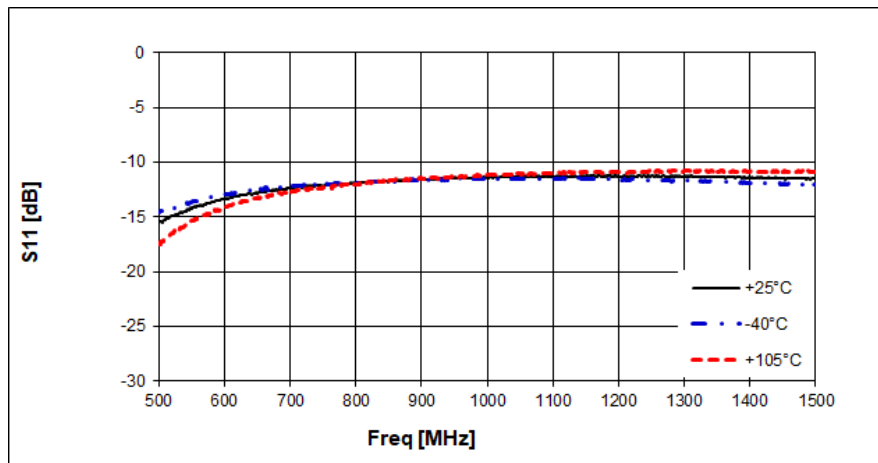
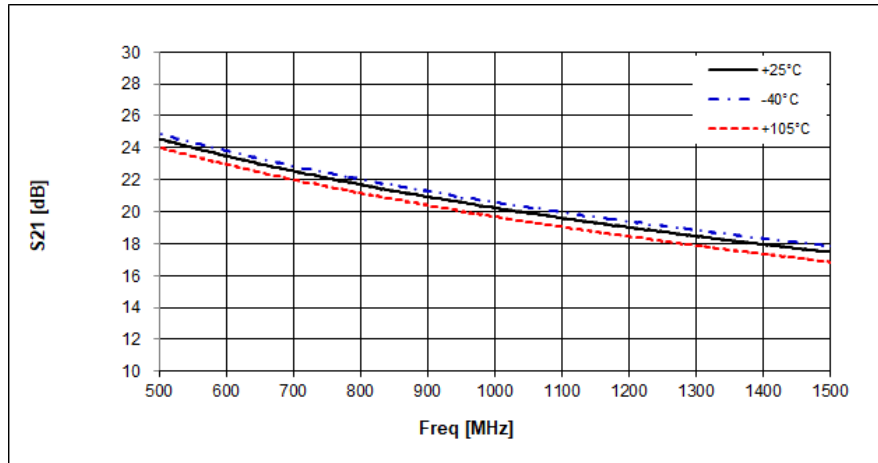
500 – 1500 MHz High Linearity LNA
Typical Performance
(Vd=5.0V, Id=66mA, T=25°C)

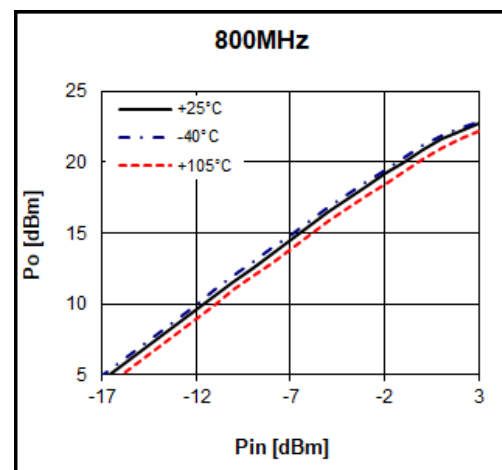
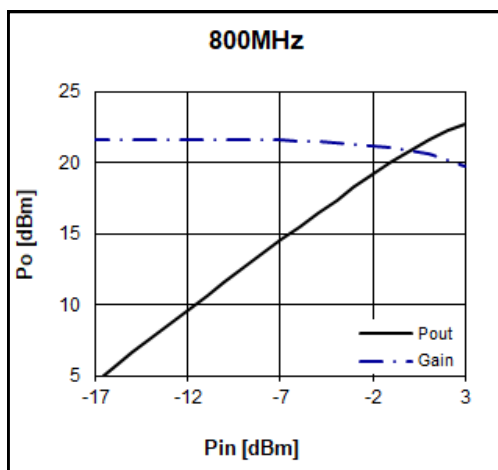
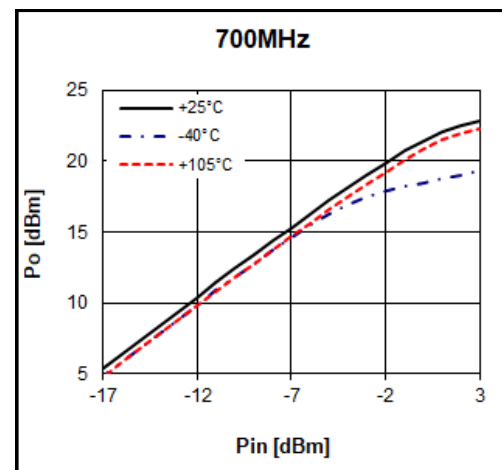
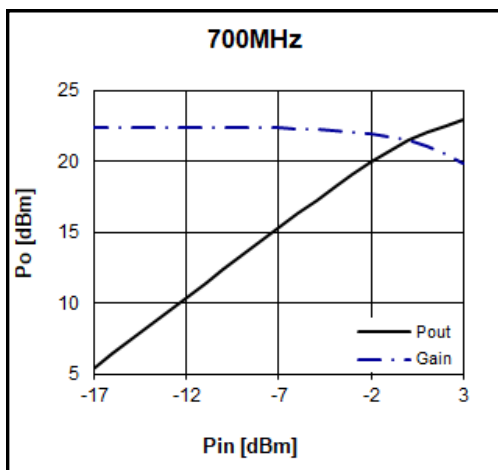
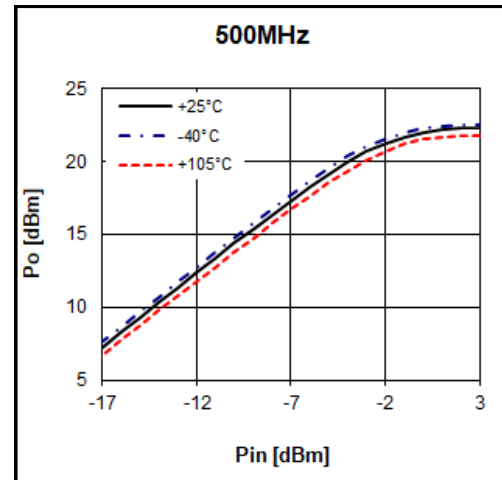
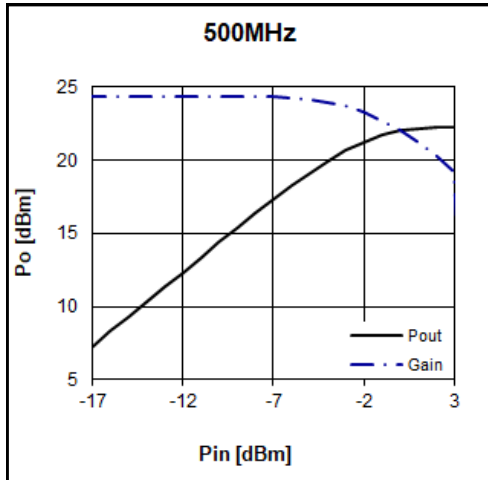
500 – 1500 MHz High Linearity LNA

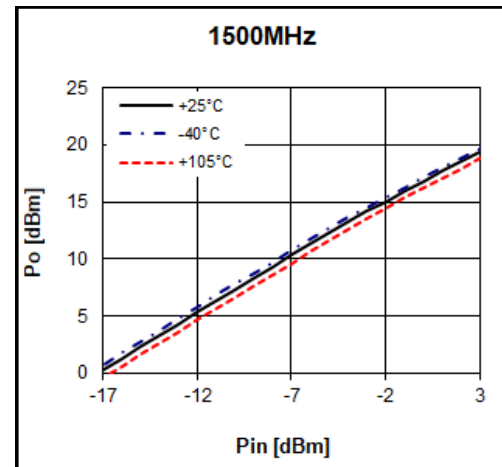
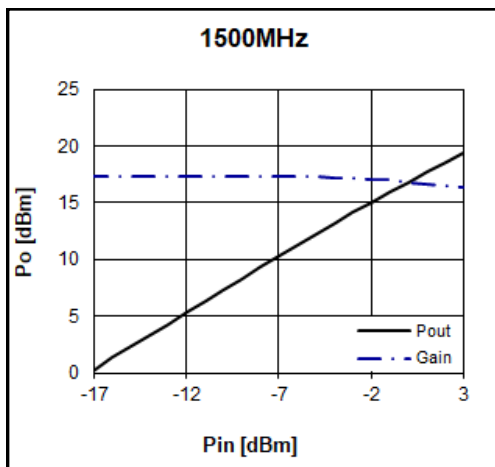
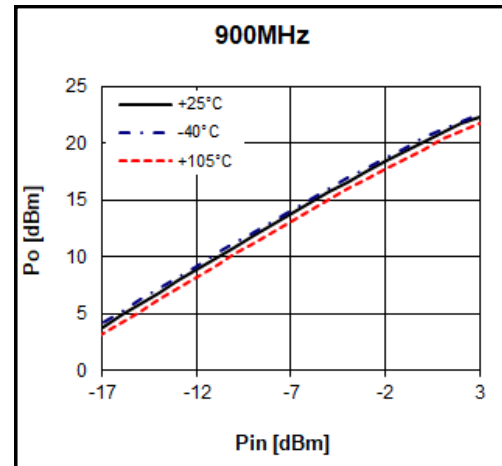
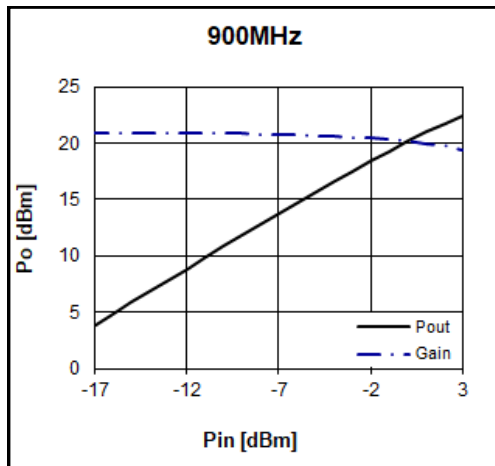
500 – 1500 MHz High Linearity LNA

Noise Figure Temperature Performance

(Vds = 5.0V, Ids = 66mA)

Freq	MHz	500	700	800	900	1500
Temp [°C]	-40	0.60	0.39	0.37	0.38	0.60
	+25	0.65	0.40	0.38	0.40	0.62
	+105	0.75	0.55	0.45	0.45	0.68

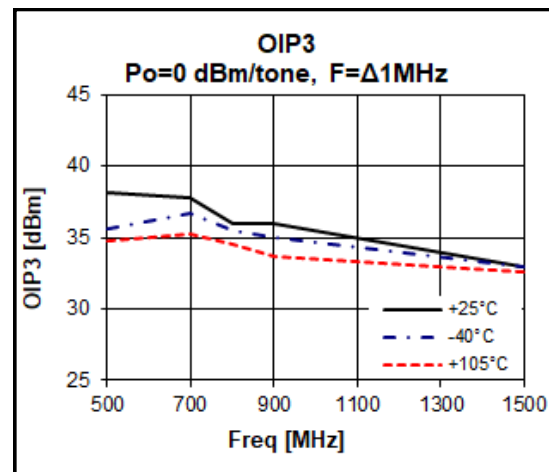
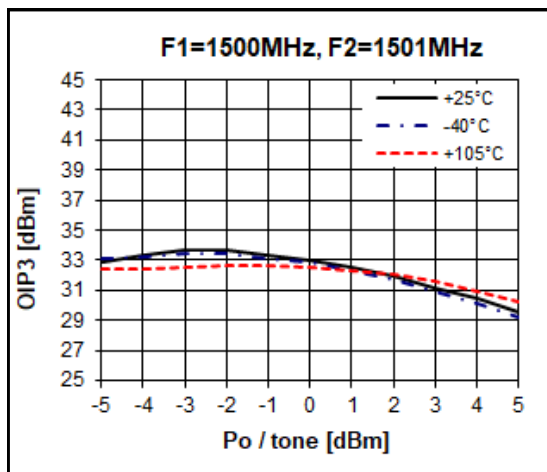
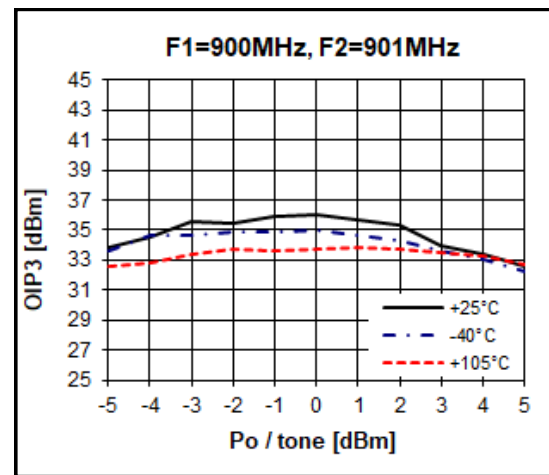
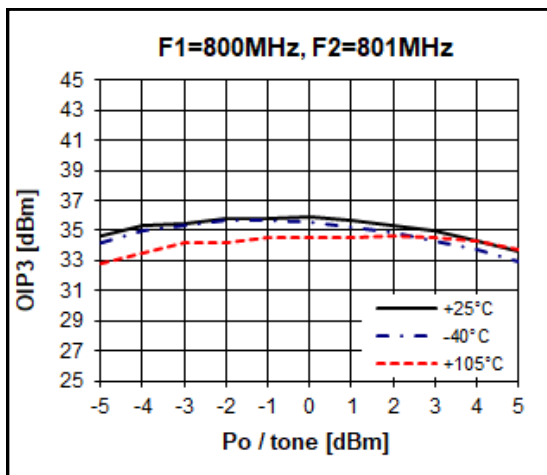
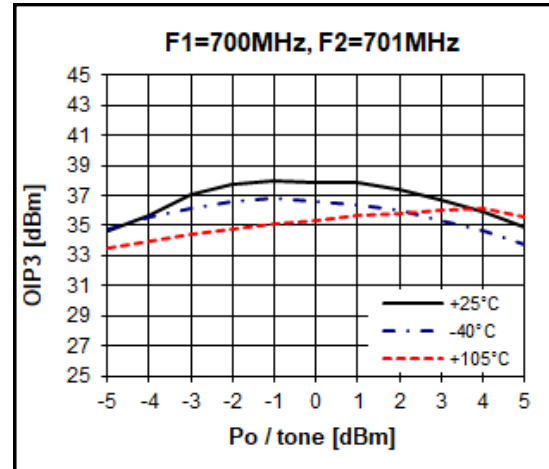
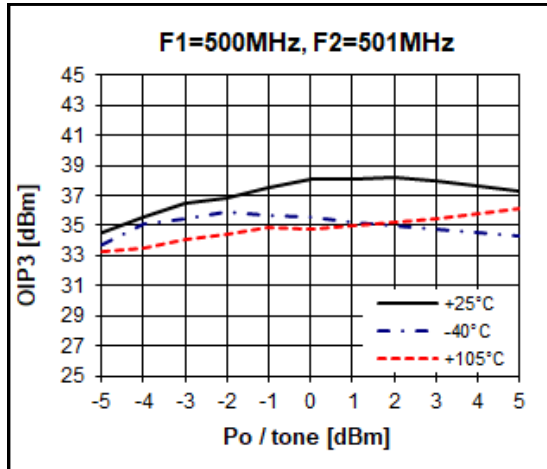
* NF : Losses on input and output transmission lines on PCB are not de-embedded.

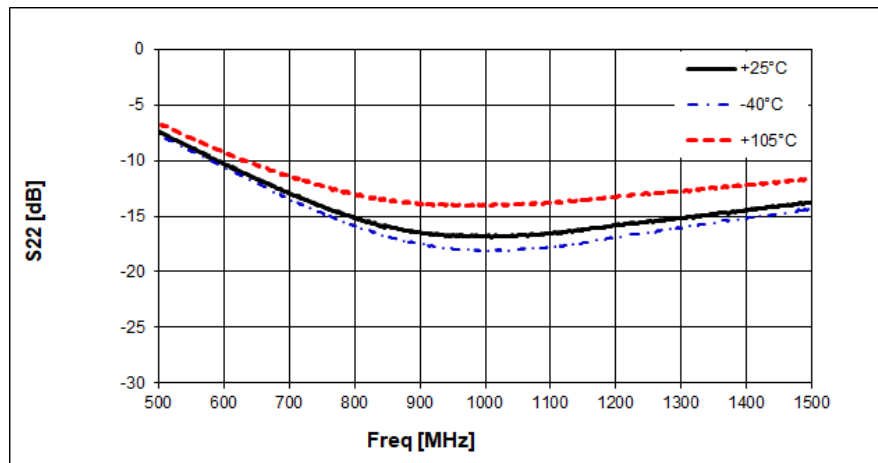
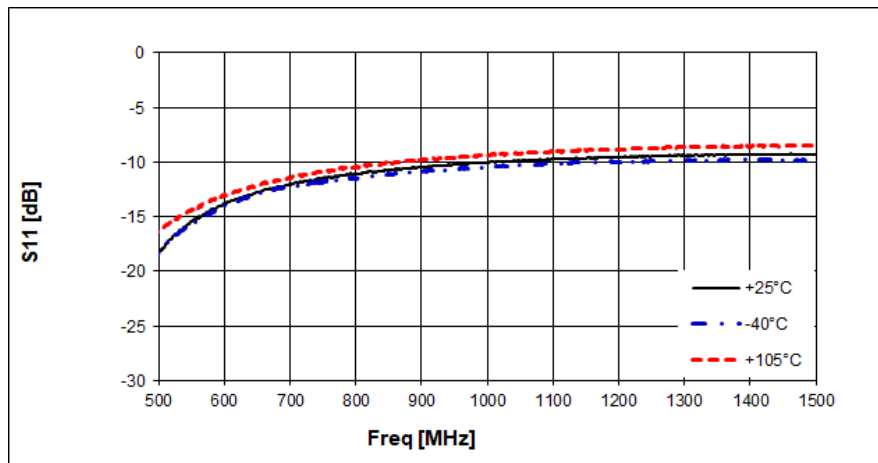
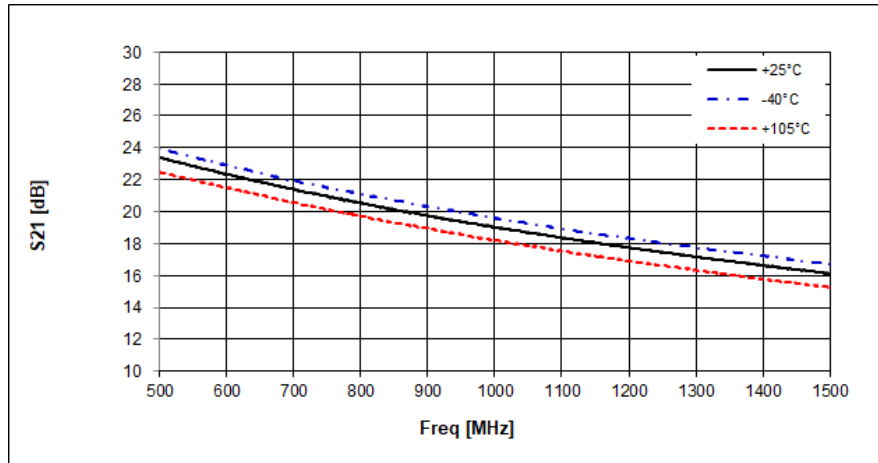
500 – 1500 MHz High Linearity LNA

500 – 1500 MHz High Linearity LNA
Typical Performance
(Vd=3.0V, Id=27mA, T=25°C)

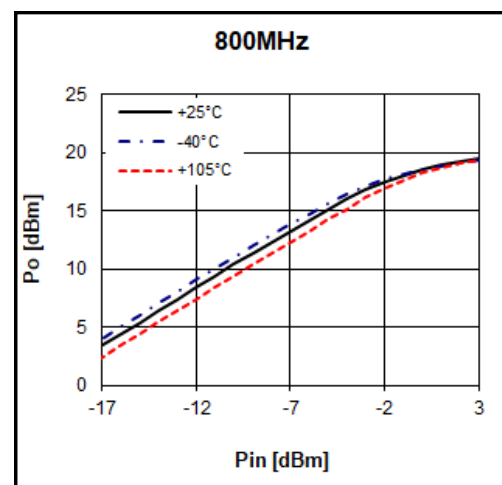
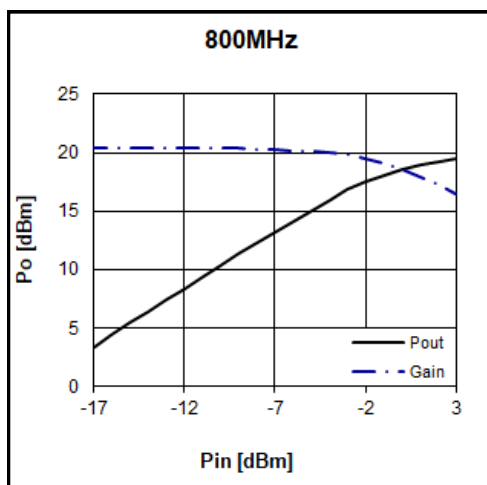
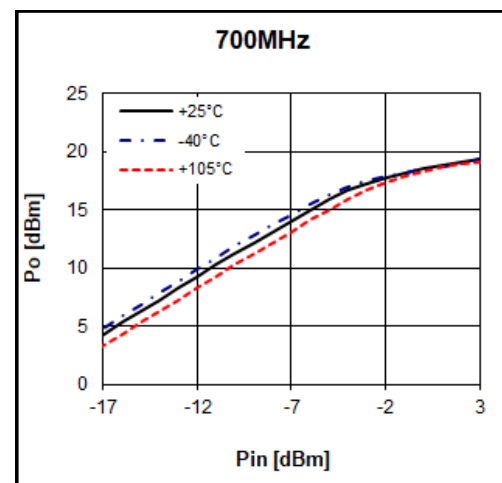
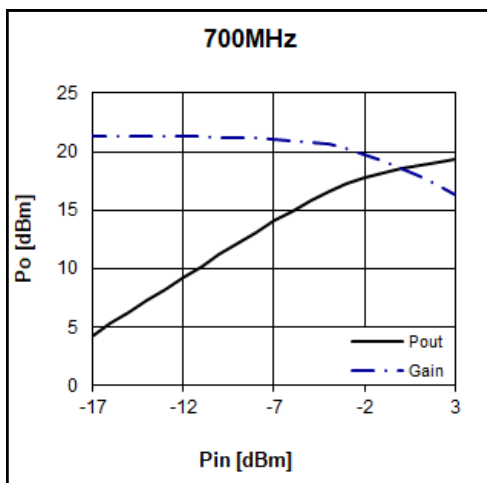
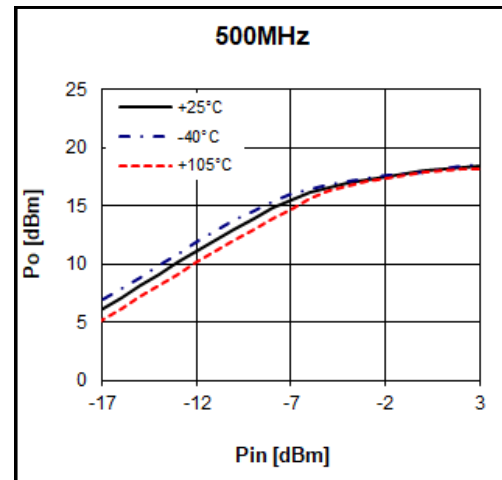
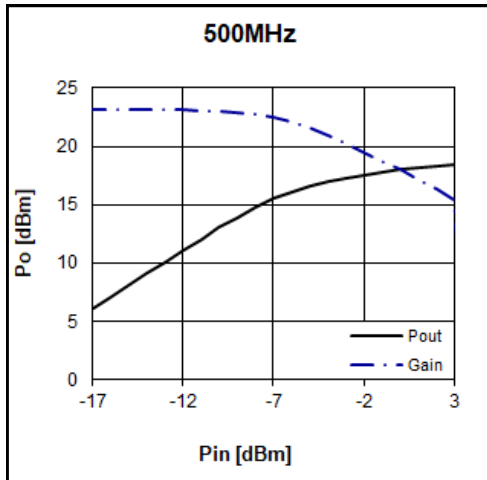
500 – 1500 MHz High Linearity LNA

500 – 1500 MHz High Linearity LNA

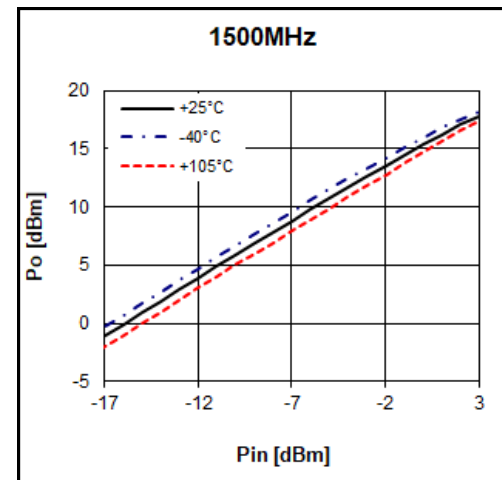
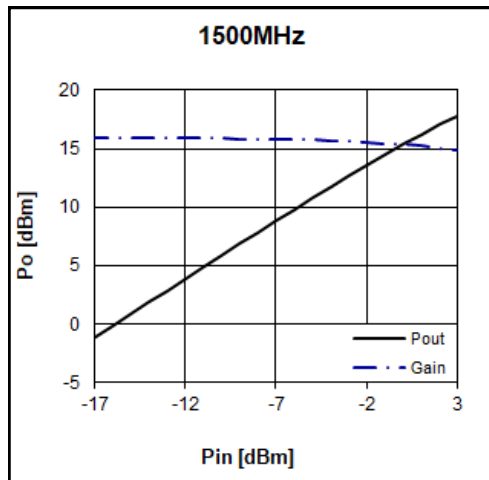
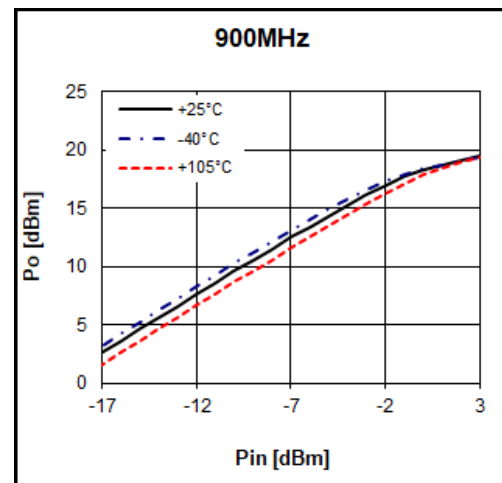
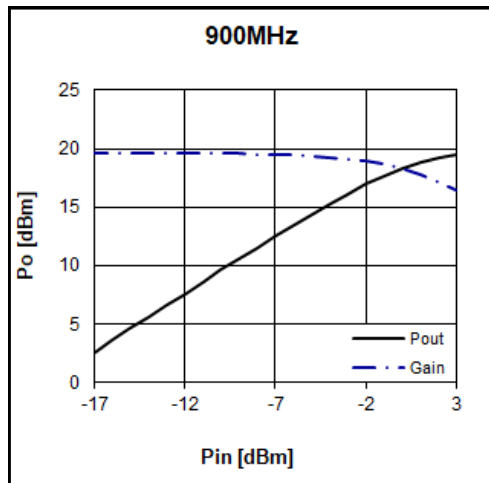

Noise Figure Temperature Performance

(Vds = 3.0V, Ids = 27mA)

Freq	MHz	500	700	800	900	1500
Temp [°C]	-40	0.55	0.37	0.35	0.34	0.58
	+25	0.62	0.39	0.37	0.38	0.60
	+105	0.73	0.53	0.43	0.44	0.70

* NF : Losses on input and output transmission lines on PCB are not de-embedded.

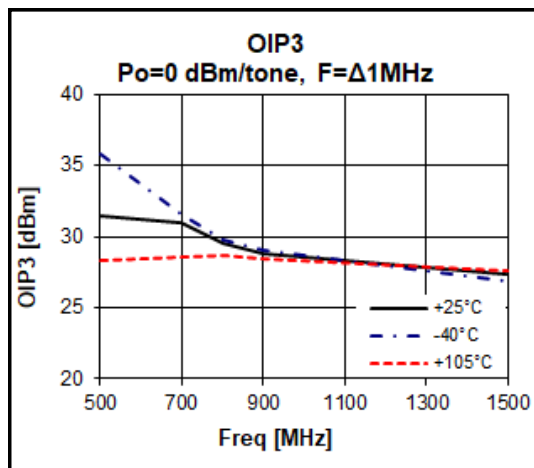
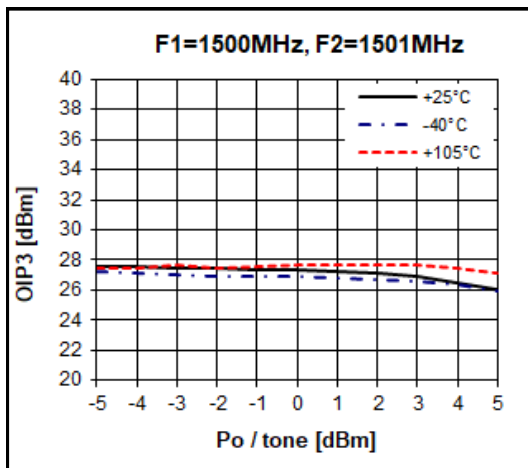
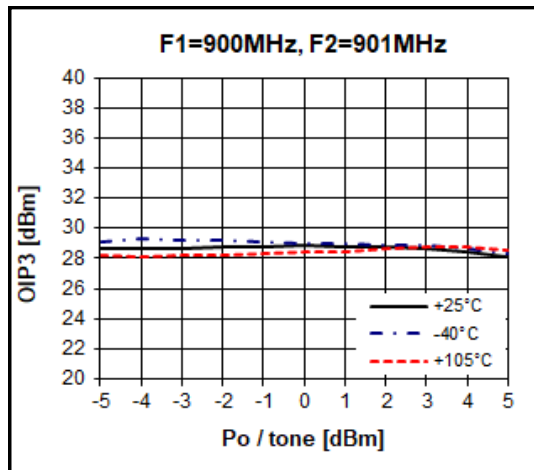
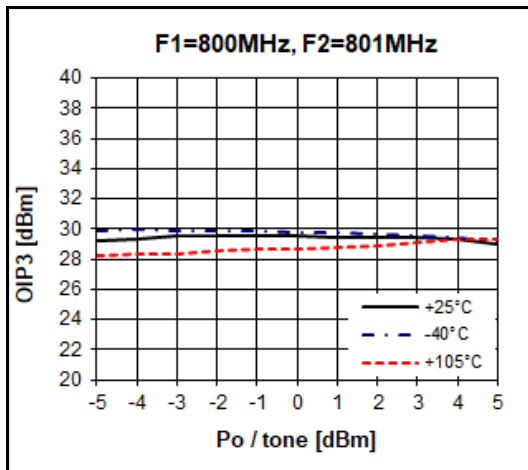
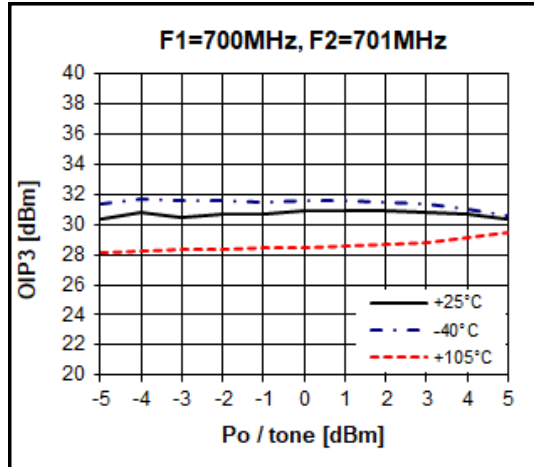
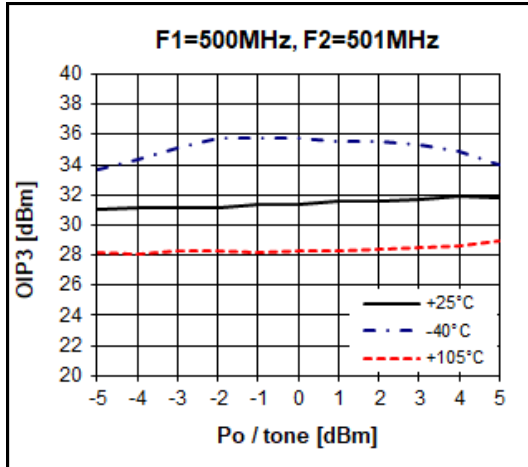
500 – 1500 MHz High Linearity LNA

Enable Application

State function

V_d	V_{en}	State
5V	0V	Off
5V	5V	On

Switching Time

	Min.	Typical	Max.	Unit
Raising time (T_{on})		140		ns
Falling time (T_{off})		140		ns

Application circuit

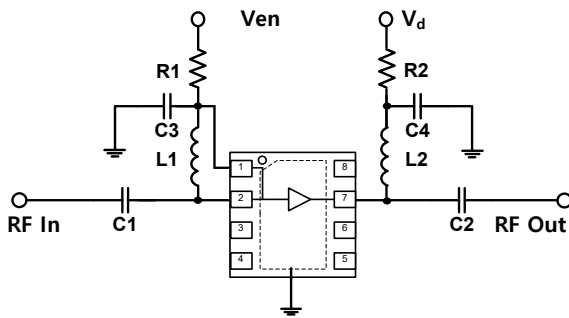

BOM

Component	Value	Size	Vendor
C1,C4	100pF	0603	Samsung
C2,C3	12pF	0603	Samsung
R1	6.8Kohm	0603	Samsung
R2	0 ohm	0603	Samsung
L1	27nH	0603	Taiyo Yuden
L2	82nH	0603	Taiyo Yuden

500 – 1500 MHz High Linearity LNA

Package Outline Dimension

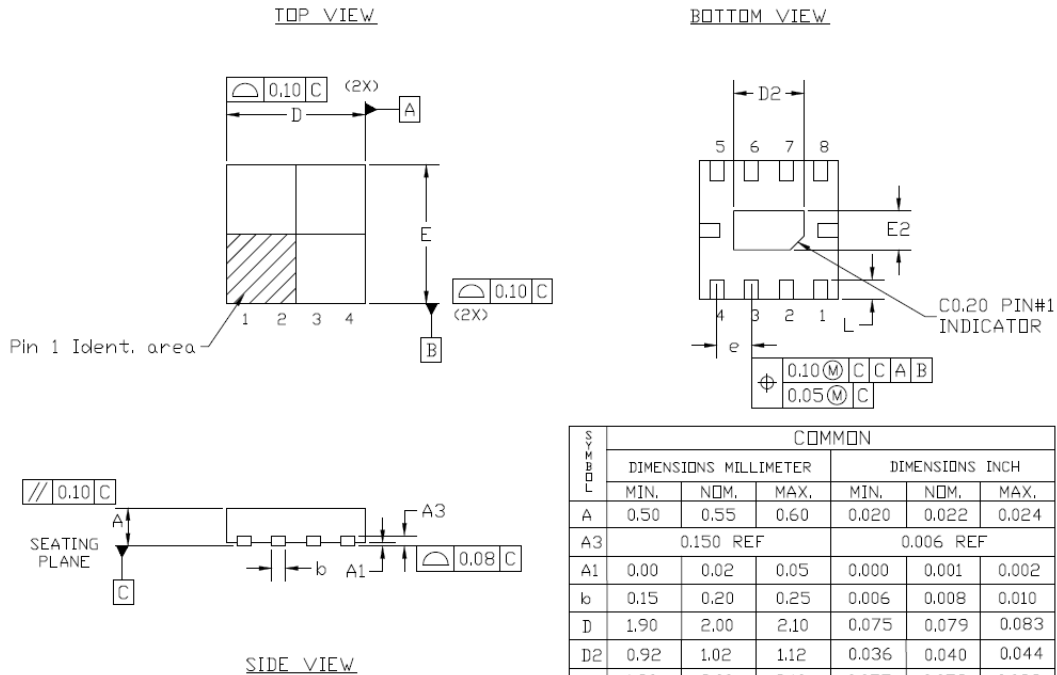

SYMBOL	COMMON					
	DIMENSIONS MILLIMETER			DIMENSIONS INCH		
	MIN.	NOM.	MAX.	MIN.	NOM.	MAX.
A	0.50	0.55	0.60	0.020	0.022	0.024
A3	0.150 REF			0.006 REF		
A1	0.00	0.02	0.05	0.000	0.001	0.002
b	0.15	0.20	0.25	0.006	0.008	0.010
D	1.90	2.00	2.10	0.075	0.079	0.083
D2	0.92	1.02	1.12	0.036	0.040	0.044
E	1.90	2.00	2.10	0.075	0.079	0.083
E2	0.46	0.56	0.66	0.018	0.022	0.026
e	0.50 BSC			0.020 BSC		
L	0.24	0.29	0.30	0.010	0.011	0.012

NOTES :

1. DIMENSION AND TOLERANCING CONFORM TO ASME Y14.5M-1994.
2. CONTROLLING DIMENSIONS : MILLIMETER, CONVERTED INCH DIMENSION ARE NOT NECESSARILY EXACT.

Suggested PCB Land Pattern and PAD Layout

PCB Land Pattern

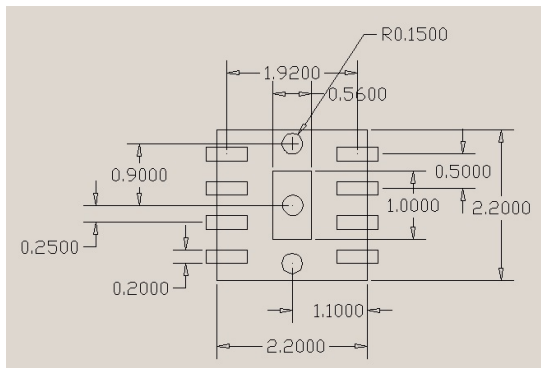

Note : All dimension _ millimeters

PCB lay out _ on BeRex website

PCB Mounting

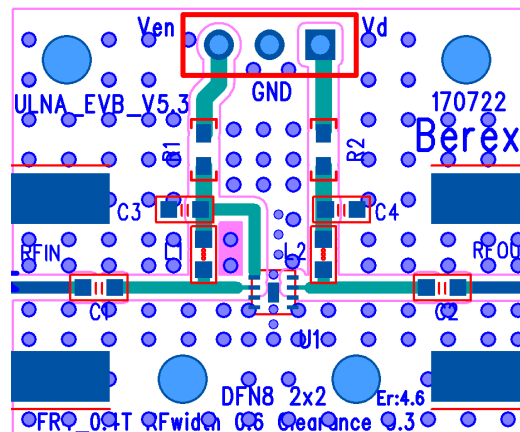

500 – 1500 MHz High Linearity LNA

Package Marking

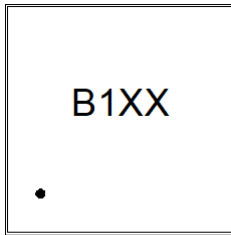

Pin 1

XX = Wafer No.

Tape & Reel

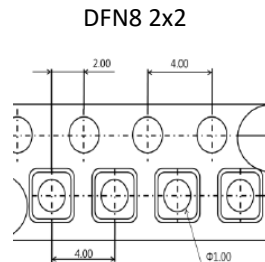

Packaging information:

Tape Width (mm): 8

Reel Size (inches): 7

Device Cavity Pitch (mm): 4

Devices Per Reel: 3000

Lead plating finish

100% Tin Matte finish

(All BeRex products undergoes a 1 hour, 150 degree C, Anneal bake to eliminate thin whisker growth concerns.)

MSL / ESD Rating

ESD Rating:	Class 1C
Value:	Passes <2000V
Test:	Human Body Model (HBM)
Standard:	JEDEC Standard JS-001-2014

MSL Rating:	Level 1 at +260°C convection reflow
Standard:	JEDEC Standard J-STD-020



Proper ESD procedures should be followed when handling this device.

500 – 1500 MHz High Linearity LNA

RoHS Compliance

This part is compliant with Restrictions on the Use of Certain Hazardous Substances in Electrical and Electronic Equipment (RoHS) Directive 2011/65/EU as amended by Directive 2015/863/EU.

This product also is compliant with a concentration of the Substances of Very High Concern (SVHC) candidate list which are contained in a quantity of less than 0.1%(w/w) in each components of a product and/or its packaging placed on the European Community market by the BeRex and Suppliers.

NATO CAGE code:

2	N	9	6	F
---	---	---	---	---