



# BGA7351

50 MHz to 500 MHz high linearity Si variable gain amplifier;  
28 dB gain range

Rev. 3 — 11 June 2014

Product data sheet

## 1. Product profile

### 1.1 General description

The BGA7351 MMIC is a dual independently digitally controlled IF Variable Gain Amplifier (VGA) operating from 50 MHz to 500 MHz. Each IF VGA amplifies with a gain range of 28 dB and at its maximum gain setting delivers 16.5 dBm output power at 1 dB gain compression and a superior linear performance.

The BGA7351 Dual IF VGA is optimized for a differential gain error of less than  $\pm 0.1$  dB for accurate gain control and has a total integrated gain error of less than  $\pm 0.3$  dB. Moreover it meets the demanding phase error requirements for GSM. BGA7351 has less than  $3.0^\circ$  phase error over the full gain range of 28 dB.

The gain controls of each amplifier are separate digital gain-control word, which is provided externally through two sets of 5 bits.

The BGA7351 is housed in a 32 pins 5 mm  $\times$  5 mm leadless HVQFN32 package.

### 1.2 Features and benefits

- Dual independent digitally controlled 28 dB gain range VGAs, with 5-bit control interface
- 50 MHz to 500 MHz frequency operating range
- Gain step size: 1 dB  $\pm$  0.1 dB
- 22 dB power gain
- Fast gain stage switching capability
- 16.5 dBm output power at 1 dB gain compression
- 46 dBm third order intercept point
- Constant third order intercept point over output power
- $-85$  dBc second harmonic level
- Excellent noise figure of 6 dB
- 5 V single supply operation with power-down control
- Logic-level shutdown control pin reduces supply current
- Excellent ESD protection at all pins
- Moisture sensitivity level 1
- Unconditionally stable
- Excellent differential integrated gain and phase error
- Compliant to Directive 2002/95/EC, regarding Restriction of Hazardous Substances (RoHS)



### 1.3 Applications

- Compatible with GSM / W-CDMA / WiMAX / LTE base-station infrastructure / multi carrier systems
- Multi channel receivers
- General use for ADC driver applications

### 1.4 Quick reference data

**Table 1. Quick reference data**

*A\_EN = "1"; B\_EN = "1" (VGA enabled). Typical values at V<sub>CC</sub> = 5 V; I<sub>CC</sub> = 280 mA; Tuned for f<sub>IF</sub> = 172 MHz; B = 60 MHz; T<sub>case</sub> = 25 °C; Differential input resistance matched to 150 Ω; Differential output resistance matched to 200 Ω; unless otherwise specified; see [Section 11 "Application information"](#).*

Symbol	Parameter	Conditions	Min	Typ	Max	Unit
V <sub>CC</sub>	supply voltage	V <sub>CC(A)</sub> + V <sub>CC(B)</sub>	4.75	5	5.25	V
I <sub>CC</sub>	supply current	I <sub>CC(A)</sub> + I <sub>CC(B)</sub>				
		A_EN = "0"; B_EN = "0"	-	3	5	mA
		A_EN = "1"; B_EN = "1"	-	280	300	mA
G <sub>p</sub>	power gain	maximum gain <a href="#">[1]</a>	21	22	23	dB
		minimum gain <a href="#">[2]</a>	-7	-6	-5	dB
R <sub>i(dif)</sub>	differential input resistance		120	150	180	Ω
R <sub>o(dif)</sub>	differential output resistance		140	180	220	Ω
NF	noise figure	maximum gain <a href="#">[1]</a>	-	6	7	dB
		increased rate per gain step	-	0.8	1	dB
IP <sub>3O</sub>	output third-order intercept point	gain step 14 <a href="#">[3][4]</a>	-	46	-	dBm
P <sub>L(1dB)</sub>	output power at 1 dB gain compression	upper 5 gain steps <a href="#">[1][5]</a>	-	16.5	-	dBm
α <sub>2H</sub>	second harmonic level	gain step 14 <a href="#">[4][6]</a>	-	-85	-	dBc
E <sub>G(dif)</sub>	differential gain error		-	± 0.1	-	dB
E <sub>φ(dif)</sub>	differential phase error	upper 12 dB gain range	-	1.0	-	deg
		per gain step (for all consecutive gain steps)	-	0.5	-	deg

[1] Maximum gain; gain code = 00000.

[2] Minimum gain; gain code = 11100.

[3] P<sub>L</sub> = 2 dBm per tone; spacing = 2 MHz (f<sub>1</sub> = 171 MHz; f<sub>2</sub> = 173 MHz)

[4] Gain code = 01110.

[5] Gain code = 00000, 00001, 00010, 00011, 00100.

[6] P<sub>L</sub> = 2 dBm one tone (f = 86 MHz; f<sub>meas</sub> = 172 MHz)

## 2. Pinning information

### 2.1 Pinning

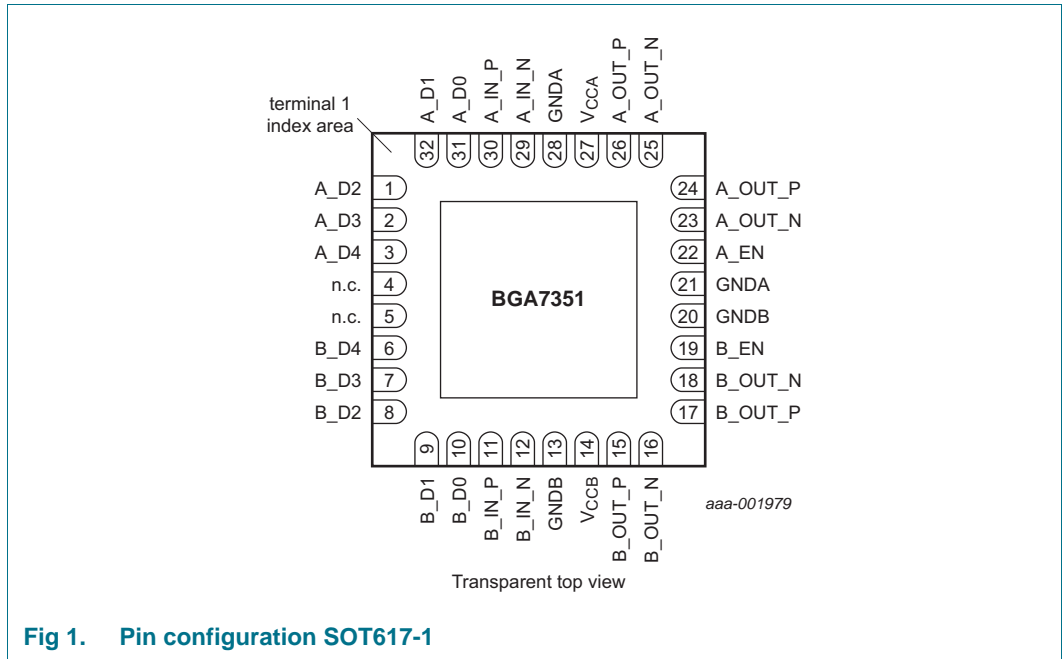

Fig 1. Pin configuration SOT617-1

### 2.2 Pin description

Table 2. Pin description

Symbol	Pin	Description
A_D2	1	MSB – 2 for gain control interface of channel A
A_D3	2	MSB – 1 for gain control interface of channel A
A_D4	3	MSB for gain control interface of channel A
n.c.	4	not connected [1]
n.c.	5	not connected [1]
B_D4	6	MSB for gain control interface of channel B
B_D3	7	MSB – 1 for gain control interface of channel B
B_D2	8	MSB – 2 for gain control interface of channel B
B_D1	9	LSB + 1 for gain control interface of channel B
B_D0	10	LSB for gain control interface of channel B
B_IN_P	11	channel B positive input [2]
B_IN_N	12	channel B negative input [2]
GNDB	13, 20	ground for channel B
V <sub>CCB</sub>	14	supply voltage for channel B
B_OUT_P	15, 17	channel B positive output [2]
B_OUT_N	16, 18	channel B negative output [2]
B_EN	19	power enable pin for channel B
GNDA	21, 28	ground for channel A

Table 2. Pin description ...continued

Symbol	Pin	Description
A_EN	22	power enable pin for channel A
A_OUT_N	23, 25	channel A negative output [2]
A_OUT_P	24, 26	channel A positive output [2]
V <sub>CCA</sub>	27	supply voltage for channel A
A_IN_N	29	channel A negative input [2]
A_IN_P	30	channel A positive input [2]
A_D0	31	LSB for gain control interface of channel A
A_D1	32	LSB + 1 for gain control interface of channel A
GND	GND paddle	RF ground and DC ground [3]

[1] Pin to be left open.

[2] Each channel should be independently enabled with logic HIGH and disabled with logic LOW.

[3] The center metal base of the SOT617-1 also functions as heatsink for the VGA.

### 3. Ordering information

Table 3. Ordering information

Type number	Package		Version
	Name	Description	
BGA7351	HVQFN32	plastic thermal enhanced very thin quad flat package; no leads; 32 terminals; body 5 × 5 × 0.85 mm	SOT617-1

**4. Functional diagram**

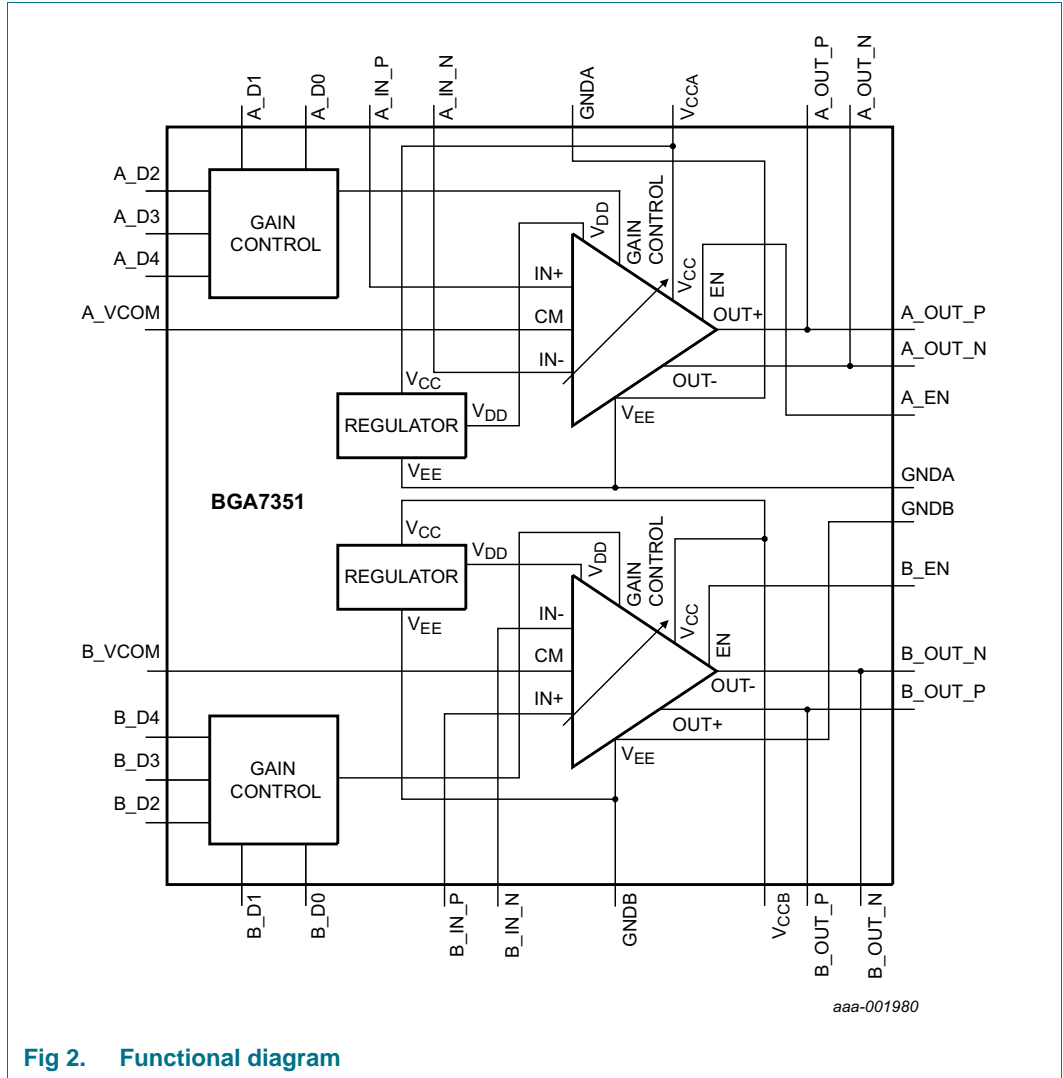

**Fig 2. Functional diagram**

**5. Enable control**

**Table 4. Enable / disable control settings**

Mode	Function description	Mode description	Enable		V <sub>EN</sub> (V)		I <sub>EN</sub> (μA)	
			A_EN	B_EN	Min	Max	Min	Max
A_EN, B_EN	VGA function off	disable	"0"	"0"	0	0.8	-	1
A_EN, B_EN	VGA in operating mode	enable	"1"	"1"	1.6	5.25	-	1

## 6. Limiting values

**Table 5. Limiting values**

In accordance with the Absolute Maximum Rating System (IEC 60134).

Symbol	Parameter	Conditions	Min	Max	Unit
$V_{CC(A)}$	supply voltage (A)	[1]	-	6	V
$V_{CC(B)}$	supply voltage (B)	[1]	-	6	V
$V_{AEN}$	voltage on pin A_EN		-0.6	+6	V
$V_{BEN}$	voltage on pin B_EN		-0.6	+6	V
$V_{AD0}$	voltage on pin A_D0		-0.6	+6	V
$V_{AD1}$	voltage on pin A_D1		-0.6	+6	V
$V_{AD2}$	voltage on pin A_D2		-0.6	+6	V
$V_{AD3}$	voltage on pin A_D3		-0.6	+6	V
$V_{AD4}$	voltage on pin A_D4		-0.6	+6	V
$V_{BD0}$	voltage on pin B_D0		-0.6	+6	V
$V_{BD1}$	voltage on pin B_D1		-0.6	+6	V
$V_{BD2}$	voltage on pin B_D2		-0.6	+6	V
$V_{BD3}$	voltage on pin B_D3		-0.6	+6	V
$V_{BD4}$	voltage on pin B_D4		-0.6	+6	V
$V_{AIN}$	voltage on pin A_IN		-0.6	+6	V
$V_{BIN}$	voltage on pin B_IN		-0.6	+6	V
$P_{i(RF)}$	RF input power		-	20	dBm
$T_{case}$	case temperature		-40	+85	°C
$T_j$	junction temperature		-	150	°C
$V_{ESD}$	electrostatic discharge voltage	Human Body Model (HBM); According JEDEC standard 22-A114E	-	4000	V
		Charged Device Model (CDM); According JEDEC standard 22-C101B	-	2000	V
		Machine Model (MM); According JEDEC standard 22-A115	-	400	V

[1] Caution: All digital pins may not exceed  $V_{CC}$  as the internal ESD circuit can be damaged. To prevent this it is recommended that  $V_{AEN}$  and  $V_{BEN}$  are limited to a maximum of 5 mA.

## 7. Thermal characteristics

**Table 6. Thermal characteristics**

Symbol	Parameter	Conditions	Typ	Unit
$R_{th(j-case)}$	thermal resistance from junction to case	$T_{case} = 85\text{ °C}$ ; $V_{CC} = 5\text{ V}$ ; $I_{CC} = 280\text{ mA}$	7	K/W

## 8. Static characteristics

**Table 7. Characteristics**

$A\_EN = "1"$ ;  $B\_EN = "1"$  (both channels enabled). Typical values at  $V_{CC} = 5\text{ V}$ ;  $T_{case} = 25\text{ }^{\circ}\text{C}$ ; unless otherwise specified.

Symbol	Parameter	Conditions	Min	Typ	Max	Unit
$V_{CC}$	supply voltage	$V_{CC(A)} + V_{CC(B)}$	4.75	5	5.25	V
$I_{CC}$	supply current	$I_{CC(A)} + I_{CC(B)}$				
		$A\_EN = "0"$ ; $B\_EN = "0"$	-	3	5	mA
		$A\_EN = "1"$ ; $B\_EN = "1"$	-	280	300	mA
$V_{IH}$	HIGH-level input voltage	[1]	1.6	-	5.25	V
$V_{IL}$	LOW-level input voltage	[1]	-	-	0.8	V
P	power dissipation		-	1.4	1.6	W

[1] Voltage on the control pins.

## 9. Dynamic characteristics

**Table 8. Characteristics**

$A\_EN = "1"$ ;  $B\_EN = "1"$  (VGA enabled). Typical values at  $V_{CC} = 5\text{ V}$ ;  $I_{CC} = 280\text{ mA}$ ; Tuned for  $f_{IF} = 172\text{ MHz}$ ;  $B = 60\text{ MHz}$ ;  $T_{case} = 25\text{ }^{\circ}\text{C}$ ; Differential input resistance matched to  $150\text{ }\Omega$ ; Differential output resistance matched to  $200\text{ }\Omega$ ; unless otherwise specified; see [Section 11 "Application information"](#).

Symbol	Parameter	Conditions	Min	Typ	Max	Unit
$G_p$	power gain	maximum gain [1]				
		$f = 50\text{ MHz}$ ; $B = 30\text{ MHz}$	-	22.5	-	dB
		$f = 172\text{ MHz}$ ; $B = 60\text{ MHz}$	21	22	23	dB
		$f = 250\text{ MHz}$ ; $B = 60\text{ MHz}$	-	21.5	-	dB
		$f = 450\text{ MHz}$ ; $B = 100\text{ MHz}$	-	21.5	-	dB
		minimum gain [2]				
		$f = 50\text{ MHz}$ ; $B = 30\text{ MHz}$	-	-5.5	-	dB
		$f = 172\text{ MHz}$ ; $B = 60\text{ MHz}$	-7	-6	-5	dB
		$f = 250\text{ MHz}$ ; $B = 60\text{ MHz}$	-	-6.5	-	dB
$f = 450\text{ MHz}$ ; $B = 100\text{ MHz}$	-	-8	-	dB		
$\Delta G_{adj}$	gain adjustment range	[1]	-	28	-	dB
$G_{step}$	gain step		-	1	-	
$G_{flat}$	gain flatness	[1]	-	$\pm 0.5$	-	dB
$E_{G(dif)}$	differential gain error		-	$\pm 0.1$	-	dB
$E_{G(itg)}$	integrated gain error	upper 12 dB gain range	-	$\pm 0.2$	-	dB
		full gain range	-	$\pm 0.3$	-	dB
$E_{\phi(dif)}$	differential phase error	upper 12 dB gain range	-	1.0	-	deg
		per gain step (for all consecutive gain steps)	-	0.5	-	deg
		full gain range	-	3.0	-	deg
$t_{s(step)G}$	gain step settling time	per 1.5 dB of steady state	-	5	15	ns
		per 0.1 dB of steady state	-	20	40	ns

**Table 8. Characteristics ...continued**

$A\_EN = "1"$ ;  $B\_EN = "1"$  (VGA enabled). Typical values at  $V_{CC} = 5\text{ V}$ ;  $I_{CC} = 280\text{ mA}$ ; Tuned for  $f_{IF} = 172\text{ MHz}$ ;  $B = 60\text{ MHz}$ ;  $T_{case} = 25\text{ }^{\circ}\text{C}$ ; Differential input resistance matched to  $150\text{ }\Omega$ ; Differential output resistance matched to  $200\text{ }\Omega$ ; unless otherwise specified; see [Section 11](#) "Application information".

Symbol	Parameter	Conditions	Min	Typ	Max	Unit
$\Delta t_{d(\text{grp})}$	group delay time variation	$B = 30\text{ MHz}$	-	86	-	ps
$t_{\text{pu}}$	power-up time		-	-	1	$\mu\text{s}$
$R_{i(\text{dif})}$	differential input resistance		120	150	180	$\Omega$
$R_{o(\text{dif})}$	differential output resistance		140	180	220	$\Omega$
$\alpha_{\text{isol}(\text{ch-ch})}$	isolation between channels	$f \leq 250\text{ MHz}$	50	-	-	dB
		$250\text{ MHz} < f < 400\text{ MHz}$	47	-	-	dB
		$400\text{ MHz} \leq f \leq 500\text{ MHz}$	45	-	-	dB
CMRR	common-mode rejection ratio		40	-	-	dB
IP3 <sub>O</sub>	output third-order intercept point	gain step 14 <a href="#">[3]</a>				
		$f = 50\text{ MHz}$ <a href="#">[4]</a>	-	47	-	dBm
		$f = 172\text{ MHz}$ <a href="#">[5]</a>	-	46	-	dBm
		$f = 250\text{ MHz}$ <a href="#">[6]</a>	-	41	-	dBm
		$f = 450\text{ MHz}$ <a href="#">[7]</a>	-	34	-	dBm
		upper 5 gain steps <a href="#">[8]</a>				
		$f = 50\text{ MHz}$ <a href="#">[4]</a>	-	48	-	dBm
		$f = 172\text{ MHz}$ <a href="#">[5]</a>	-	44	-	dBm
		$f = 250\text{ MHz}$ <a href="#">[6]</a>	-	41	-	dBm
		$f = 450\text{ MHz}$ <a href="#">[7]</a>	-	33	-	dBm
IP2 <sub>O</sub>	output second-order intercept point	upper 5 gain steps <a href="#">[8]</a>				
		$f = 50\text{ MHz}$ <a href="#">[9]</a>	-	78	-	dBm
		$f = 172\text{ MHz}$ <a href="#">[10]</a>	-	73	-	dBm
		$f = 250\text{ MHz}$ <a href="#">[11]</a>	-	65	-	dBm
P <sub>L(1dB)</sub>	output power at 1 dB gain compression	upper 5 gain steps <a href="#">[8]</a>				
		$f = 50\text{ MHz}$	-	16.8	-	dBm
		$f = 172\text{ MHz}$	-	16.5	-	dBm
		$f = 250\text{ MHz}$	-	15.8	-	dBm
		$f = 450\text{ MHz}$	-	15.1	-	dBm



**Table 8. Characteristics ...continued**

$A\_EN = "1"$ ;  $B\_EN = "1"$  (VGA enabled). Typical values at  $V_{CC} = 5\text{ V}$ ;  $I_{CC} = 280\text{ mA}$ ; Tuned for  $f_{IF} = 172\text{ MHz}$ ;  $B = 60\text{ MHz}$ ;  $T_{case} = 25\text{ }^\circ\text{C}$ ; Differential input resistance matched to  $150\text{ }\Omega$ ; Differential output resistance matched to  $200\text{ }\Omega$ ; unless otherwise specified; see [Section 11](#) "Application information".

Symbol	Parameter	Conditions	Min	Typ	Max	Unit
$\alpha_{2H}$	second harmonic level	gain step 14 <a href="#">[3]</a>				
		$P_L = 2\text{ dBm}$ , $f = 172\text{ MHz}$ <a href="#">[12]</a>	-	-85	-	dBc
		$P_L = 5\text{ dBm}$ , $f = 172\text{ MHz}$ <a href="#">[13]</a>	-	-82	-	dBc
		$P_L = 2\text{ dBm}$ , $f = 450\text{ MHz}$ <a href="#">[14]</a>	-	-67	-	dBc
		$P_L = 5\text{ dBm}$ , $f = 450\text{ MHz}$ <a href="#">[15]</a>	-	-64	-	dBc
		upper 5 gain steps <a href="#">[8]</a>				
		$P_L = 2\text{ dBm}$ , $f = 172\text{ MHz}$ <a href="#">[12]</a>	-	-83	-	dBc
		$P_L = 5\text{ dBm}$ , $f = 172\text{ MHz}$ <a href="#">[13]</a>	-	-80	-	dBc
		$P_L = 2\text{ dBm}$ , $f = 450\text{ MHz}$ <a href="#">[14]</a>	-	-59	-	dBc
		$P_L = 5\text{ dBm}$ , $f = 450\text{ MHz}$ <a href="#">[15]</a>	-	-54	-	dBc
NF	noise figure	maximum gain <a href="#">[1]</a>	-	6	7	dB
		increase rate per gain step	-	0.8	1	dB

- [1] Maximum gain; gain code = 00000.
- [2] Minimum gain; gain code = 11100.
- [3] Gain code = 01110.
- [4]  $P_L = 2\text{ dBm}$  per tone; spacing =  $2\text{ MHz}$  ( $f_1 = 49\text{ MHz}$ ;  $f_2 = 51\text{ MHz}$ )
- [5]  $P_L = 2\text{ dBm}$  per tone; spacing =  $2\text{ MHz}$  ( $f_1 = 171\text{ MHz}$ ;  $f_2 = 173\text{ MHz}$ )
- [6]  $P_L = 2\text{ dBm}$  per tone; spacing =  $2\text{ MHz}$  ( $f_1 = 249\text{ MHz}$ ;  $f_2 = 251\text{ MHz}$ )
- [7]  $P_L = 2\text{ dBm}$  per tone; spacing =  $2\text{ MHz}$  ( $f_1 = 449\text{ MHz}$ ;  $f_2 = 451\text{ MHz}$ )
- [8] Gain code = 00000, 00001, 00010, 00011, 00100.
- [9]  $P_L = 2\text{ dBm}$  per tone ( $f_1 = 24\text{ MHz}$ ;  $f_2 = 74\text{ MHz}$ ;  $f_{meas} = 50\text{ MHz}$ )
- [10]  $P_L = 2\text{ dBm}$  per tone ( $f_1 = 82\text{ MHz}$ ;  $f_2 = 90\text{ MHz}$ ;  $f_{meas} = 172\text{ MHz}$ )
- [11]  $P_L = 2\text{ dBm}$  per tone ( $f_1 = 120\text{ MHz}$ ;  $f_2 = 130\text{ MHz}$ ;  $f_{meas} = 250\text{ MHz}$ )
- [12]  $P_L = 2\text{ dBm}$  one tone ( $f = 86\text{ MHz}$ ;  $f_{meas} = 172\text{ MHz}$ )
- [13]  $P_L = 5\text{ dBm}$  one tone ( $f = 86\text{ MHz}$ ;  $f_{meas} = 172\text{ MHz}$ )
- [14]  $P_L = 2\text{ dBm}$  one tone ( $f = 225\text{ MHz}$ ;  $f_{meas} = 450\text{ MHz}$ )
- [15]  $P_L = 5\text{ dBm}$  one tone ( $f = 225\text{ MHz}$ ;  $f_{meas} = 450\text{ MHz}$ )

Table 9. Gain control

gain step	input to either A_D0 to A_D4 pins or B_D0 to B_D4 pins	nominal power gain (dB)
0	00000	22
1	00001	21
2	00010	20
3	00011	19
4	00100	18
5	00101	17
6	00110	16
7	00111	15
8	01000	14
9	01001	13
10	01010	12
11	01011	11
12	01100	10
13	01101	9
14	01110	8
15	01111	7
16	10000	6
17	10001	5
18	10010	4
19	10011	3
20	10100	2
21	10101	1
22	10110	0
23	10111	-1
24	11000	-2
25	11001	-3
26	11010	-4
27	11011	-5
28	11100	-6
-	> 11100	-6

## 10. Moisture sensitivity

Table 10. Moisture sensitivity level

Test methodology	Class
JESD-22-A113	1

11. Application information

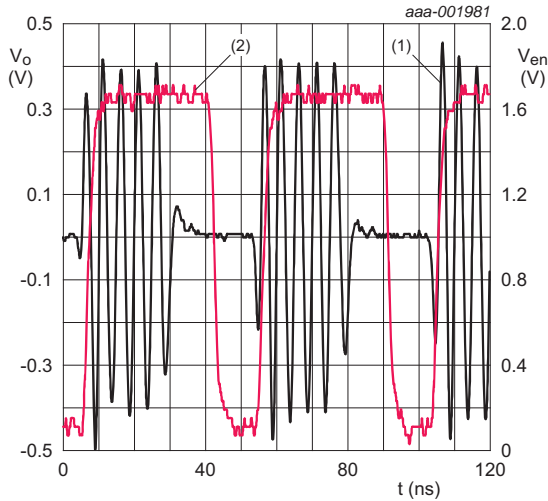

- (1)  $V_O$
- (2)  $V_{en}$

Fig 3. Enable time response

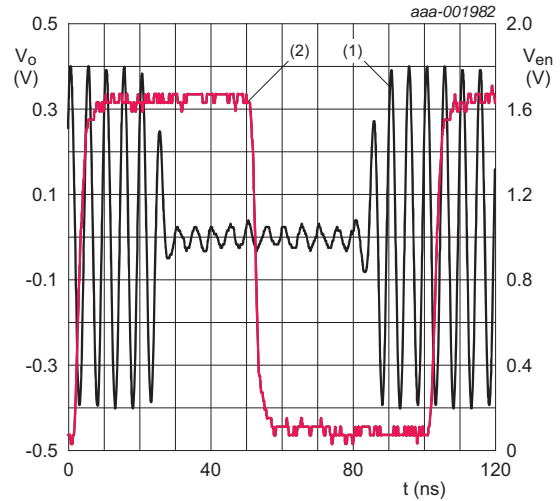

- (1)  $V_O$
- (2)  $V_{en}$

Fig 4. Gain step response from min. to max. gain

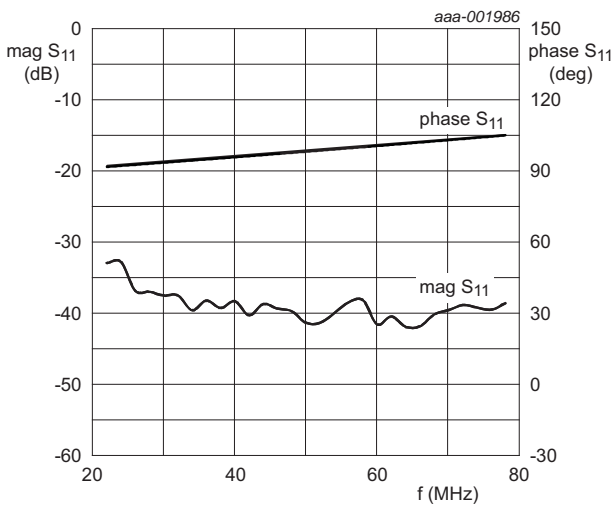

Tuned for  $f_{IF} = 50$  MHz; measured at gain step 0 (maximum gain).

Fig 5.  $S_{11}$  as a function of frequency

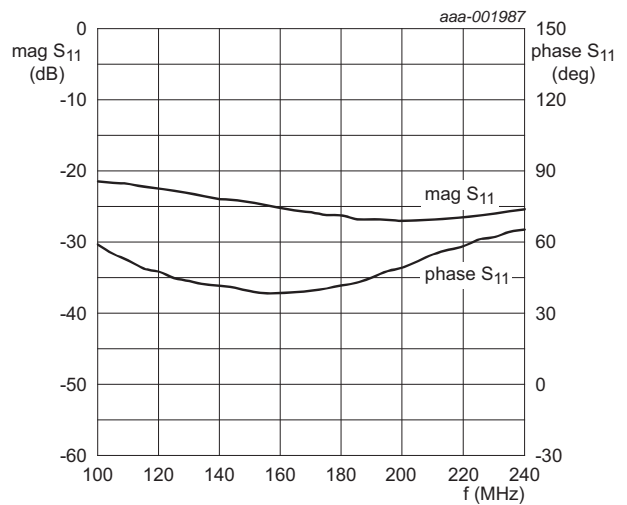

Tuned for  $f_{IF} = 172$  MHz; measured at gain step 0 (maximum gain).

Fig 6.  $S_{11}$  as a function of frequency

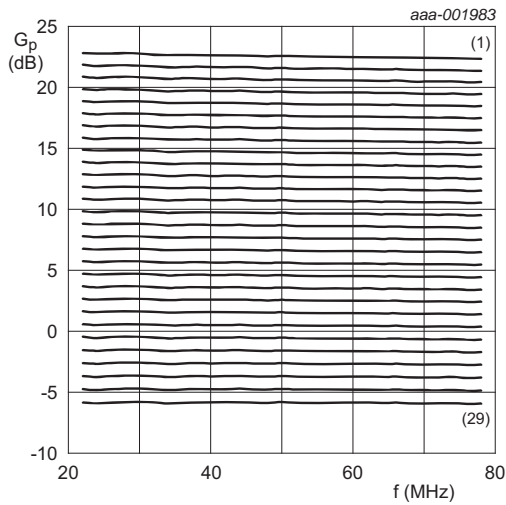

Tuned for  $f_{IF} = 50$  MHz;  $P_L = 5$  dBm; step size 1 dB.  
 (1) gain step 0 (maximum gain)  
 (29) gain step 28 (minimum gain)

**Fig 7. Power gain as a function of frequency**

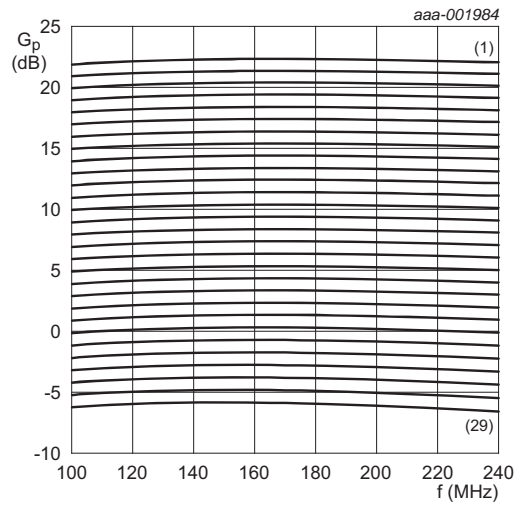

Tuned for  $f_{IF} = 172$  MHz;  $P_L = 5$  dBm; step size 1 dB.  
 (1) gain step 0 (maximum gain)  
 (29) gain step 28 (minimum gain)

**Fig 8. Power gain as a function of frequency**

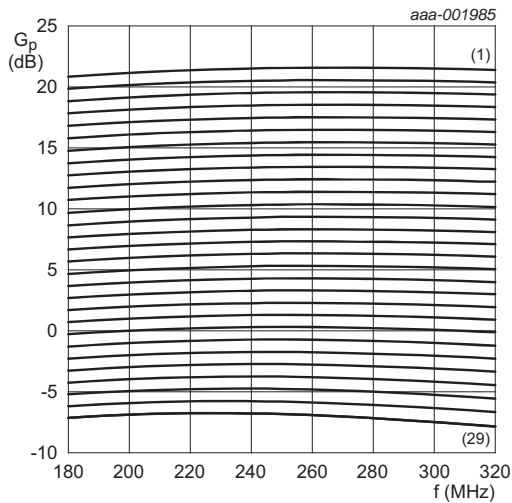

Tuned for  $f_{IF} = 250$  MHz;  $P_L = 5$  dBm; step size 1 dB.  
 (1) gain step 0 (maximum gain)  
 (29) gain step 28 (minimum gain)

**Fig 9. Power gain as a function of frequency**

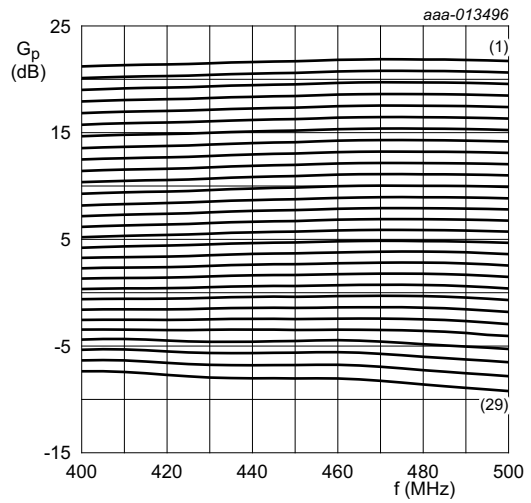

Tuned for  $f_{IF} = 450$  MHz;  $P_L = 5$  dBm; step size 1 dB.  
 (1) gain step 0 (maximum gain)  
 (29) gain step 28 (minimum gain)

**Fig 10. Power gain as a function of frequency**

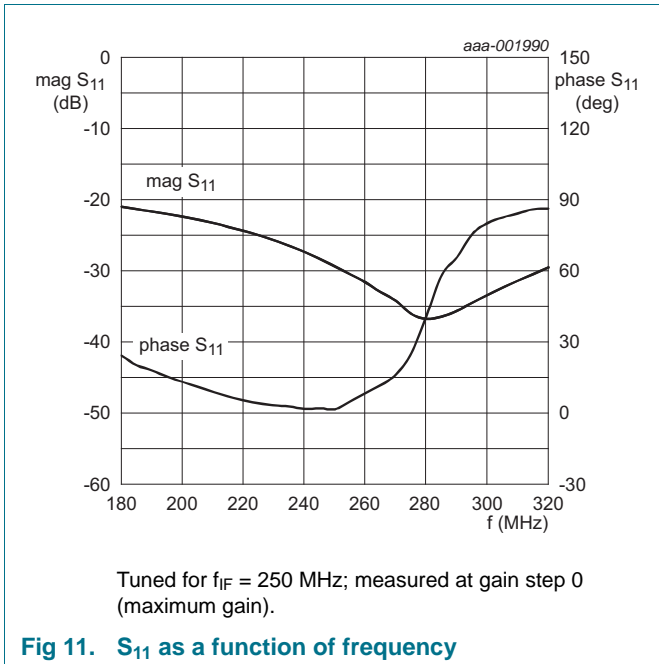

Fig 11.  $S_{11}$  as a function of frequency

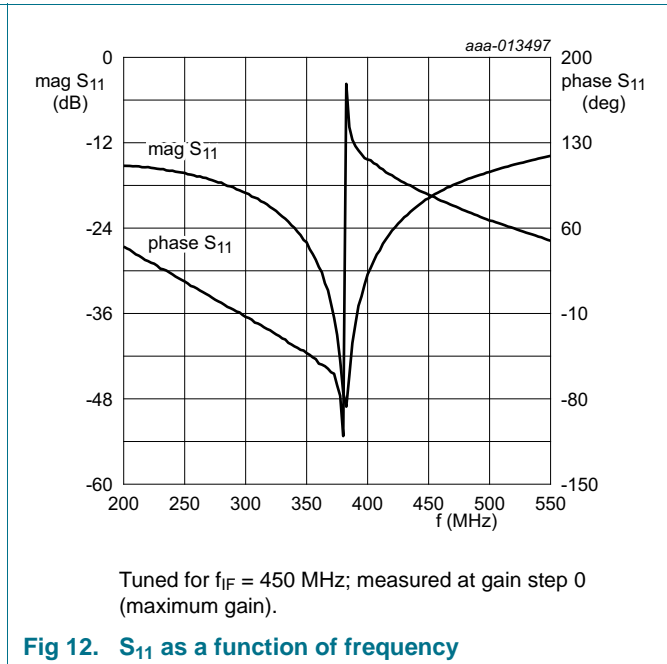

Fig 12.  $S_{11}$  as a function of frequency

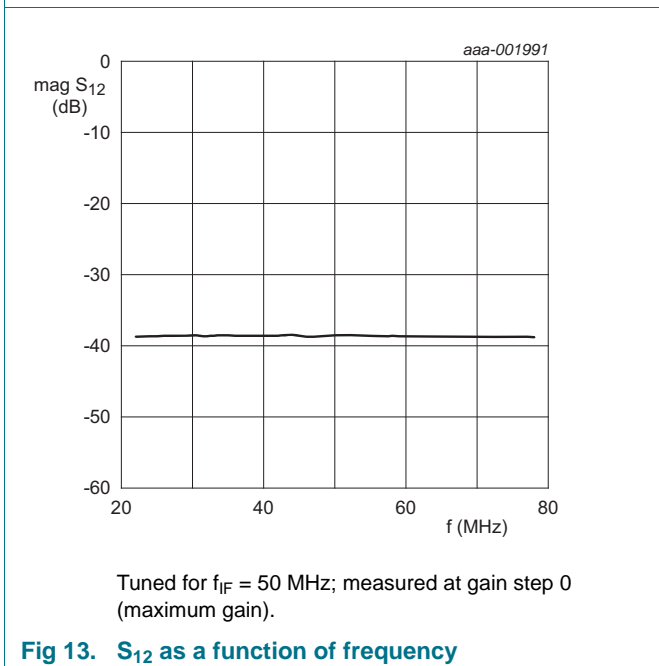

Fig 13.  $S_{12}$  as a function of frequency

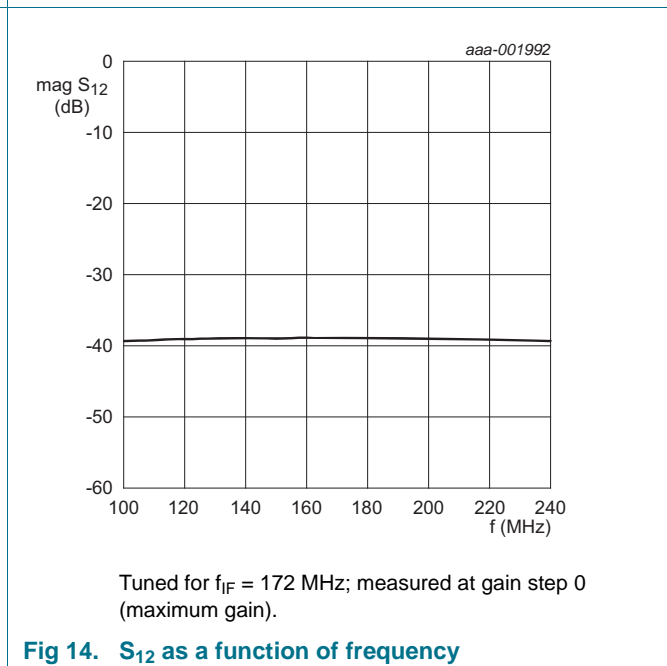

Fig 14.  $S_{12}$  as a function of frequency

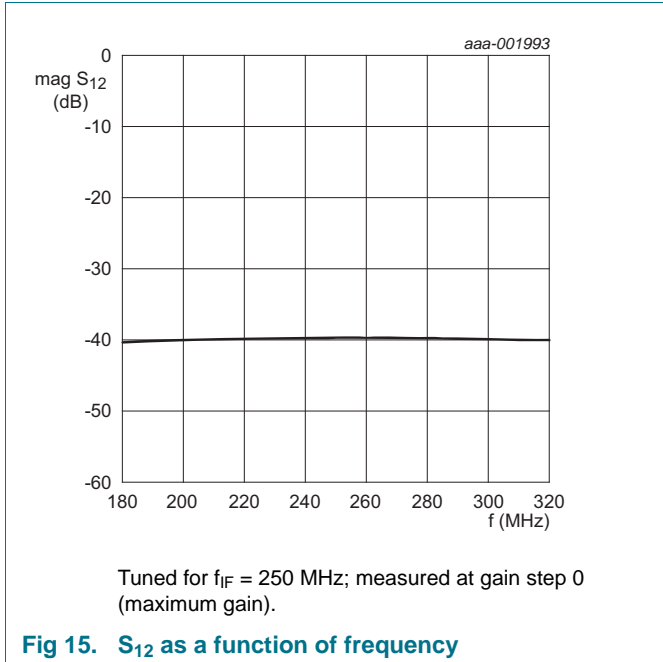

Fig 15.  $S_{12}$  as a function of frequency

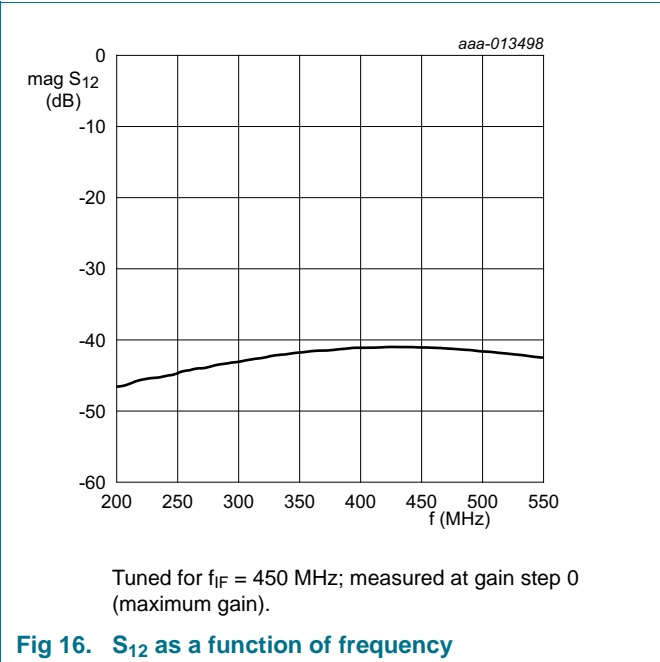

Fig 16.  $S_{12}$  as a function of frequency

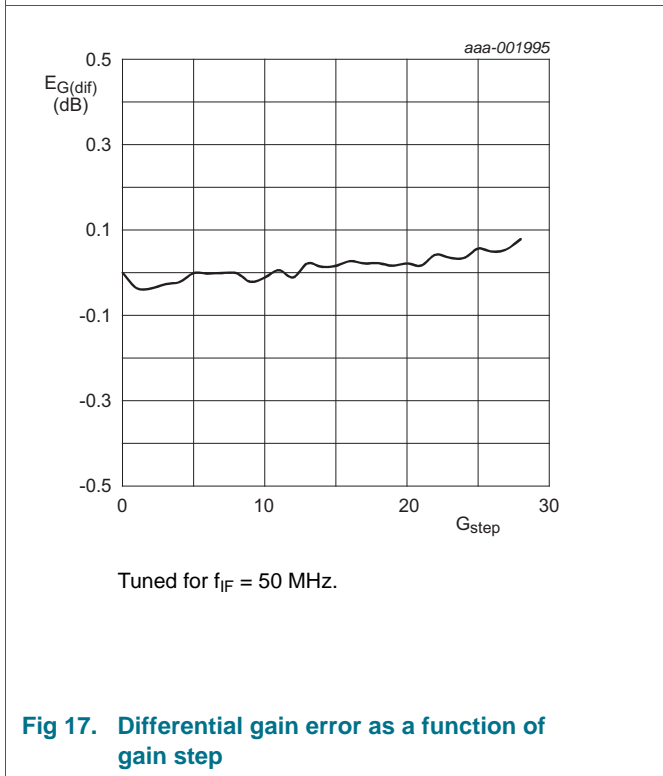

Fig 17. Differential gain error as a function of gain step

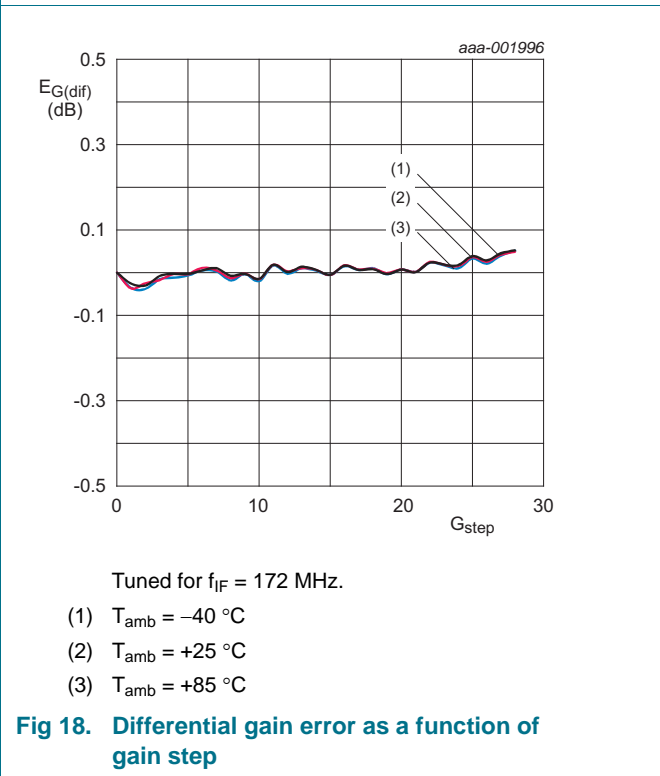
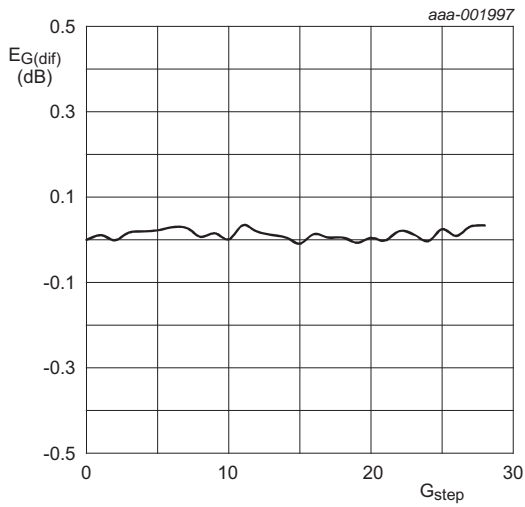
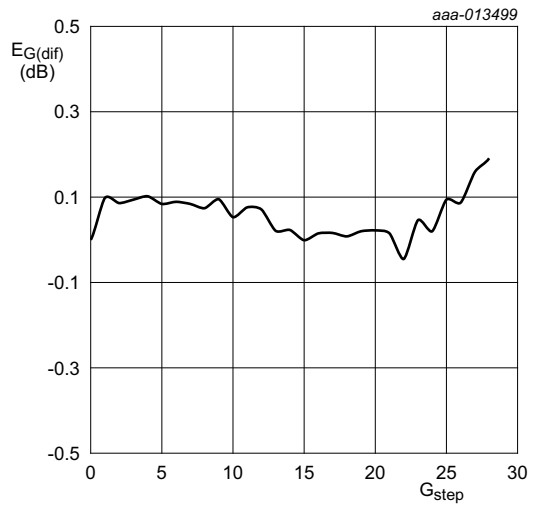

Fig 18. Differential gain error as a function of gain step



Tuned for  $f_{IF} = 250$  MHz.

**Fig 19. Differential gain error as a function of gain step**



Tuned for  $f_{IF} = 450$  MHz.

**Fig 20. Differential gain error as a function of gain step**

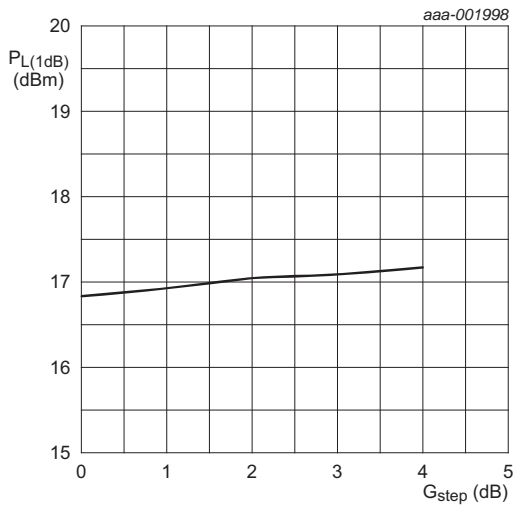

Tuned for  $f_{IF} = 50$  MHz.

**Fig 21. output power at 1 dB gain compression as a function of gain step**

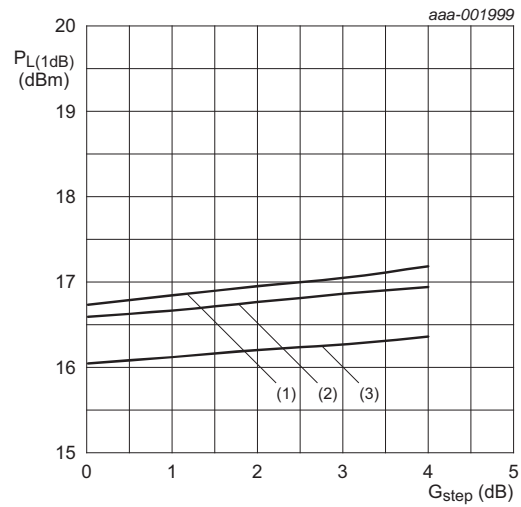

Tuned for  $f_{IF} = 172$  MHz.

- (1)  $T_{\text{amb}} = -40$  °C
- (2)  $T_{\text{amb}} = +25$  °C
- (3)  $T_{\text{amb}} = +85$  °C

**Fig 22. output power at 1 dB gain compression as a function of gain step**

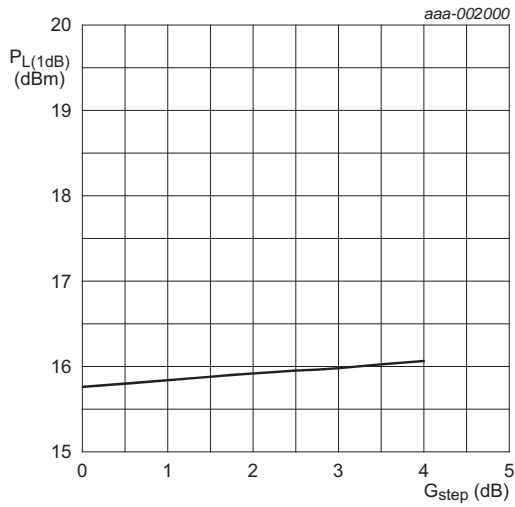

Tuned for  $f_{IF} = 250$  MHz.

**Fig 23.** output power at 1 dB gain compression as a function of gain step

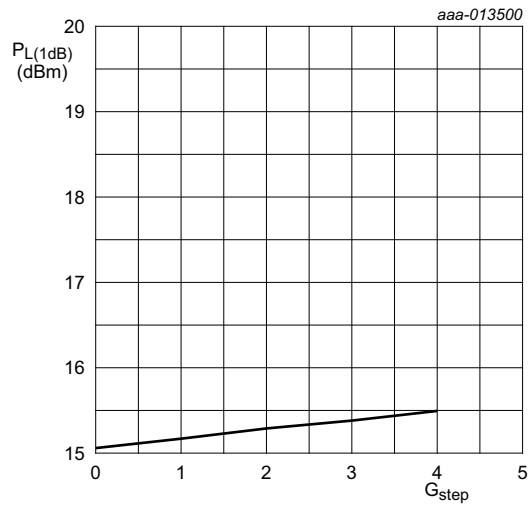

Tuned for  $f_{IF} = 450$  MHz.

**Fig 24.** output power at 1 dB gain compression as a function of gain step

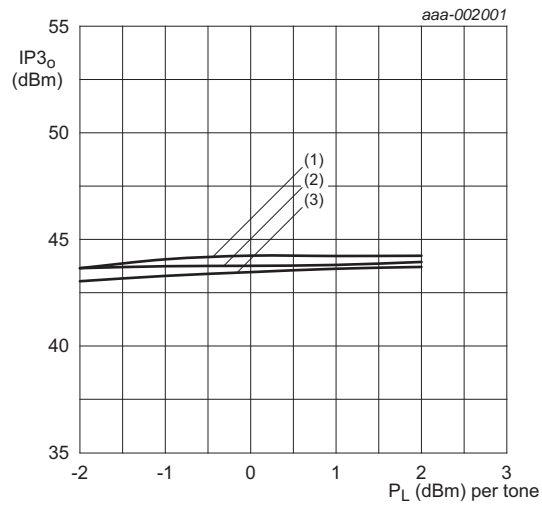

Tuned for  $f_{IF} = 172$  MHz; measured at gain step 0 (maximum gain).

- (1)  $T_{amb} = -40$  °C
- (2)  $T_{amb} = +25$  °C
- (3)  $T_{amb} = +85$  °C

**Fig 25.** Output third order intercept point as a function of output power per tone



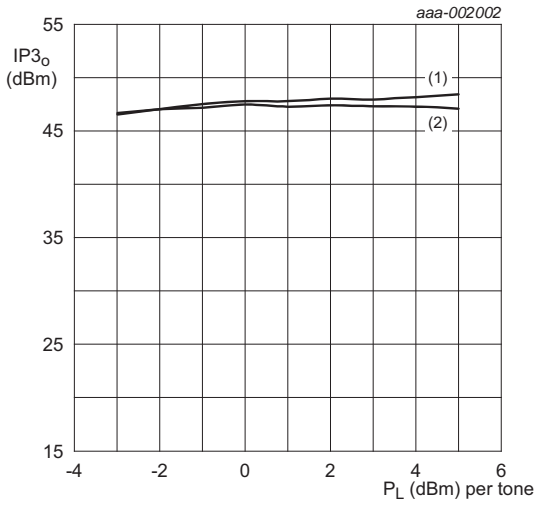

Tuned for  $f_{IF} = 50$  MHz.  
 (1) gain step 0  
 (2) gain step 14

**Fig 26. Output third order intercept point as a function of output power per tone**

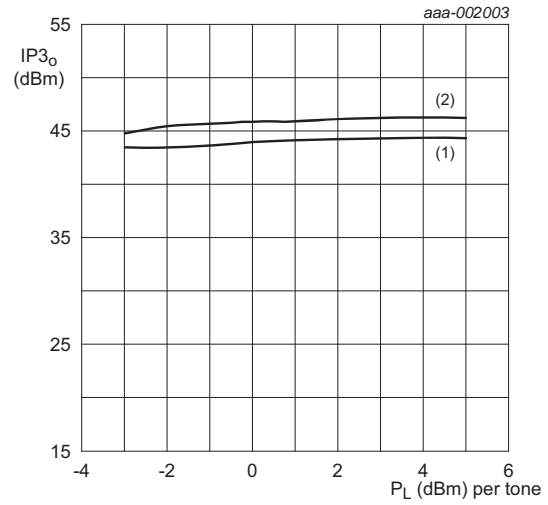

Tuned for  $f_{IF} = 172$  MHz.  
 (1) gain step 0  
 (2) gain step 14

**Fig 27. Output third order intercept point as a function of output power per tone**

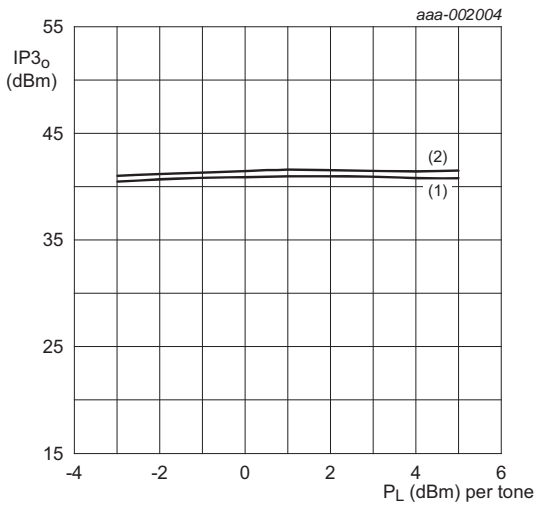

Tuned for  $f_{IF} = 250$  MHz.  
 (1) gain step 0  
 (2) gain step 14

**Fig 28. Output third order intercept point as a function of output power per tone**

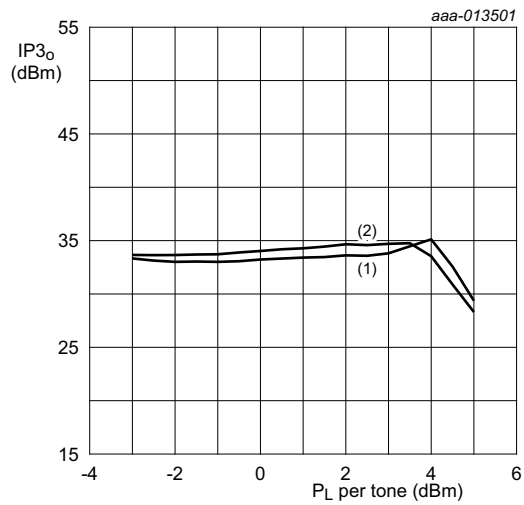

Tuned for  $f_{IF} = 450$  MHz.  
 (1) gain step 0  
 (2) gain step 14

**Fig 29. Output third order intercept point as a function of output power per tone**

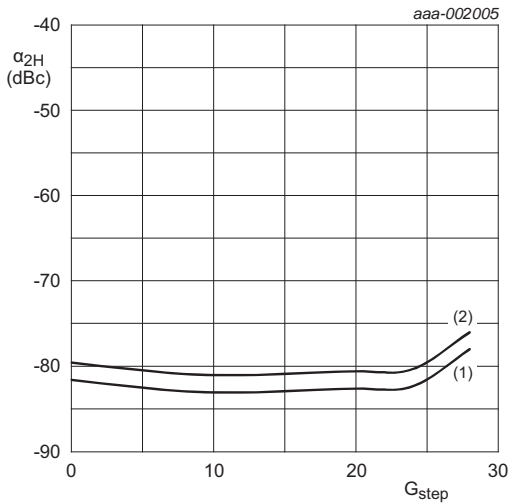

Tuned for  $f_{IF} = 86$  MHz;  $f_{2H} = 172$  MHz;  $f_{3H} = 258$  MHz.  
 (1)  $P_L = 2$  dBm  
 (2)  $P_L = 5$  dBm

**Fig 30. Second harmonic level as a function of gain step**

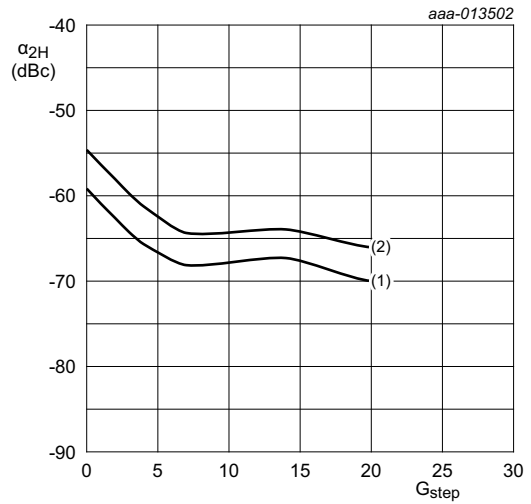

Tuned for  $f_{IF} = 225$  MHz;  $f_{2H} = 450$  MHz;  $f_{3H} = 675$  MHz.  
 (1)  $P_L = 2$  dBm  
 (2)  $P_L = 5$  dBm

**Fig 31. Second harmonic level as a function of gain step**

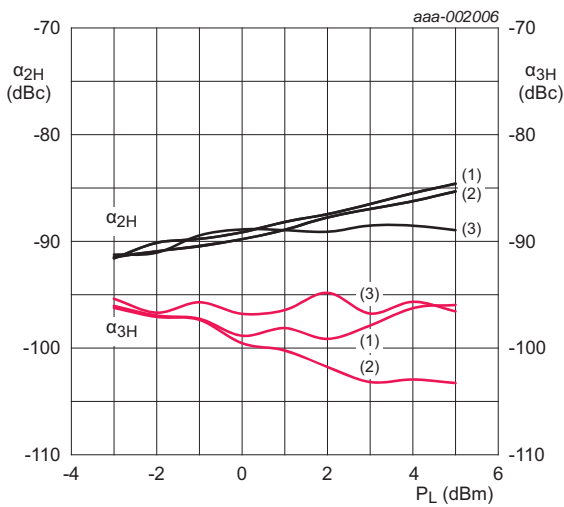

Tuned for  $f_{IF} = 50$  MHz;  $f_{2H} = 100$  MHz;  $f_{3H} = 150$  MHz;  $T_{amb} = 25$  °C.  
 (1) gain step 0  
 (2) gain step 14  
 (3) gain step 24

**Fig 32. Second harmonic level and third harmonic level as a function of output power**

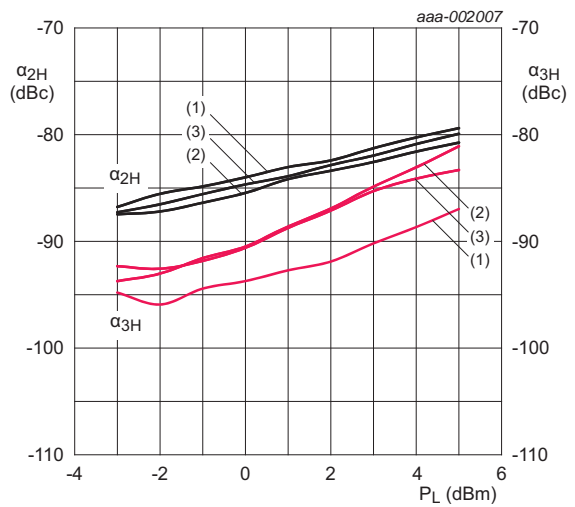

Tuned for  $f_{IF} = 86$  MHz;  $f_{2H} = 172$  MHz;  $f_{3H} = 258$  MHz;  $T_{amb} = 25$  °C.  
 (1) gain step 0  
 (2) gain step 14  
 (3) gain step 24

**Fig 33. Second harmonic level and third harmonic level as a function of output power**

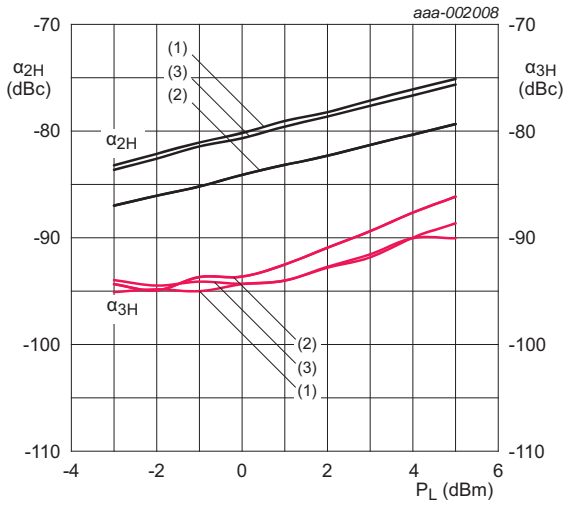

Tuned for  $f_{IF} = 172$  MHz;  $f_{2H} = 358$  MHz;  $f_{3H} = 530$  MHz;  $T_{amb} = 25$  °C.

- (1) gain step 0
- (2) gain step 14
- (3) gain step 24

**Fig 34. Second harmonic level and third harmonic level as a function of output power**

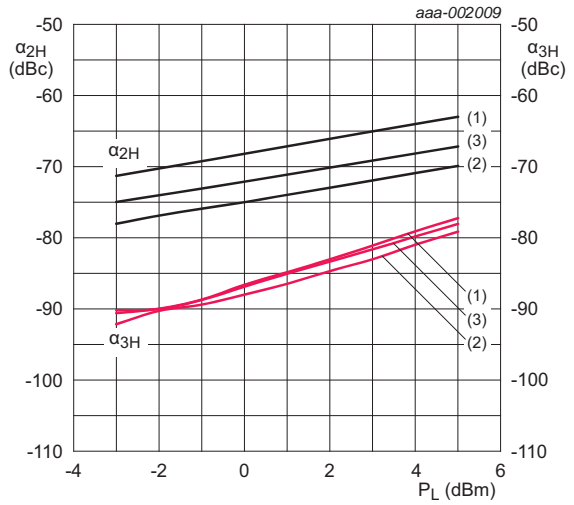

Tuned for  $f_{IF} = 250$  MHz;  $f_{2H} = 500$  MHz;  $f_{3H} = 750$  MHz;  $T_{amb} = 25$  °C.

- (1) gain step 0
- (2) gain step 14
- (3) gain step 24

**Fig 35. Second harmonic level and third harmonic level as a function of output power**

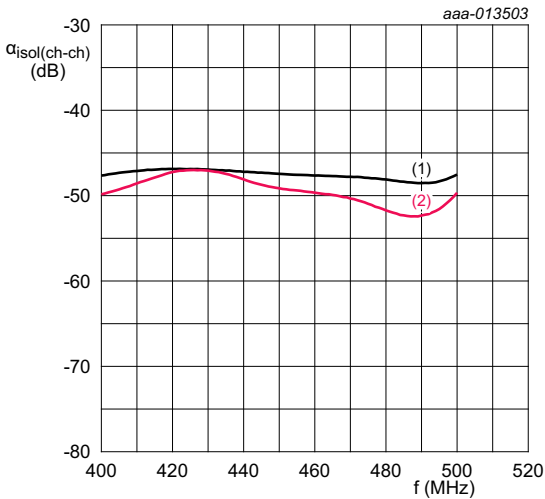

Tuned for  $f_{IF} = 450$  MHz

- (1) channel A at gain step 0 (maximum gain); channel B at gain step 28 (minimum gain)
- (2) channel A at gain step 0 (maximum gain); channel B at gain step 0 (maximum gain)

**Fig 36. Isolation between channels as a function of frequency**

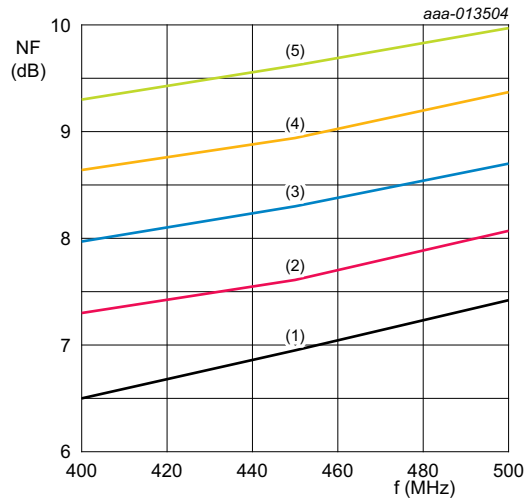

Tuned for  $f_{IF} = 450$  MHz

- (1) gain step 0
- (2) gain step 1
- (3) gain step 2
- (4) gain step 3
- (5) gain step 4

**Fig 37. Noise figure as a function of frequency**

11.1 Application PCB

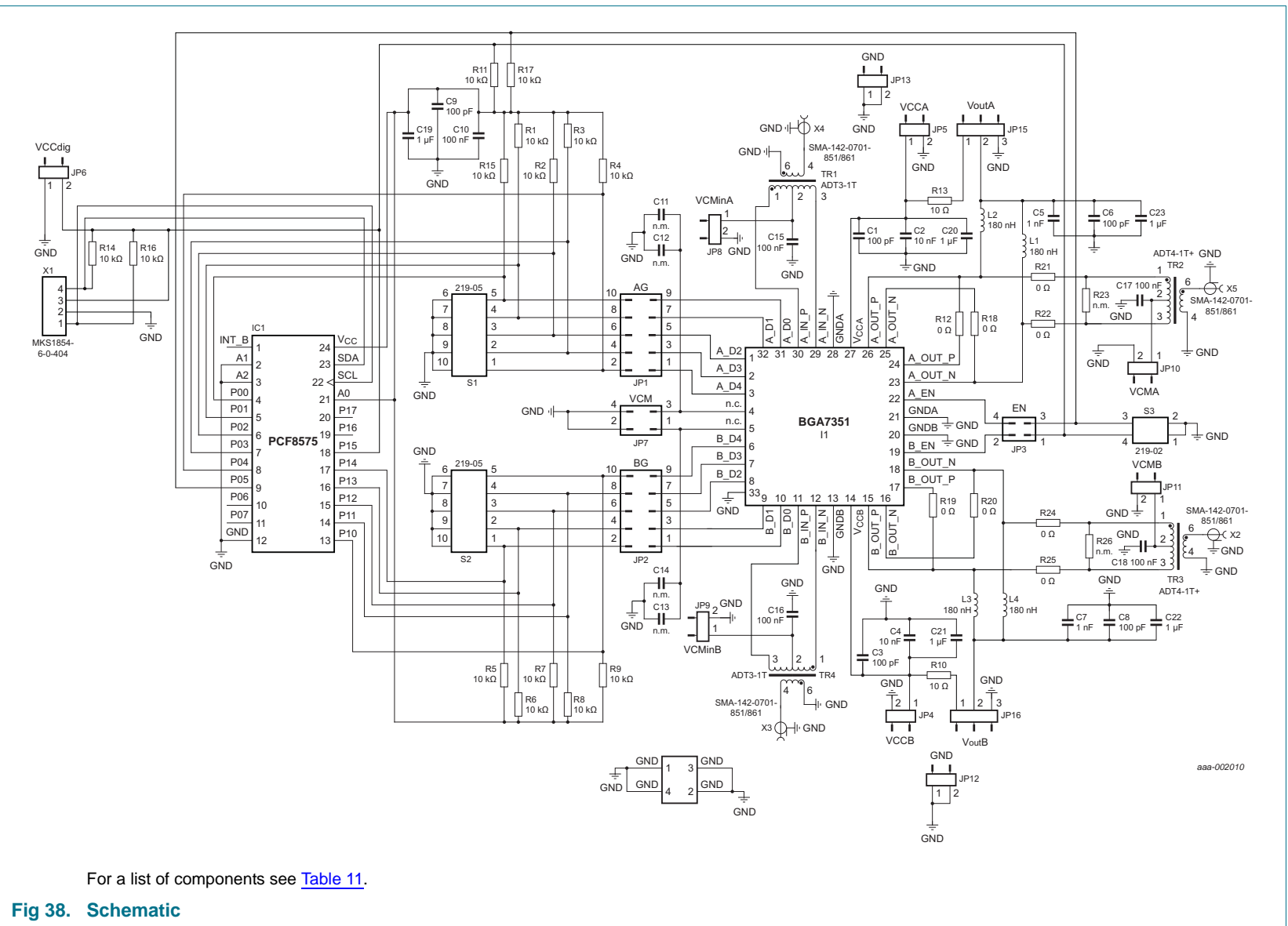

For a list of components see [Table 11](#).

Fig 38. Schematic

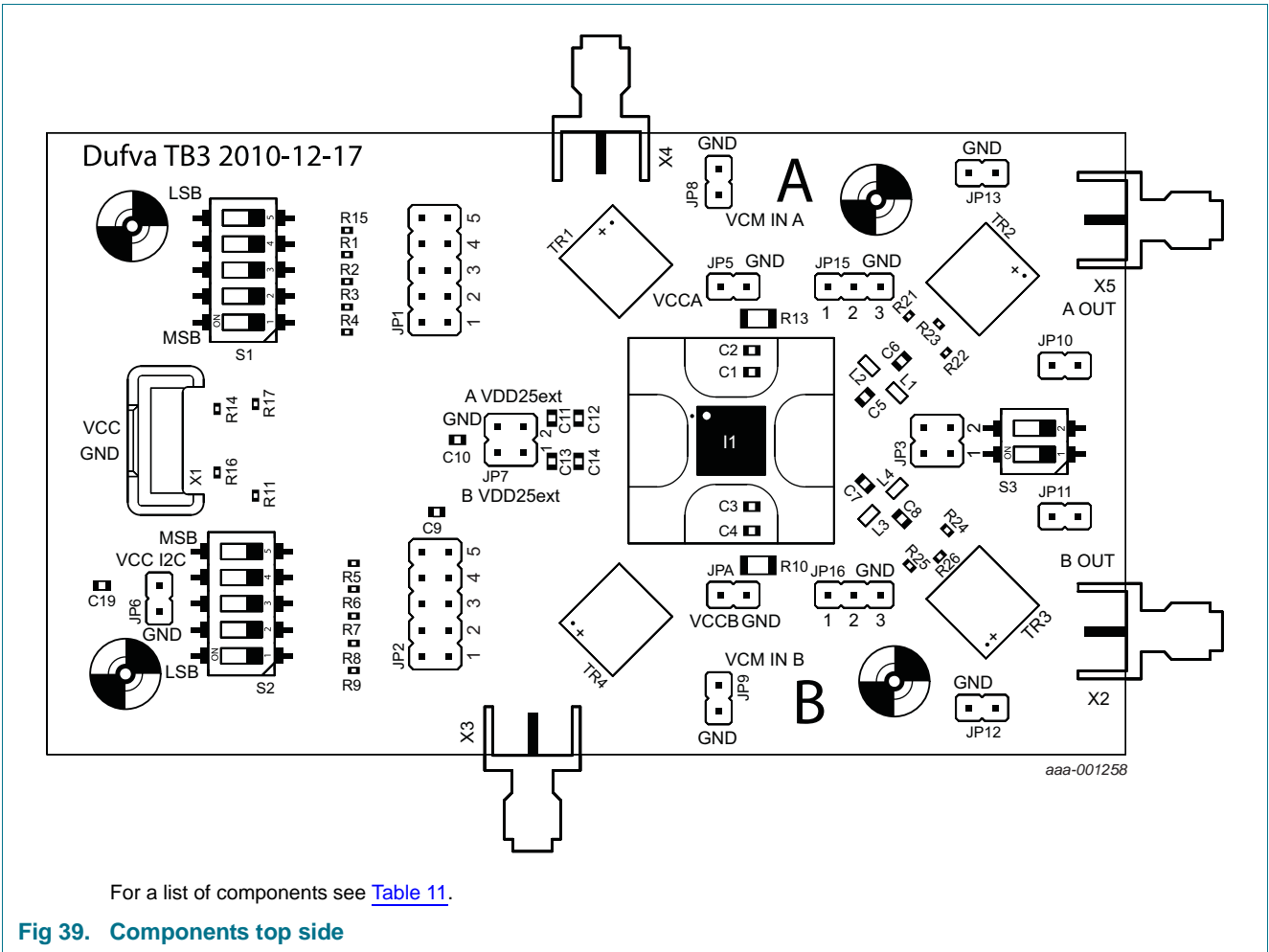

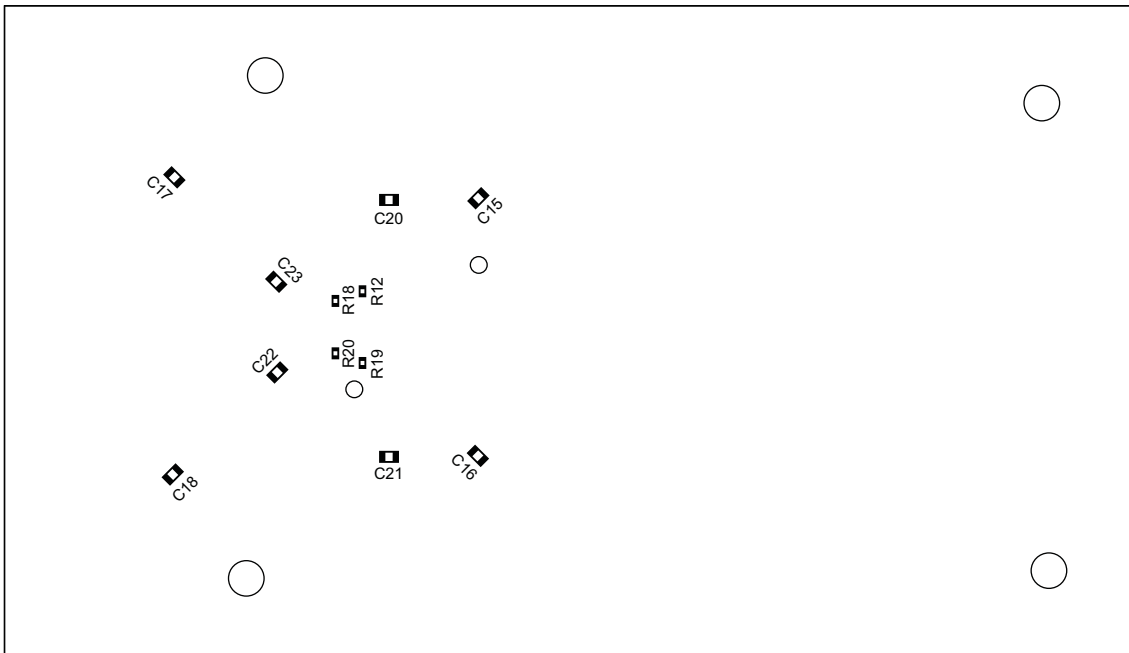

aaa-001259

For a list of components see [Table 11](#).

**Fig 40. Components bottom side**

**Table 11. List of components**

See [Figure 38](#), [Figure 39](#) and [Figure 40](#).

Component	Description	Conditions	Value	Size	Remarks
C1, C3, C6, C8, C9	capacitor		100 pF	0603	
C2, C4	capacitor		10 nF	0603	
C5, C7	capacitor		1 nF	0603	
C10, C15, C16, C17, C18	capacitor		100 nF	0603	
C11	capacitor		-	0603	not mounted
C12	capacitor		-	0603	not mounted
C13	capacitor		-	0603	not mounted
C14	capacitor		-	0603	not mounted
C19, C20, C21, C22, C23	capacitor		1 $\mu$ F	0603	
I1	BGA7351		-		
JP1	jumper		-	JP5	AG
JP2	jumper		-	JP5	BG
JP3	jumper		-	JP2	EN
JP4	jumper		-	JP2	VCCB
JP5	jumper		-	JP2	VCCA
JP6	jumper		-	JP2	VCCdig
JP7	jumper		-	JP2	VCM
JP8	jumper		-	JP2	VCMInA

**Table 11. List of components**  
See [Figure 38](#), [Figure 39](#) and [Figure 40](#).

Component	Description	Conditions	Value	Size	Remarks
JP9	jumper		-	JP2	VCMInB
JP10	jumper		-	JP2	VCMA
JP11	jumper		-	JP2	VCMB
JP12	jumper		-	JP2	GND
JP13	jumper		-	JP2	GND
JP15	jumper		-	JP3	VoutA
JP16	jumper		-	JP3	VoutB
L1, L2, L3, L4	inductor	$f_{IF} = 50 \text{ MHz}$	1200 nH	0603	dependent on PCB layout
		$f_{IF} = 172 \text{ MHz}$	150 nH	0603	dependent on PCB layout
		$f_{IF} = 250 \text{ MHz}$	56 nH	0603	dependent on PCB layout
		$f_{IF} = 450 \text{ MHz}$	27 nH	0603	dependent on PCB layout
R1, R2, R3, R4, R5, R6, R7, R8, R9, R11, R14, R15, R16, R17	resistor		10 k $\Omega$	0402	
R10, R13	resistor		10 $\Omega$	1206	
R12, R18, R19, R20, R21, R22, R24, R25	resistor		0 $\Omega$	0402	
R23, R26	resistor		-	0402	not mounted
S1, S2	DIP-switch		-		CTS-219-05
S3	DIP-switch		-		CTS-219-02
TR1	1:3 transformer		-		Mini Circuits ADT3-1T+
TR2	1:4 transformer		-		Mini Circuits ADT4-1T+
TR3	1:3 transformer		-		Mini Circuits ADT4-1T+
TR4	1:4 transformer		-		Mini Circuits ADT3-1T+
X1	-		-		not mounted
X2	SMA-connector		-		BOUT_P
X3	SMA-connector		-		BIN_P
X4	SMA-connector		-		AIN_P
X5	SMA-connector		-		AOUT_P

12. Package outline

HVQFN32: plastic thermal enhanced very thin quad flat package; no leads; 32 terminals; body 5 x 5 x 0.85 mm

SOT617-1

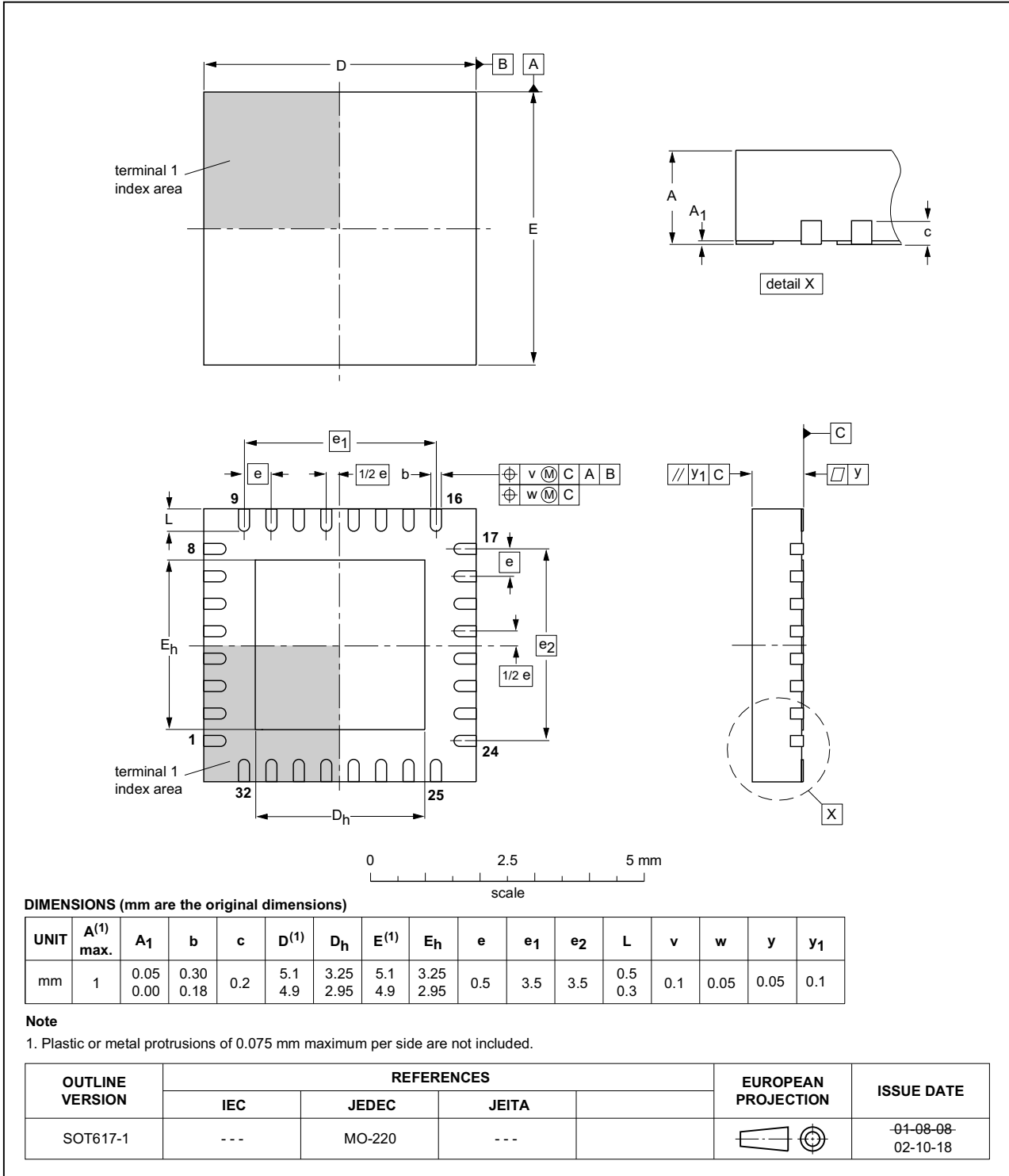

Fig 41. Package outline SOT617-1 (HVQFN32)



## 13. Abbreviations

Table 12. Abbreviations

Acronym	Description
ADC	Analog-to-Digital Converter
DIP	Dual In-line Package
EMI	ElectroMagnetic Interference
ESD	ElectroStatic Discharge
GSM	Global System for Mobile Communications
HTOL	High Temperature Operating Life
HVQFN	Heatsink Very-thin Quad Flat-pack No-leads
IF	Intermediate Frequency
LSB	Least Significant Bit
LTE	Long Term Evolution
MMIC	Monolithic Microwave Integrated Circuit
MSB	Most Significant Bit
PCB	Printed-Circuit Board
SMA	SubMiniature version A
WiMAX	Worldwide Interoperability for Microwave Access
W-CDMA	Wideband Code Division Multiple Access

## 14. Revision history

Table 13. Revision history

Document ID	Release date	Data sheet status	Change notice	Supersedes
BGA7351 v.3	20140611	Product data sheet	-	BGA7351 v.2
Modifications:	<ul style="list-style-type: none"> <li>• <a href="#">Table 8 on page 7</a>: some changes have been made</li> <li>• <a href="#">Section 11 on page 11</a>: some graphs have been added.</li> <li>• <a href="#">Table 11 on page 22</a>: the condition <math>f = 450</math> MHz has been added for the row containing the inductors</li> </ul>			
BGA7351 v.2	20121219	Product data sheet	-	BGA7351 v.1
BGA7351 v.1	20111228	Product data sheet	-	-

## 15. Legal information

### 15.1 Data sheet status

Document status <sup>[1][2]</sup>	Product status <sup>[3]</sup>	Definition
Objective [short] data sheet	Development	This document contains data from the objective specification for product development.
Preliminary [short] data sheet	Qualification	This document contains data from the preliminary specification.
Product [short] data sheet	Production	This document contains the product specification.

[1] Please consult the most recently issued document before initiating or completing a design.

[2] The term 'short data sheet' is explained in section "Definitions".

[3] The product status of device(s) described in this document may have changed since this document was published and may differ in case of multiple devices. The latest product status information is available on the Internet at URL <http://www.nxp.com>.

### 15.2 Definitions

**Draft** — The document is a draft version only. The content is still under internal review and subject to formal approval, which may result in modifications or additions. NXP Semiconductors does not give any representations or warranties as to the accuracy or completeness of information included herein and shall have no liability for the consequences of use of such information.

**Short data sheet** — A short data sheet is an extract from a full data sheet with the same product type number(s) and title. A short data sheet is intended for quick reference only and should not be relied upon to contain detailed and full information. For detailed and full information see the relevant full data sheet, which is available on request via the local NXP Semiconductors sales office. In case of any inconsistency or conflict with the short data sheet, the full data sheet shall prevail.

**Product specification** — The information and data provided in a Product data sheet shall define the specification of the product as agreed between NXP Semiconductors and its customer, unless NXP Semiconductors and customer have explicitly agreed otherwise in writing. In no event however, shall an agreement be valid in which the NXP Semiconductors product is deemed to offer functions and qualities beyond those described in the Product data sheet.

### 15.3 Disclaimers

**Limited warranty and liability** — Information in this document is believed to be accurate and reliable. However, NXP Semiconductors does not give any representations or warranties, expressed or implied, as to the accuracy or completeness of such information and shall have no liability for the consequences of use of such information. NXP Semiconductors takes no responsibility for the content in this document if provided by an information source outside of NXP Semiconductors.

In no event shall NXP Semiconductors be liable for any indirect, incidental, punitive, special or consequential damages (including - without limitation - lost profits, lost savings, business interruption, costs related to the removal or replacement of any products or rework charges) whether or not such damages are based on tort (including negligence), warranty, breach of contract or any other legal theory.

Notwithstanding any damages that customer might incur for any reason whatsoever, NXP Semiconductors' aggregate and cumulative liability towards customer for the products described herein shall be limited in accordance with the *Terms and conditions of commercial sale* of NXP Semiconductors.

**Right to make changes** — NXP Semiconductors reserves the right to make changes to information published in this document, including without limitation specifications and product descriptions, at any time and without notice. This document supersedes and replaces all information supplied prior to the publication hereof.

**Suitability for use** — NXP Semiconductors products are not designed, authorized or warranted to be suitable for use in life support, life-critical or safety-critical systems or equipment, nor in applications where failure or malfunction of an NXP Semiconductors product can reasonably be expected to result in personal injury, death or severe property or environmental damage. NXP Semiconductors and its suppliers accept no liability for inclusion and/or use of NXP Semiconductors products in such equipment or applications and therefore such inclusion and/or use is at the customer's own risk.

**Applications** — Applications that are described herein for any of these products are for illustrative purposes only. NXP Semiconductors makes no representation or warranty that such applications will be suitable for the specified use without further testing or modification.

Customers are responsible for the design and operation of their applications and products using NXP Semiconductors products, and NXP Semiconductors accepts no liability for any assistance with applications or customer product design. It is customer's sole responsibility to determine whether the NXP Semiconductors product is suitable and fit for the customer's applications and products planned, as well as for the planned application and use of customer's third party customer(s). Customers should provide appropriate design and operating safeguards to minimize the risks associated with their applications and products.

NXP Semiconductors does not accept any liability related to any default, damage, costs or problem which is based on any weakness or default in the customer's applications or products, or the application or use by customer's third party customer(s). Customer is responsible for doing all necessary testing for the customer's applications and products using NXP Semiconductors products in order to avoid a default of the applications and the products or of the application or use by customer's third party customer(s). NXP does not accept any liability in this respect.

**Limiting values** — Stress above one or more limiting values (as defined in the Absolute Maximum Ratings System of IEC 60134) will cause permanent damage to the device. Limiting values are stress ratings only and (proper) operation of the device at these or any other conditions above those given in the Recommended operating conditions section (if present) or the Characteristics sections of this document is not warranted. Constant or repeated exposure to limiting values will permanently and irreversibly affect the quality and reliability of the device.

**Terms and conditions of commercial sale** — NXP Semiconductors products are sold subject to the general terms and conditions of commercial sale, as published at <http://www.nxp.com/profile/terms>, unless otherwise agreed in a valid written individual agreement. In case an individual agreement is concluded only the terms and conditions of the respective agreement shall apply. NXP Semiconductors hereby expressly objects to applying the customer's general terms and conditions with regard to the purchase of NXP Semiconductors products by customer.

**No offer to sell or license** — Nothing in this document may be interpreted or construed as an offer to sell products that is open for acceptance or the grant, conveyance or implication of any license under any copyrights, patents or other industrial or intellectual property rights.

**Export control** — This document as well as the item(s) described herein may be subject to export control regulations. Export might require a prior authorization from competent authorities.

**Quick reference data** — The Quick reference data is an extract of the product data given in the Limiting values and Characteristics sections of this document, and as such is not complete, exhaustive or legally binding.

**Non-automotive qualified products** — Unless this data sheet expressly states that this specific NXP Semiconductors product is automotive qualified, the product is not suitable for automotive use. It is neither qualified nor tested in accordance with automotive testing or application requirements. NXP Semiconductors accepts no liability for inclusion and/or use of non-automotive qualified products in automotive equipment or applications.

In the event that customer uses the product for design-in and use in automotive applications to automotive specifications and standards, customer (a) shall use the product without NXP Semiconductors' warranty of the

product for such automotive applications, use and specifications, and (b) whenever customer uses the product for automotive applications beyond NXP Semiconductors' specifications such use shall be solely at customer's own risk, and (c) customer fully indemnifies NXP Semiconductors for any liability, damages or failed product claims resulting from customer design and use of the product for automotive applications beyond NXP Semiconductors' standard warranty and NXP Semiconductors' product specifications.

**Translations** — A non-English (translated) version of a document is for reference only. The English version shall prevail in case of any discrepancy between the translated and English versions.

## 15.4 Trademarks

Notice: All referenced brands, product names, service names and trademarks are the property of their respective owners.

## 16. Contact information

For more information, please visit: <http://www.nxp.com>

For sales office addresses, please send an email to: [salesaddresses@nxp.com](mailto:salesaddresses@nxp.com)

## 17. Contents

<b>1</b>	<b>Product profile</b> . . . . .	<b>1</b>
1.1	General description . . . . .	1
1.2	Features and benefits . . . . .	1
1.3	Applications . . . . .	2
1.4	Quick reference data . . . . .	2
<b>2</b>	<b>Pinning information</b> . . . . .	<b>3</b>
2.1	Pinning . . . . .	3
2.2	Pin description . . . . .	3
<b>3</b>	<b>Ordering information</b> . . . . .	<b>4</b>
<b>4</b>	<b>Functional diagram</b> . . . . .	<b>5</b>
<b>5</b>	<b>Enable control</b> . . . . .	<b>5</b>
<b>6</b>	<b>Limiting values</b> . . . . .	<b>6</b>
<b>7</b>	<b>Thermal characteristics</b> . . . . .	<b>6</b>
<b>8</b>	<b>Static characteristics</b> . . . . .	<b>7</b>
<b>9</b>	<b>Dynamic characteristics</b> . . . . .	<b>7</b>
<b>10</b>	<b>Moisture sensitivity</b> . . . . .	<b>10</b>
<b>11</b>	<b>Application information</b> . . . . .	<b>11</b>
11.1	Application PCB . . . . .	20
<b>12</b>	<b>Package outline</b> . . . . .	<b>24</b>
<b>13</b>	<b>Abbreviations</b> . . . . .	<b>25</b>
<b>14</b>	<b>Revision history</b> . . . . .	<b>25</b>
<b>15</b>	<b>Legal information</b> . . . . .	<b>26</b>
15.1	Data sheet status . . . . .	26
15.2	Definitions . . . . .	26
15.3	Disclaimers . . . . .	26
15.4	Trademarks . . . . .	27
<b>16</b>	<b>Contact information</b> . . . . .	<b>27</b>
<b>17</b>	<b>Contents</b> . . . . .	<b>28</b>

Please be aware that important notices concerning this document and the product(s) described herein, have been included in section 'Legal information'.

© NXP Semiconductors N.V. 2014.

All rights reserved.

For more information, please visit: <http://www.nxp.com>

For sales office addresses, please send an email to: [salesaddresses@nxp.com](mailto:salesaddresses@nxp.com)

Date of release: 11 June 2014

Document identifier: BGA7351