

### Device Features

- OIP3 = 41.0 dBm @ 70 MHz
- Gain = 22.0 dB @ 70 MHz
- Output P1 dB = 21.0 dBm @ 70 MHz
- Patented temperature compensation
- RoHS2-compliant SOT-89 SMT package



### Product Description

BeRex's BG20B is a high performance InGaP/ GaAs HBT MMIC amplifier, internally matched to 50 Ohms and uses a patented **temperature compensation** circuit to provide stable current over the operating temperature range without the need for external components. The BG20B is designed for high linearity IF amplifier that requires excellent gain, high OIP3 and flatness. It is packaged in a RoHS2-compliant with SOT-89 surface mount package.

### Applications

- Base station Infrastructure/RFID
- Commercial/Industrial/Military wireless system

### Applications Circuit

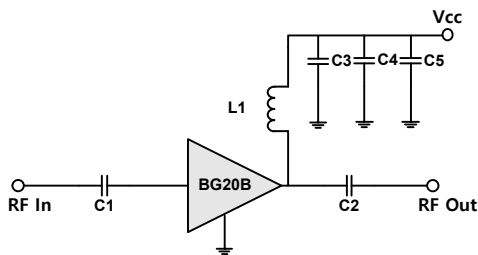

\*C1, C2=2700pF ± 5%; C3 = 100 pF ± 5%; C4 = 1000pF ±5%

\*C5 = 10uF; L1 = 470nH ±5%

### Electrical Specifications

Device performance \_ measured on a BeRex evaluation board at 25°C, Vc=5V, 50 Ω system.

Parameter	Conditions	Min	Typ	Max	Unit
Operational Frequency Range		5		800	MHz
Test Frequency			70		MHz
Gain		20.5	22.0		dB
Input Return Loss			-23.5		dB
Output Return Loss			-18.0		dB
Output IP3	13 dBm / tone , Δf=1 MHz	38.0	41.0		dBm
Output P1dB		20.0	21.0		dBm
Noise Figure			4.6		dB

### Recommended Operating Conditions

Parameter	Min	Typ	Max	Unit
Bandwidth	5		800	MHz
I <sub>c</sub> @ (V <sub>c</sub> = 5V)	84	105	126	mA
V <sub>c</sub>	3.5	5.0	5.25	V
dG/dT		-0.002		dB/°C
R <sub>TH</sub>		50		°C/W
Operating Case Temperature	-40		+85	°C

Electrical specifications are measured at specified test conditions.

Specifications are not guaranteed over all recommended operating conditions.

### Absolute Maximum Ratings

Parameter	Rating	Unit
Storage Temperature	-55 to +155	°C
Junction Temperature	+180	°C
Supply Voltage	+6.0	V
Supply Current	200	mA
Input RF Power	23	dBm

Operation of this device above any of these parameters may result in permanent damage.

## 5-800 MHz Internally Matched IF Amplifier

Typical Performance ( $V_c = 5V$ ,  $V_{device} = 4.85V$ ,  $I_c = 99mA$ ,  $T = 25^\circ C$ )

Freq	MHz	70	140	250	500	800
S21	dB	22.0	21.9	21.7	21.0	20.5
S11	dB	-23.5	-26.5	-27.0	-25.5	-23.2
S22	dB	-18.0	-21.5	-20.0	-16.0	-12.2
P1	dBm	21.0	21.0	21.0	21.0	19.0
OIP3	dBm	41.0	39.5	38.5	36.0	31.0
NF	dB	4.6	4.7	4.7	4.8	4.8

\*4.85V at the device is due to 0.15V drop across 470nH choke inductor.

Typical Performance ( $V_d = 4.7V$ ,  $I_c = 92mA$ ,  $T = 25^\circ C$ )

Freq	MHz	70	140	250	500	800
S21	dB	21.8	21.7	21.6	21.2	20.5
S11	dB	-23.4	-30.3	-33.7	-28.4	-23.2
S22	dB	-16.1	-16.1	-16.8	-16.5	-12.0
P1	dBm	20.0	20.6	20.7	20.1	18.7
OIP3	dBm	40.0	39.0	37.0	33.5	30.0
NF	dB	4.6	4.7	4.7	4.8	4.8

Typical Performance ( $V_d = 4.5V$ ,  $I_c = 79mA$ ,  $T = 25^\circ C$ )

Freq	MHz	70	140	250	500	800
S21	dB	21.8	21.8	21.6	20.9	20.4
S11	dB	-23.8	-30.5	-34.3	-29.0	-23.2
S22	dB	-15.8	-15.8	-16.5	-16.2	-11.8
P1	dBm	19.8	19.3	19.2	19.6	17.9
OIP3	dBm	34.0	37.0	35.5	35.5	29.5
NF	dB	4.6	4.7	4.7	4.8	4.8

Typical Performance ( $V_d = 4V$ ,  $I_c = 51mA$ ,  $T = 25^\circ C$ )

Freq	MHz	70	140	250	500	800
S21	dB	21.4	21.3	21.2	20.9	20.1
S11	dB	-26.1	-28.1	-29.3	-28.5	-22.3
S22	dB	-15.0	-14.6	-15.1	-15.1	-11.2
P1	dBm	17.3	17.4	17.4	17.1	15.8
OIP3	dBm	31.0	32.0	31.0	29.0	27.5
NF	dB	4.6	4.7	4.7	4.8	4.8

Typical Performance ( $V_d = 3.5V$ ,  $I_c = 26mA$ ,  $T = 25^\circ C$ )

Freq	MHz	70	140	250	500	800
S21	dB	20.3	20.2	20.1	19.8	19.1
S11	dB	-21.8	-19.4	-19.3	-20.3	-18.3
S22	dB	-12.1	-11.5	-12.0	-12.4	-9.9
P1	dBm	11.8	11.7	12.0	11.1	11.0
OIP3	dBm	22.5	23.5	22.5	22.0	22.5
NF	dB	4.6	4.7	4.7	4.8	4.8

### Typical Device Data

S-parameters (Vc=5V, Ic=105mA, T=25°C)

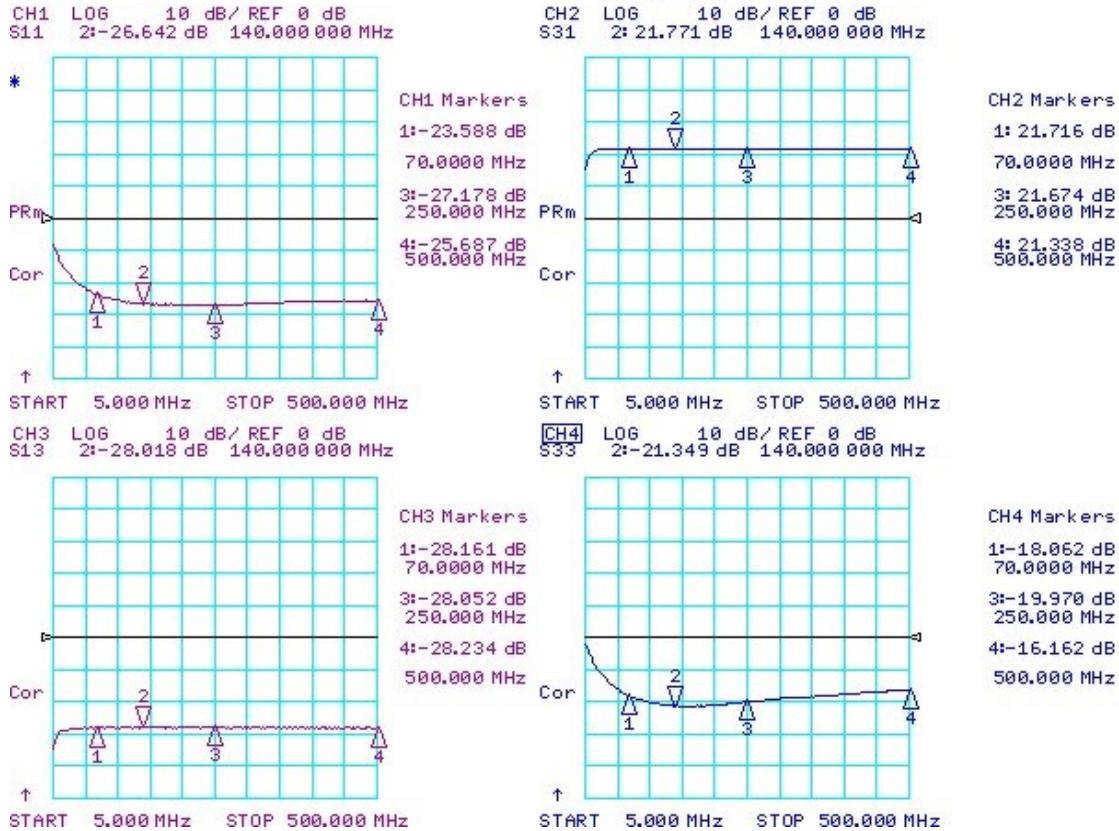

### S-Parameter

(Vdevice = 5.0V, Icc = 105mA, T = 25 °C, calibrated to device leads)

Freq [MHz]	S11 [Mag]	S11 [Ang]	S21 [Mag]	S21 [Ang]	S12 [Mag]	S12 [Ang]	S22 [Mag]	S22 [Ang]
10	0.293	-57.621	9.026	-133.913	0.029	46.255	0.616	141.423
50	0.088	-114.698	12.090	-176.377	0.039	6.825	0.172	71.829
100	0.054	-148.463	12.277	170.024	0.040	-3.437	0.101	31.482
150	0.046	-176.865	12.246	160.120	0.040	-10.235	0.086	-2.318
200	0.045	162.862	12.226	151.169	0.039	-15.933	0.089	-28.165
250	0.044	146.555	12.127	142.934	0.040	-21.800	0.100	-46.876
300	0.046	131.631	12.088	134.539	0.039	-26.571	0.111	-59.613
350	0.049	120.839	11.925	126.455	0.039	-31.386	0.122	-69.609
400	0.050	113.381	11.924	118.460	0.039	-36.144	0.132	-79.222
450	0.052	104.506	11.695	110.451	0.039	-41.080	0.144	-87.009
500	0.052	93.956	11.668	103.010	0.039	-45.503	0.157	-93.192

### V-I Characteristics

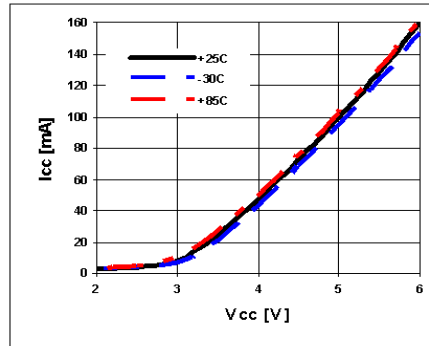

### BeRex SOT89 Evaluation Board

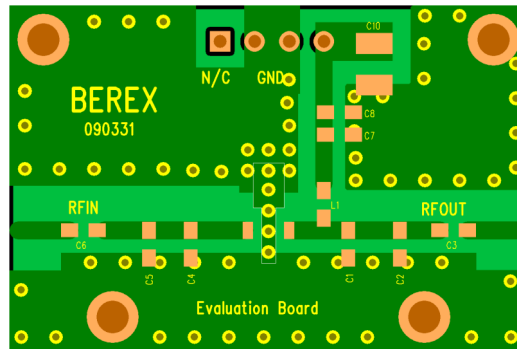

\*Dielectric constant\_ 4.2 \*RF pattern width 52mil \*31mil thick FR4 PCB

### Typical Performance (Vc=5V, Ic=105mA, T=25°C)

#### Pin-Pout-Gain

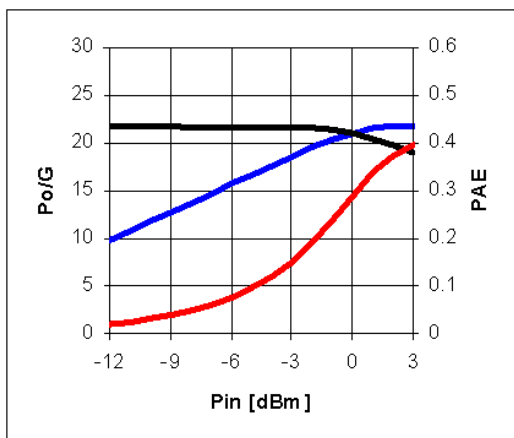

**200MHz**

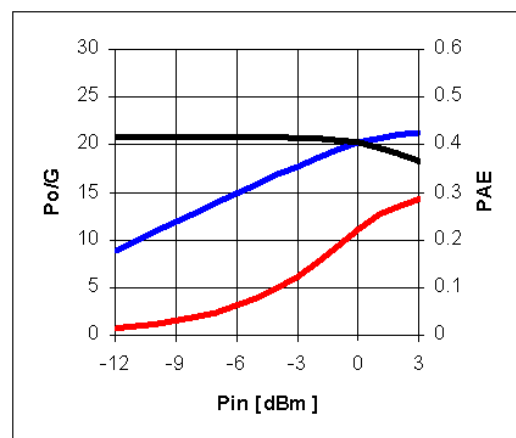

**500 MHz**

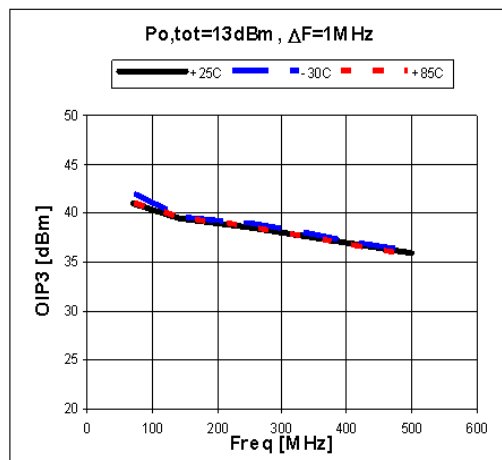
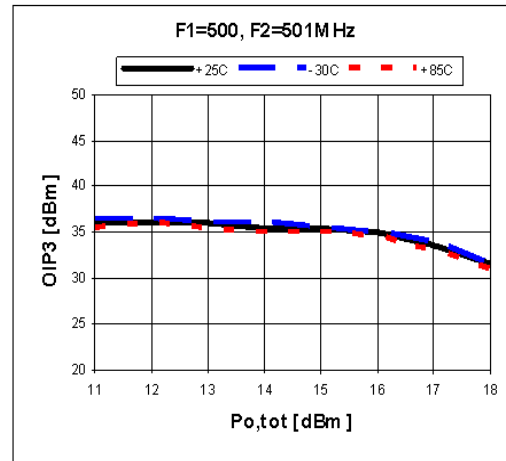
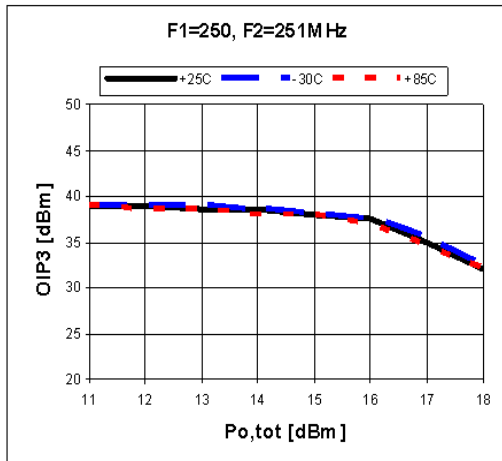
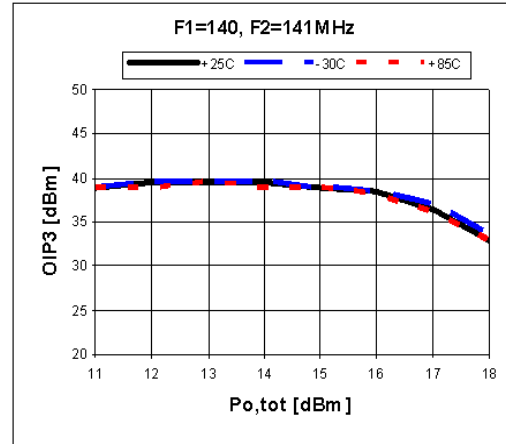
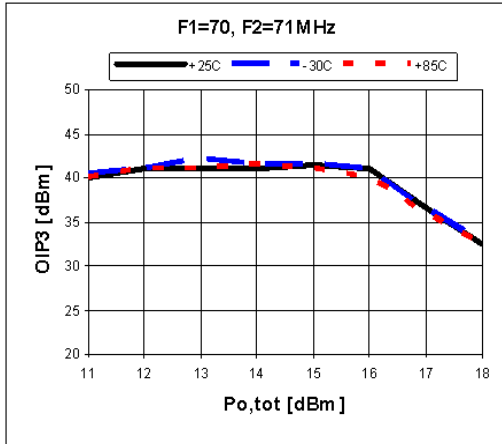
**OIP3**

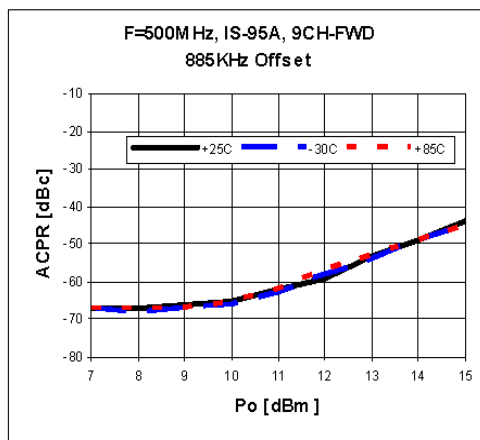
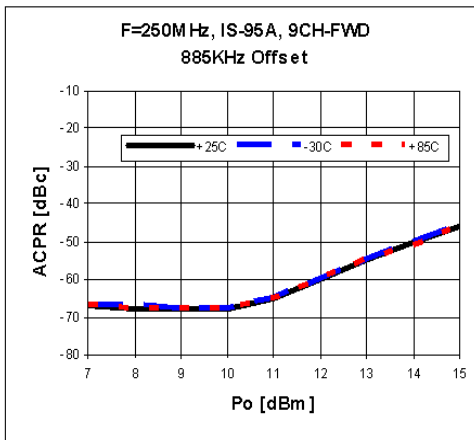
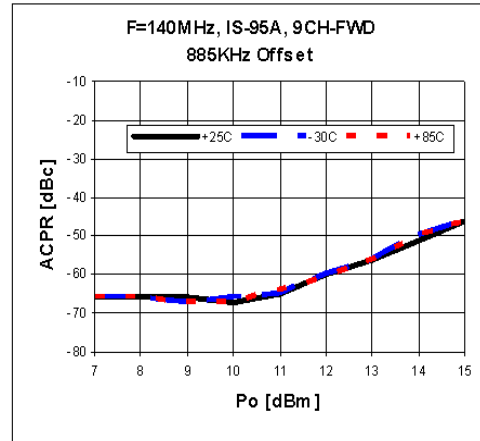
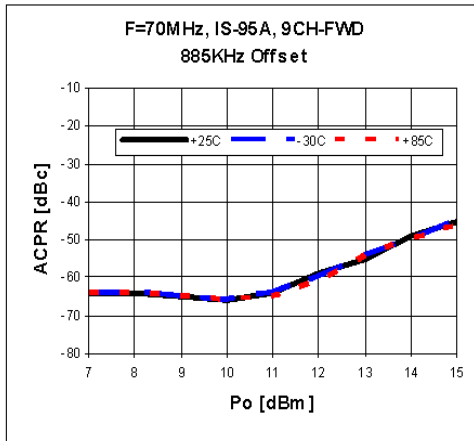
**ACPR**

### ACLR

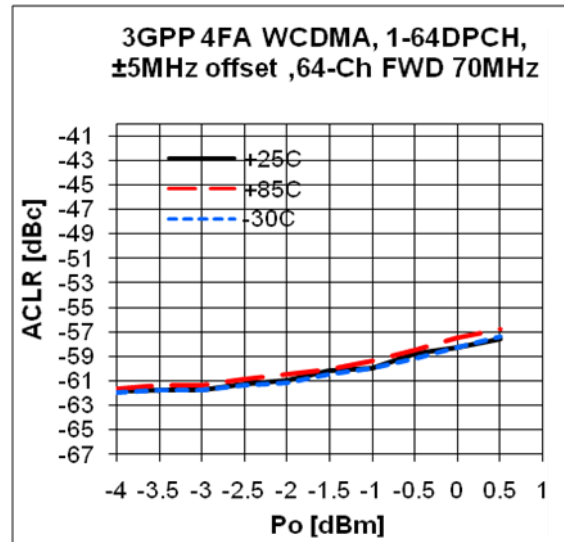

### Gain Flatness

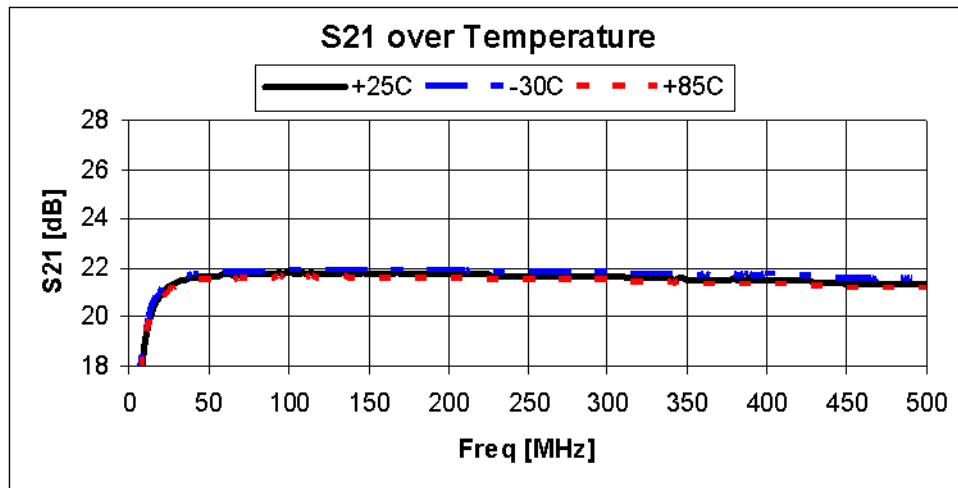

### Package Outline Dimension

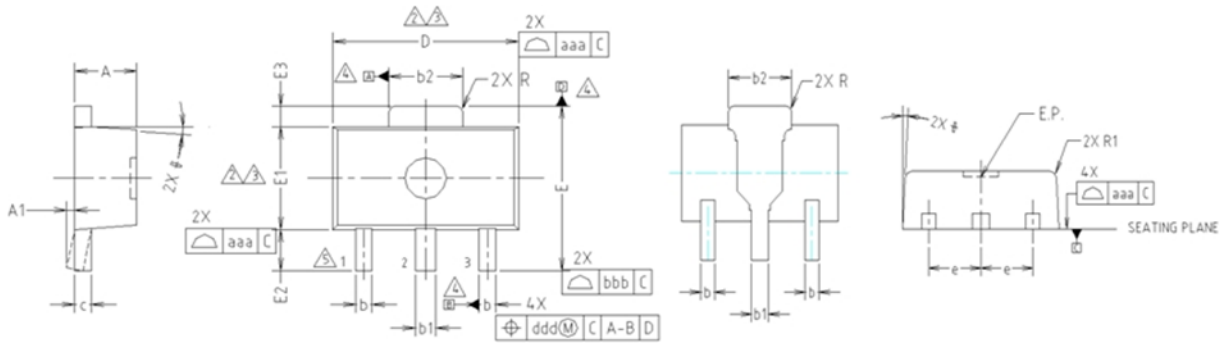

- NOTE:**  
 1. DIMENSIONS IN MILLIMETERS.
- ⚠ DIMENSION D DOES NOT INCLUDE MOLD FLASH, PROTRUSIONS OR GATE BURRS. MOLD FLASH, PROTRUSIONS OR GATE BURRS SHALL NOT EXCEED 0.5mm PER END. DIMENSION E1 DOES NOT INCLUDE INTERLEAD FLASH OR PROTRUSION. INTERLEAD FLASH OR PROTRUSION SHALL NOT EXCEED 0.5mm PER SIDE.
  - ⚠ DIMENSIONS D AND E1 ARE DETERMINED AT THE OUTMOST EXTREMES OF THE PLASTIC BODY EXCLUSIVE OF MOLD FLASH, TIE BAR BURRS, GATE BURRS AND INTERLEAD FLASH, BUT INCLUDING ANY MISMATCH BETWEEN THE TOP AND BOTTOM OF THE PLASTIC BODY.
  - ⚠ DATUMS A, B AND D TO BE DETERMINED 0.18mm FROM THE LEAD TIP.
  - ⚠ TERMINAL NUMBERS ARE SHOWN FOR REFERENCE ONLY.

SYMBOL	MILLIMETERS			NOTE
	MINIMUM	NOMINAL	MAXIMUM	
A	1.40	1.50	1.60	
A1	0.00	—	0.10	
b	0.38	0.42	0.48	
b1	0.48	0.52	0.58	
b2	1.79	1.82	1.87	
c	0.40	0.42	0.46	
D	4.40	4.50	4.70	2,3
E	3.70	4.00	4.30	
E1	2.40	2.50	2.70	2,3
E2	0.80	1.00	1.20	
E3	0.40	0.50	0.60	
e	1.50 TYP.			
φ	4° TYP.			
R	0.15 TYP.			
R1	—	—	0.20	
SYMBOL	TOLERANCES OF FORM AND POSITION		NOTE	
aaa	0.15			
bbb	0.20			
ccc	0.10			
ddd	0.10			

### Suggested PCB Land Pattern and PAD Layout

**PCB Land Pattern**

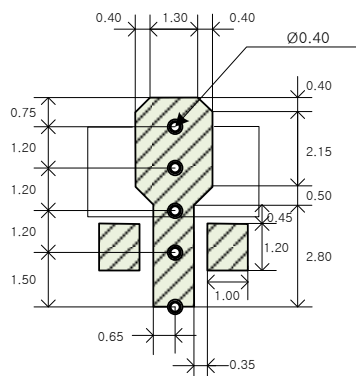

Note : All dimension \_ millimeters

PCB lay out \_ on BeRex website

**PCB Mounting**

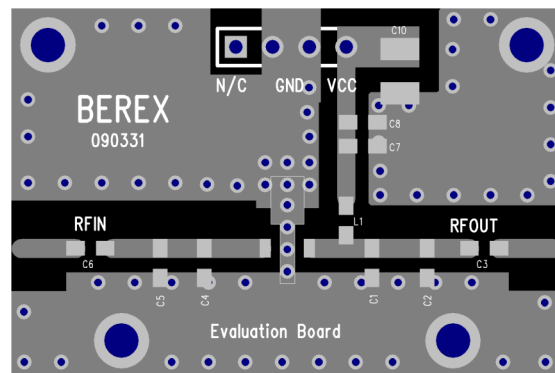



### Package Marking

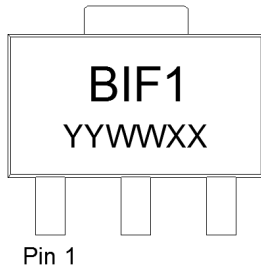

YY = Year, WW = Working Week,  
XX = Wafer No.

### Tape & Reel

SOT89

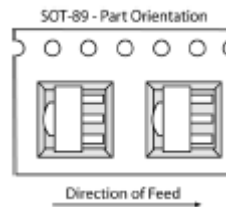

Packaging information:

Tape Width (mm): 12  
Reel Size (inches): 7  
Device Cavity Pitch (mm): 8  
Devices Per Reel: 1000

### Lead plating finish

100% Tin Matte finish

(All BeRex products undergoes a 1 hour, 150 degree C, Anneal bake to eliminate thin whisker growth concerns.)

### MSL / ESD Rating

<b>ESD Rating:</b>	Class 1C
<b>Value:</b>	<b>Passes &lt;2000V</b>
<b>Test:</b>	Human Body Model (HBM)
<b>Standard:</b>	JEDEC Standard JESD22-A114
<b>MSL Rating:</b>	<b>Level 1 at +260°C convection reflow</b>
<b>Standard:</b>	JEDEC Standard J-STD-020



Proper ESD procedures should be followed when handling this device.

**RoHS Compliance**

This part is compliant with Restrictions on the Use of Certain Hazardous Substances in Electrical and Electronic Equipment (RoHS) Directive 2011/65/EU as amended by Directive 2015/863/EU.

This product also is compliant with a concentration of the Substances of Very High Concern (SVHC) candidate list which are contained in a quantity of less than 0.1%(w/w) in each components of a product and/or its packaging placed on the European Community market by the BeRex and Suppliers.

**NATO CAGE code:**

2	N	9	6	F
---	---	---	---	---