



SPECIFICATION SHEET

SPECIFICATION SHEET NO.	N0310- SOD323V21WSST3
DATE	Mar. 10, 2021
REVISION	A0
DESCRIPTION	SMD Small Signal Fast Switching diodes, SOD-323 series, 2 pads Reverse Voltage 250V Max. Forward Current 250mA Max. Operating Temp. Range -55°C ~+150°C, Package in Tape/Reel, 3000pcs/Reel RoHS/RoHS III compliant
CUSTOMER	
CUSTOMER PART NUMBER	
CROSS REF. PART NUMBER	
ORIGINAL PART NUMBER	MDD BAV21WS
PART CODE	SOD323V21WSST3

VENDOR APPROVE			
Issued/Checked/Approved			
DATE: March 10, 2021			

CUSTOMER APPROVE	
DATE:	

SMD FAST SWITCHING DIODES SOD323 SERIES



MAIN FEATURE

- Fast switching speed
- Glass Passivated Chip Junction
- Fast reverse recovery time
- High conductance

APPLICATION

- For general purpose switching applications

RFQ

[Request For Quotation](#)

PART CODE GUIDE

SOD323	V21WS	S	T3
1	2	3	4

- 1) **SOD323**: SMD Small Signal Fast Switching diodes, 2 pads, SOD-323 series
- 2) **V21WS**: Type code for original part number BAV21WS
- 3) **S**: Package code, Tape/reel, 3000pcs/reel.
- 4) **T3**: Marking code for “T3” on the case surface, Different Marking for different specification.

MORE ITEMS AVAILABLE

SOD323V21WSST3				

SMD FAST SWITCHING DIODES SOD323 SERIES

DIMENSION (Unit: Inch/mm)

Image for reference



Marking: T3

SOD-323

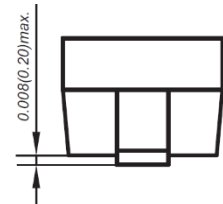
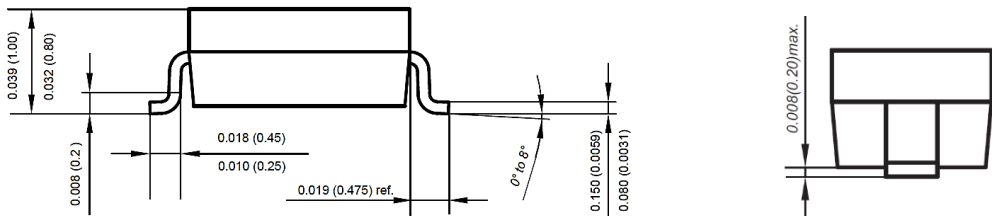
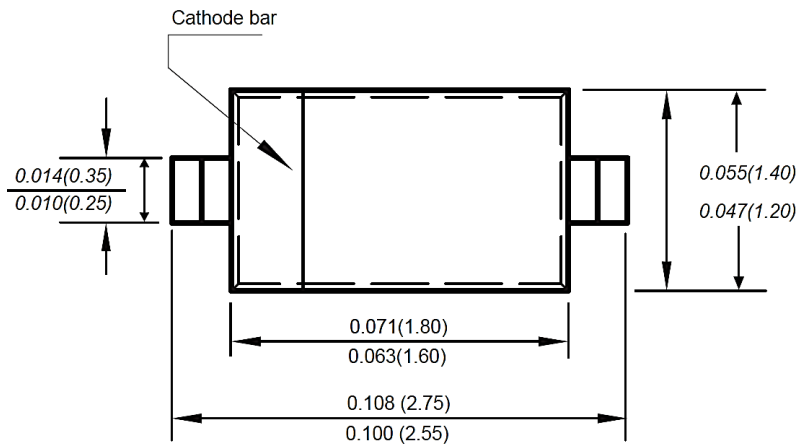

Recommend Pad Layout

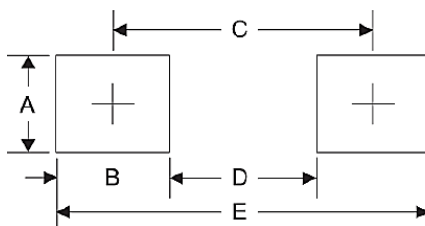

Symbol	Unit (inch)	Unit (mm)
A	0.028	0.70
B	0.028	0.70
C	0.085	2.15
D	0.071	1.80
E	0.112	2.85

SMD FAST SWITCHING DIODES SOD323 SERIES
MECHANICAL DATA

Case	Terminals	Polarity	Mounting Position	Weight per piece
JEDEC SOD-323 molded plastic body	Solder plated, Solderable per MIL-STD-750, Method 2026	Polarity symbol marking on case	Any	0.00019 Ounce, 0.00591 grams

ABSOLUTE MAX. RATING AT 25 °C

Parameter	SYMBOLS	VALUE			UNITS
		Min.	Typical	Max.	
Repetitive peak reverse voltage	V _{RRM}			250	Volts
RMS voltage	V _{RMS}			200	Volts
Continuous Forward Current	I _O			250	mA
Repetitive Peak Forward Current	I _{FM}			625	mA
Non-repetitive Peak forward surge current	@ = 1s	I _{FSM}		1	A
	@ = 1 ms			3	
	@ = 1 μs			9	
Total Power Dissipation	P _{tot}			500	mW
Operating Junction temperature range	T _J	-55		+150	°C
Storage temperature range	T _{STG}	-55		+150	°C

Characteristics at Ta= 25 °C

Parameter	SYMBOLS	VALUE			UNIT	Condition
		Min.	Typ.	Max.		
Reverse Current	I _R			0.1	μA	at V _R = 250 V, T _a = 25°C
				100		at V _R = 250 V, T _a = 150°C
Forward Voltage	V _F			1	V	I _F = 100 mA
				1.25		I = 200 mA
Capacitance between terminals	C _{tot}			5	pF	V _R =0V, f=1.0MHz
Reverse recovery time	t _{rr}			50	ns	I _F =0.5 A, I _R =1A I _{rr} =0.25A, R _L =100Ω

SMD FAST SWITCHING DIODES SOD323 SERIES
RELIABILITY

Number	Experiment Items	Experiment Method And Conditions	Reference Documents
1	Solder Resistance Test	Test 260°C± 5°C for 10 ± 2 sec. Immerse body into solder 1/16" ± 1/32"	MIL-STD-750D METHOD-2031.2
2	Solderability Test	230°C ±5°C for 5 sec.	MIL-STD-750D METHOD-2026.1 0
3	Pull Test	1 kg in axial lead direction for 10 sec.	MIL-STD-750D METHOD-2036.4
4	Bend Test	0.5Kg Weight Applied To Each Lead, Bending Arcs 90 °C ± 5 °C For 3 Times	MIL-STD-750D METHOD-2036.4
5	High Temperature Reverse Bias Test	TA=100°C for 1000 Hours at VR=80% Rated VR	MIL-STD-750D METHOD-1038.4
6	Forward Operation Life Test	TA=25°C Rated Average Rectified Current	MIL-STD-750D METHOD-1027.3
7	Intermittent Operation Life Test	On state: 5 min with rated IRMS Power Off state: 5 min with Cool Forced Air. On and off for 1000 cycles.	MIL-STD-750D METHOD-1036.3
8	Pressure Cooker Test	15 PSIG, TA=121°C, 4 hours	MIL-S-19500 APPENOIXC
9	Temperature Cycling Test	-55°C~+125°C; 30 Minutes For Dwelled Time 5 minutes for transferred time. Total: 10 cycles.	MIL-STD-750D METHOD-1051.7
10	Thermal Shock Test	0°C for 5 minutes., 100°C for 5minutes, Total: 10 cycles	MIL-STD-750D METHOD-1056.7
11	Forward Surge Test	8.3ms Single Sale Sine-wave One Surge.	MIL-STD-750D METHOD-4066.4
12	Humidity Test	TA=65°C, RH=98% for 1000 hours.	MIL-STD-750D METHOD-1021.3
13	High Temperature Storage life Test	150°C for 1000 Hours	MIL-STD-750D METHOD-1031.5

SMD FAST SWITCHING DIODES SOD323 SERIES

SUGGESTED REFLOW PROFILE (For Reference Only)

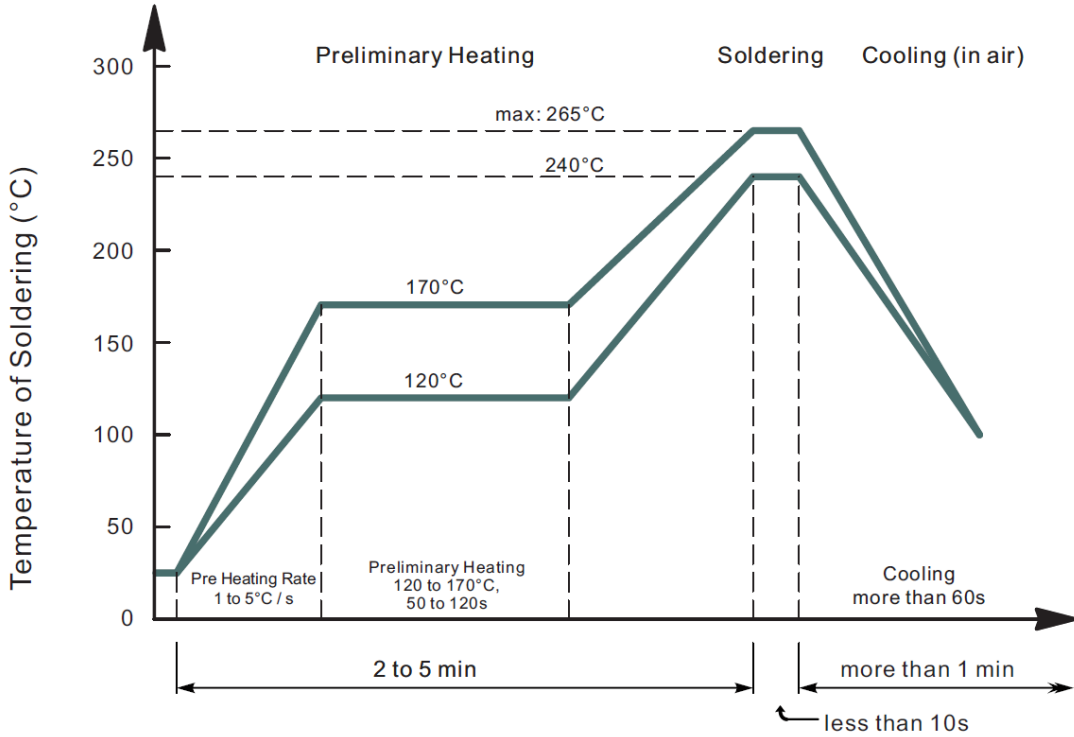

- Recommended peak temperature is over 245°C, If peak temperature is below 245 °C, you may adjust the following parameters; time length of peak temperature (longer), time length of soldering (longer), thickness of solder paste (thicker)
- Welding shall not exceed 2 times
- Remark: lead free solder paste (96.5 sn/3.0 Ag/0.5Cu)

SMD FAST SWITCHING DIODES SOD323 SERIES

RATINGS AND CHARACTERISTIC CURVES (For Reference Only)

Fig.1 Power Derating Curve

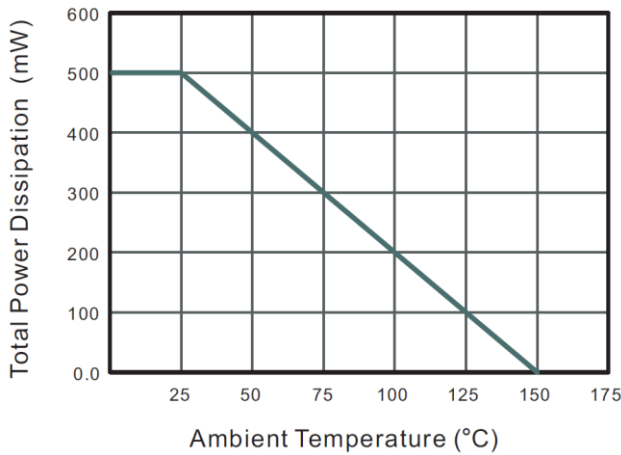

Fig.2 Typical Reverse Characteristics

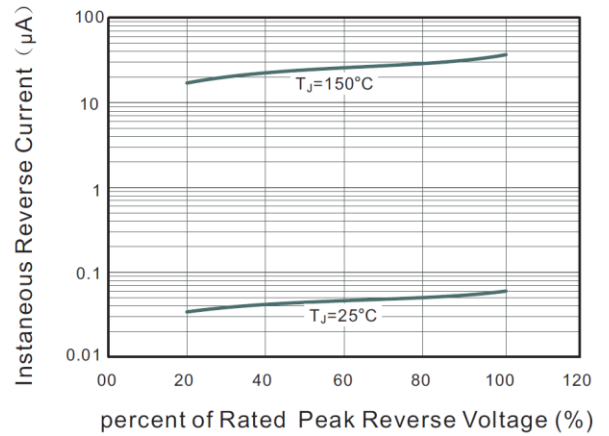

Fig.3 Typical Instantaneous Forward Characteristics

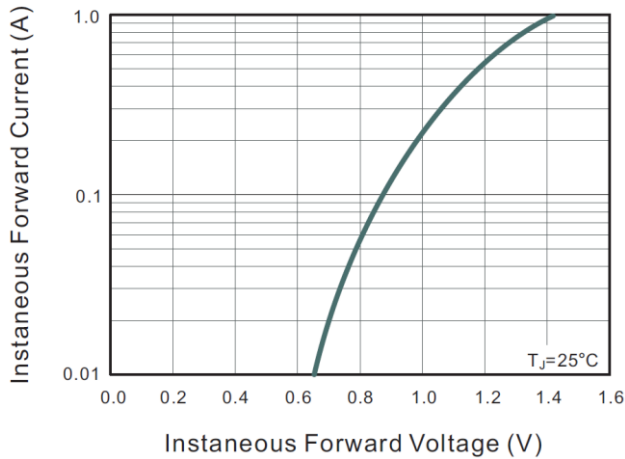
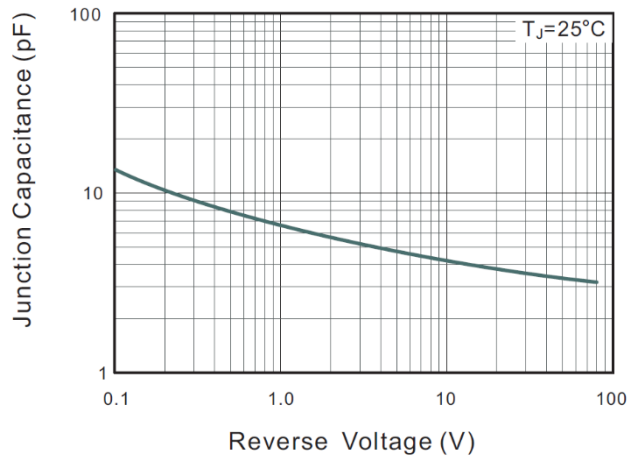
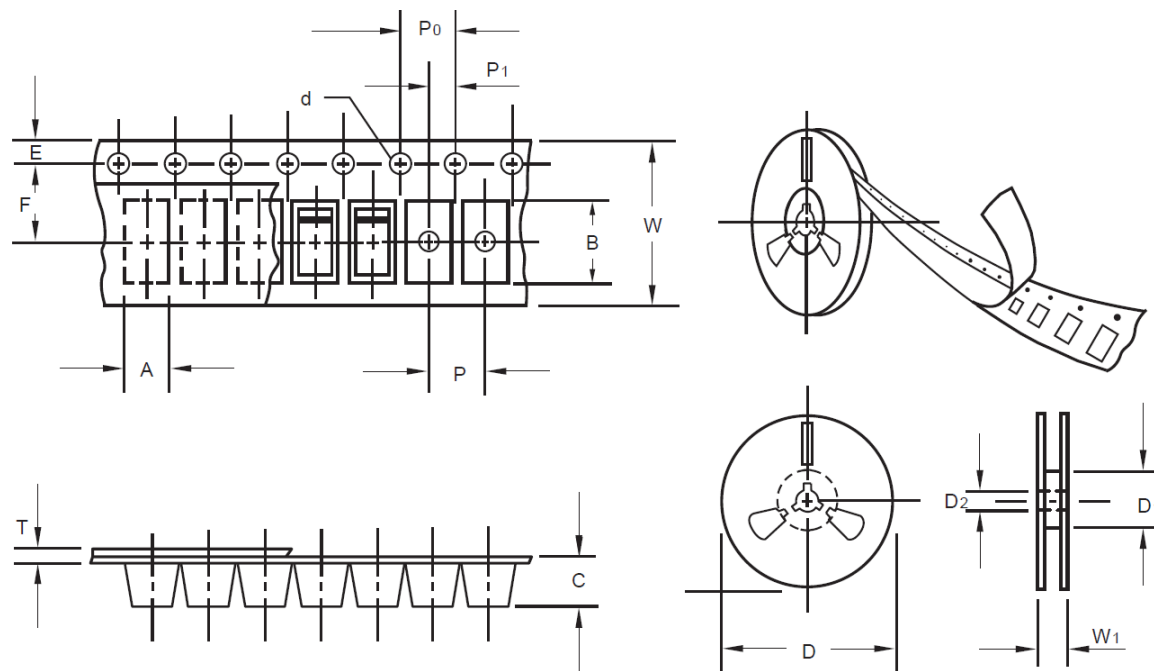

Fig.4 Typical Junction Capacitance



SMD FAST SWITCHING DIODES SOD323 SERIES
TAPE/REEL (Unit: mm)

All Devices are packed in accordance with EIA standard RS-481-A and specifications.



Item	Symbol	Tolerance	SO-323
Carrier width	A	0.1	2.10
Carrier Length	B	0.1	4.00
Carrier Depth	C	0.1	1.60
Sprocket hole	d	0.05	1.55
13" Reel outside diameter	-	-	-
13" Reel inner diameter	-	-	-
7" Reel outside diameter	D	2.0	178.00
7" Reel inner diameter	D1	Min.	50.00
Feed hole diameter	D2	0.5	13.00
Sprocket hole position	E	0.1	1.75
Punch hole position	F	0.1	3.50
Punch hole pitch	P	0.1	4.00
Sprocket hole pitch	P0	0.1	4.00
Embossment center	P1	0.1	2.00
Overall tape thickness	T	0.1	0.25
Tape width	W	0.3	8.15
Reel width	W1	1.0	10.50

SMD FAST SWITCHING DIODES SOD323 SERIES

PACKAGE

Case Code	Reel Size	MPQ (pcs)	Component Spacing (mm)	Qty. Per Box (pcs)	Inner Box L*W*H (mm)	Reel Size (mm)	Carton size L*W*H (mm)	Qty. Per Carton (pcs)	G. W (kg)
SOD-323	7"	3,000	-	24,000	210*208*203	178	400*400*250	180,000	8.0

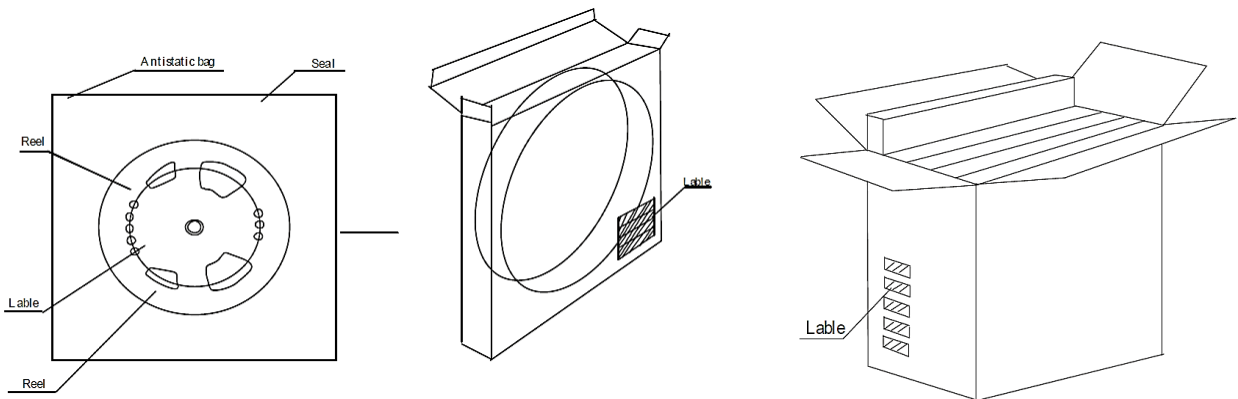

DISCLAIMER

NextGen Component, Inc. reserves the right to make changes to the product(s) and or information contained herein without notice. No liability is assumed as a result of their use or application. No rights under any patent accompany the sale of any such product(s) or information