

B39D3RGB-F6C0001HOU1930

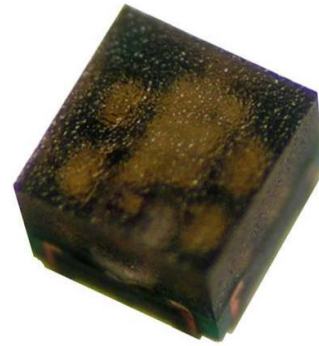

Features(產品特色)

- Package: RGB 3 in 1 package/4pin Polarity
(封裝方式：RGB三色封裝/4極性點)
- Anti-Reflection resin
啞光膠體
- View angle : $\geq 120^\circ$ (min 50% brightness)
發光角度：大於等於120度〔50%光強度〕
- Component solder able surface finish is gold
元件可銲接表面為鍍金板
- High contrast
高對比性

Main Applications(主要應用)

- Indoor display (室內顯示幕)
- Full color display(全彩顯示幕)
- Fine pitch application(細間距應用)

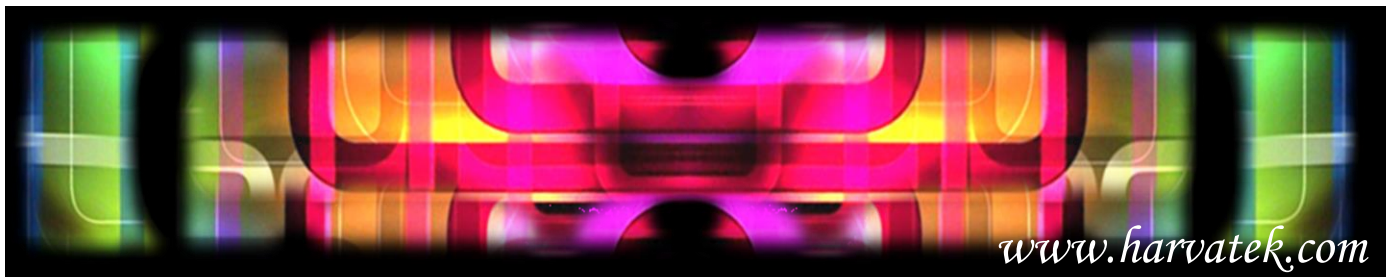

DISCLAIMER 免責聲明	3
PRODUCT SPECIFICATIONS 產品規格	4
ATTENTION: ELECTROSTATIC DISCHARGE (ESD) PROTECTION 靜電放電保護	5
LABEL SPECIFICATIONS 標籤規格	6
SPECIFICATIONS RANGE 規格範圍	8
PRODUCT FEATURES 產品特色	9
ELECTRO-OPTICAL CHARACTERISTICS 光學特性.....	9
PACKAGE OUTLINE DIMENSION AND RECOMMENDED SOLDERING PATTERN FOR REFLOW SOLDERING 封裝外形尺寸與建議的焊盤尺寸.....	9
ABSOLUTE MAXIMUM RATINGS 絕對最大額定值	10
CHARACTERISTICS OF B39D3RGB-F6	11
PRECAUTION FOR USE 使用注意事項	13
PACKAGING 包裝.....	14
TAPE DIMENSION 捲帶尺寸.....	14
REEL DIMENSION 捲盤尺寸.....	15
PACKING 包裝方式	15
DRY PACK 乾燥包裝方法	16
BAKING 烘烤	16
PRECAUTIONS 注意事項.....	17
REFLOW SOLDERING 迴流焊.....	17
REWORKING 重工	18
CLEANING 清潔	18
REVISE HISTORY 修改記錄	19

Official Product	HT Part No. B39D3RGB-F6C0001HOU1930	Customer Part No.	Data Sheet No.
Tentative Product	*****	*****	
Specifications are subject to changes for improvement without advance notice. Proprietary data, drawings, company confidential all rights reserved.		01/09/2020	Version 1.0
			Page 2/19

DISCLAIMER(免責聲明)

HARVATEK reserves the right to make changes without further notice to any products herein to improve reliability, function or design. HARVATEK does not assume any liability arising out of the application or use of any product or circuit described herein; neither does it convey any license under its patent rights, nor the rights of others.

(宏齊不需任何通知並保留隨時更改任何產品的權利，包含提高可靠度、功能或設計。宏齊於此不需承擔任何在應用面或是任何產品或是設計電路上的責任，即便是表達任何專利權或是其他權責)

Life Support Policy

HARVATEK's products are not authorized for use as critical components in life support devices or systems without the express written approval of the President of HARVATEK or HARVATEK INTERNATIONAL. As used herein:

1. Life support devices or systems are devices or systems which, (a) are intended for surgical implant into the body, or (b) support or sustain life, and (c) whose failure to perform when properly used in accordance with instructions for use provided in the labeling, can be reasonably expected to result in a significant injury of the user.
2. A critical component in any component of a life support device or system whose failure to perform can be reasonably expected to cause the failure of the life support device or system, or to affect its safety or effectiveness.

Official Product	HT Part No. B39D3RGB-F6C0001HOU1930	Customer Part No.	Data Sheet No.
Tentative Product	*****	*****	
Specifications are subject to changes for improvement without advance notice. Proprietary data, drawings, company confidential all rights reserved.		01/09/2020	Version 1.0
			Page 3/19

Product Specifications(產品規格)

	Specification (規格)	Material (材質)	Quantity (數量)
Luminous Intensity(Iv) (發光強度)	Red : 26 mcd typical Green : 37 mcd typical Blue : 7.5 mcd typical R@5mA;G/B@2mA/ Ts= 25° C; Tolerance ±10%		
Wavelength (波長)	Red : 621 nm typical Green : 531 nm typical Blue : 470 nm typical R@5mA;G/B@2mA/ Ts= 25° C;Tolerance ± 0.5nm		
Vf (順向電壓)	Red : 2.4 V maximum Green : 3.1 V maximum Blue : 3.1 V maximum R@5mA;G/B@2mA/ Ts= 25° C;Tolerance ± 0.05V		
Ir (逆向電流)	< =1 μA @ V _R = 5 V		
Resin (樹脂)	Dark (黑)	Epoxy (環氧樹脂)	
Carrier tape (載帶)	EIA 481-1A specs (EIA 481-1A 規格)	Conductive black tape (黑色導電捲帶)	24000pcs/reel (24000 顆/捲)
Reel (捲帶)	EIA 481-1A specs (EIA 481-1A 規格)	Conductive black (黑色導電帶)	
Label (標籤)	HT standard (宏齊規範)	Paper (紙)	
Packing bag (包裝袋)	250x230mm	Aluminum laminated bag/Zipper (鋁箔帶/有拉鍊)	One reel per bag (每一包裝袋一捲)
Carton (紙箱)	HT standard (宏齊規範)	Paper (紙)	Non-specified 無指定

Official Product	HT Part No. B39D3RGB-F6C0001HOU1930	Customer Part No.	Data Sheet No.
Tentative Product	*****	*****	
Specifications are subject to changes for improvement without advance notice. Proprietary data, drawings, company confidential all rights reserved.		01/09/2020	Version 1.0
			Page 4/19

Others:

Each immediate box consists of 28 reels. The 28 reels may not necessarily have the same lot number or the same bin combinations of I_v , λ_D and V_f . Each reel has a label identifying its specification; the immediate box consists of a product label.

(每一中箱有 28 捲捲帶，28 捲的捲帶不一定有一致的亮度、波長、順向偏壓或是批號。每一份捲帶都有其標籤定義出規格)

Note :This is shipped test conditions

(註：此為出廠檢驗條件)

※Remarks: This product should be operated in forward bias. If a reverse voltage is continuously applied to the product, such operation can cause migration resulting in LED damage.

(※備註：產品應於順向偏壓下操作，假如長期使用於逆向偏壓下可能形成電致遷移導致 LED 損壞。)

ATTENTION: Electrostatic Discharge (ESD) protection

(注意！！靜電放電保護)



The symbol to the left denotes that ESD precaution is needed. ESD protection for GaP and AlGaAs based chips is necessary even though they are relatively safe in the presence of low static-electric discharge. Parts built with AlInGaP, GaN, or/and InGaN based chips are **STATIC SENSITIVE devices**. ESD precaution must be taken during design and assembly.

If manual work or processing is needed, please ensure the device is adequately protected from ESD during the process.

(左圖為須做靜電保護標誌。晶片中磷化鎵和砷化鎵鎵即便是在有相當安全的靜電放電的措施下，對於 ESD 的保護還是必要的。建構於磷化鎵鎵、氮化鎵或氮化鎵鎵的晶片都是靜電敏感元件。在設計與組件中作的靜電保護都是必須的。

假設人工作業程序是必須的，須確保設備製程是擁有靜電保護的程序)

Official Product	HT Part No. B39D3RGB-F6C0001HOU1930	Customer Part No.	Data Sheet No.
Tentative Product	*****	*****	
Specifications are subject to changes for improvement without advance notice. Proprietary data, drawings, company confidential all rights reserved.		01/09/2020	Version 1.0
			Page 5/19

Label Specifications(標籤規格)

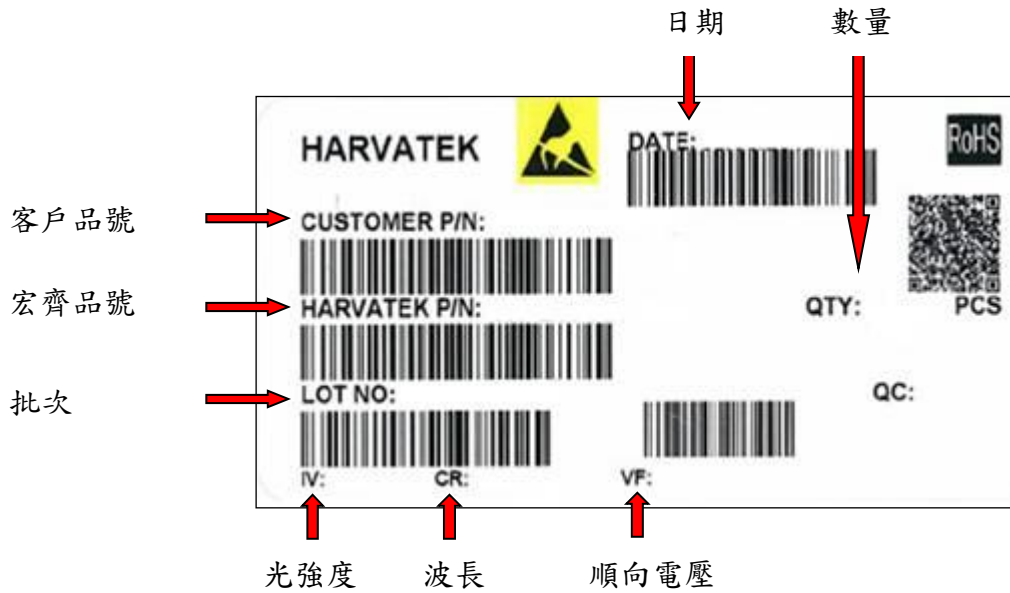

Harvatek P/N: (宏齊品名)

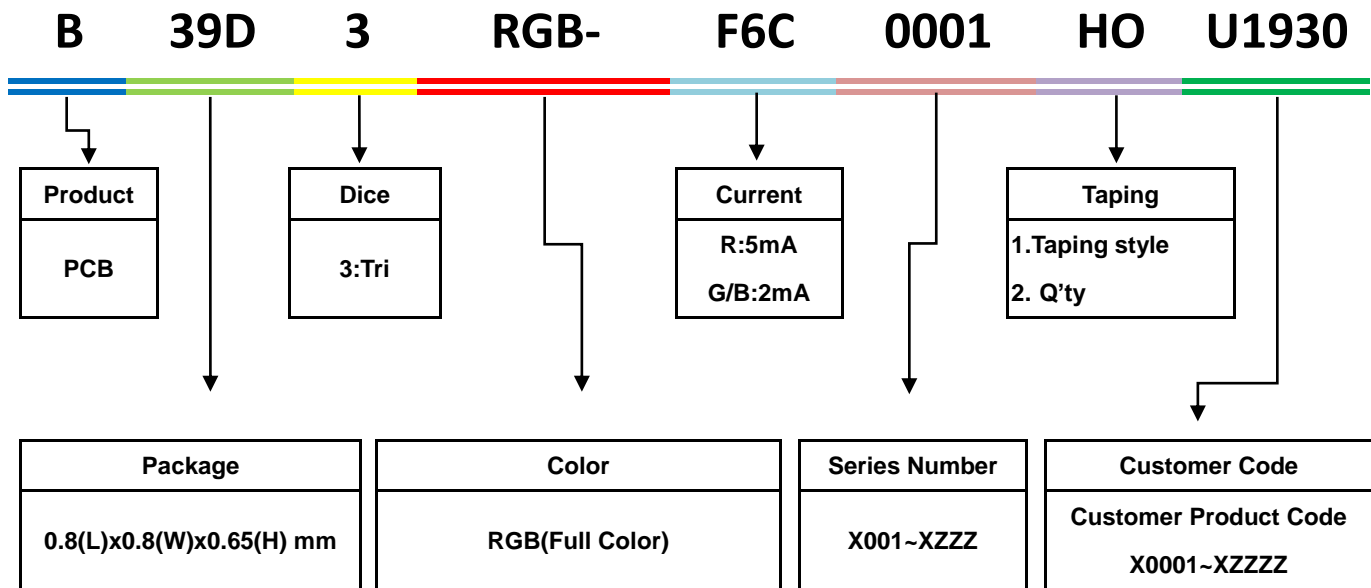

Official Product	HT Part No. B39D3RGB-F6C0001HOU1930	Customer Part No.	Data Sheet No.
Tentative Product	*****	*****	
Specifications are subject to changes for improvement without advance notice. Proprietary data, drawings, company confidential all rights reserved.		01/09/2020	Version 1.0
			Page 6/19

■ Lot No.(批次)

1	2	3	4	5	6	7	8	9	10
1	7	N	E	4	1	L	N	1	1
Code 1 2		Code 3	Code 4	Code 5	Code 6	Code 7	Code 8	Code 9	Code 10
			Mfg.Year	Mfg.Month	Consecutive number		Special code		
Internal Tracing Code		Mixing Lot No.	2010-A 2011-B 2012-C 2013-D 2014-E . . .	1:Jan 2:Feb A:Oct B:Nov C:Dec	01~ZZ		000~ZZZ		

Official Product	HT Part No. B39D3RGB-F6C0001HOU1930	Customer Part No.	Data Sheet No.
Tentative Product	*****	*****	
Specifications are subject to changes for improvement without advance notice. Proprietary data, drawings, company confidential all rights reserved.		01/09/2020	Version 1.0
			Page 7/19

Specifications Range(規格範圍)

■ Luminous Intensity (Iv) Bin:(發光強度分級)

Luminous Intensity (Iv) Bin: R@5mA;G/B @2mA

HT-B39D3RGB Series								
IV								
Red			Green			Blue		
HF2	19	24	HG1	24	30	HB2	4.8	6
HF3	21.3	26.7	HG2	26.7	33.5	HB3	5.4	6.8
HG1	24	30	HG3	30	37.5	HC1	6	7.5
HG2	26.7	33.5	HH1	33.5	42	HC2	6.8	8.5
HG3	30	37.5	HH2	37.5	47	HC3	7.5	9.4
HH1	33.5	42	HH3	42	52.5	HD1	8.5	10.7

Note: It maintains a tolerance of $\pm 10\%$ on Luminous Intensity

(註：存有 10%的發光強度公差)

Dominant Wavelength (λ_D) Bin:(主波長分級)

HT-B39D3RGB Series								
WD								
Red			Green			Blue		
RH2	618	623	GH1	526	530	BH1	464	468
RH3	623	628	GH2	528	532	BH2	466	470
RH4	628	633	GH3	530	534	BH3	468	472
			GH4	532	536	BH4	470	474
			GH5	534	538			

Note: It maintains a tolerance of $\pm 0.5\text{nm}$ on Color Bin

(註：存有 $\pm 0.5\text{nm}$ 的公差)

Forward Voltage (Vf) Bin:(順向偏壓分級)

HT-B39D3RGB Series								
Vf								
Red			Green			Blue		
E18	1.6	2.4	F2A	2.1	3.1	F2A	2.1	3.1

Note: It maintains a tolerance of $\pm 0.05\text{V}$ on forward voltage measurements

(註：存有 $\pm 0.05\text{V}$ 的公差)

Official Product	HT Part No. B39D3RGB-F6C0001HOU1930	Customer Part No.	Data Sheet No.
Tentative Product	*****	*****	
Specifications are subject to changes for improvement without advance notice. Proprietary data, drawings, company confidential all rights reserved.		01/09/2020	Version 1.0
			Page 8/19

Product Features(產品特色)

Electro-Optical Characteristics(光學特性)

(T_{Soldering}, 25 °C)(焊接溫度 25 度)

Part number (品號)	Emitting Color (發光色)	Forward Voltage(VF) (順向偏壓)		Wavelength (nm) typ. (波長)			I _v [*] (mcd) 光強度	Viewing Angle 2θ1/2 (發光角)
		typ.	max.	λD	λp	Δλ	typ.	
B39D3RGB-F6C0001HOU1930	Ultra Bright Red	1.9	2.4	621	630	11	26	140
	Green	2.5	3.1	530	521	28	37	140
	Blue	2.5	3.1	471	467	16	7.5	140

Package Outline Dimension and Recommended Soldering Pattern for Reflow Soldering

(封裝外形尺寸與建議的焊盤尺寸)

Unit: mm Tolerance: +/-0.1

(單位：誤差為 +/-0.1 毫米)

Outline Dim.(外形尺寸)	Soldering Pattern(焊接圖面)

Soldering terminals may shift in the x, y direction.(焊點可能會隨 x,y 方向偏移)

Official Product	HT Part No. B39D3RGB-F6C0001HOU1930	Customer Part No.	Data Sheet No.
Tentative Product	*****	*****	
Specifications are subject to changes for improvement without advance notice. Proprietary data, drawings, company confidential all rights reserved.		01/09/2020	Version 1.0
			Page 9/19

Absolute Maximum Ratings(絕對最大額定值)

(T_s 25 °C)

Series (系列)	P _D (mW) (消耗功率)	I _F (mA) (順向電流)	IFP (mA) (脈衝順向電流)	VR (反向電壓)	T _{OP} (°C) (操作溫度)	T _{ST} (°C) (儲存溫度)
Color	Power Dissipation	Forward Current	Pulse Forward Current	Reverse Voltage	Operation Temperature	Storage Temperature
Red	24.4	5	20	5	-30~+80	-40~+85
Blue/Green		2				

** Condition for I_{FP} is pulse of 1/10 duty and 0.1msec width

(I_{FP}的脈衝條件為 1/10 占空比與 0.1m 秒脈衝寬度)

Remarks: This product should be operated in forward bias. If a reverse voltage is continuously applied to the product, such operation can cause migration resulting in LED damage.

此產品應於正向操作，若連續施加反向電壓或電流，易造成 LED 損壞

Official Product	HT Part No. B39D3RGB-F6C0001HOU1930	Customer Part No.	Data Sheet No.
Tentative Product	*****	*****	
Specifications are subject to changes for improvement without advance notice. Proprietary data, drawings, company confidential all rights reserved.		01/09/2020	Version 1.0
			Page 10/19

Characteristics of B39D3RGB-F6

Relative Intensity vs. Forward Current
(相對光強度與順向電流變化圖)

Relative Intensity vs. Forward Current

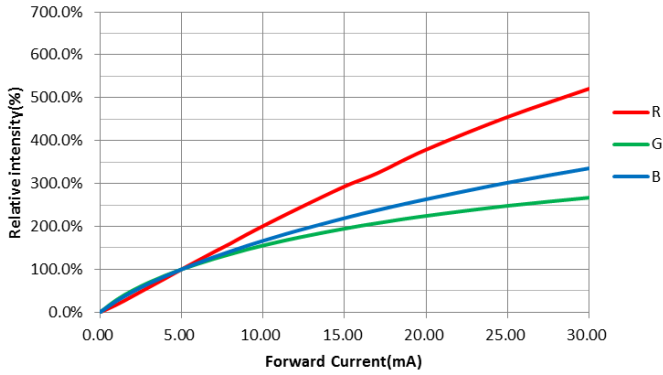

Forward Voltage vs. Forward Current
(順向偏壓與順向電流對應圖)

Forward voltage vs. Forward Current

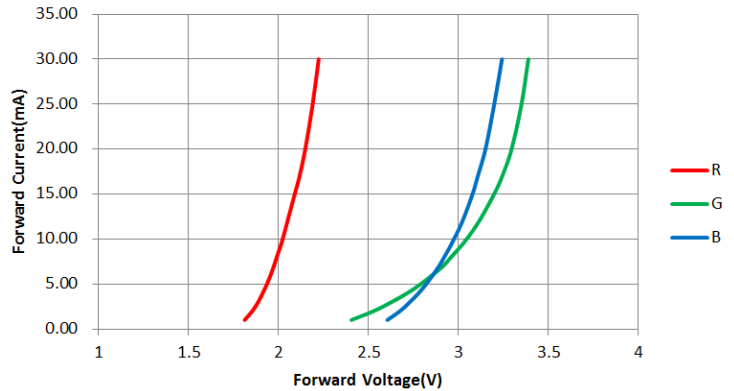

Forward Current vs. Ambient Temperature
(順向電流與環境溫度變化圖)

Forward Current VS. Ambient Temperature

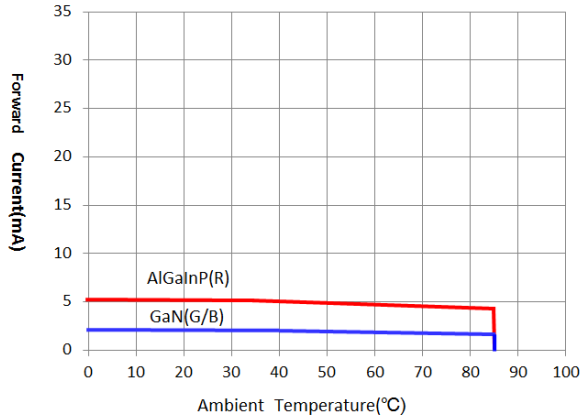

Wavelength vs. Forward Current
(波長與順向電流變化圖)

Wavelength vs. Forward Current

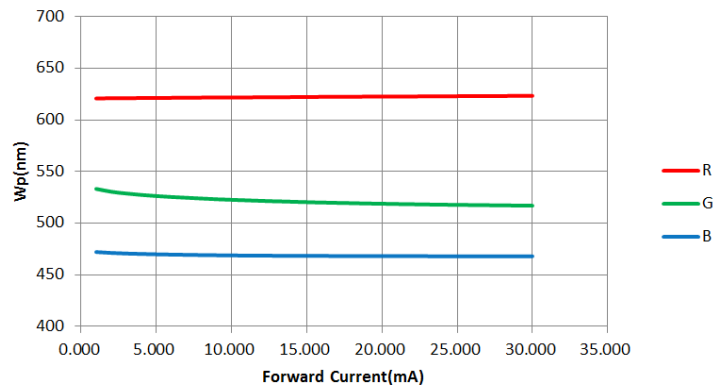

Official Product	HT Part No. B39D3RGB-F6C0001HOU1930	Customer Part No.	Data Sheet No.
Tentative Product	*****	*****	
Specifications are subject to changes for improvement without advance notice. Proprietary data, drawings, company confidential all rights reserved.		01/09/2020	Version 1.0
			Page 11/19

Radiation Diagram(發光角度圖)

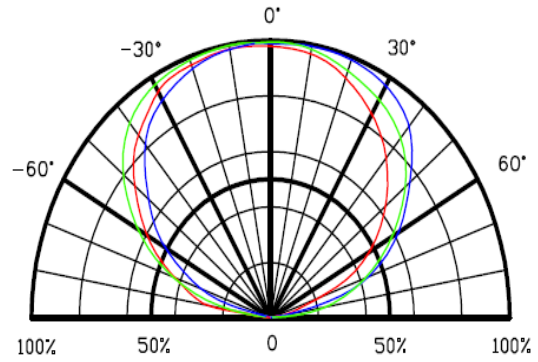
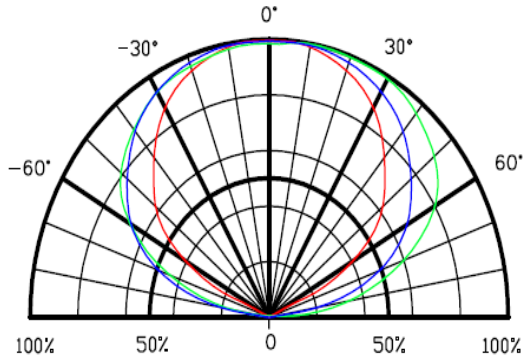

Official Product	HT Part No. B39D3RGB-F6C0001HOU1930	Customer Part No.	Data Sheet No.
Tentative Product	*****	*****	
Specifications are subject to changes for improvement without advance notice. Proprietary data, drawings, company confidential all rights reserved.		01/09/2020	Version 1.0
			Page 12/19

Precaution for Use(使用注意事項)

1. The chips should not be used directly in any type of fluid such as water, oil, organic solvent, etc.(晶片不可被直接用於任何液體，例如水、油、有機溶劑等等)
2. When the LEDs are illuminating, the maximum ambient temperature should be first considered before operation.(使用此 LED 前，應在操作前先確認環境的最高溫度)
3. LEDs must be stored in a clean environment. A sealed container with a nitrogen atmosphere is necessary if the storage period is over 3 months after shipping.
(LEDS 應存於一個乾淨的環境。如使用後要保存超過三個月的時間，需在有氮氣中的密閉空間下)
4. The LEDs must be used within seven days after unpacked. Unused products must be repacked in an anti-electrostatic package, folded to close any opening and then stored in a dry and cool space.
(LED 必須在開封後七天內使用。未使用的產品必須被重新包裝在防靜電包裝內，折疊封閉任何開口，並存放在乾燥、陰涼的空間)
5. The appearance and specifications of the products may be modified for improvement without further notice.
(產品的外觀和規格可能被修改或改善，恕不另行通知。)
6. The LEDs are sensitive to the static electricity and surge. It is strongly recommended to use a grounded wrist band and anti-electrostatic glove when handling the LEDs. If a voltage over the absolute maximum rating is applied to LEDs, it will damage LEDs. Damaged LEDs will show some abnormal characteristics such as remarkable increase of leak current, lower turn-on voltage and getting unlit at low current.
(LED 對靜電敏感。強烈建議在處理 LED 時要使用接地手環，防靜電手套。當電壓超過絕對最大額定值，會損壞 LED。損壞的 LED 會顯示一些異常特徵，如漏電流顯著增加，較低的導通電壓，並在低電流下不亮。)

Official Product	HT Part No. B39D3RGB-F6C0001HOU1930	Customer Part No.	Data Sheet No.
Tentative Product	*****	*****	
Specifications are subject to changes for improvement without advance notice. Proprietary data, drawings, company confidential all rights reserved.		01/09/2020	Version 1.0
			Page 13/19

Packaging(包裝)

Tape Dimension(捲帶尺寸)

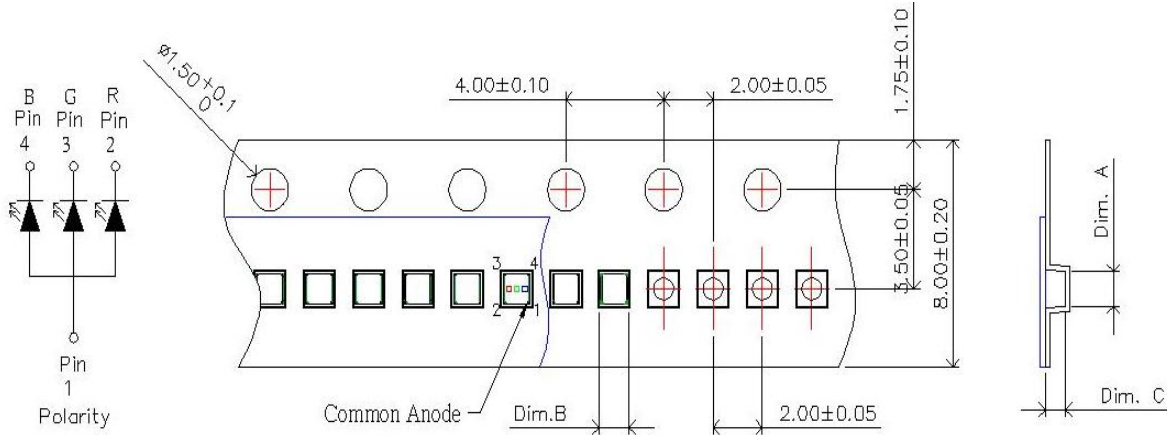

Dim. A (尺寸 A)	Dim. B (尺寸 B)	Dim. C (尺寸 C)	Q'ty/Reel (數量/1 捲)
1.10±0.05	1.12±0.05	0.75±0.05	24K

Unit: mm(單位：毫米)

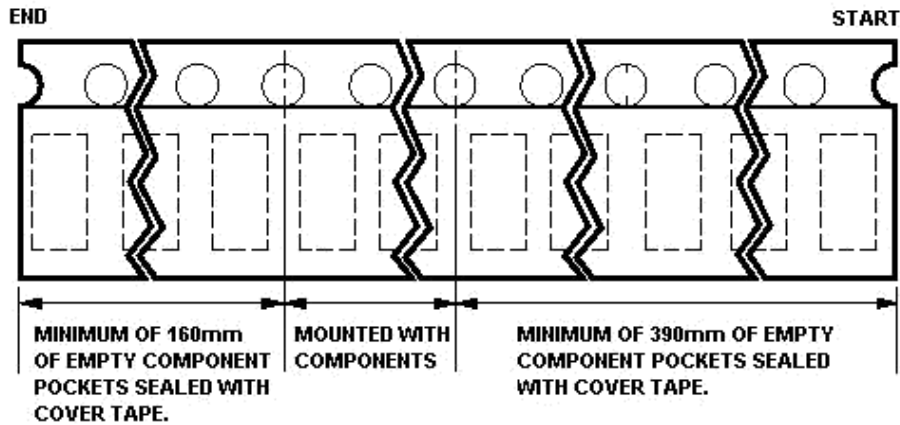

Official Product	HT Part No. B39D3RGB-F6C0001HOU1930	Customer Part No.	Data Sheet No.
Tentative Product	*****	*****	
Specifications are subject to changes for improvement without advance notice. Proprietary data, drawings, company confidential all rights reserved.		01/09/2020	Version 1.0
			Page 14/19

Reel Dimension(捲盤尺寸)

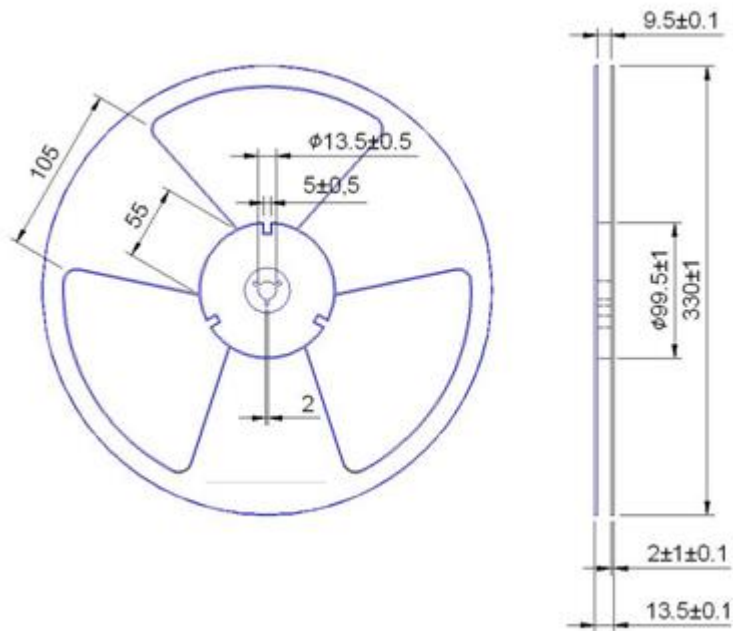

Packing(包裝方式)

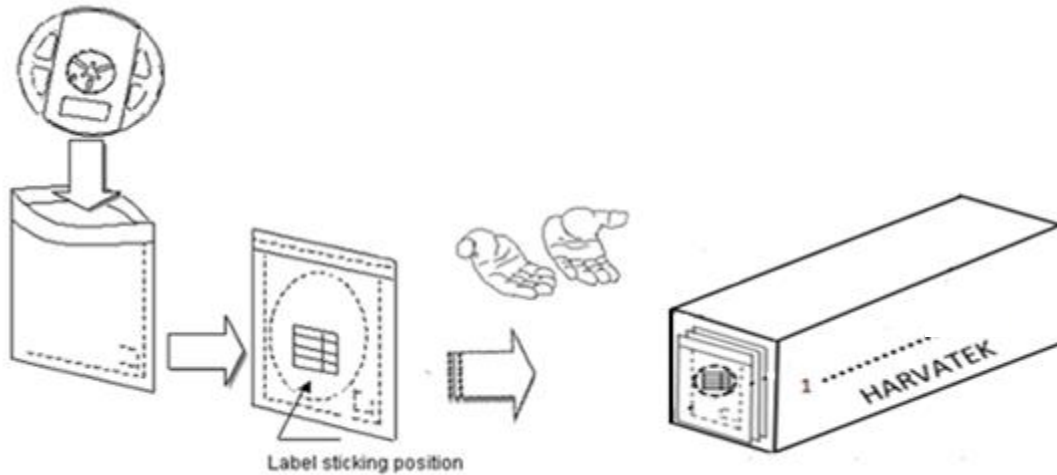

28 boxes per carton is available depending on shipment quantity.

(裝貨量每一紙箱可裝載 28 袋)

Official Product	HT Part No. B39D3RGB-F6C0001HOU1930	Customer Part No.	Data Sheet No.
Tentative Product	*****	*****	
Specifications are subject to changes for improvement without advance notice. Proprietary data, drawings, company confidential all rights reserved.		01/09/2020	Version 1.0
			Page 15/19

Dry Pack(乾燥包裝方法)

All SMD optical devices are **MOISTURE SENSITIVE**. Avoid exposure to moisture at all times during transportation or storage. Every reel is packaged in a moisture protected anti-static bag. Each bag is properly sealed prior to shipment.

(表面黏著光學元件是對濕氣敏感的。每個捲軸被包裝在防潮保護的防靜電袋裡，每袋發貨前需密封，避免在任何時候運輸或儲存過程中接觸濕氣。)

Upon request, a humidity indicator will be included in the moisture protected anti-static bag prior to shipment.

(根據要求，會在出貨前將濕度指示卡裝入被受保護的防靜電袋裡)

The packaging sequence is as follows: (包裝順序如下)

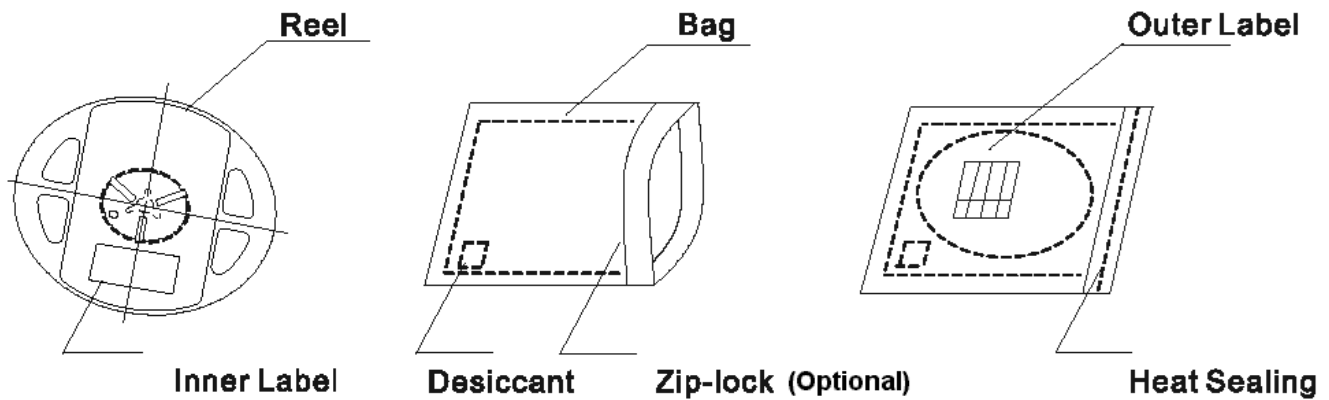

Baking(烘烤)

Baking before soldering is recommended when the package has been unsealed for 4 weeks.

(當包裝已開封四週,在焊接時建議先烘烤)

The conditions are as followings:

MBB open ≤ 672hrs, 50±3°C × (3hrs)

MBB open > 672hrs, 60±3°C × (8~12hrs) and < 5%RH, taped reel type.

100±3°C × (45min~1hr), bulk type.(散裝)

130±3°C × (15min~30min), bulk type.(散裝)

Official Product	HT Part No. B39D3RGB-F6C0001HOU1930	Customer Part No.	Data Sheet No.
Tentative Product	*****	*****	
Specifications are subject to changes for improvement without advance notice. Proprietary data, drawings, company confidential all rights reserved.		01/09/2020	Version 1.0
			Page 16/19

PRECAUTIONS(注意事項)

1. Avoid exposure to moisture at all times during transportation or storage.
(避免在任何運輸或儲存的過程中接觸濕氣)
2. Anti-Static precaution must be taken when handling GaN, InGaN, and AlInGaP products.
(處理氮化鎵，氮化銦鎵及磷化鋁銦鎵產品時，必須採取防靜電措施)
3. It is suggested to connect the unit with a current limiting resistor of the proper size. Avoid applying a reverse voltage beyond the specified limit.
(建議該元件應具有適當大小的限流電阻連接。避免施加反向電壓超出規定限定值。)
4. Avoid operation beyond the limits as specified by the absolute maximum ratings.
(避免操作超出所指定的絕對最大額定值)
5. Avoid direct contact with the surface through which the LED emits light.
(LED 發光時，避免與表面直接接觸)
6. If possible, assemble the unit in a clean room or dust-free environment.
(如果可能的話，組裝程序應在潔淨室或無塵環境)

Reflow Soldering(迴流焊)

Recommend soldering paste specifications: (推薦焊錫規格)

1. Operating temp.: Above 220 °C, 60sec (操作溫度： 220 度以上 60 秒)
2. Peak temp.: 260 °C Max., 10sec Max. (峰值溫度：最高 260 度、最多 10 秒)
3. Never take next process until the component is cooled down to room temperature after reflow. (不做任何步驟,直到元件恢復常溫後再溶焊)
4. The recommended reflow soldering profile (measuring on the surface of the LED terminal) is following: (推薦的迴流焊溫度曲線 (測量 LED 的終端表面上) 如下述：)
Lead-free Solder Profile 無鉛焊料簡介
5. Reflow soldering should not be done more than two times 迴流焊不可執行超過兩次

Official Product	HT Part No. B39D3RGB-F6C0001HOU1930	Customer Part No.	Data Sheet No.
Tentative Product	*****	*****	
Specifications are subject to changes for improvement without advance notice. Proprietary data, drawings, company confidential all rights reserved.		01/09/2020	Version 1.0
			Page 17/19

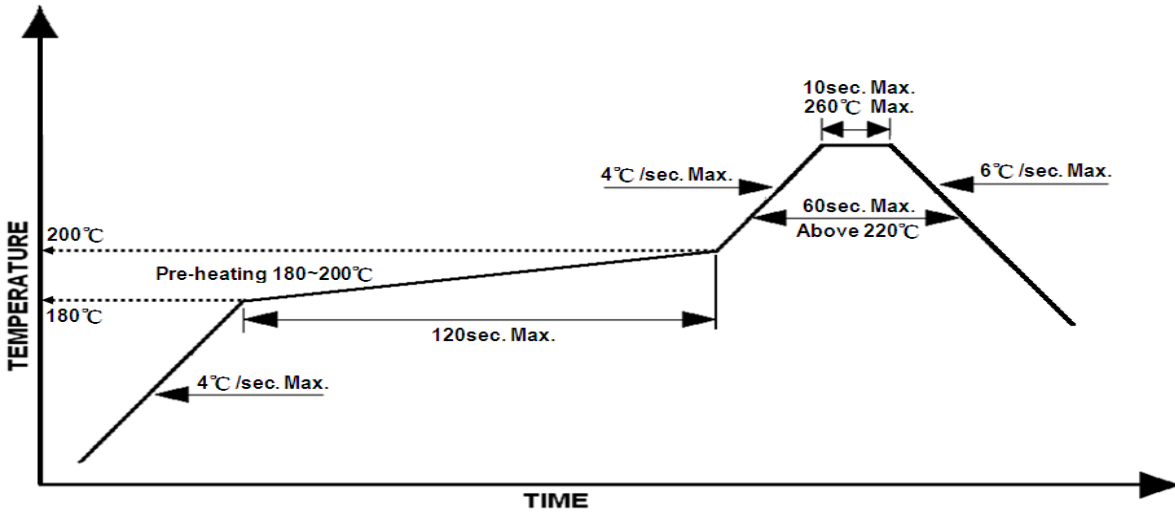

Temperature vs. Time
(溫度與時間對應圖)

Reworking(重工)

- Rework should be completed within 5 seconds under 260 °C.(重工需在 260 溫度下 5 秒內)
- The iron tip must not come in contact with the copper foil. (烙鐵頭必須不與銅箔接觸)
- Twin-head type is preferred.(雙頭型為首選)。

Cleaning(清潔)

Following are cleaning procedures after soldering: (下述為是焊接後清洗程序)

- An alcohol-based solvent such as isopropyl alcohol (IPA) is recommended.
(建議醇系溶劑，如異丙醇)
- Temperature x Time should be 50°C x 30sec. or <30°C x 3min
(溫度 x 時間需 50°C x 30 秒或<30°C x 3 分)
- Ultra sonic cleaning: < 15W/ bath; bath volume ≤ 1liter
(超音波清潔：小於 15W / 洗滌; 洗滌值 ≤ 1 升)
- Curing: 100 °C max, <3min
(固化：最大 100 度,小於三分鐘)

Cautions of Pick and Place(拾起與放置注意事項)

- Avoid stress on the resin at elevated temperature.(避免樹脂在高溫下受壓)
- Avoid rubbing or scraping the resin by any object.(避免任何物體刮或摩擦樹脂)
- Electric-static may cause damage to the component. Please ensure that the equipment is properly grounded. Use of an ionizer fan is recommended.
(靜電可能會損壞組件。請確保設備已正確接地。建議使用離子風扇。)

Official Product	HT Part No. B39D3RGB-F6C0001HOU1930	Customer Part No.	Data Sheet No.
Tentative Product	*****	*****	
Specifications are subject to changes for improvement without advance notice. Proprietary data, drawings, company confidential all rights reserved.		01/09/2020	Version 1.0
			Page 18/19

