

Features

- ESD Protection for 1 Line with Bi-directional
- Provide ESD protection for each line to **IEC 61000-4-2 (ESD) $\pm 15\text{kV}$ (air) / $\pm 8\text{kV}$ (contact)**
- **Ultra low capacitance: 0.1pF typical**
- **For low operating voltage of 5V and below**
- **0201 small CSP package** saves board space
- Protect one high-speed I/O line
- Fast turn-on and low clamping voltage
- Solid-state silicon-avalanche and active circuit triggering technology
- **Green part**

Applications

- Thunderbolt Interface
- USB3.1 Interface
- High Speed Data Lines Protection
- Serial and Parallel Port Protection
- Hand Held Portable Applications
- Computer Interfaces Protection
- Microprocessors Protection
- Mobile Phones

Description

AZ5B75-01B is a design which includes a bi-directional ESD rated clamping cell to protect one high speed data line in an electronic system. The AZ5B75-01B has been specifically designed to protect sensitive components which are connected to high speed data lines from over-voltage damage caused by Electrostatic Discharging (ESD) and Cable Discharge Event (CDE).

AZ5B75-01B is a unique design which includes proprietary clamping cell in a single package. During transient conditions, the proprietary clamping cell prevents over-voltage on the high speed data lines, protecting any downstream components.

AZ5B75-01B is bi-directional and may be used on lines where the signal swings above and below ground.

AZ5B75-01B may be used to meet the ESD immunity requirements of IEC 61000-4-2, Level 4 ($\pm 15\text{kV}$ air, $\pm 8\text{kV}$ contact discharge).

Circuit Diagram / Pin Configuration

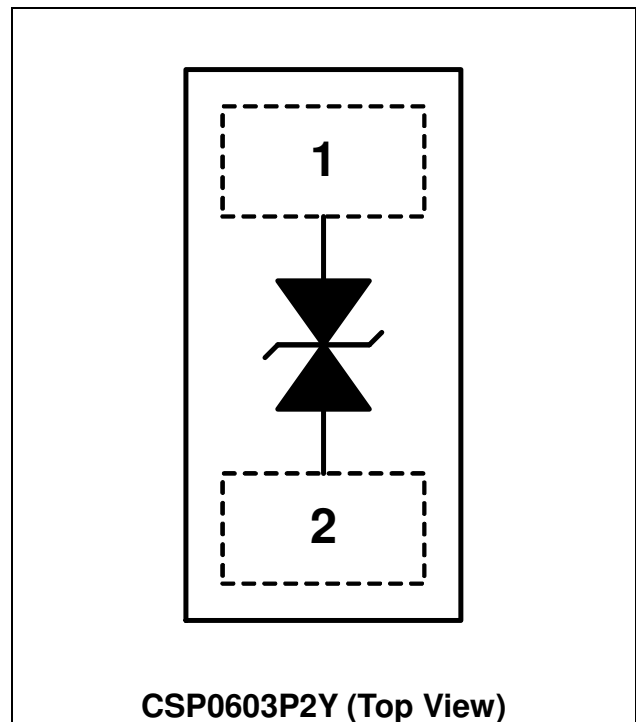



SPECIFICATIONS

ABSOLUTE MAXIMUM RATINGS			
PARAMETER	SYMBOL	RATING	UNITS
Operating Supply Voltage	V_{DC}	± 5.5	V
ESD per IEC 61000-4-2 (Air)	V_{ESD-1}	± 15	kV
ESD per IEC 61000-4-2 (Contact)	V_{ESD-2}	± 8	
Lead Soldering Temperature	T_{SOL}	260 (10 sec.)	$^{\circ}C$
Operating Temperature	T_{OP}	-55 to +85	$^{\circ}C$
Storage Temperature	T_{STO}	-55 to +150	$^{\circ}C$

ELECTRICAL CHARACTERISTICS						
PARAMETER	SYMBOL	CONDITIONS	MINI	TYP	MAX	UNITS
Reverse Stand-Off Voltage	V_{RWM}	$T = 25^{\circ}C$.	-5		5	V
Reverse Leakage Current	I_{Leak}	$V_{RWM} = \pm 5.0V, T = 25^{\circ}C$.			100	nA
Reverse Breakdown Voltage	V_{BV}	$I_{BV} = 1mA, T = 25^{\circ}C$.	6		9	V
ESD Clamping Voltage (Note 1)	V_{clamp}	IEC 61000-4-2 +8kV ($I_{TLP} = 16A$), Contact mode, $T = 25^{\circ}C$.		18		V
ESD Dynamic Turn-on Resistance	$R_{dynamic}$	IEC 61000-4-2 0 ~ +8kV, $T = 25^{\circ}C$, Contact mode.		0.7		Ω
Channel Input Capacitance	C_{IN}	$V_R = 2.5V, f = 1MHz, T = 25^{\circ}C$.			0.2	pF
		$V_R = 2.5V, f = 1GHz, T = 25^{\circ}C$.		0.1		pF

Note 1: ESD Clamping Voltage was measured by Transmission Line Pulsing (TLP) System.

TLP conditions: $Z_0 = 50\Omega, t_p = 100ns, t_r = 1ns$.



Typical Characteristics

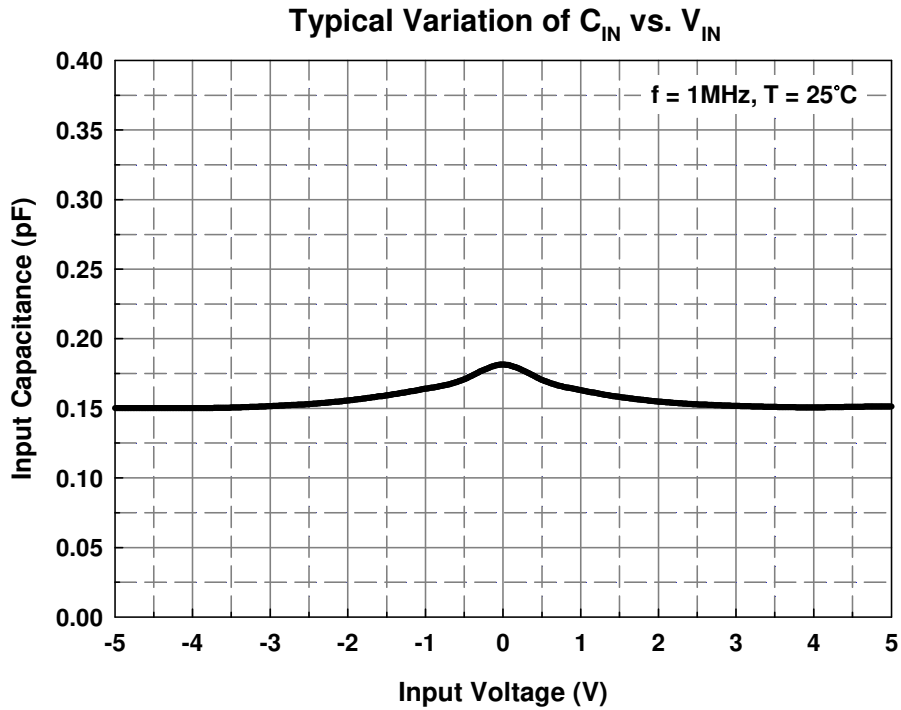
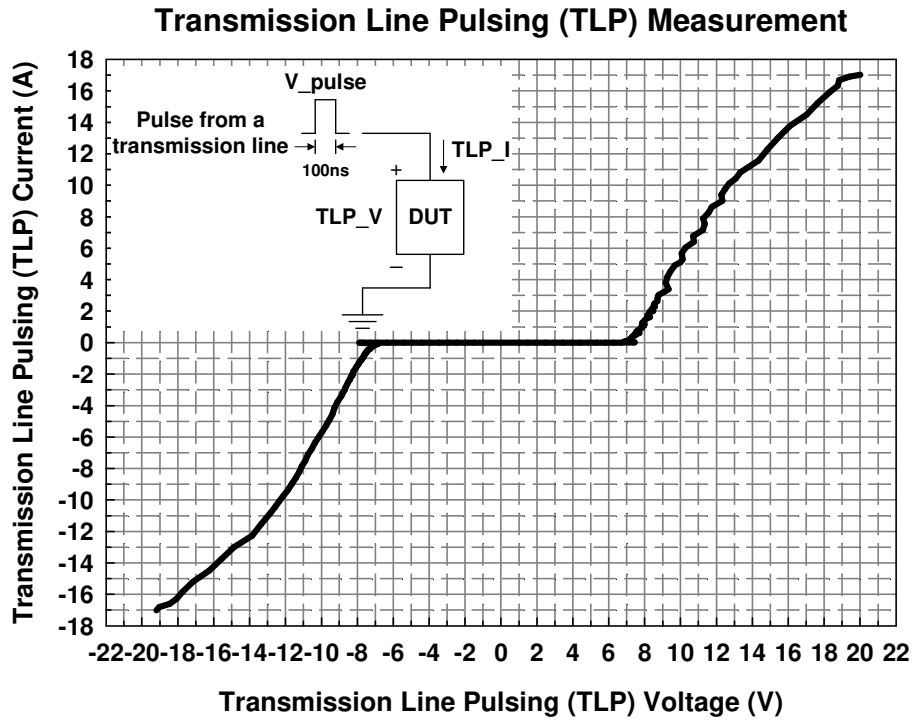



Applications Information

The AZ5B75-01B is designed to protect one line against system ESD pulses by clamping it to an acceptable reference. It provides bi-directional protection.

The usage of the AZ5B75-01B is shown in Fig. 1. Protected line, such as high speed data line, is connected at pin 1. The pin 2 is connected to a ground plane on the board. In order to minimize parasitic inductance in the board traces, all path lengths connected to the pins of AZ5B75-01B should be kept as short as possible.

In order to obtain enough suppression of ESD induced transient, good circuit board is critical.

Thus, the following guidelines are recommended:

- Minimize the path length between the protected lines and the AZ5B75-01B.
- Place the AZ5B75-01B near the input terminals or connectors to restrict transient coupling.
- The ESD current return path to ground should be kept as short as possible.
- Use ground planes whenever possible.
- NEVER route critical signals near board edges and near the lines which the ESD transient easily injects to.

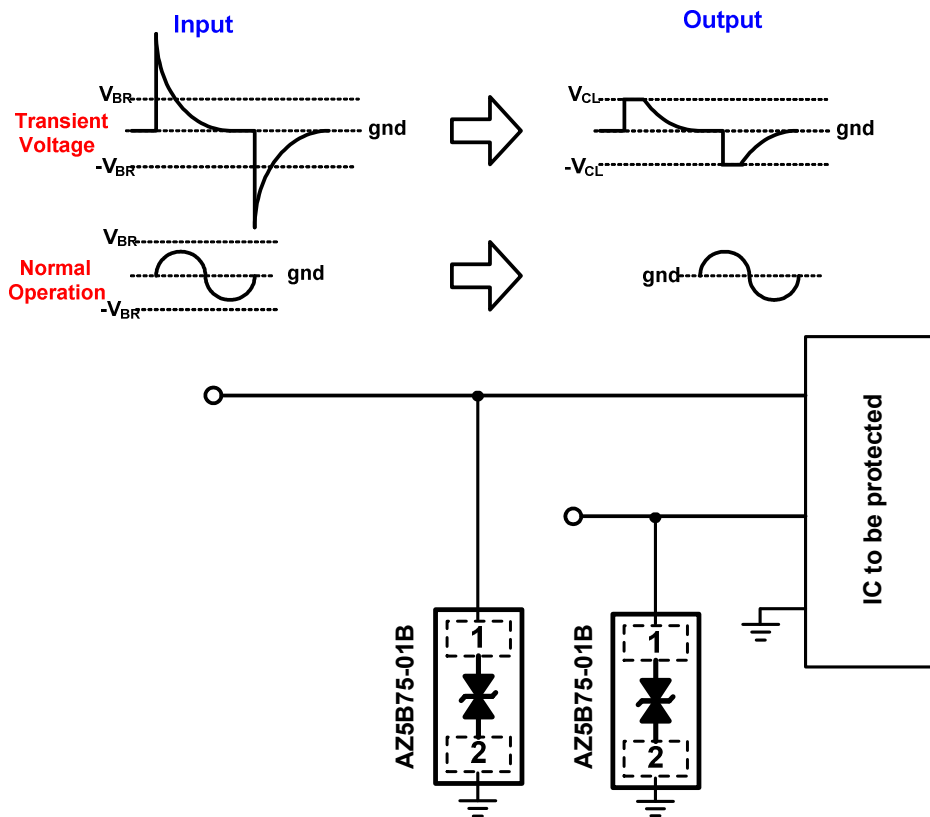
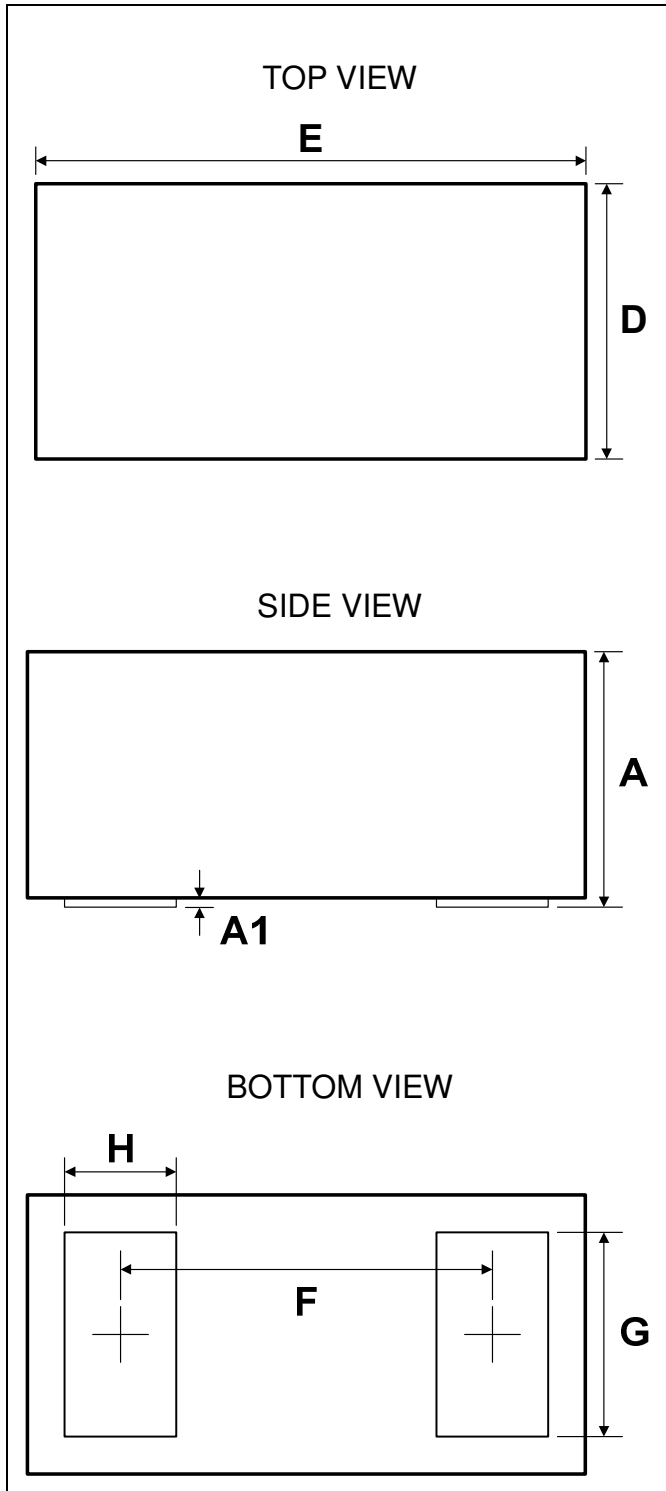

Fig. 1 ESD protection scheme by using AZ5B75-01B.

Mechanical Details

CSP0603P2Y

PACKAGE DIAGRAMS



PACKAGE DIMENSIONS

Symbol	Millimeters		
	MIN.	TYP.	MAX.
D	0.275	0.300	0.325
E	0.575	0.600	0.625
A	0.256	0.276	0.296
A1		0.011	
F		0.400	
G	0.210	0.220	0.230
H	0.110	0.120	0.130

LAND LAYOUT

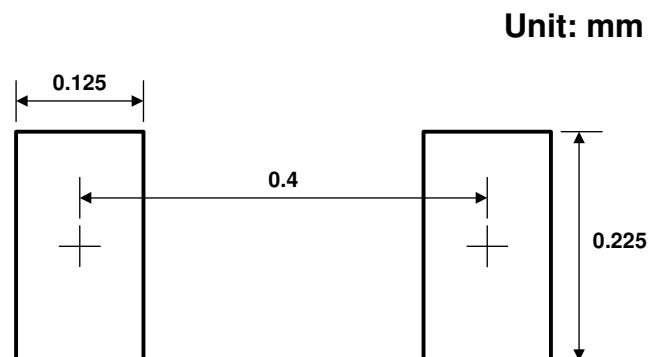

Notes:

This LAND LAYOUT is for reference purposes only. Please consult your manufacturing partners to ensure your company's PCB design guidelines are met.

MARKING CODE

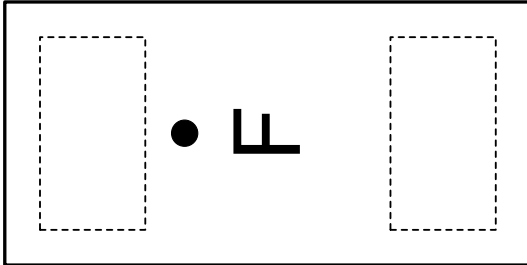

Part Number	Marking Code
AZ5B75-01B.R7G (Green Part)	F

Note. Green means Pb-free, RoHS, and Halogen free compliant.

F = Device Code

Ordering Information

PN#	Material	Type	Reel size	MOQ	MOQ/internal box	MOQ/carton
AZ5B75-01B.R7G	Green	T/R	7 inch	15,000/reel	4 reels =60,000/box	6 boxes =360,000/carton

Revision History

Revision	Modification Description
Revision 2016/09/02	Preliminary Release.
Revision 2017/05/17	Formal Release.