

UBR Series

Ultra-Broadband Resistors

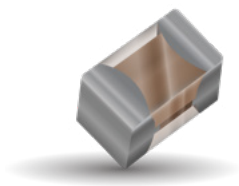

GENERAL DESCRIPTION

Passive Micro Component group is pleased to introduce the UBR Series of next generation of surface mount Ultra-Broadband Resistors. This product was designed utilizing our proprietary Glass Sandwich Flexiterm® Technology, (GSFT). The Flexiterm® is a surface mountable automotive qualified termination that adds an extra margin against damage due to flexure during installation.

The UBR Series has been designed with high quality selected materials that yield excellent performance. This product is ideal for use in Optical Transceiver Modules or any application requiring excellent ultra-broadband performance. The use of glass sandwich technology and precision laser trimming reduces parasitic noise up to 40 GHz.

FEATURES

- Frequency Range: DC to 40 GHz
- EIA 0402 Case Size
- Power Rating: 125 mW
- Operating Temperature: -40°C to +125°C
- 100% Laser Trimming for Tight Tolerances
- RoHS Compliant

APPLICATIONS

- Optical Transceiver Modules
- Broadband Receiver
- TOSA / ROSA
- Wideband Test Equipment
- Low Noise Amplifier
- MMIC Amplifiers
- Mixers
- Directional Couplers
- Ultra-Broadband Splitters and Combiners

MARKETS

- Opto-electronics
- Automotive
- Telecom
- Broadband Jamming for EW
- Satellite Communication

HOW TO ORDER

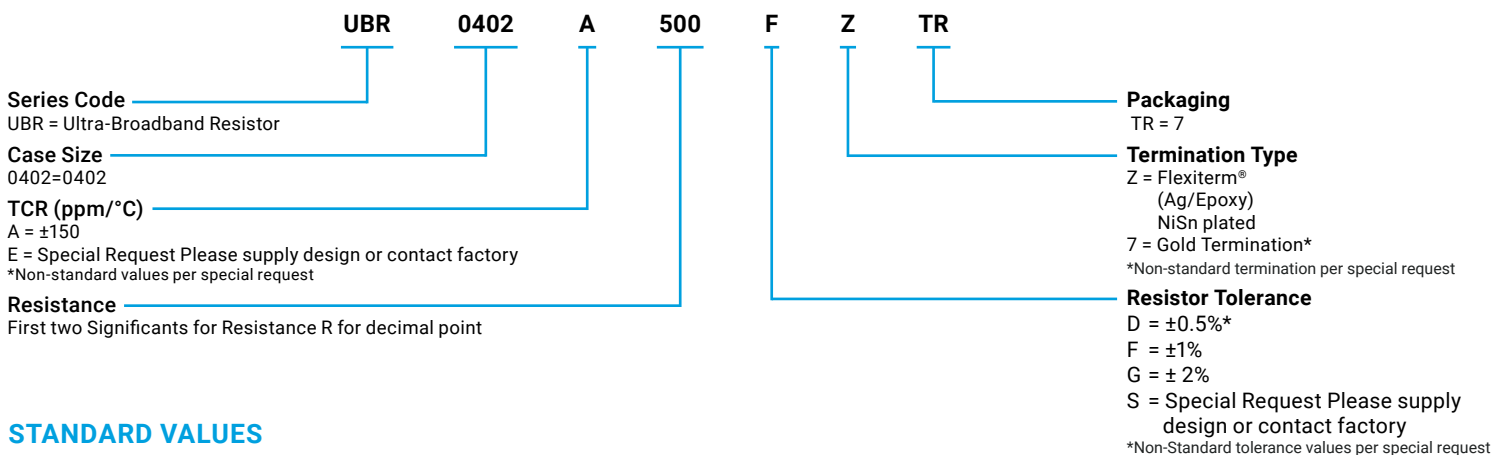

STANDARD VALUES

Part Number	Value(ohm)
UBR0402A250FZTR	25Ω
UBR0402A35R7FZTR	37.5Ω
UBR0402A430FZTR	43Ω
UBR0402A500FZTR	50Ω
UBR0402A750FZTR	75Ω
UBR0402A101FZTR	100Ω
UBR0402A201FZTR	200Ω

Resistors from 10 to 1k Ohm available upon request



CLICK HERE TO DOWNLOAD DATA FILES

*Data files contain DXF and S2P files



LEAD-FREE
LEAD-FREE COMPATIBLE
COMPONENT



For RoHS compliant products, please select correct termination style

UBR Series

Ultra-Broadband Resistors

MECHANICAL DIMENSIONS

mm (inches)

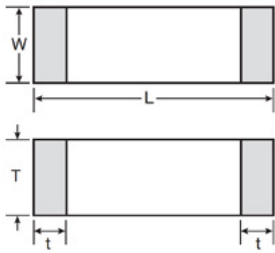

Length (L)	1.00±0.10 (0.039±0.004)
Width (W)	0.50±0.10 (0.020±0.004)
Thickness (T)	0.50±0.10 (0.020±0.004)
Terminal (t)	0.25±0.15 (0.010±0.006)

0402 TYPICAL CHARACTERISTICS

Resistor	Detail
Outline	EIA 0402
Package	Glass wafer sandwich
Maximum Voltage	1 KV
Termination	FLEXITERM® (Ag/Epoxy), plated
Power Rating	125 mW
Operating Temperature Range	-40°C to +125°C

SUGGESTED MOUNTING PAD DIMENSIONS

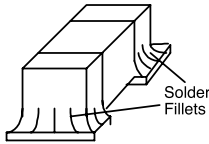

Normal Pads

W = Chip Width L = Chip Length T = Chip Thickness

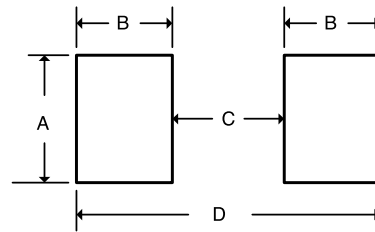

Case Size	A Min.	B Min.	C Min.	D Min.
0402	0.54 (0.0213)	0.3175 (0.0125)	0.523 (0.0206)	1.107 (0.0436)

Dimensions are in inches.

NOTES:

Mounting will allow the solder fillet to travel up approximately 0.015" of the chip's end and side termination surface. Heavier fillets require a predeposition of solder paste and or an increase in pad dimensions. Typical solder paste application is a .008" to 0.01" thickness with >50% of volume in solder alloy. Can be mounted in both vertical and horizontal orientation without changing electrical performance

POWER DERATING

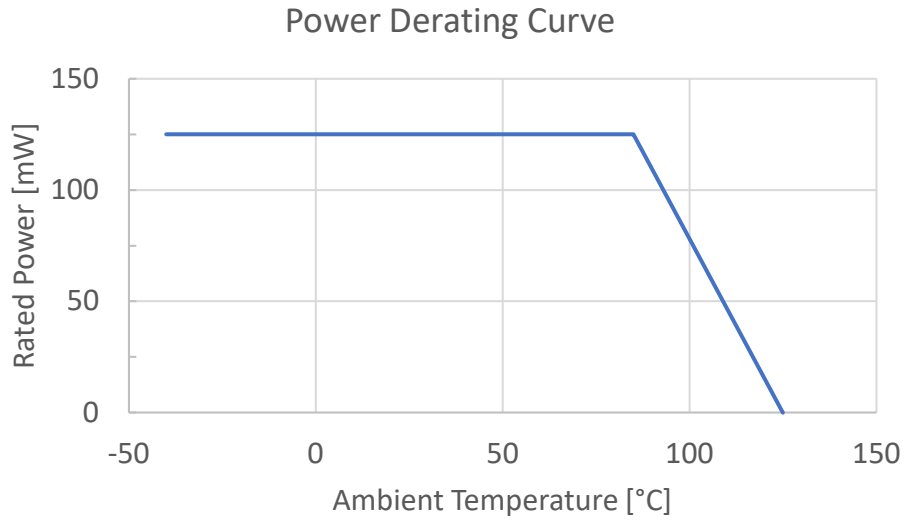

ENVIRONMENTAL TEST

Test	Limits	Specification
Life Test/Stability	±0.25% Max Δ R/R	MIL-STD-202 MTD 108, 1000hrs, 125°C, 50mW
Thermal Shock	±0.25% Max Δ R/R	MIL-STD-202 MTD 107
High Temperature Exposure	±0.25% Max Δ R/R	100 Hrs @ 150°C
Moisture Resistance	±0.25% Max Δ R/R	MIL-STD-202 MTD 106

UBR Series

Ultra-Broadband Resistors



INTERNAL IMPEDANCE CURVES

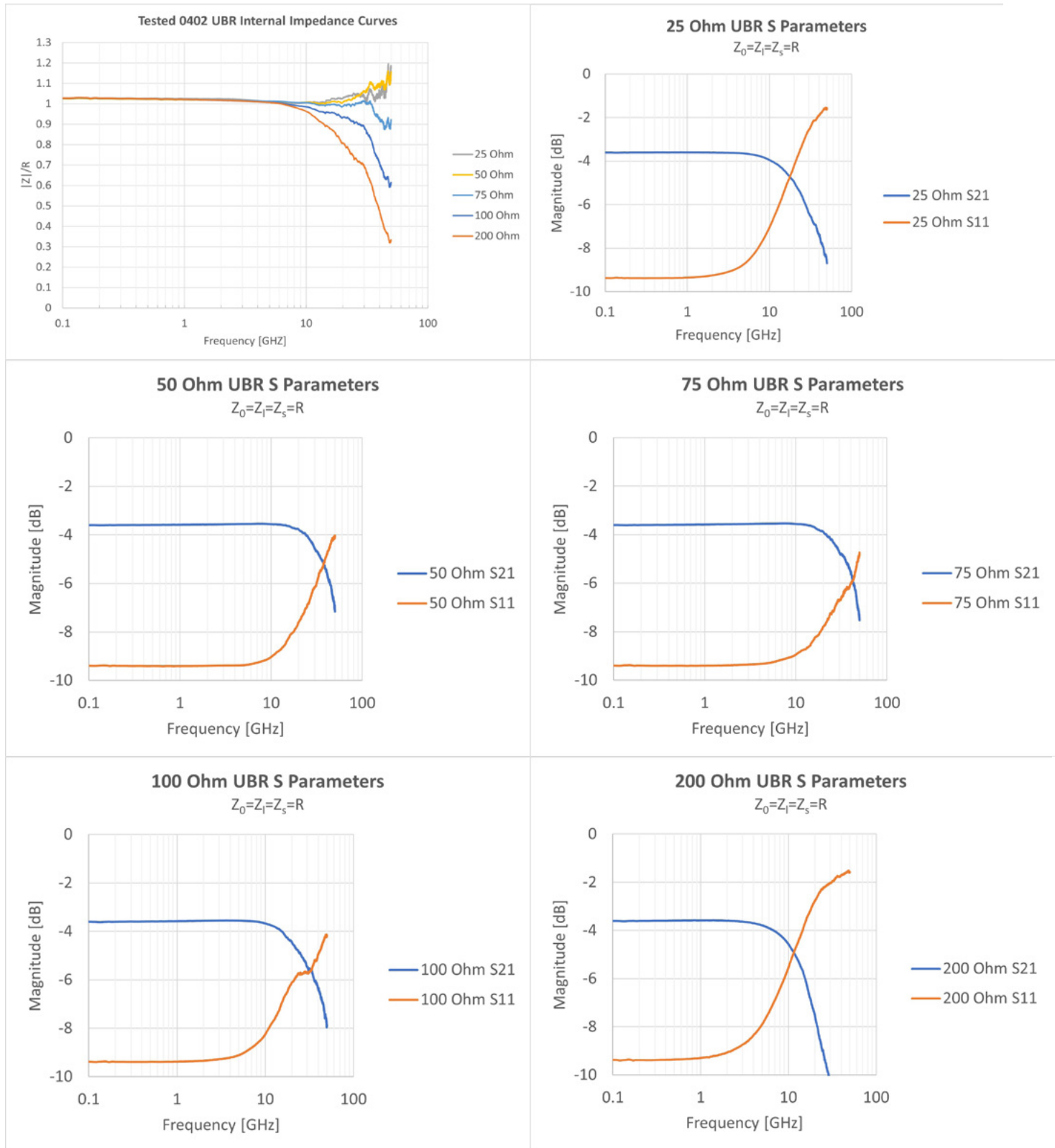

NOTES: All testing done by Modelithics