

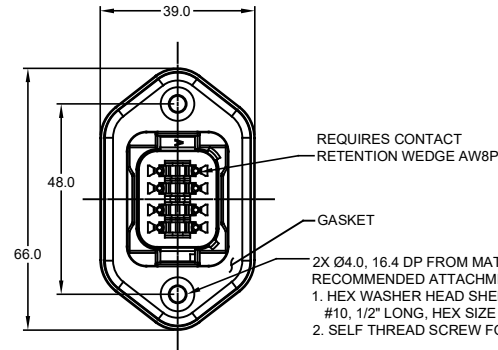

MOUNTING PLATE SIZE

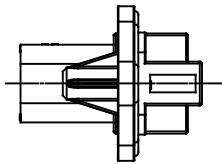
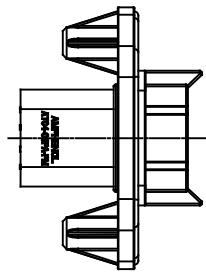
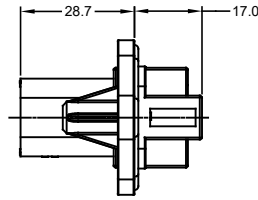

△ STANDARD OR REDUCED DIAMETER SEAL

NOTES: UNLESS OTHERWISE SPECIFIED

1. MATERIAL:
  - HOUSING: THERMOPLASTIC; COLOR: PER KEY OPTION
  - END CAP: THERMOPLASTIC; COLOR: BLACK
  - STRAIN RELIEF CAP: THERMOPLASTIC; COLOR: BLACK
  - SEALS: SILICONE RUBBER; COLOR: RED
2. MODIFICATIONS: FLANGE, GASKET, END CAP (OPT), STRAIN RELIEF CAP (OPT), REDUCED DIAMETER SEAL (OPT).
3. SPECIFICATIONS:
  - 3.1 CURRENT RATING: 13 AMPS
  - 3.2 OPERATING TEMPERATURE: -55°C TO +125°C
  - 3.3 DIELECTRIC WITHSTANDING VOLTAGE: LESS THAN 2 MILLIAMPS CURRENT LEAKAGE @ 1500 VOLTS AC.
  - 3.4 INSULATION RESISTANCE: 1000 MEGOHMS MIN @ 25°C.
  - 3.5 MOISTURE RESISTANCE: IP67 ( MATED CONDITION )
  - 3.6 MATING CYCLE DURABILITY: 100 CYCLES
  - 3.7 RoHS COMPLIANT
4. MATING PART: AT06-08SX\* PLUG  
( X = A,B,C,D KEYS; \* = MODIFICATIONS AND COLORS )
5. ALL DIMENSIONS ARE FOR REFERENCE USE ONLY.

△ CONTACT SIZE AND REAR SEAL WIRE RANGE

REDUCED DIAMETER SEAL:

CONTACT SIZE	MIN. INSUL O.D.	MAX. INSUL O.D.	TYPICAL WIRE RANGE
16	1.35 mm (.053 in)	3.05 mm (.120 in)	14 - 20 AWG

STANDARD SEAL:

CONTACT SIZE	MIN. INSUL O.D.	MAX. INSUL O.D.	TYPICAL WIRE RANGE
16	2.24 mm (.088 in)	3.68 mm (.145 in)	14 - 20 AWG

REVISIONS					
REV	ECO	DESCRIPTION	DATE	BY	APPR
A1	-	RELEASE	29JUN15	JAH	
A2	-	UPDATE APPEARANCE	20APR16	JARRY	TOMMY
A3	-	ADDED -15 & -16 OPTIONS ADDED COLORS TO NOTE #1	23MAR18	JAH	

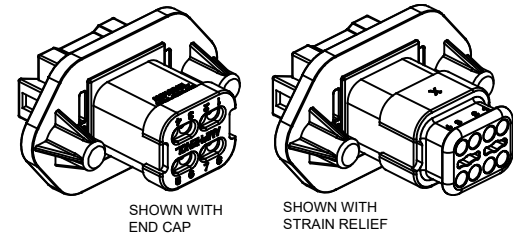

SEE SHEET 2 FOR KEYS					
PART NUMBER		DESCRIPTION		ITEM	
QUANTITY	MATERIALS LIST				
UNLESS OTHERWISE SPECIFIED		SIGNATURES		DATE	
1) All dimensions are in metric (mm).		DRAWN: J. HEAD		14JUL15	
2) Tolerances are as follows:		CHECKED:			
1 PL DEC ±0.30		ENGINEER:			
2 PL DEC ±0.15		APPROVAL:			
3 PL DEC ±0.08		CUSTOMER:			
3) Note reference = △		FRACTIONS ±1/64		Angles ±1°	
MATERIAL SPECIFICATIONS:		THIS DRAWING IS SUPPLIED FOR INFORMATION ONLY. DESIGN FEATURES, SPECIFICATIONS AND PERFORMANCE DATA SHOWN HEREON ARE THE PROPERTY OF THE AMPHENOL CORPORATION. NO RIGHTS OF REPRODUCTION ARE IMPLIED. ALL DIMENSIONS ARE SUBJECT TO NORMAL MANUFACTURING VARIATIONS.		<b>Amphenol</b> Sine Systems - www.amphenol-sine.com 44724 Morley Drive Clinton Township, MI 48036	
PROCESS SPECIFICATIONS:		RECEPTACLE, 8 PIN, AT SERIES, W/FLANGE		SIZE: B C- TYPE: AT04-08PX-PMXX DWG NO.: A3 REVISION:	
NEXT ASSY:		SCALE: NONE		SHEET 1 OF 2	

TITLE: RECEPTACLE, 8 PIN, AT SERIES, W/FLANGE  
DWG NO.: AT04-08PX-PMXX  
REV: A3  
SHEET 1 OF 2

REVISIONS					
REV	ECO	DESCRIPTION	DATE	BY	APPR
A1	-	RELEASE	14JUL15	JAH	
A2	-	UPDATE APPEARANCE	20APR16	JARRY	TOMMY
A3	-	ADDED -15 & -16 OPTIONS ADDED COLORS TO NOTE #1	23MAR18	JAH	

P/N AT04-08PA-PMXX  
KEY-A CONFIGURATION  
STANDARD HOUSING COLOR: GREY



KEY-A CONFIGURATION			
PART NUMBER	SEAL	END CAP	STRAIN RELIEF
AT04-08PA-PM11	STANDARD	NO	NO
AT04-08PA-PM12	REDUCED DIA.	NO	NO
AT04-08PA-PM13	STANDARD	YES	NO
AT04-08PA-PM14	REDUCED DIA.	YES	NO
AT04-08PA-PM15	STANDARD	NO	YES
AT04-08PA-PM16	REDUCED DIA.	NO	YES

P/N AT04-08PB-PMXX  
KEY-B CONFIGURATION  
STANDARD HOUSING COLOR: BLACK

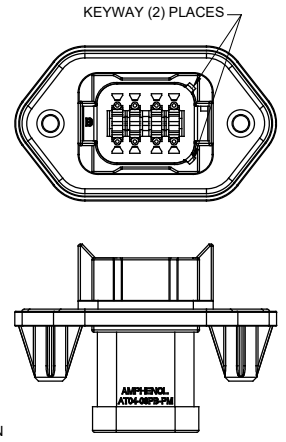

KEY-B CONFIGURATION			
PART NUMBER	SEAL	END CAP	STRAIN RELIEF
AT04-08PB-PM11	STANDARD	NO	NO
AT04-08PB-PM12	REDUCED DIA.	NO	NO
AT04-08PB-PM13	STANDARD	YES	NO
AT04-08PB-PM14	REDUCED DIA.	YES	NO
AT04-08PB-PM15	STANDARD	NO	YES
AT04-08PB-PM16	REDUCED DIA.	NO	YES

P/N AT04-08PC-PMXX  
KEY-C CONFIGURATION  
STANDARD HOUSING COLOR: GREEN

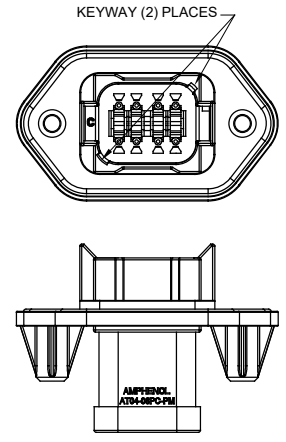

KEY-C CONFIGURATION			
PART NUMBER	SEAL	END CAP	STRAIN RELIEF
AT04-08PC-PM11	STANDARD	NO	NO
AT04-08PC-PM12	REDUCED DIA.	NO	NO
AT04-08PC-PM13	STANDARD	YES	NO
AT04-08PC-PM14	REDUCED DIA.	YES	NO
AT04-08PC-PM15	STANDARD	NO	YES
AT04-08PC-PM16	REDUCED DIA.	NO	YES

P/N AT04-08PD-PMXX  
KEY-D CONFIGURATION  
STANDARD HOUSING COLOR: BROWN

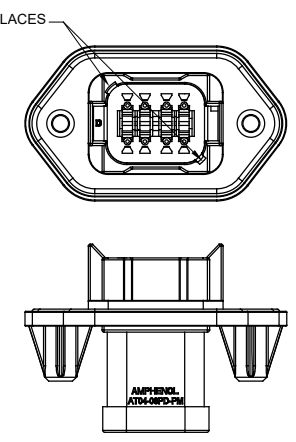

KEY-D CONFIGURATION			
PART NUMBER	SEAL	END CAP	STRAIN RELIEF
AT04-08PD-PM11	STANDARD	NO	NO
AT04-08PD-PM12	REDUCED DIA.	NO	NO
AT04-08PD-PM13	STANDARD	YES	NO
AT04-08PD-PM14	REDUCED DIA.	YES	NO
AT04-08PD-PM15	STANDARD	NO	YES
AT04-08PD-PM16	REDUCED DIA.	NO	YES

QUANTITY	PART NUMBER	DESCRIPTION	ITEM
<b>MATERIALS LIST</b>			
<small>UNLESS OTHERWISE SPECIFIED</small> 1) All dimensions are in metric (mm). 2) Tolerances are as follows: 1 PL DEC ±0.30    Fractions ±1/64 2 PL DEC ±0.15    Angles ±1° 3 PL DEC ±0.08 3) Note reference =		SIGNATURES    DATE DRAWN: J.HEAD    14JUL15 CHECKED: ENGINEER: APPROVAL: CUSTOMER:	 Sine Systems - www.amphenol-sine.com 44724 Morley Drive Clinton Township, MI 48036 <b>RECEPTACLE, 8 PIN, AT SERIES, W/FLANGE</b>
MATERIAL SPECIFICATIONS: PROCESS SPECIFICATIONS: NEXT ASSY:		THIS DRAWING IS SUPPLIED FOR INFORMATION ONLY. DESIGN FEATURES, SPECIFICATIONS AND PERFORMANCE DATA SHOWN HEREON ARE THE PROPERTY OF THE AMPHENOL CORPORATION. NO RIGHTS OF REPRODUCTION ARE IMPLIED. ALL DIMENSIONS ARE SUBJECT TO NORMAL MANUFACTURING VARIATIONS.	
SIZE: <b>B C-</b> TYPE: <b>AT04-08PX-PMXX</b> DWG NO: <b>A3</b> REVISION: <b>A3</b>		SCALE: <b>NONE</b> SHEET <b>2</b> OF <b>2</b>	

TITLE: RECEPTACLE, 8 PIN, AT SERIES, W/FLANGE  
 DWG NO: AT04-08PX-PMXX  
 REV: A3  
 SH: 2  
 OF: 2

# A Series™ - Contact Size 16 Options (Works with: AT, ATV, AHD-9, ARC, DuraMate and PanelMate Series)

Machined Contacts, Sockets & Pins				
Part Number	Description	Size	AWG	Type
AT60-215-1631	Male Contact - Pin, Gold-plated	16	14	Machined
AT62-209-1631	Female Contact - Socket, Gold-plated	16	14	Machined
AT60-215-16141	Male Contact - Pin, Nickel-plated	16	14	Machined
AT62-209-16141	Female Contact - Socket, Nickel-plated	16	14	Machined
AT60-202-1631	Male Contact - Pin, Gold-plated	16	16-20	Machined
AT62-201-1631	Female Contact - Socket, Gold-plated	16	16-20	Machined
AT60-202-16141	Male Contact - Pin, Nickel-plated	16	16-20	Machined
AT62-201-16141	Female Contact - Socket, Nickel-plated	16	16-20	Machined
AT60-202-1631-22	Male Contact - Pin, Gold-plated	16	22-24	Machined
AT62-201-1631-22	Female Contact - Socket, Gold-plated	16	22-24	Machined
AT60-202-16141-22	Male Contact - Pin, Nickel-plated	16	22-24	Machined
AT62-201-16141-22	Female Contact - Socket, Nickel-plated	16	22-24	Machined

Tooling - Machined Contacts	
Part Number	Description
AUTK-20	Hand Crimp Tool, Size 20
AUTK-100	Universal Heavy Duty Contact Crimping Tool Kit, Size 12/16/20
CA-5D12	Universal Hand Crimp Tool, Size 12/16/20
CA-5E12	Pneumatic Crimp Tool, Size 12/16/20

Contact Removal Tools (For both Machined or Stamped & Formed Contacts)	
Part Number	Description
ATRT-100	Contact and Wedgelock Extraction Tool
AT11-310-1605	Contact Removal Tool, Plastic, Size 16

Sealing Plugs (For both Machined or Stamped & Formed Contacts)	
Part Number	Description
A114017	Sealing Plug, Size 16, White
A114017-SR	Sealing Plug, Size 16, SR01 Series, Black
AT13-217-1605	Locking Sealing Plug, Size 16, Grey
AT13-217-1605-SR	Locking Sealing Plug, Size 16, SR01 Series, Red

Stamped & Formed Contacts, Sockets & Pins				
Part Number	Description	Size	AWG	Type
AT60-14-0144	Male Contact - Pin, Gold-plated	16	14-16	Stamped & Formed
AT62-14-0144	Female Contact - Socket, Gold-plated	16	14-16	Stamped & Formed
AT60-14-0122	Male Contact - Pin, Nickel-plated	16	14-16	Stamped & Formed
AT62-14-0122	Female Contact - Socket, Nickel-plated	16	14-16	Stamped & Formed
AT60-16-0144	Male Contact - Pin, Gold-plated	16	16-18	Stamped & Formed
AT62-16-0144	Female Contact - Socket, Gold-plated	16	16-18	Stamped & Formed
AT60-16-0122	Male Contact - Pin, Nickel-plated	16	16-18	Stamped & Formed
AT62-16-0122	Female Contact - Socket, Nickel-plated	16	16-18	Stamped & Formed
AT60-16-0644	Male Contact - Pin, Gold-plated	16	18-20	Stamped & Formed
AT62-16-0644	Female Contact - Socket, Gold-plated	16	18-20	Stamped & Formed
AT60-16-0622	Male Contact - Pin, Nickel-plated	16	18-20	Stamped & Formed
AT62-16-0622	Female Contact - Socket, Nickel-plated	16	18-20	Stamped & Formed
AT60-16-0844	Male Contact - Pin, Gold-plated	16	20-22	Stamped & Formed
AT62-16-0844	Female Contact - Socket, Gold-plated	16	20-22	Stamped & Formed
AT60-16-0822	Male Contact - Pin, Nickel-plated	16	20-22	Stamped & Formed
AT62-16-0822	Female Contact - Socket, Nickel-plated	16	20-22	Stamped & Formed

Tooling - Stamped & Formed Contacts	
MFX-3950	Crimp Die - Size 16, 18-20AWG
MFX-3953	Crimp Die - Size 16, 16-18AWG
MFX-3975	Crimp Die - Size 16, 14-16AWG
MFX-3990	Crimp Die - Size 16, 20-22AWG
ATT-16-00	Hand Crimp Tool - Size 16, 14-16AWG
ATT-16-01	Hand Crimp Tool - Size 16, 18-20AWG
ATT-1612-03	Hand Crimp Tool - Size 16, 20-22AWG