

Solid State Relay

ASR-SJ Series Single Phase DC Output



- MOSFET or IGBT Output
- Low Impedance
- 4-32VDC Control Input
- Load Current: 7A-100A
- Dielectric Strength: 2500Vrms
- Internal Over-voltage Protection
- LED Indicator
- RoHS Compliant

ASR	-	SJ	50	D	40	W	-L
	Packing -: Bulk A-Z	ASR- SJ Series	Load Voltage 30: 30VDC 50: 50VDC 60: 60VDC 100:100VDC 200: 200VDC 400: 400VDC 600: 600VDC 1200:1200VDC	Control Voltage D:DC Control	Load Current 7: 7 Amp 10: 10 Amp 20: 20 Amp 25: 25 Amp 40: 40 Amp 50: 50 Amp 80: 80 Amp 100:100 Amp	Control Voltage W: 4-32VDC	LED Indication Blank: Without LED L: With LED

NOTE: PART NUMBERS ARE AS FOLLOWS

	30VDC	50VDC	60VDC	100VDC	200VDC	400VDC	600VDC	1200VDC
7A			ASR-SJ60D7W-L					
10A					ASR-SJ200D10W-L			
20A				ASR-SJ100D20W-L	ASR-SJ200D20W-L			
25A						ASR-SJ400D25W-L	ASR-SJ600D25W-L	ASR-SJ1200D25W-L
40A		ASR-SJ50D40W-L		ASR-SJ100D40W-L	ASR-SJ200D40W-L			
50A	ASR-SJ30D50W-L		ASR-SJ60D50W-L				ASR-SJ600D50W-L	ASR-SJ1200D50W-L
80A		ASR-SJ50D80W-						
100A	ASR-SJ30D100W-L			ASR-SJ100D80W-L				

Solid State Relay

ASR-SJ Series Single Phase DC Output

Technical Specification

INPUT CIRCUIT (TA=25°C)		
Control Voltage Range		4-32VDC
Must Turn-On Voltage		4VDC
Must Turn-Off Voltage		1VDC
Maximum Input Current		25mA@32VDC
Maximum Transient Overvoltage		32VDC
OUTPUT CIRCUIT (TA=25°C)		
Load Voltage Range	ASR-SJ30	0-24VDC
	ASR-SJ50	0-36VDC
	ASR-SJ60	0-48VDC
	ASR-SJ100	0-75VDC
	ASR-SJ200	0-120VDC
	ASR-SJ400	0-300VDC
	ASR-SJ600	0-500VDC
	ASR-SJ1200	0-650VDC
Maximum Load Current (A)	ASR-SJ30	50/100A
	ASR-SJ50	40/80A
	ASR-SJ60	7/50A
	ASR-SJ100	20/40/80/100A
	ASR-SJ200	10/20/40A
	ASR-SJ400	25A
	ASR-SJ600	25/50A
	ASR-SJ1200	25/50A

Solid State Relay

ASR-SJ Series Single Phase DC Output

Maximum Surge Current (Apk@10ms)	ASR-SJ30	150@50Amps
		250@100Amps
	ASR-SJ50	120@40Amps
		200@80Amps
	ASR-SJ60	30@7Amps
		150@50Amps
	ASR-SJ100	60@20Amps
		20@40Amps
		200@80Amps
		250@100Amps
	ASR-SJ200	30@10Amps
		60@20Amps
		120@40Amps
	ASR-SJ400	150@25Amps
	ASR-SJ600	2150@25Amps
		300@50Amps
	ASR-SJ1200	150@25Amps
		300@50Amps
	ASR-SJ30	4.7@50Amps
		2.1@100Amps
	ASR-SJ50	12@40Amps
		6@80Amps
	ASR-SJ60	14@7Amps
		7@50Amps
ASR-SJ100	13@20Amps	
	13@40Amps	
	6.5@80Amps	
	6.5@100Amps	
ASR-SJ200	60@10Amps	
	30@20Amps	
	30@40Amps	

Solid State Relay

ASR-SJ Series Single Phase DC Output

Maximum On State Voltage Drop @ Rated Current (V)	ASR-SJ400/ 600/1200	1.75V
Maximum On State Leakage Current @ Load Voltage (mA)	ASR-SJ100/200	0.1mA
	ASR-SJ400/ 600/1200	0.5mA
Minimum Load Current (mA)		2mA
Maximum Turn-On Time (ms)	ASR-SJ100/200	0.1ms
	ASR-SJ400/ 600/1200	1ms
Maximum Turn-Off Time (ms)	ASR-SJ100/200	0.1ms
	ASR-SJ400/ 600/1200	1ms
OUTPUT CIRCUIT (TA=25°C)		
Dielectric Strength, Input/Output (50/60Hz)		2500Vrms
Minimum Insulation Resistance(@500VDC)		1000MΩ
Ambient Temperature Range		-30°C +80°C
Storage Temperature Range		-30°C +100°C
Weight (typical)		100g

Application Note:

Control heating, DC power supplies, electromechanical valves, motors, medical equipment, etc.

Outline Dimensions/ Wiring Diagram

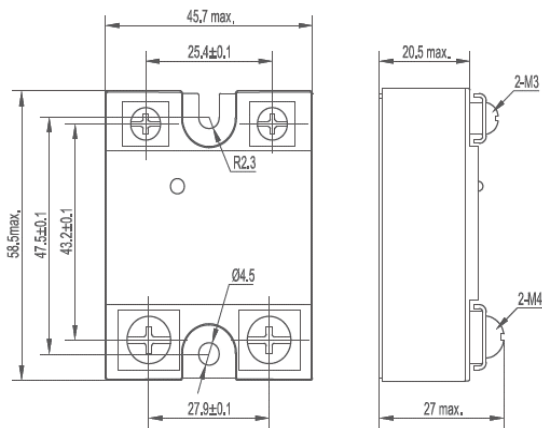

Outline Dimensions

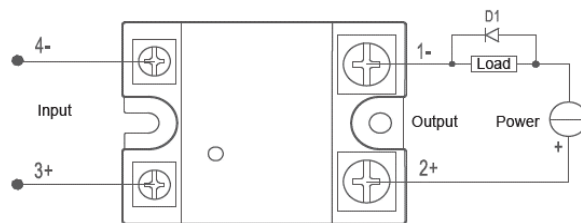

When the relay is used for inductive load control, please be sure to use a suppression circuit, just like the drawing above. Both load terminals are inverse paralleled with a fly-wheel diode D1.
D1: Fast Recovery Diode

Wiring Diagram

Solid State Relay

ASR-SJ Series Single Phase DC Output

Thermal Curve

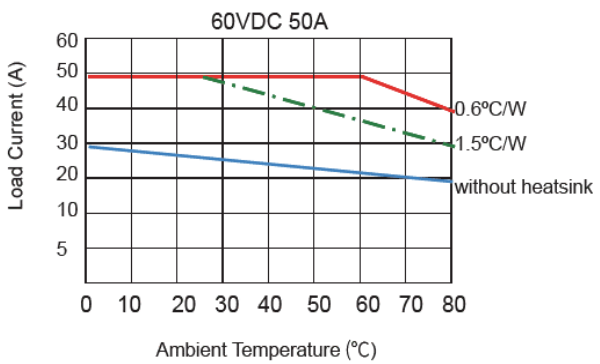
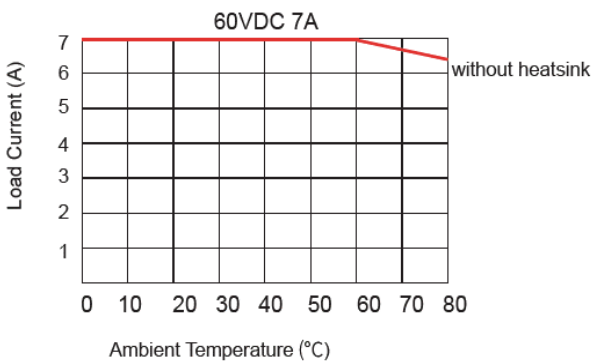
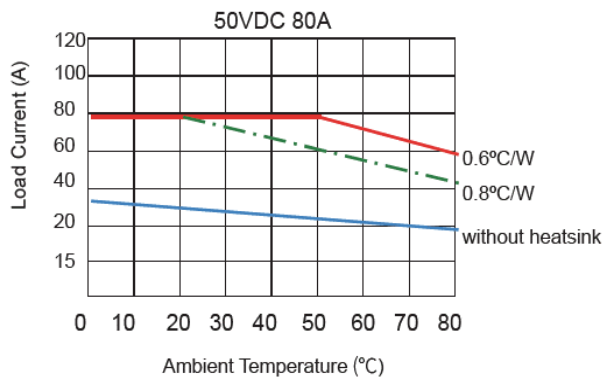
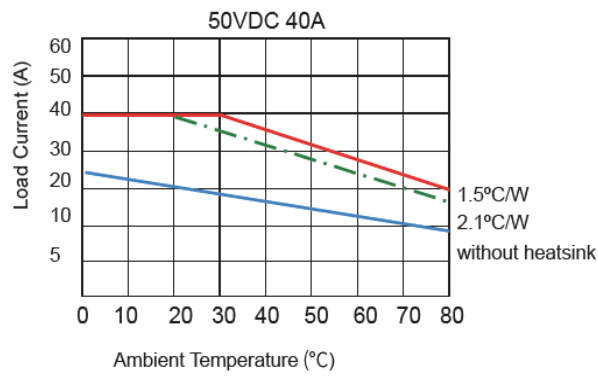
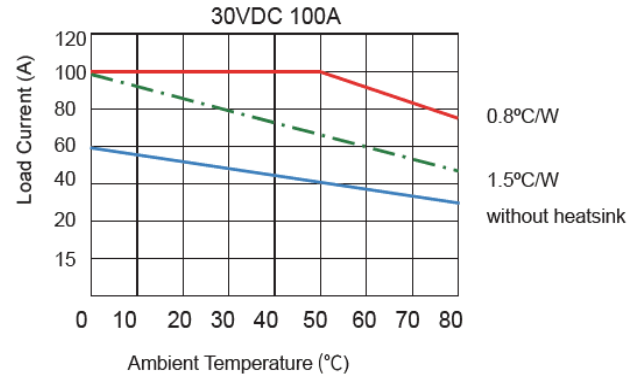
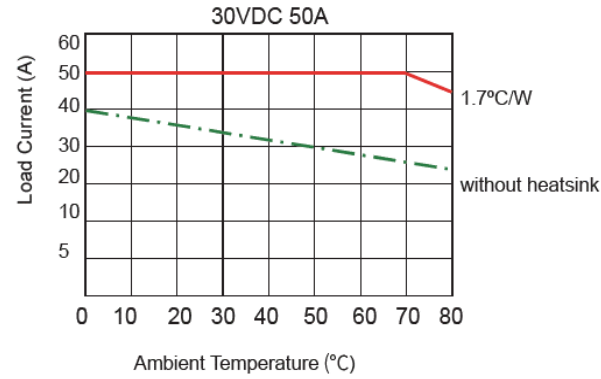

Solid State Relay

ASR-SJ Series Single Phase DC Output

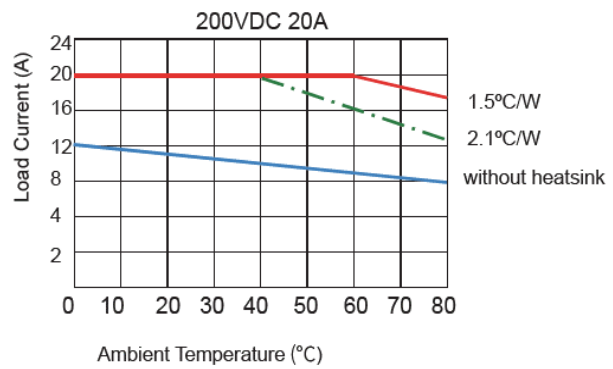
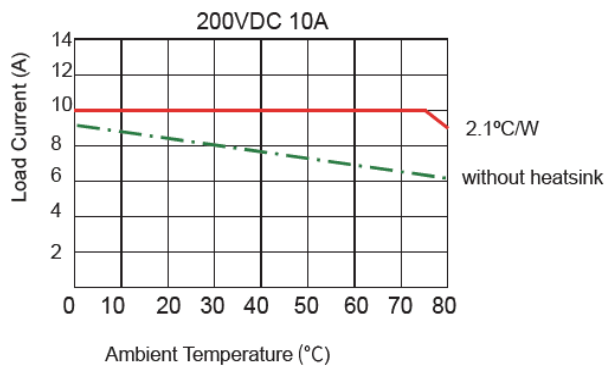
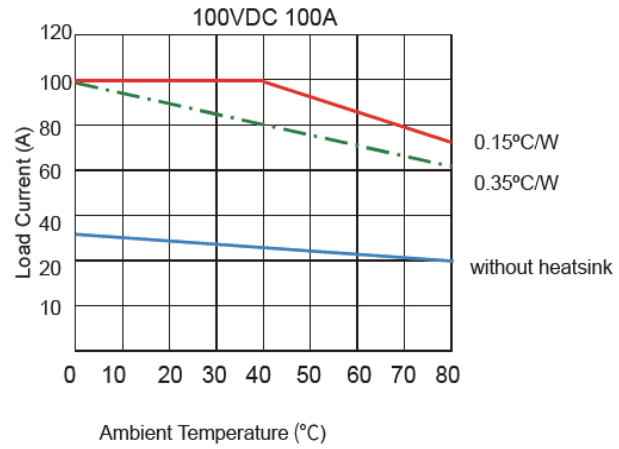
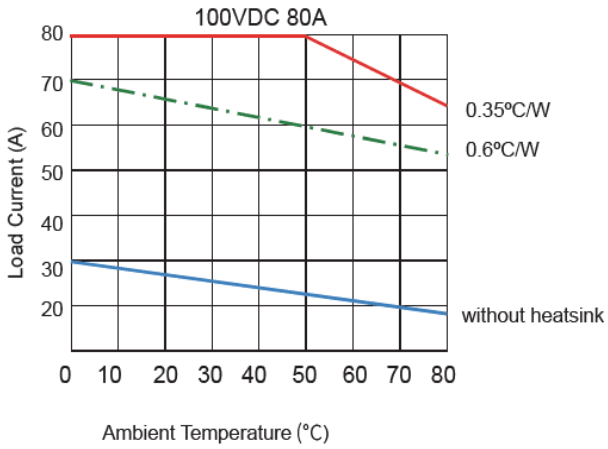
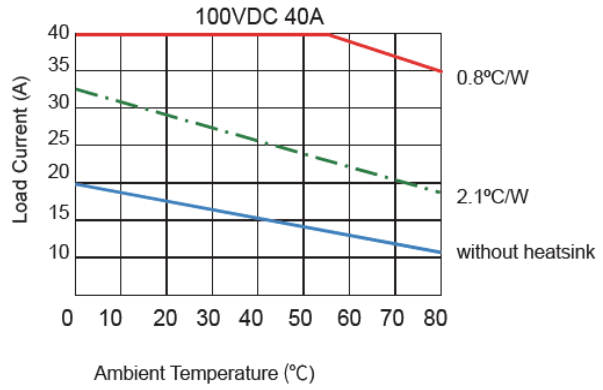
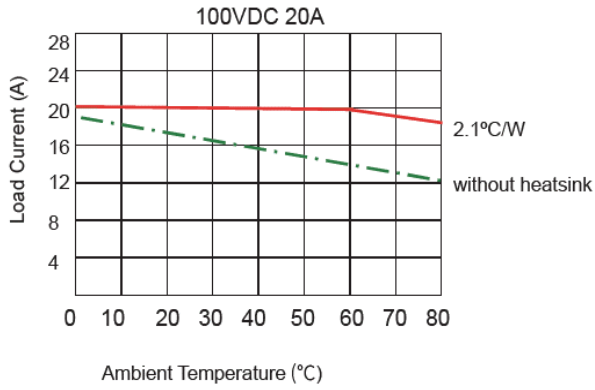

Solid State Relay

ASR-SJ Series Single Phase DC Output

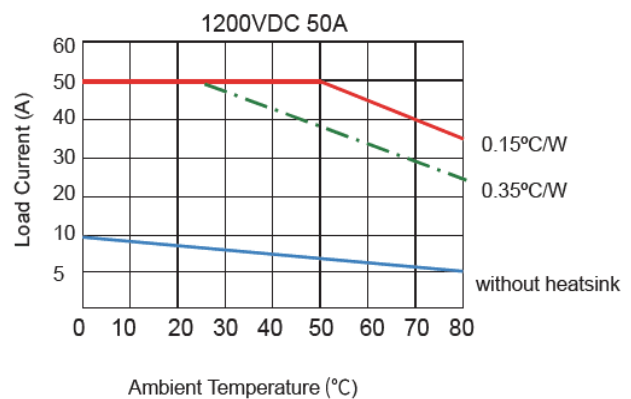
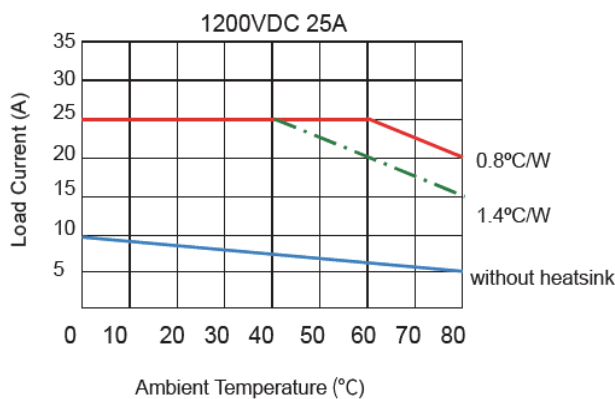
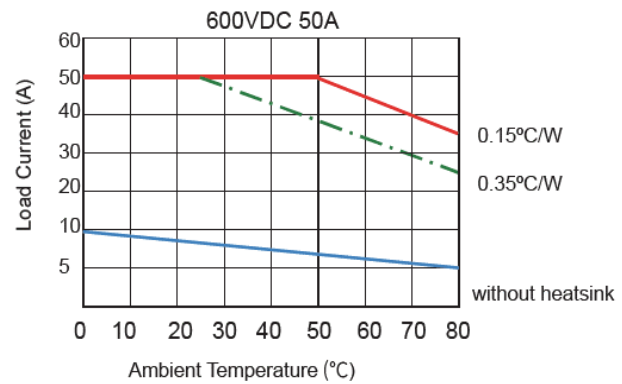
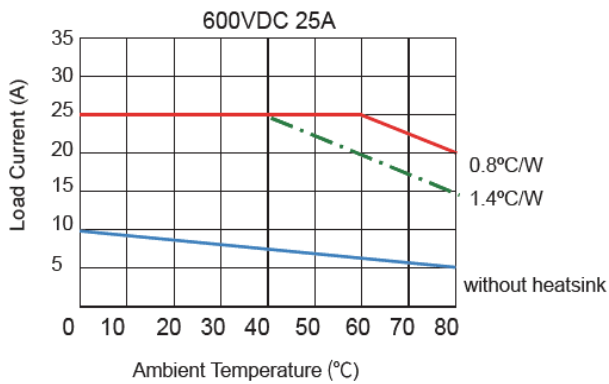
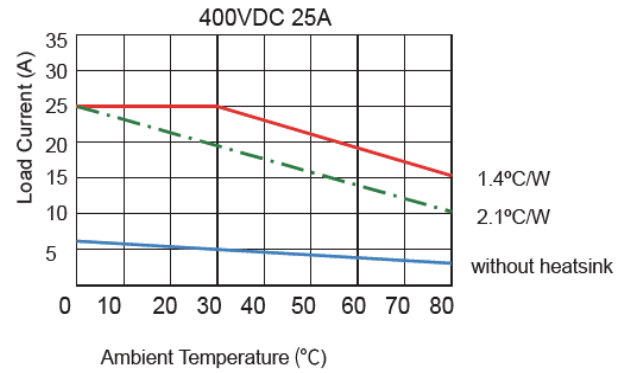
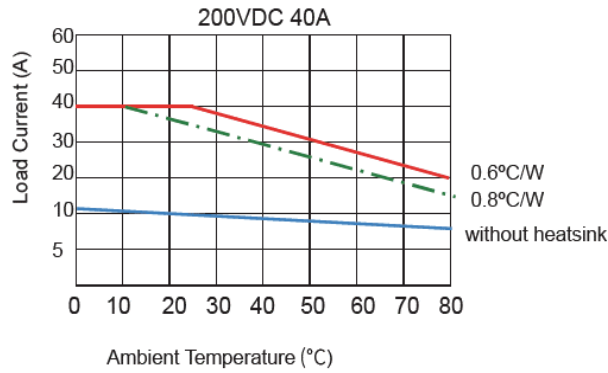

Important Notice

1. Relay must be mounted to proper sized heat sink based on thermal curves. Thermal grease or a thermal pad must be used between relay and heat sink and be torqued down to 18-20/2.0-2.2in-lb/Nm.
2. When connection wiring to SSR please ensure screws are torqued down properly (input 13-15/1.5in-lb/Nm, output 18-20/2.0-2.2in-lb/Nm.)
3. When Ambient temperature is above 25°C see thermal derating curve.

1741 Industrial Drive, No. 14 • Sterling, IL 61081
 Tel: 815-632-3150 • Fax: 815-632-3449
 www.altranmagnetics.com • sales@altranmagnetics.com

