

# ASF1400

## Bidirectional Mass Flow Meter

- \_ Unique dynamic range:  
0.01 sccm – 400 sccm
- \_ Outstanding resolution and accuracy
- \_ Ultra fast response time
- \_ Hysteresis & offset free
- \_ Calibrated & temperature compensated
- \_ RS-232 and



Version 2.2 / November

### ASF1400 Product Summary

The ASF1400 Mass Flow Meter enables extremely accurate bidirectional measurement of gas flow over four orders of magnitude. Its leading performance is based on SENSIRION's unsurpassed CMOSens<sup>®</sup> sensor technology. With CMOSens<sup>®</sup>, the on-chip sensor element forms an integrated whole with the amplification and A/D converter circuit. This results in superior resolution, fast response time and large dynamic range at lowest power consumption.

All measurement data is fully calibrated and temperature compensated by means of an internal microcontroller.

Mounted in rugged, chemically inert PBT housing the ASF1400 is suitable for a wide range of applications. Such include mass flow metering for process control, medical applications, heating ventilation and air conditioning (HVAC) solutions, as well as gas flow metrology.

The sensor housing provides two inlets for measuring the gas flow and withstands overpressures of 2 bar (29 psi).

The ASF1400 requires a supply voltage of 7...18Vdc and provides an RS-232 compliant electrical interface.

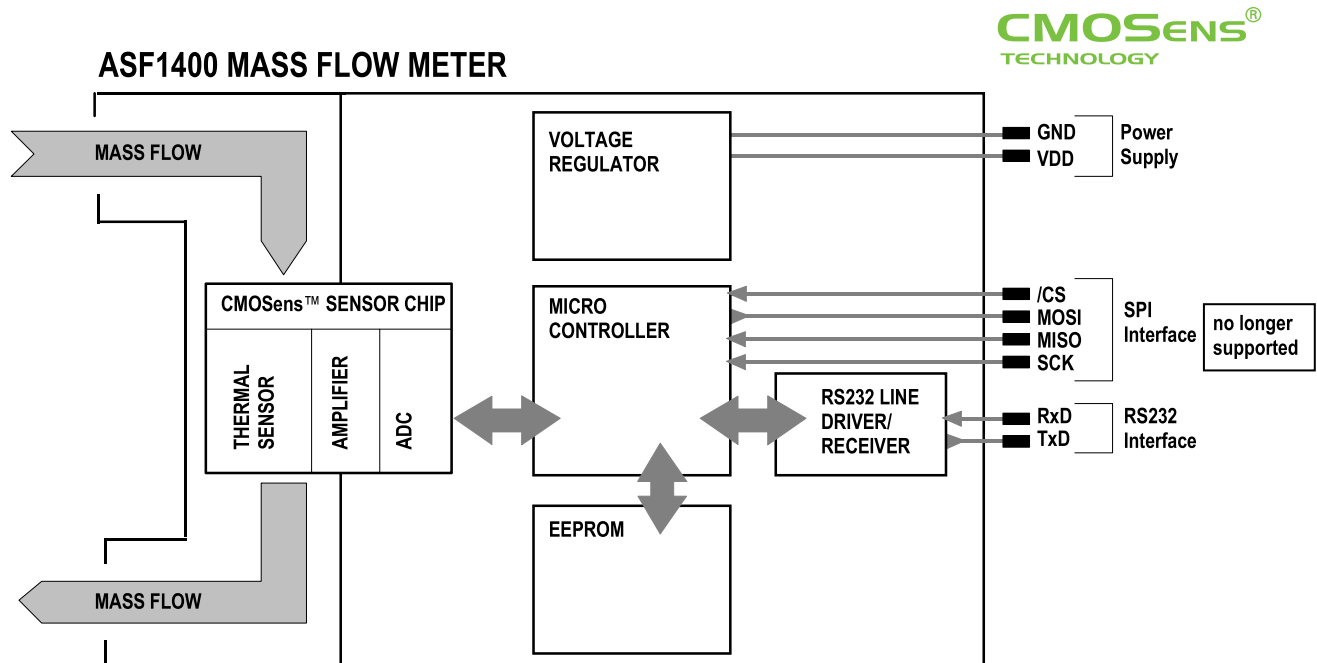

Figure 1: Block Diagram ASF1400 Mass Flow Sensor with CMOSens<sup>®</sup> technology.

## Introductory Description

The heart of the ASF1400 mass flow meter is powered by Sensirion's unsurpassed CMOSens<sup>®</sup> sensor technology. The ASF1400 mass flow meter therefore provides unbeatable performance at very attractive system cost. The lowest detectable gas flow rate is 0.003 sccm, which means a minimum volume of 3 mm<sup>3</sup> gas per minute can be measured. Covering at the same time a flow range of more than 4 orders of magnitude, the ASF1400 sets a new standard wherever mass flow has to be measured or controlled.

The ASF1400 device measures true mass flow independent of the ambient temperature and pressure changes. You simply connect the gas to be measured to the ASF1400 device to get an instantaneous gas flow rate at a sampling rate of up to 7Hz (please contact us for sampling rates of up to 200Hz).

A flow range between  $\pm 400$  sccm can directly be measured by connecting the ASF1400. To increase the range, a bypass can be used in conjunction with the ASF1400 device (see Section 1.4 of this data sheet).

In addition to mass flow, the ASF1400 device provides information about the temperature on the CMOSens<sup>®</sup> sensor element. Both mass flow and temperature data are accessed through an RS-232. The RS-232 interface allows you to directly connect the ASF1400 device to a PC or PDA using standard terminal software. If a special interface such as 4-20 mA current output or other is required contact Sensirion for a customer specific solution.

In general, all gas types can be measured using the ASF1400 product. However, the standard calibration

gas is nitrogen. Please contact SENSIRION, if you would like to use the sensor for applications with other gases.

To get you started quickly, an evaluation package including ASF1400 devices, software, cables, rubber hose and bypass is available from Sensirion AG.

## CMOSens<sup>®</sup> sensor technology

CMOSens<sup>®</sup> is the base technology for all Sensirion multi sensor modules and sensor systems. The unification of semiconductor chip and sensor technology serves as a platform for highly integrated system solutions with excellent sensor precision and reliability. With CMOSens<sup>®</sup>, the on-chip sensor element forms an integrated whole with a high-end amplification and A/D converter circuit. Due to the compact single-chip design, CMOSens<sup>®</sup> based sensors are very resistant to electromagnetic disturbances (EMC), another important technical advantage of this state of the art sensor technology. As a result, CMOSens<sup>®</sup> based multi sensor modules offer excellent sensor precision, fast response time and a very large dynamic measurement range. In addition, the digital intelligence of the CMOSens<sup>®</sup> sensor technology enables digital interfaces that permit an easy link with the system of the customer, a real advantage and benefit that results in ready-to-use problem solutions ("Mount&Sense").

## 1 Mass Flow Sensor Performance

Table 1: Overview of ASF1400 Gas Sensor Performance<sup>1</sup>

Parameter	Condition	Minimum	Typical	Maximum	Units
<b>Flow Sensor</b>					
Dynamic Range	direct measurement	-400		400	sccm <sup>(2)</sup>
	using proposed bypass tube <sup>(23)</sup>	-100		100	liter/min <sup>(4)</sup>
	customized bypass tube	unlimited		unlimited	
Resolution	400 sccm flow		0.09		sccm
	< 10 sccm flow		0.01		sccm
Lowest Detectable Flow	< 10 sccm flow		0.015 <sup>(4)</sup>		sccm
Pressure Drop	400 sccm, p <sub>abs.</sub> = 1 bar		120		Pa <sup>(5)</sup>
Repeatability			0.0025 % FS <sup>(6)</sup> 0.025 % m.v.		
Accuracy	23 °C	0...5 % of full scale	0.05 % FS <sup>(7)</sup>		
		5...100 % of full scale	1 % m.v. <sup>(7)</sup>		
Offset	23 °C		< 0.005	< 0.02	% FS
Overpressure Resistance <sup>(8)</sup>				2	bar
Response Time <sup>(9)</sup>	depends on resolution setting (see Section 3, Table 2)	142		1280	ms
Operating Temperature		0		70	°C
Ambient Temperature Coefficient	Zero		< 0.005		% FS / °C
	Span		< 0.08		% measured value / °C
Position Sensitivity	p <sub>abs.</sub> =1 bar, small nitrogen flow		±0.008		% FS
<b>Temperature Sensor</b>	Measures temperature inside the sensor, but not of the surrounding air <sup>(10/10)</sup>				
Dynamic Range		0		70	°C
Resolution			0.1		°C
Accuracy		3	2		°C

<sup>1</sup> All data apply for calibration conditions (20°C, 1013 mbar) unless otherwise noted.

<sup>2</sup> 1 sccm = 1 cm<sup>3</sup>/min at 0°C and 1013mbar pressure (1sccm = 0.001 norm liter)

<sup>3</sup> using bypass tube included in Sensirion's mass flow meter evaluation kit EK-F1

<sup>4</sup> 1 liter/min = 1000 sccm

<sup>5</sup> 1 bar = 100 000 Pa = 0.9869 atm = 401.9 inch H<sub>2</sub>O = 14.5 psi

<sup>6</sup> Error = % of full scale (FS) or % of measured value, whichever is bigger.

<sup>7</sup> Better calibration available for high volume OEM on request. Allow the Sensor to warm up for best results.

<sup>8</sup> For higher overpressure resistance versions please check the EM1 product page.

<sup>9</sup> For faster response times please check out the ASF1430 high speed mass flow meter data sheet

<sup>10</sup> The sensor warms up by about 7°C (depending on supply voltage and ventilation).

### 1.1 Gas Flow Characteristics

Figure 2 shows the applied gas flow vs. the digital output of the ASF1400.

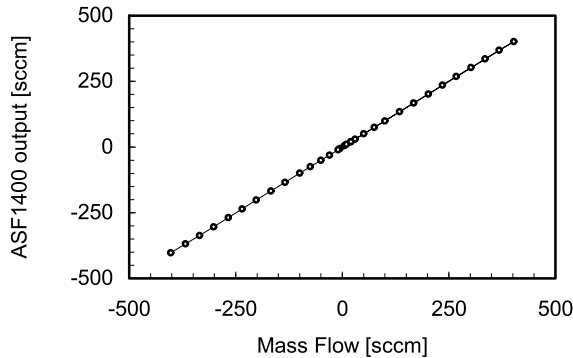

Figure 2: ASF1400 transfer characteristics.

### 1.2 Sensor Principle and Gas Types

The ASF1400 device detects mass gas flow by measuring heat transfer. A heating resistor on a thermally insulated membrane is kept above ambient temperature. In the presence of gas flow, the temperature distribution up- and downstream is disturbed. This asymmetry is then measured. Due to the minimal thermal mass of the membrane, symmetrical arrangement, and accurate temperature measurement, the revolutionary specifications of the ASF1400 devices are achieved.

The above mentioned thermal principle requires information about the gas type to be measured. The ASF1400 is available for air and nitrogen. Other gas types are available on request.

In Figure 3 the repeatability of the ASF1400 devices is compared with the repeatability of a typical Mass Flow Controller (MFC). It emphasizes the superior performance of the ASF1400 device.

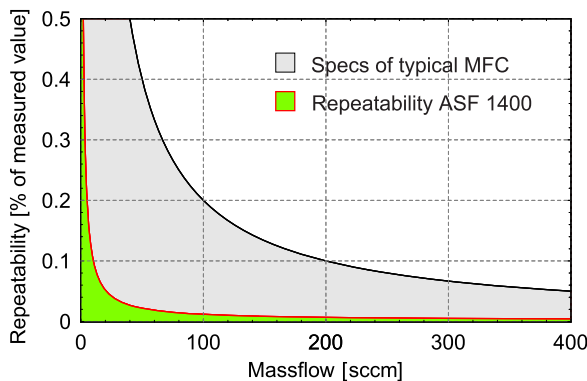

Figure 3: Comparison of the repeatability of the CMOSens® ASF1400 device compared to a typical Mass Flow Controller (MFC).

### 1.3 Gas Flow and Pressure Difference

The ASF1400 is calibrated for mass flow measurements. However, there is a well defined relation between mass flow and pressure drop. This relation is shown in Figure 4. On request the ASF1400 can also be calibrated for the pressure drop at its output (for more details refer to the documentation of the Sensirion Differential Pressure Sensor ASP1400).

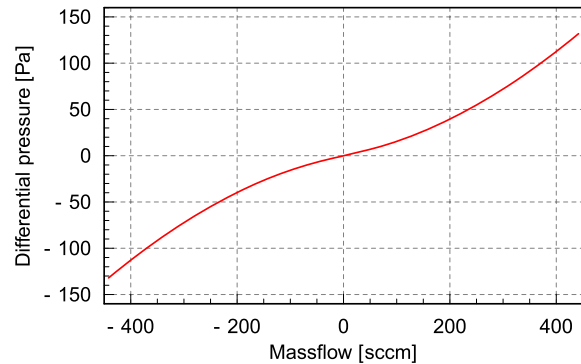

Figure 4: Differential Pressure vs. Mass Flow of ASF1400 Device.

### 1.4 Adjusting the Measurement Range

To adjust the measurement range, the ASF1400 device is used in conjunction with a bypass configuration (see Figure 5). Only a sample of the total flow actually gets directed through the bypass channel and the sensor system. A tube with flow restrictor and all required connection items are included in the Mass Flow Meter Evaluation Kit EK-F1, also available from SENSIRION AG.

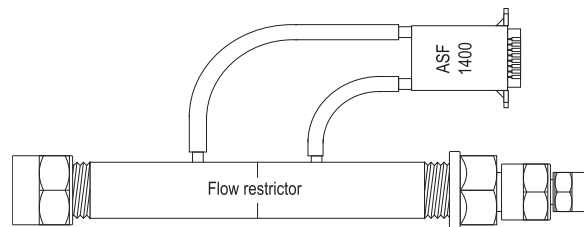

Figure 5: Extending the measurement range of the ASF1400 device using a bypass configuration. Only a sample of the total flow actually gets directed through the bypass channel and the sensor. Shown tube with flow restrictor is included in the EK-F1 evaluation kit.

## 2 Pins and Digital Interface

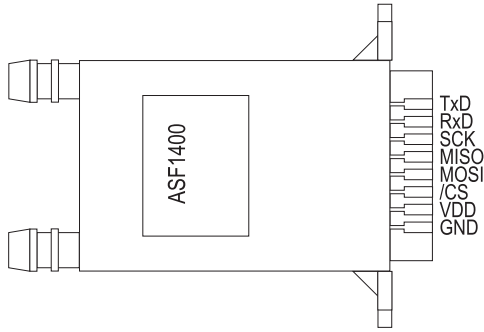

Figure 6: ASF1400 pin out.

### GND and VDD (Power Supply)

The ASF1400 requires a voltage supply of between 7 V and 18 V. Since this voltage is internally regulated, there are no stringent requirements as far as ripple and stability are concerned.

### 2.1 Connector

You need an EDAC 395-010-520-102 connector to connect the sensor. Please check the EDAC homepage for details ([www.edac.net](http://www.edac.net)).

Alternatively the AVX 00 6338 020 000 04 0 or AVX 00 6338 020 000 04 2 connectors can be used to connect the ASP1400 as well. (See [www.farnell.com](http://www.farnell.com), order codes 635789 or 635730).

### 2.2 RS-232 Interface

All configurations (see also Section 3) for the ASF1400 can be set using its RS-232 interface). To communicate with the ASF1400 via RS-232 the following pins are required:

**RxD (Receiving Data Line)**  
**TxD (Transmitting Data Line)**  
**GND (Ground)**

The RS-232 of the ASF1400 is configured as follows:

Baudrate	9600
Data Bits	8
Stop Bits	1
Parity	none
Protocol	none

With these settings, the ASF1400 device can be connected to any PC or PDA equipped with terminal software.

The measurement values are provided as a signed floating point number together with the corresponding unit (**sccm** for mass flow, **C** for temperature). In case of an overflow, the output shows **oF**.

### 2.3 Serial Peripheral Interface (SPI)

The in earlier versions available SPI interface is due to changes in electronic components no longer supported.

## 3 Configuration and Commands

The ASF1400 device accepts a set of commands through its RS-232 interface (see table 3 for valid commands; for correct settings of the RS-232 refer to Section 2.1). This allows the user to configure the ASF1400 device. Since the configuration is stored in the internal EEPROM, it is maintained after power breaks.

With the exception of the stop **s** command, all commands have to be terminated by the return key (↵, ASCII #10 or #13). After completion of a command, the ASF1400 returns **ok** and is ready to take a new instruction. Before entering a command, it may be necessary to clear the buffer by means of using ↵.

There is a trade-off between resolution and measurement time. Possible settings are listed in Table 2. Choosing 12 bit results in a measurement interval of 142 ms. With the max resolution of 15.2 bit, a new measurement is provided every 1280 ms. For faster sampling rates refer to the ASF1430 high speed mass flow meter device data sheet.

Table 2: Resolution settings using the **res=value** command and corresponding response times

res=	Resolution [bit]	data interval [ms]
1	12.0	142
2	13.0	284
3	13.5	427
4	14.0	569
5	14.3	711
6	14.6	853
7	14.8	995
8	15.0	1138
9	15.2	1280

Table 3: Commands of the ASF1400 device.

Command	Output	Description
help↵	commands	Lists all available commands

ver.↓	version	Provides type of sensor, software, hardware and customer version
get.↓		Start single measurement
go.↓		Starts series of measurements
s	stop	Stops series of measurements
reset.↓		Resets ASF1400 device
res=1..9↓	resolution	Sets resolution: 1 -> 12 bits; 9 -> 15 bits, see Table 2
res?	resolution	Shows actual setting
mod=F   T.↓	mode	Selects Flow- (F) or Temperature mode (T)
mod?	mode	Shows actual setting
Disp=s,d	display mode	Shows Flow (s) or Flow+Temperature (d) *no effect in the Temperature mode
Disp?	display mode	Shows actual setting
defspi=P   G.↓	define spi	Sets SPI in Push- (P) or Get mode (G), see also Section 4.3

## Notes:

- Default settings are marked in **bold** letters
- The commands are not case sensitive.
- In order to send a new command to the ASF1400 make sure the ASF1400 is not in measurement mode. Issue therefore a stop command **s** first. After this, any instruction can be given to the ASF1400 and a new series of measurement can be started by **go.↓**.
- Due to the limited write cycles allowed for the EEPROM, excessive configuration modifications should be avoided.

## 4 Specifications ASF1400

### 4.1 Absolute Maximum Ratings

Ambient storage temperature	-65°C to 150°C
Ambient operating temperature	0°C to 70°C
Overpressure resistance	2.0 bar

### 4.2 Electrical Specifications

Table 3: ASF1400 DC Characteristics.

Parameter	Conditions	Min.	Typ.	Max.	Units
Power Supply DC	DC	7	9	18	V
Operating Current	VDD = 9 V, no load		20		mA
	VDD = 9 V, 3kΩ at RS232 output		27		mA
Power Dissipation	VDD = 9 V, no load		180		mW

Table 4: ASF1400 RS-232 Characteristics.

Parameter	Conditions	Min.	Typ.	Max.	Units
<b>RS232 Output</b>					
Output Voltage Swing	Transmitter output loaded with 3kΩ	±5	±9		V
Power-Off Output Resistance		300			Ω
Output Short Circuit Current			±18		mA
<b>RS-232 Input</b>					
Voltage Range		-15		15	V
Voltage Threshold					
Low		0.8	1.2		V
High			1.7	2.4	V
Hysteresis		0.2	0.5	1.0	V
Resistance		3	5	7	kΩ

## 5 Physical Dimensions and Mounting Information

The ASF1400 is mounted in chemically inert PBT housing. The rugged package has been designed to withstand overpressures of up to 2 bars. Higher pressure packages of up to 10 bars are available on request.

Physical dimensions and mounting information are provided in Figure 11 and Table 6.

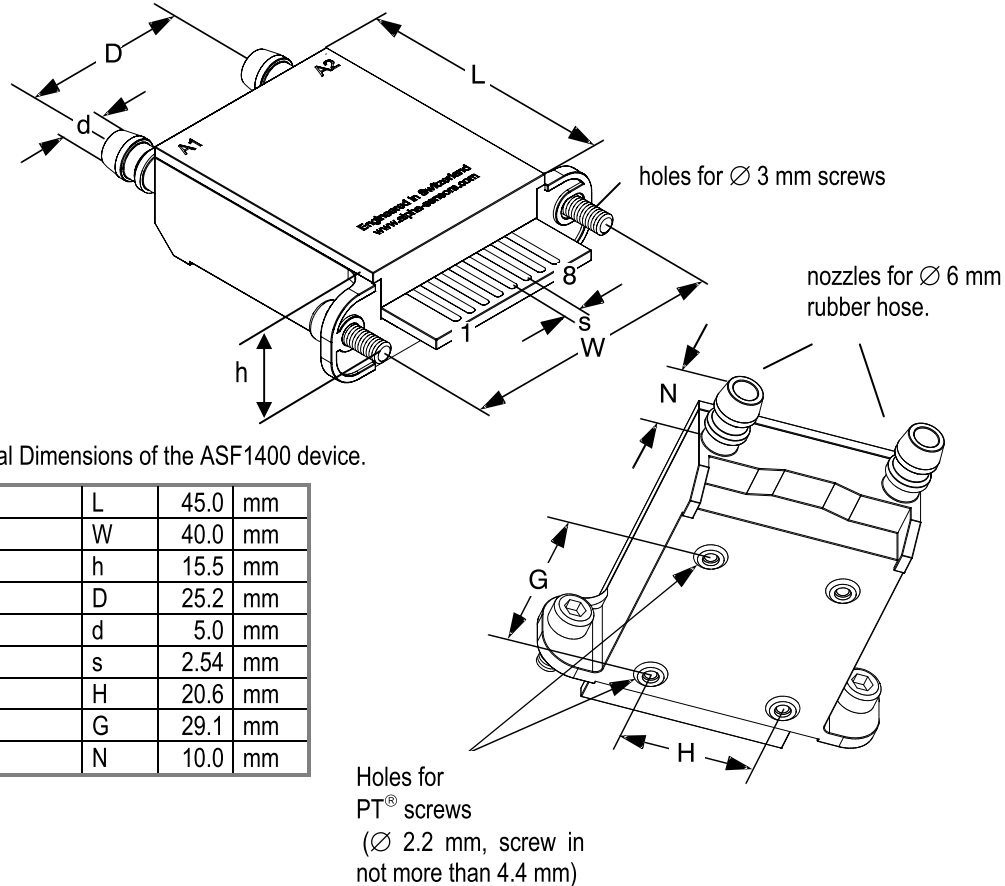

Table 6: Physical Dimensions of the ASF1400 device.

Length	L	45.0	mm
Width	W	40.0	mm
Height	h	15.5	mm
Distance	D	25.2	mm
Diameter	d	5.0	mm
Pitch	s	2.54	mm
Pitch	H	20.6	mm
Pitch	G	29.1	mm
Pitch	N	10.0	mm

Figure 11: Physical dimensions and mounting information of the ASF1400.

## 6 Ordering Information

For small ordering quantities the ASF1400 sensor can be ordered directly at Farnell on <http://www.farnell.com>. Farnell is a worldwide distributor of electrical, electronic and industrial component products.

When ordering ASF1400 series devices at SENSIRION please refer to the following part numbers. For the latest product information access SENSIRION's website on <http://www.sensirion.com>

Calibrated for Gas Type	Range	Packaging	Type
Air	± 400 sccm	2 bar	ASF1400

### Notes:

- Packages to sustain common mode pressures of 10 bars are available on request.
- Special electrical interfaces such as 4-20 mA output or others are available on request.
- For faster response times refer to the ASF1430 data sheet.
- A evaluation kit including ASF1400 devices, evaluation software and other accessories such a bypass, rubber hose and cables can be ordered. For detailed information check out the description of the Mass Flow Meter Evaluation Kit EK-F1 on <http://www.sensirion.com>

## Important Notices

### Warning, personal injury

**Do not use this product as safety or emergency stop devices or in any other application where failure of the product could result in personal injury. Do not use this product for applications other than its intended and authorized use. Before installing, handling, using or servicing this product, please consult the data sheet and application notes. Failure to comply with these instructions could result in death or serious injury.**

If the Buyer shall purchase or use SENSIRION products for any unintended or unauthorized application, Buyer shall defend, indemnify and hold harmless SENSIRION and its officers, employees, subsidiaries, affiliates and distributors against all claims, costs, damages and expenses, and reasonable attorney fees arising out of, directly or indirectly, any claim of personal injury or death associated with such unintended or unauthorized use, even if SENSIRION shall be allegedly negligent with respect to the design or the manufacture of the product.

### ESD Precautions

The inherent design of this component causes it to be sensitive to electrostatic discharge (ESD). To prevent ESD-induced damage and/or degradation, take customary and statutory ESD precautions when handling this product.

See application note "ESD, Latchup and EMC" for more information.

### Warranty

SENSIRION warrants solely to the original purchaser of this product for a period of 12 months (one year) from the date of delivery that this product shall be of the quality, material and workmanship defined in SENSIRION's published specifications of the product. Within such period, if proven to be defective, SENSIRION shall repair and/or replace this product, in SENSIRION's discretion, free of charge to the Buyer, provided that:

- notice in writing describing the defects shall be given to SENSIRION within fourteen (14) days after their appearance;
- such defects shall be found, to SENSIRION's reasonable satisfaction, to have arisen from SENSIRION's faulty design, material, or workmanship;

- the defective product shall be returned to SENSIRION's factory at the Buyer's expense; and
- the warranty period for any repaired or replaced product shall be limited to the unexpired portion of the original period.

This warranty does not apply to any equipment which has not been installed and used within the specifications recommended by SENSIRION for the intended and proper use of the equipment. EXCEPT FOR THE WARRANTIES EXPRESSLY SET FORTH HEREIN, SENSIRION MAKES NO WARRANTIES, EITHER EXPRESS OR IMPLIED, WITH RESPECT TO THE PRODUCT. ANY AND ALL WARRANTIES, INCLUDING WITHOUT LIMITATION, WARRANTIES OF MERCHANTABILITY OR FITNESS FOR A PARTICULAR PURPOSE, ARE EXPRESSLY EXCLUDED AND DECLINED.

SENSIRION is only liable for defects of this product arising under the conditions of operation provided for in the data sheet and proper use of the goods. SENSIRION explicitly disclaims all warranties, express or implied, for any period during which the goods are operated or stored not in accordance with the technical specifications.

SENSIRION does not assume any liability arising out of any application or use of any product or circuit and specifically disclaims any and all liability, including without limitation consequential or incidental damages. All operating parameters, including without limitation recommended parameters, must be validated for each customer's applications by customer's technical experts. Recommended parameters can and do vary in different applications. SENSIRION reserves the right, without further notice, (i) to change the product specifications and/or the information in this document and (ii) to improve reliability, functions and design of this product.

Copyright© 2001-2008, SENSIRION.  
CMOSens® is a trademark of Sensirion  
All rights reserved

### RoHS and WEEE Statement

The SDP6x0 family complies with requirements of the following directives:

- EU Directive 2002/96/EC on waste electrical and electronic equipment (**WEEE**), OJ13.02.2003; esp. its Article 6 (1) with Annex II.
- EU Directive 2002/95/EC on the restriction of the use of certain hazardous substances in electrical and electronic equipment (**RoHS**), OJ 13.02.2003; esp. its Article 4.



## Revision history

Table 1: Revision history

Date	Version	Page(s)	Changes
Dec. 2001	Preliminary	all	First public release
May 2005	V2.1	all	Specifications, typos, various small modifications
November 2008	V2.2	all	SPI interface no longer supported ,overpressure resistance changed, new ISO-Logo, sales Office Information, introduction of revision history, new disclaimer, RoHS compliance

### Headquarters and Sales Office

Sensirion AG  
 Laubisruetistrasse 50  
 CH-8712 Staefa ZH  
 Switzerland

Phone: + 41 44 306 40 00  
 Fax: + 41 44 306 40 30  
 e-mail: [info@sensirion.com](mailto:info@sensirion.com)  
 Web: [www.sensirion.com](http://www.sensirion.com)



### Sales Office USA (for North American customers only)

SENSIRION Inc  
 Westlake Pl. Ctr. I, suite 204  
 2801 Townsgate Road  
 Westlake Village, CA 91361  
 USA

Phone: +1 805-409 4900  
 Fax: +1 805-435 0467  
 e-mail: [michael.karst@sensirion.com](mailto:michael.karst@sensirion.com)  
 Web: [www.sensirion.com](http://www.sensirion.com)

### Sales Office Korea (for Korean customers only)

Sensirion Korea Co. Ltd.  
 #1414, Anyang Construction Twr B/D  
 1112-1, Bisan-dong, Anyang-city  
 Gyeonggi-Province,  
 South Korea

Phone: +82 31-440-9925~27  
 Fax: +82 31-440-9927  
 e-mail: [info@sensirion.co.kr](mailto:info@sensirion.co.kr)  
 Web: [www.sensirion.co.kr](http://www.sensirion.co.kr)

### Sales Office Japan (for Japanese customers only)

Sensirion Japan Co. Ltd  
 Representative Director: Keiichi Hasegawa  
 Shinagawa Station Bldg. 7F, 4-23-5, Takanawa,  
 Minato-ku, Tokyo, Japan

Tel : +81 3-3444-4940  
 Fax: +81 3-3444-4939  
 e-mail: [info@sensirion.co.jp](mailto:info@sensirion.co.jp)  
 Web: [www.sensirion.co.jp](http://www.sensirion.co.jp)