

1. Product profile

1.1 General description

Based on Advanced Rugged Technology (ART), this 150 W LDMOS RF transistor has been designed to cover a wide range of applications for ISM, broadcast and communications. The unmatched transistor has a frequency range of 1 MHz to 650 MHz.

Table 1. Application information

Test signal	f	V _{DS}	P _L	G _p	η _D
	(MHz)	(V)	(W)	(dB)	(%)
CW	64	65	150	31.3	71.4
CW pulsed [1][2]	108	65	150	30.9	75.8
CW [2]	108	65	150	30.3	75.1
CW	128	65	150	28.7	71.0
CW	130	50	88	28.8	72.7
CW	130	32	38	27.2	73.9

[1] $t_p = 100 \mu\text{s}$; $\delta = 10 \%$.

[2] Production circuit.

1.2 Features and benefits

- High breakdown voltage enables class E operation up to $V_{DS} = 53 \text{ V}$
- Qualified up to a maximum of $V_{DS} = 65 \text{ V}$
- Characterized from 30 V to 65 V to support a wide range of applications
- Integrated dual sided ESD protection enables class C operation and complete switch off of the transistor
- Excellent ruggedness with no device degradation
- High efficiency
- Excellent thermal stability
- Designed for broadband operation
- For RoHS compliance see the product details on the Ampleon website

1.3 Applications

- Industrial, scientific and medical applications
 - ◆ Plasma generators
 - ◆ MRI systems
 - ◆ CO₂ lasers
 - ◆ Particle accelerators
 - ◆ Defrosting
- Broadcast
 - ◆ FM radio
 - ◆ VHF TV
- Radar
 - ◆ Non cellular communications
 - ◆ UHF radar

2. Pinning information

Table 2. Pinning

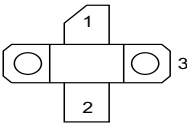
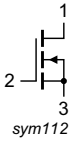
Pin	Description	Simplified outline	Graphic symbol
1	drain		 sym112
2	gate		
3	source		

[1] Connected to flange.

3. Ordering information

Table 3. Ordering information

Package name	Orderable part number	12NC	Packing description	Min. orderable quantity (pieces)
SOT467C	ART150FEU	9349 603 45112	Tray; 20-fold; non-dry pack	60

4. Limiting values

Table 4. Limiting values

In accordance with the Absolute Maximum Rating System (IEC 60134).

Symbol	Parameter	Conditions	Min	Max	Unit
V _{DS}	drain-source voltage	[1]	-	200	V
V _{GS}	gate-source voltage		-9	+13	V
T _{stg}	storage temperature		-65	+150	°C
T _j	junction temperature	[2]	-	225	°C

[1] Specified over lifetime at maximum operating temperature.

[2] Continuous use at maximum temperature will affect the reliability, for details refer to the online MTF calculator.

5. Thermal characteristics

Table 5. Thermal characteristics

Symbol	Parameter	Conditions	Typ	Unit
$R_{th(j-c)}$	thermal resistance from junction to case	$T_{case} = 90\text{ }^{\circ}\text{C}; P_L = 150\text{ W}$ [1]	0.72	K/W
$Z_{th(j-c)}$	transient thermal impedance from junction to case	$T_{case} = 90\text{ }^{\circ}\text{C}; t_p = 100\text{ }\mu\text{s}; \delta = 10\text{ }\%$	0.21	K/W

[1] $R_{th(j-c)}$ is measured under RF conditions.

[2] See [Figure 1](#).

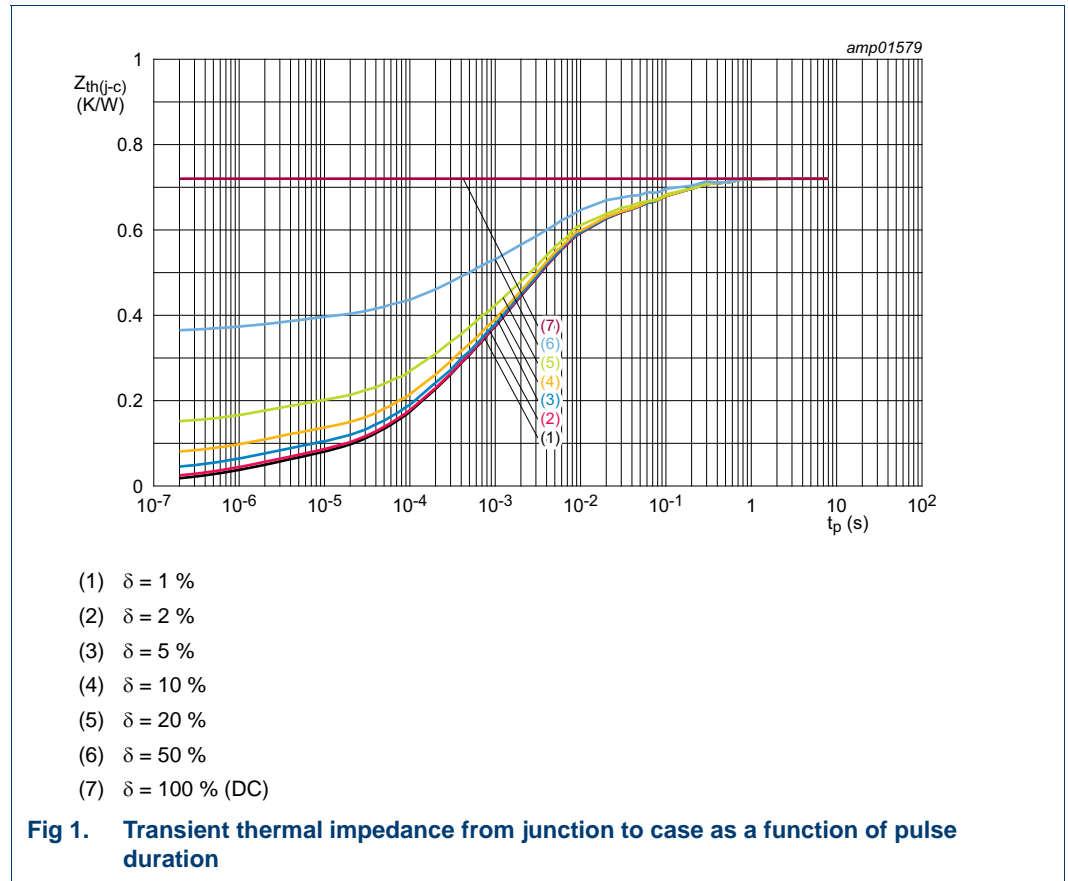

6. Characteristics

Table 6. DC characteristics

$T_j = 25\text{ }^\circ\text{C}$; unless otherwise specified.

Symbol	Parameter	Conditions	Min	Typ	Max	Unit
$V_{(BR)DSS}$	drain-source breakdown voltage	$V_{GS} = 0\text{ V}$; $I_D = 1.11\text{ mA}$	203	209	-	V
$V_{GS(th)}$	gate-source threshold voltage	$V_{DS} = 20\text{ V}$; $I_D = 111\text{ mA}$	1.5	2.1	2.5	V
I_{DSS}	drain leakage current	$V_{GS} = 0\text{ V}$; $V_{DS} = 65\text{ V}$	-	-	1.2	μA
I_{DSX}	drain cut-off current	$V_{GS} = V_{GS(th)} + 3.75\text{ V}$; $V_{DS} = 20\text{ V}$	-	14.7	-	A
I_{GSS}	gate leakage current	$V_{GS} = 13\text{ V}$; $V_{DS} = 0\text{ V}$	-	-	120	nA
$R_{DS(on)}$	drain-source on-state resistance	$V_{GS} = V_{GS(th)} + 3.75\text{ V}$; $I_D = 3.885\text{ A}$	-	0.482	-	Ω

Table 7. AC characteristics

$T_j = 25\text{ }^\circ\text{C}$; unless otherwise specified.

Symbol	Parameter	Conditions	Min	Typ	Max	Unit
C_{rs}	feedback capacitance	$V_{GS} = 0\text{ V}$; $V_{DS} = 65\text{ V}$; $f = 1\text{ MHz}$	-	0.28	-	pF
C_{iss}	input capacitance	$V_{GS} = 0\text{ V}$; $V_{DS} = 65\text{ V}$; $f = 1\text{ MHz}$	-	113	-	pF
C_{oss}	output capacitance	$V_{GS} = 0\text{ V}$; $V_{DS} = 65\text{ V}$; $f = 1\text{ MHz}$	-	34.4	-	pF

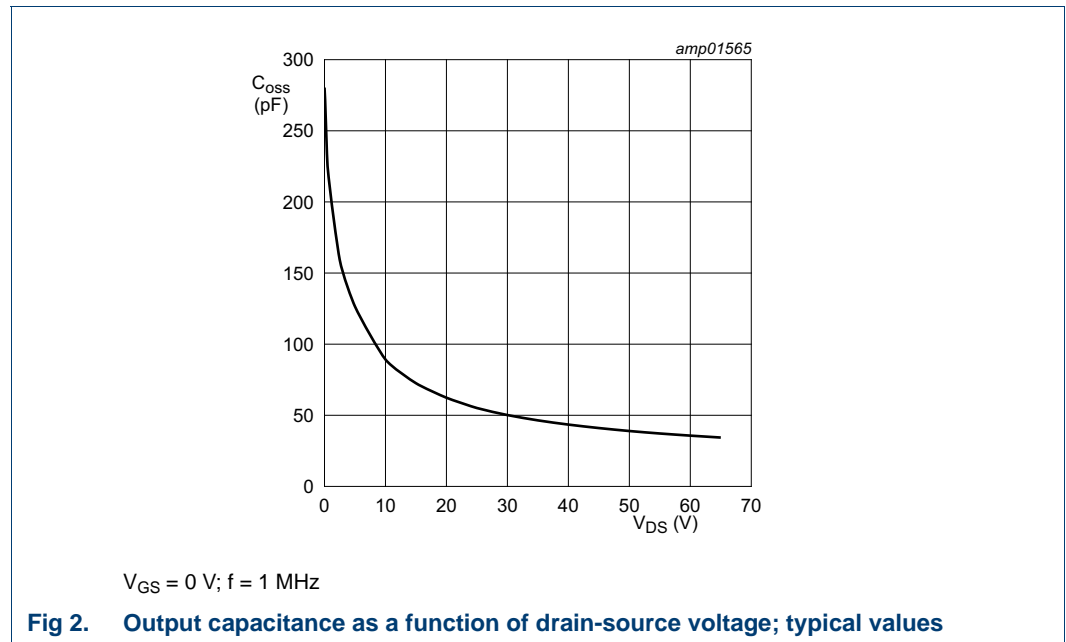

Table 8. RF characteristics

Test signal: CW pulsed; $t_p = 100\text{ }\mu\text{s}$; $\delta = 10\%$; $f = 108\text{ MHz}$; RF performance at $V_{DS} = 65\text{ V}$; $I_{Dq} = 20\text{ mA}$; $T_{case} = 25\text{ }^\circ\text{C}$; unless otherwise specified; in a class-AB production test circuit.

Symbol	Parameter	Conditions	Min	Typ	Max	Unit
G_p	power gain	$P_L = 150\text{ W}$	29	31	-	dB
RL_{in}	input return loss	$P_L = 150\text{ W}$	-	-14	-9	dB
η_D	drain efficiency	$P_L = 150\text{ W}$	68	72	-	%

7. Application information

7.1 Application circuit f = 64 MHz

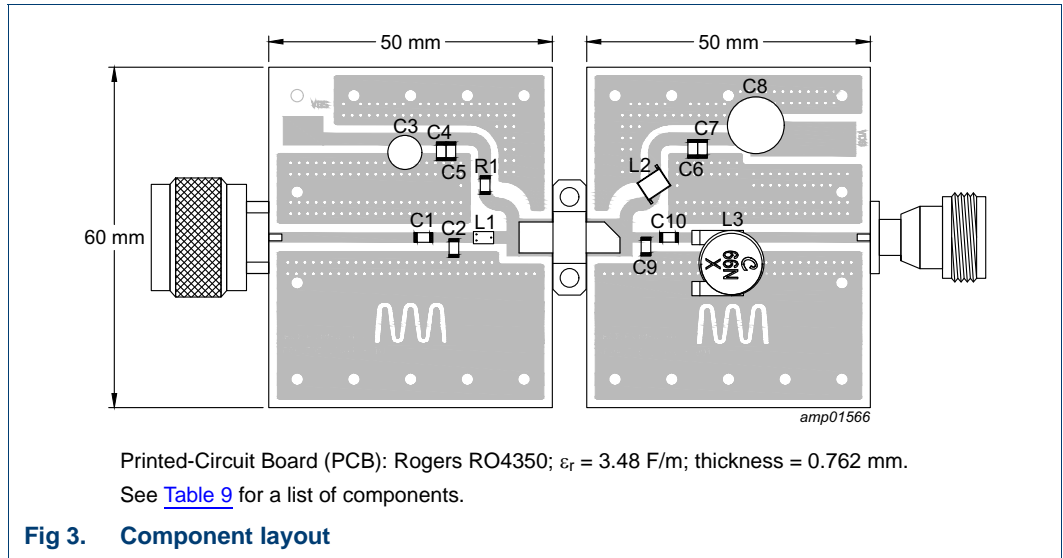
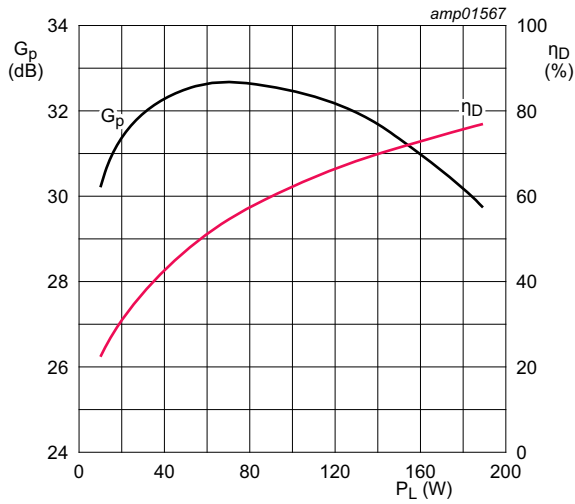

Table 9. List of components

For test circuit see [Figure 3](#).

Component	Description	Value	Remarks
C1, C5, C6	multilayer ceramic chip capacitor	100 nF, 100 V	
C2	multilayer ceramic chip capacitor	100 pF	ATC 800B
C3	electrolytic capacitor	47 μ F	
C4, C7	multilayer ceramic chip capacitor	4.7 μ F, 100 V	
C8	electrolytic capacitor	220 μ F, 100 V	
C9	multilayer ceramic chip capacitor	39 pF	ATC 800B
C10	multilayer ceramic chip capacitor	160 pF	ATC 800B
R1	chip resistor	5.1 k Ω	SMD 1206
L1	chip inductor	120 nH	1206CS
L2	air core inductor	120 nH	1812SMS
L3	air core inductor	66 nH	1212VS-66NME



$V_{DS} = 65$ V; $I_{Dq} = 10$ mA; $f = 64$ MHz.

Fig 4. Power gain and drain efficiency as function of output power; typical values

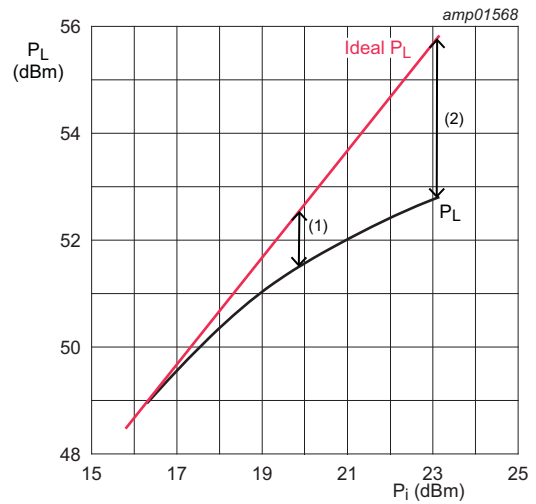

$V_{DS} = 65$ V; $I_{Dq} = 10$ mA; $f = 64$ MHz.

- (1) $P_{L(1dB)} = 51.46$ dBm (140 W)
- (2) $P_{L(3dB)} = 52.81$ dBm (191 W)

Fig 5. Output power as a function of input power; typical values

7.2 Application circuit f = 128 MHz

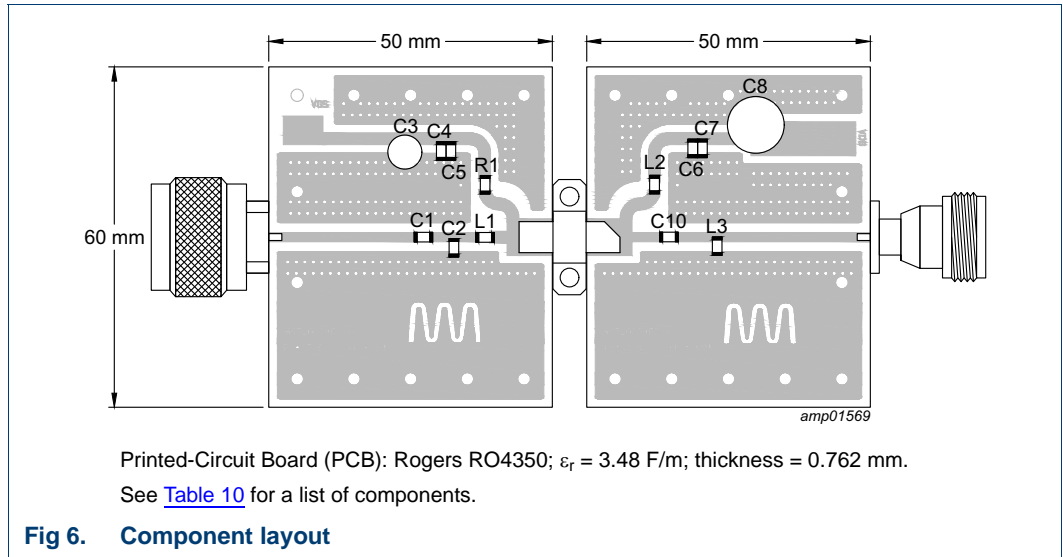
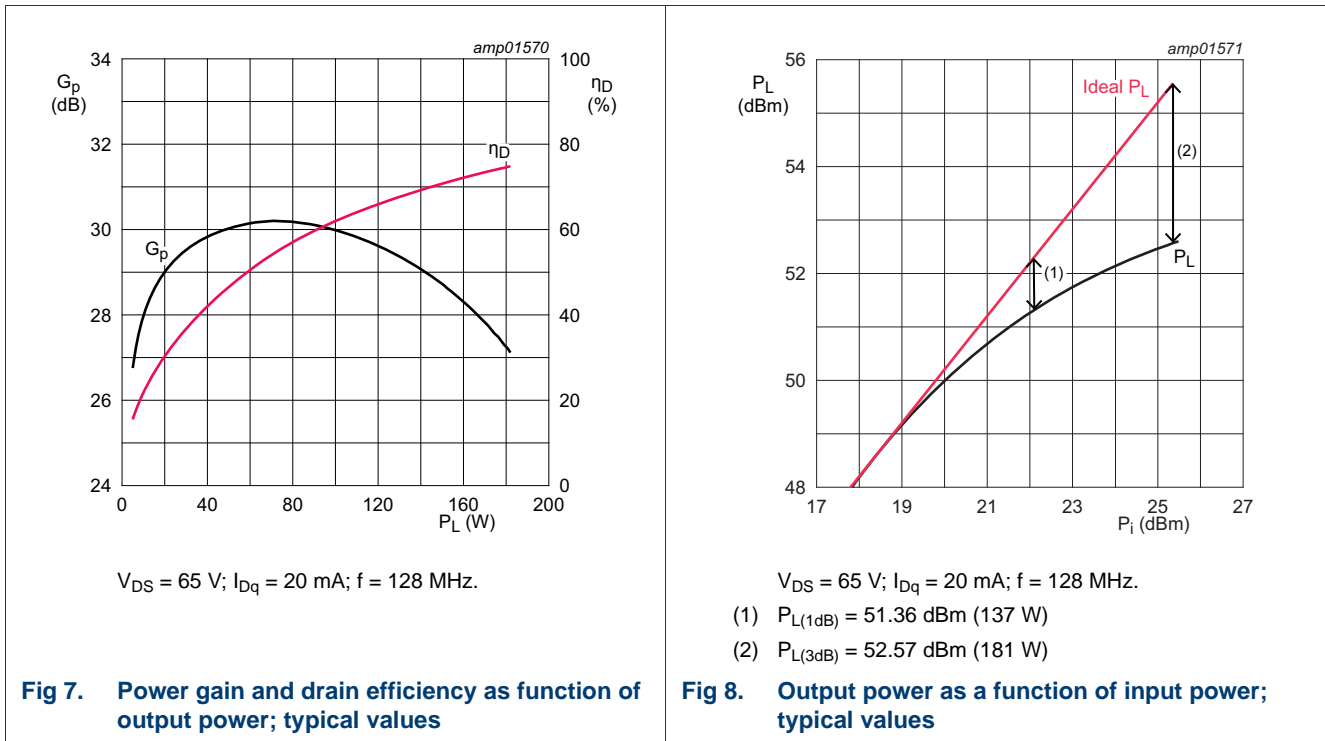

Table 10. List of components

For test circuit see [Figure 6](#).

Component	Description	Value	Remarks
C1, C5, C6	multilayer ceramic chip capacitor	100 nF, 100 V	
C2	multilayer ceramic chip capacitor	91 pF	ATC 800A
C3	electrolytic capacitor	47 μ F	
C4, C7	multilayer ceramic chip capacitor	4.7 μ F, 100 V	
C8	electrolytic capacitor	220 μ F, 100 V	
C10	multilayer ceramic chip capacitor	68 pF	ATC 800B
R1	chip resistor	5.1 k Ω	SMD 1206
L1	chip inductor	27 nH	1206CS
L2	chip inductor	100 nH	1812SMS
L3	air core inductor	4 turns, D = 3 mm, L = 4.1 mm	0.8 mm wire



8. Test information

8.1 Ruggedness in class-AB operation

The ART150FE is capable of withstanding a load mismatch corresponding to $VSWR = 65 \geq 1$ through all phases under the following conditions: $V_{DS} = 65 \text{ V}; I_{Dq} = 20 \text{ mA}; P_L = 150 \text{ W}; f = 108 \text{ MHz}; \text{CW and CW pulsed } (t_p = 100 \mu\text{s}; \delta = 10 \%)$.

8.2 Impedance information

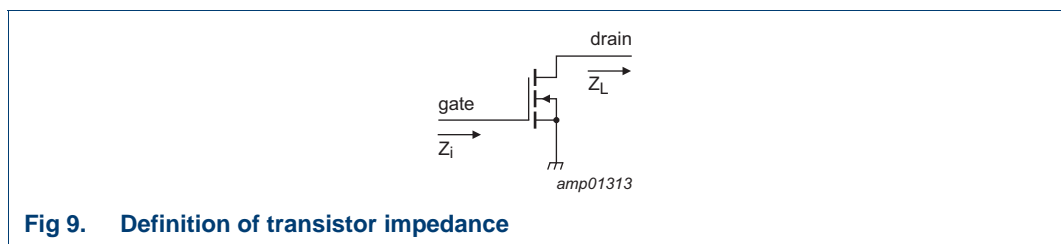

Table 11. Typical impedance

Simulated Z_i and Z_L device impedance; impedance info at $V_{DS} = 65 \text{ V}$ and $P_L = 150 \text{ W}$.

f (MHz)	Z_i (Ω)	Z_L (Ω)
108	$5.5 + j23.0$	$12.1 + j4.8$

8.3 Test circuit

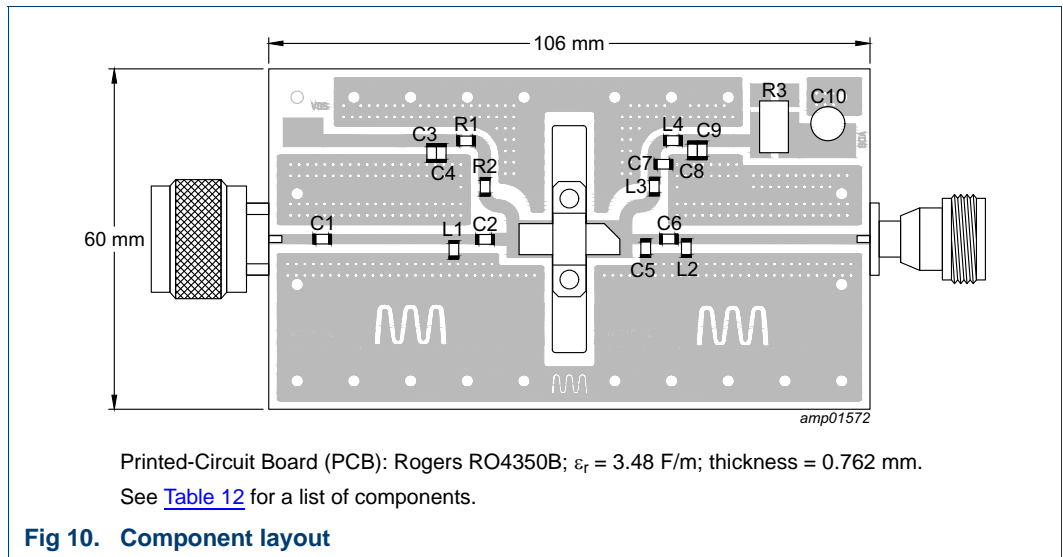

Table 12. List of components

For test circuit see [Figure 10](#).

Component	Description	Value	Remarks
C1, C2	multilayer ceramic chip capacitor	1 nF	ATC 100B
C3, C9	multilayer ceramic chip capacitor	4.7 μ F, 100 V	TDK: C5750X7R2A475K230KA
C4, C8	multilayer ceramic chip capacitor	100 nF, 100 V	AVX: 12061C104KAT2A
C5	multilayer ceramic chip capacitor	18 pF	ATC 100B
C6	multilayer ceramic chip capacitor	91 pF	ATC 100B
C7	multilayer ceramic chip capacitor	750 pF	ATC 100B
C10	electrolytic capacitor	470 μ F, 100 V	Rybicon: 100ZLH470MEFC16X31.5
R1	chip resistor	0 Ω	SMD 1206
R2	chip resistor	5.1 k Ω	SMD 1206
R3	chip resistor	0.01 Ω	Ohmite: FC4L110R010FER
L1	chip inductor	22 nH	Coilcraft: 1206CS-220XJE
L2	air core inductor	35.5 nH	Coilcraft: B09TGLC
L3	air core inductor	82 nF	Coilcraft: 1812sms-R10GLB
L4	SM bead	Z47, 100 MHz	Fair Rite: 2743019447

8.4 Graphical data

8.4.1 1-Tone CW

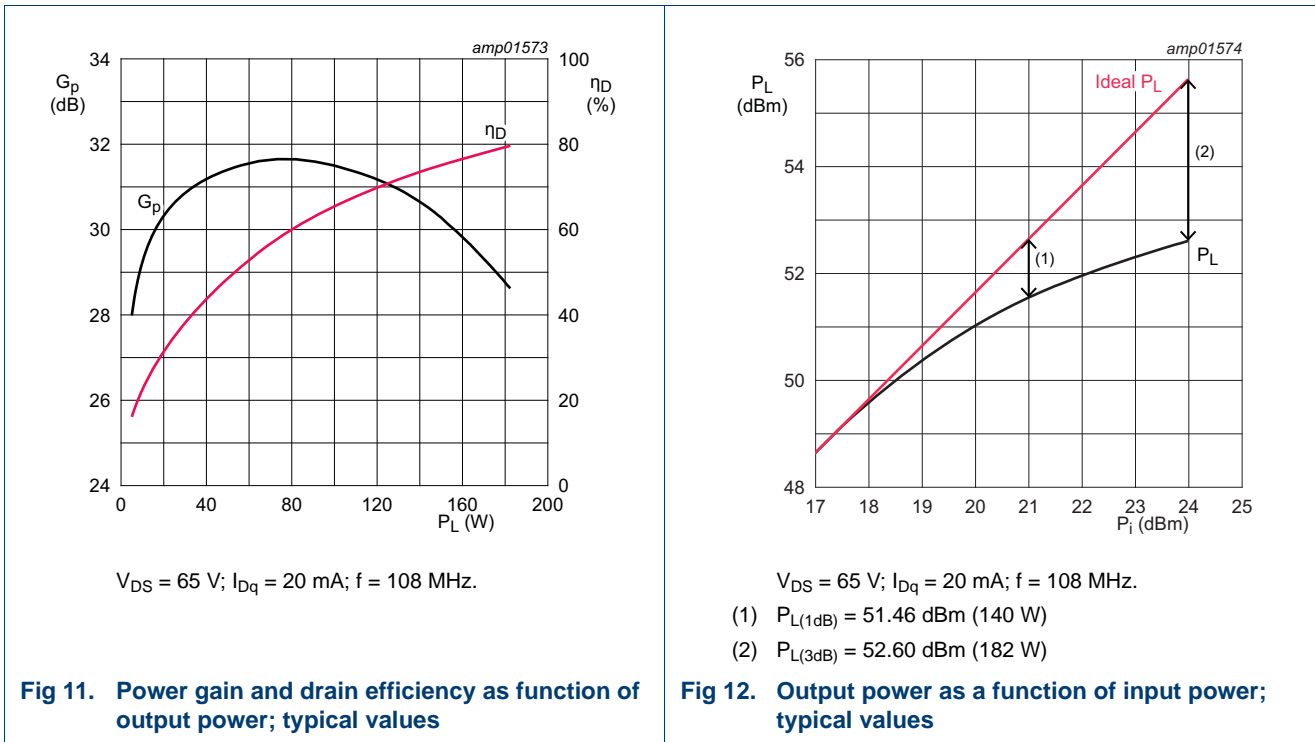

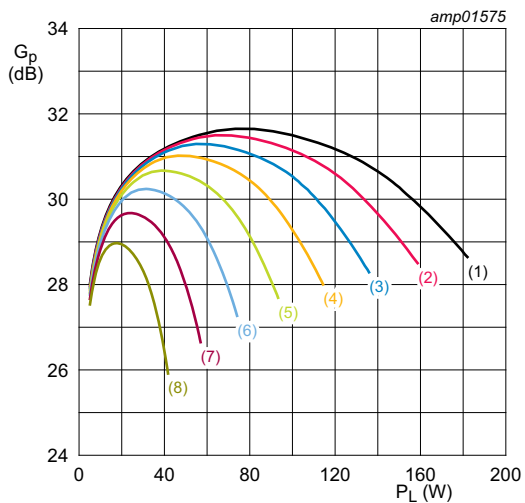

$I_{Dq} = 20 \text{ mA}; f = 108 \text{ MHz.}$

- (1) $V_{DS} = 65 \text{ V}$
- (2) $V_{DS} = 60 \text{ V}$
- (3) $V_{DS} = 55 \text{ V}$
- (4) $V_{DS} = 50 \text{ V}$
- (5) $V_{DS} = 45 \text{ V}$
- (6) $V_{DS} = 40 \text{ V}$
- (7) $V_{DS} = 35 \text{ V}$
- (8) $V_{DS} = 30 \text{ V}$

Fig 13. Power gain as a function of output power; typical values

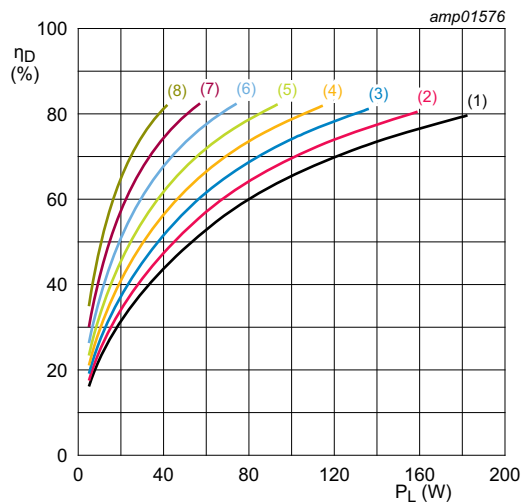

$I_{Dq} = 20 \text{ mA}; f = 108 \text{ MHz.}$

- (1) $V_{DS} = 65 \text{ V}$
- (2) $V_{DS} = 60 \text{ V}$
- (3) $V_{DS} = 55 \text{ V}$
- (4) $V_{DS} = 50 \text{ V}$
- (5) $V_{DS} = 45 \text{ V}$
- (6) $V_{DS} = 40 \text{ V}$
- (7) $V_{DS} = 35 \text{ V}$
- (8) $V_{DS} = 30 \text{ V}$

Fig 14. Drain efficiency as a function of output power; typical values

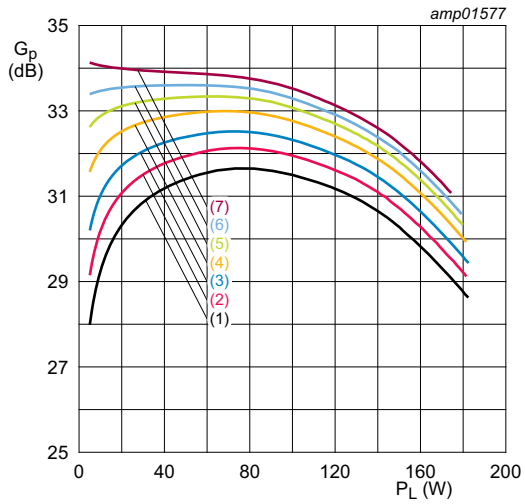

$V_{DS} = 65 \text{ V}; f = 108 \text{ MHz.}$

- (1) $I_{Dq} = 20 \text{ mA}$
- (2) $I_{Dq} = 50 \text{ mA}$
- (3) $I_{Dq} = 100 \text{ mA}$
- (4) $I_{Dq} = 200 \text{ mA}$
- (5) $I_{Dq} = 300 \text{ mA}$
- (6) $I_{Dq} = 400 \text{ mA}$
- (7) $I_{Dq} = 500 \text{ mA}$

Fig 15. Power gain as a function of output power; typical values

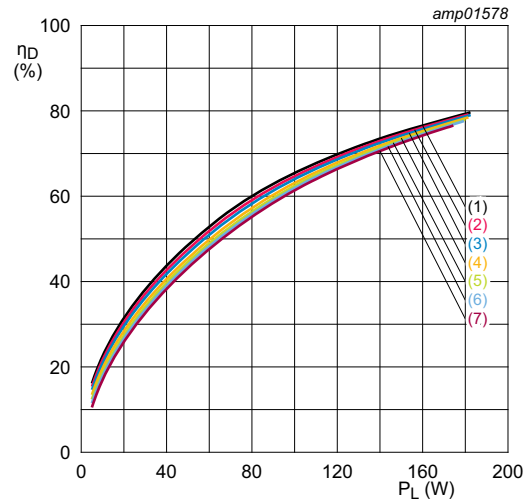

$V_{DS} = 65 \text{ V}; f = 108 \text{ MHz.}$

- (1) $I_{Dq} = 20 \text{ mA}$
- (2) $I_{Dq} = 50 \text{ mA}$
- (3) $I_{Dq} = 100 \text{ mA}$
- (4) $I_{Dq} = 200 \text{ mA}$
- (5) $I_{Dq} = 300 \text{ mA}$
- (6) $I_{Dq} = 400 \text{ mA}$
- (7) $I_{Dq} = 500 \text{ mA}$

Fig 16. Drain efficiency as a function of output power; typical values

9. Package outline

Flanged ceramic package; 2 mounting holes; 2 leads

SOT467C

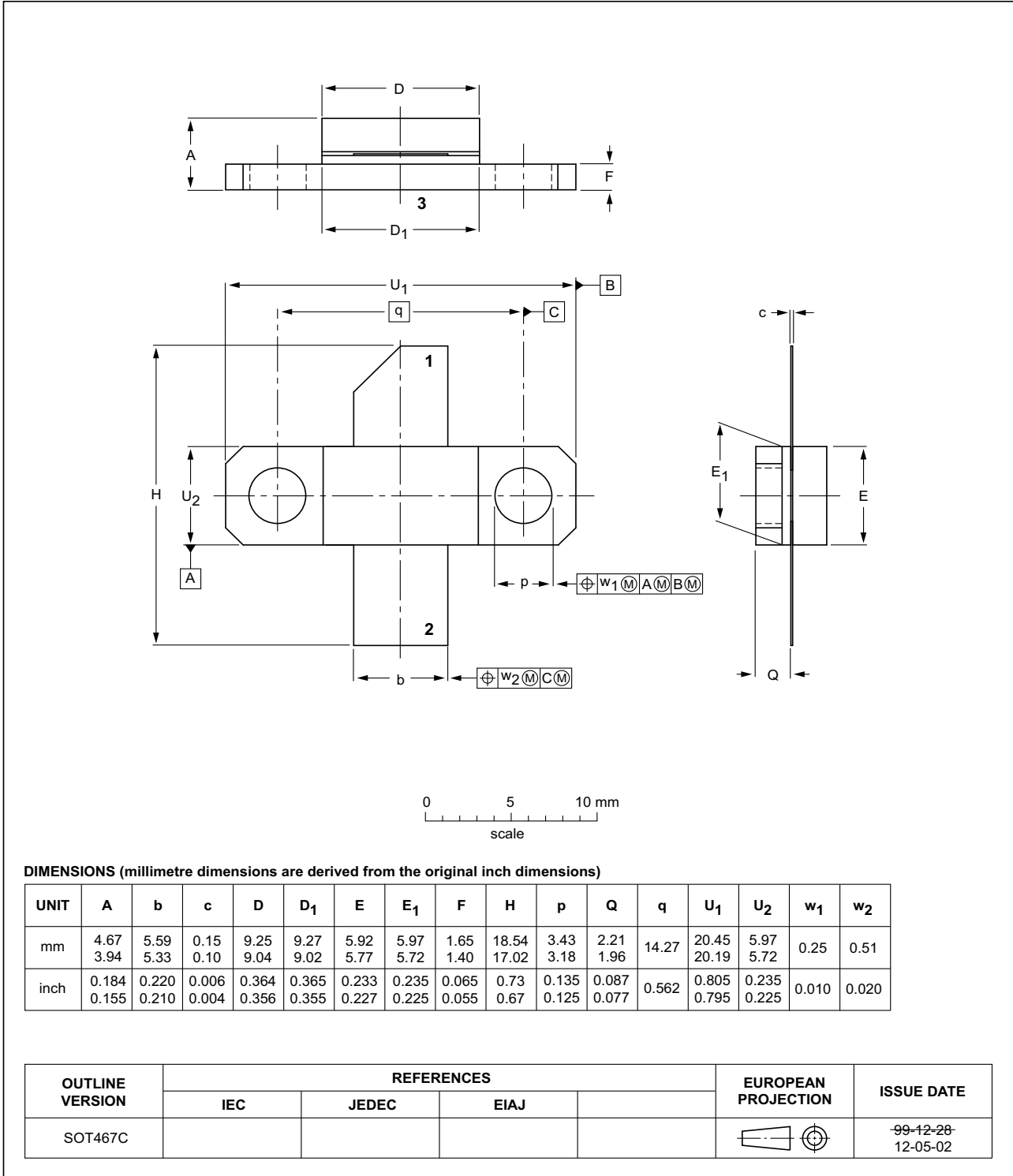

Fig 17. Package outline SOT467C

10. Handling information

CAUTION



This device is sensitive to ElectroStatic Discharge (ESD). Observe precautions for handling electrostatic sensitive devices.

Such precautions are described in the *ANSI/ESD S20.20*, *IEC/ST 61340-5*, *JESD625-A* or equivalent standards.

Table 13. ESD sensitivity

ESD model	Class
Charged Device Model (CDM); According to ANSI/ESDA/JEDEC standard JS-002	C2A [1]
Human Body Model (HBM); According to ANSI/ESDA/JEDEC standard JS-001	2 [2]

[1] CDM classification C2A is granted to any part that passes after exposure to an ESD pulse of 500 V.

[2] HBM classification 2 is granted to any part that passes after exposure to an ESD pulse of 2000 V.

11. Abbreviations

Table 14. Abbreviations

Acronym	Description
CW	Continuous Wave
ESD	ElectroStatic Discharge
FM	Frequency Modulation
ISM	Industrial, Scientific and Medical
LDMOS	Laterally Diffused Metal-Oxide Semiconductor
MRI	Magnetic Resonance Imaging
MTF	Median Time to Failure
RoHS	Restriction of Hazardous Substances
SMD	Surface Mounted Device
UHF	Ultra High Frequency
VHF	Very High Frequency
VSWR	Voltage Standing Wave Ratio

12. Revision history

Table 15. Revision history

Document ID	Release date	Data sheet status	Change notice	Supersedes
ART150FE v.2	20220708	Product data sheet	-	ART150FE v.1
Modifications:	<ul style="list-style-type: none"> • Section 1.2 on page 1: first list item, changed value drain-source voltage • Table 4 on page 2: changed values gate-source voltage • Table 6 on page 4: changed value gate-source voltage • Section 13.2 on page 15: updated section • Section 13.3 on page 15: updated section 			
ART150FE v.1	20210104	Product data sheet	-	-

13. Legal information

13.1 Data sheet status

Document status ^{[1][2]}	Product status ^[3]	Definition
Objective [short] data sheet	Development	This document contains data from the objective specification for product development.
Preliminary [short] data sheet	Qualification	This document contains data from the preliminary specification.
Product [short] data sheet	Production	This document contains the product specification.

[1] Please consult the most recently issued document before initiating or completing a design.

[2] The term 'short data sheet' is explained in section "Definitions".

[3] The product status of device(s) described in this document may have changed since this document was published and may differ in case of multiple devices. The latest product status information is available on the Internet at URL <http://www.ampleon.com>.

13.2 Definitions

Draft — The document is a draft version only. The content is still under internal review and subject to formal approval, which may result in modifications or additions. Ampleon does not give any representations or warranties as to the accuracy or completeness of information included herein and shall have no liability for the consequences of use of such information.

Short data sheet — A short data sheet is an extract from a full data sheet with the same product type number(s) and title. A short data sheet is intended for quick reference only and should not be relied upon to contain detailed and full information. For detailed and full information see the relevant full data sheet, which is available on request via the local Ampleon sales office. In case of any inconsistency or conflict with the short data sheet, the full data sheet shall prevail.

Product specification — The information and data provided in a Product data sheet shall define the specification of the product as agreed between Ampleon and its customer, unless Ampleon and customer have explicitly agreed otherwise in writing. An agreement according to which the functions and qualities of Ampleon products exceed those described in the Product data sheet is invalid.

Right to make changes — Ampleon reserves the right to change information including but without limitation specifications and product descriptions published in this document at any time and without notice. This document supersedes and replaces all information regarding these products supplied prior to the publication hereof.

Suitability for use — Ampleon products are not designed, authorized or warranted to be suitable for use in life support, life-critical or safety-critical systems or equipment, nor in applications where failure or malfunction of an Ampleon product can reasonably be expected to result in personal injury, death or severe property or environmental damage. Insofar as a customer or another party nevertheless uses Ampleon products unlawfully for such purposes, Ampleon and its suppliers are not liable for any damages.

Applications — Applications that are described herein for any of these products are for illustrative purposes only. Ampleon makes no representation or warranty that such applications will be suitable for the specified use without further testing or modification.

Customers are responsible for the design and operation of their applications and products using Ampleon products, and Ampleon is not liable for any assistance with applications or customer product design. It is customer's sole responsibility to determine whether the Ampleon product is suitable and fit for the customer's applications and products planned, as well as for the planned application and use of customer's third party customer(s). Customers shall provide appropriate design and operating safeguards to minimize the risks associated with their applications and products.

Ampleon is not liable related to any default, damage, costs or problem which is based on any weakness or default in the customer's applications or products, or the application or use by customer's third party customer(s). Customer is responsible for and shall do all necessary testing for the customer's applications and products using Ampleon products in order to avoid a default of the applications and the products or of the application or use by customer's third party customer(s). Ampleon is not liable in this respect.

Limiting values — Stress above one or more limiting values (as defined in the Absolute Maximum Ratings System of IEC 60134) will cause permanent damage to the device. Limiting values are stress ratings only and (proper) operation of the device at these or any other conditions above those given in the Recommended operating conditions section (if present) or the Characteristics sections of this document is not guaranteed. Constant or repeated exposure to limiting values will permanently and irreversibly affect the quality and reliability of the device.

Terms and conditions of commercial sale — Ampleon products are sold subject to the general terms and conditions of commercial sale, as published at <http://www.ampleon.com/terms>, unless otherwise agreed in a valid written individual agreement. In the event of signing an individual agreement the terms and conditions of the respective agreement shall apply. Ampleon hereby expressly objects to and rejects the validity of customer's terms and conditions regarding the purchase of Ampleon products by customer.

13.3 Disclaimers

Maturity — After the relevant product(s) have passed the Release Gate in Ampleon's release process, Ampleon will confirm the final version in writing.

Limited warranty and liability — Ampleon uses its best efforts to keep the information in this document accurate and reliable. However, Ampleon gives no representations or warranties, expressed or implied, as to the accuracy or completeness of such information and assumes no liability for the consequences of the use of such information. Ampleon is not liable for content provided by an external information source.

In no event and irrespective of the legal basis (contract, tort (including negligence) statutory liability, misrepresentation, indemnity or any other area of law) shall Ampleon be liable for any indirect, incidental, punitive, special or consequential damages (including but without limitation loss of profit or revenue, loss of use or loss of production, loss of data, cost of capital, cost of substitute goods, property damage external to the Ampleon products and any damage, expenditure or loss arising out of such damage, business interruption, costs related to the removal or replacement of any products or rework charges) or any of the foregoing suffered by any third party.

Notwithstanding any damages that customer might incur for any reason whatsoever, Ampleon's aggregate and cumulative liability towards customer for the products described herein shall be limited in accordance with the *Terms and conditions of commercial sale* of Ampleon.

No offer to sell or license — Nothing in this document may be interpreted or construed as an offer to sell products that is open for acceptance or the grant, conveyance or implication of any license under any copyrights, patents or other industrial or intellectual property rights.

Export control — This document as well as the item(s) described herein may be subject to export control regulations. Export might require a prior authorization from competent authorities.

Non-automotive qualified products — Unless this data sheet expressly states that this specific Ampleon product is automotive qualified, the product is not suitable for automotive use. It is neither qualified nor tested in accordance with automotive testing or application requirements. Ampleon is not liable for inclusion and/or use of non-automotive qualified products in automotive equipment or applications.

In the event that customer breaches this and uses the products for design and use in automotive applications in accordance with automotive specifications and standards, (a) Ampleon gives no warranty, representation

or other guarantees of any kind with respect to such automotive applications, use and specifications, and (b) such use is solely and exclusively at customer's own risk, and (c) customer fully indemnifies Ampleon against any and all liability, damages or failed product claims, including against third parties, arising out of customer's design and use of the product for automotive applications.

Translations — A non-English (translated) version of a document is for reference only. The English version shall prevail in case of any discrepancy between the translated and English versions.

13.4 Trademarks

Notice: All referenced brands, product names, service names and trademarks are the property of their respective owners.

14. Contact information

For more information, please visit: <http://www.ampleon.com>

For sales office addresses, please visit: <http://www.ampleon.com/sales>

15. Contents

1 **Product profile** 1

1.1 General description 1

1.2 Features and benefits 1

1.3 Applications 2

2 **Pinning information** 2

3 **Ordering information** 2

4 **Limiting values** 2

5 **Thermal characteristics** 3

6 **Characteristics** 4

7 **Application information** 5

7.1 Application circuit f = 64 MHz 5

7.2 Application circuit f = 128 MHz 7

8 **Test information** 8

8.1 Ruggedness in class-AB operation 8

8.2 Impedance information 8

8.3 Test circuit 9

8.4 Graphical data 10

8.4.1 1-Tone CW 10

9 **Package outline** 13

10 **Handling information** 14

11 **Abbreviations** 14

12 **Revision history** 14

13 **Legal information** 15

13.1 Data sheet status 15

13.2 Definitions 15

13.3 Disclaimers 15

13.4 Trademarks 16

14 **Contact information** 16

15 **Contents** 17

Please be aware that important notices concerning this document and the product(s) described herein, have been included in section 'Legal information'.

© Ampleon Netherlands B.V. 2022. All rights reserved.

For more information, please visit: <http://www.ampleon.com>
 For sales office addresses, please visit: <http://www.ampleon.com/sales>

Date of release: 8 July 2022
 Document identifier: ART150FE