



User Manual

ARK-2150

Fanless Embedded Box PC

Attention!

Please note:

This package contains a hard-copy user manual in Chinese for China CCC certification purposes, and there is an English user manual included as a PDF file on the CD. Please disregard the Chinese hard copy user manual if the product is not to be sold and/or installed in China.

Copyright

The documentation and the software included with this product are copyrighted 2010 by Advantech Co., Ltd. All rights are reserved. Advantech Co., Ltd. reserves the right to make improvements in the products described in this manual at any time without notice.

No part of this manual may be reproduced, copied, translated or transmitted in any form or by any means without the prior written permission of Advantech Co., Ltd. Information provided in this manual is intended to be accurate and reliable. However, Advantech Co., Ltd. assumes no responsibility for its use, nor for any infringements of the rights of third parties, which may result from its use.

Acknowledgements

Award is a trademark of Award Software International, Inc.

VIA is a trademark of VIA Technologies, Inc.

IBM, PC/AT, PS/2 and VGA are trademarks of International Business Machines Corporation.

Intel® and Pentium® are trademarks of Intel Corporation.

Microsoft Windows® is a registered trademark of Microsoft Corp.

RTL is a trademark of Realtek Semi-Conductor Co., Ltd.

ESS is a trademark of ESS Technology, Inc.

UMC is a trademark of United Microelectronics Corporation.

SMI is a trademark of Silicon Motion, Inc.

Creative is a trademark of Creative Technology LTD.

CHRONTEL is a trademark of Chrontel Inc.

All other product names or trademarks are properties of their respective owners.

For more information about this and other Advantech products, please visit our website at:

<http://www.emacinc.com/>

For technical support and service, please visit our support website at:

<http://www.emacinc.com/support/>

Product Warranty (2 years)

Advantech warrants to you, the original purchaser, that each of its products will be free from defects in materials and workmanship for two years from the date of purchase.

This warranty does not apply to any products which have been repaired or altered by persons other than repair personnel authorized by Advantech, or which have been subject to misuse, abuse, accident or improper installation. Advantech assumes no liability under the terms of this warranty as a consequence of such events.

Because of Advantech's high quality-control standards and rigorous testing, most of our customers never need to use our repair service. If an Advantech product is defective, it will be repaired or replaced at no charge during the warranty period. For out-of-warranty repairs, you will be billed according to the cost of replacement materials, service time and freight. Please consult your dealer for more details.

If you think you have a defective product, follow these steps:

1. Collect all the information about the problem encountered. (For example, CPU speed, Advantech products used, other hardware and software used, etc.) Note anything abnormal and list any onscreen messages you get when the problem occurs.
2. Call your dealer and describe the problem. Please have your manual, product, and any helpful information readily available.
3. If your product is diagnosed as defective, obtain an RMA (return merchandise authorization) number from your dealer. This allows us to process your return more quickly.
4. Carefully pack the defective product, a fully-completed Repair and Replacement Order Card and a photocopy proof of purchase date (such as your sales receipt) in a shippable container. A product returned without proof of the purchase date is not eligible for warranty service.
5. Write the RMA number visibly on the outside of the package and ship it prepaid to your dealer.

Declaration of Conformity

FCC Class A

Note: This equipment has been tested and found to comply with the limits for a Class A digital device, pursuant to part 15 of the FCC Rules. These limits are designed to provide reasonable protection against harmful interference when the equipment is operated in a commercial environment. This equipment generates, uses, and can radiate radio frequency energy and, if not installed and used in accordance with the instruction manual, may cause harmful interference to radio communications. Operation of this equipment in a residential area is likely to cause harmful interference in which case the user will be required to correct the interference at his own expense.

Technical Support and Assistance

1. Visit the Advantech web site at www.advantech.com/support where you can find the latest information about the product.
2. Contact your distributor, sales representative, or Advantech's customer service center for technical support if you need additional assistance. Please have the following information ready before you call:
 - Product name and serial number
 - Description of your peripheral attachments
 - Description of your software (operating system, version, application software, etc.)
 - A complete description of the problem
 - The exact wording of any error messages

Warnings, Cautions and Notes

Warning! *Warnings indicate conditions, which if not observed, can cause personal injury!*



Caution! *Cautions are included to help you avoid damaging hardware or losing data. e.g.*



There is a danger of a new battery exploding if it is incorrectly installed. Do not attempt to recharge, force open, or heat the battery. Replace the battery only with the same or equivalent type recommended by the manufacturer. Discard used batteries according to the manufacturer's instructions.

Note! *Notes provide optional additional information.*



Packing List

Before installation, please ensure the following items have been shipped:

- 1 x ARK-2150 unit
- 1 x Driver/Utility CD
- 1 x Registration and 2 years Warranty card
- 1 x China RoHS
- 1 x 2-Pole Phoenix to DC-Jack Power cable (F model)

Ordering Information

Model Number	Description
ARK-2150L-S6A1E	Intel Core i3 3217UE 1.6GHz fanless EBC, VGA+HDMI, 2GbE, 2USB3.0, 4COM
ARK-2150L-S7A1E	Intel Core i7 3517UE 1.7GHz fanless EBC, VGA+HDMI, 2GbE, 2USB3.0, 4COM
ARK-2150F-S6A1E	Intel Core i3 3217UE 1.6GHz fanless EBC, VGA+HDMI+DVI-D, 4GbE, 3USB3.0, 4COM
ARK-2150F-S7A1E	Intel Core i7 3517UE 1.7GHz fanless EBC, VGA+HDMI+DVI-D, 4GbE, 3USB3.0, 4COM

Optional Accessories

For ARK-2150L

Part Number	Description
1757003934	AC-to-DC Adapter, DC 12V/5A 60W, 0 ~ 40° C for Home and Office Use
1702002600	Power cable 3-pin 180 cm, USA type
1702031801	Power cable 3-pin 180 cm, UK type
1702002605	Power cable 3-pin 180 cm, Europe type
1700000237	Power cable 3-pin 180 cm, PSE
9666K10000E	DIN-rail mounting kit
1960025333N00N	VESA mounting kit

For ARK-2150F

Part Number	Description
1757003659	AC-to-DC Adapter, DC19 V/3.42 A 65 W, with Phoenix Power Plug, 0 ~ 40° C for Home and Office Use
1700001947	Power cable 2-pin 180 cm, USA for ARK-338X
1700001948	Power cable 2-pin 180 cm, Europe for ARK-338X
1700001949	Power cable 2-pin 180 cm, UK for ARK-338X
1700009001	2-Pole Phoenix to DC-Jack Power cable
9666K10000E	DIN-rail mounting kit
1960025333N00N	VESA mounting kit

Safety Instructions

1. Please read these safety instructions carefully.
2. Please keep this User's Manual for later reference.
3. Please disconnect this equipment from AC outlet before cleaning. Use a damp cloth. Don't use liquid or sprayed detergent for cleaning. Use moisture sheet or clothe for cleaning.
4. For pluggable equipment, the socket-outlet shall near the equipment and shall be easily accessible.
5. Please keep this equipment from humidity.
6. Lay this equipment on a reliable surface when install. A drop or fall could cause injury.
7. The openings on the enclosure are for air convection hence protecting the equipment from overheating. **DO NOT COVER THE OPENINGS.**
8. Make sure the voltage of the power source when connecting the equipment to the power outlet.
9. Place the power cord such a way that people cannot step on it. Do not place anything over the power cord.
10. All cautions and warnings on the equipment should be noted.
11. If the equipment is not used for long time, disconnect the equipment from mains to avoid being damaged by transient over-voltage.
12. Never pour any liquid into ventilation openings; this could cause fire or electrical shock.
13. Never open the equipment. For safety reasons, only qualified service personnel should open the equipment.
14. If one of the following situations arises, get the equipment checked by service personnel:
 - The power cord or plug is damaged.
 - Liquid has penetrated into the equipment.
 - The equipment has been exposed to moisture.
 - The equipment does not work well, or you cannot get it to work according to the user's manual.
 - The equipment has been dropped and damaged.
 - The equipment has obvious signs of breakage.
15. Do not leave this equipment in an environment where the storage temperature may go below -40°C (-40°F) or above 85°C (185°F). This could damage the equipment. the equipment should be in a controlled environment.
16. Caution: Danger of explosion if battery is incorrectly replaced. Replace only with the same or equivalent type recommended by the manufacturer, discard used batteries according to the manufacturer's instructions.
17. The sound pressure level at the operator's position according to IEC 704-1:1982 is no more than 70 dB (A).
18. **RESTRICTED ACCESS AREA:** The equipment should only be installed in a Restricted Access Area.
19. **DISCLAIMER:** This set of instructions is given according to IEC 704-1. Advan-tech disclaims all responsibility for the accuracy of any statements contained herein.

Contents

Chapter 1 General Introduction1

1.1	Introduction	2
1.2	Product Features.....	3
	1.2.1 General	3
	1.2.2 Display	3
	1.2.3 Ethernet	3
1.3	Chipset.....	4
	1.3.1 Functional Specification	4
	1.3.2 iManager.....	6
1.4	Mechanical Specifications.....	7
	1.4.1 Dimensions	7
	Figure 1.1 ARK-2150 Mechanical dimension drawing.....	7
	1.4.2 Weight.....	7
1.5	Power Requirement	7
	1.5.1 System Power.....	7
	1.5.2 RTC Battery	7
1.6	Environment Specification.....	8
	1.6.1 Operating Temperature.....	8
	1.6.2 Relative Humidity	8
	1.6.3 Storage Temperature.....	8
	1.6.4 Vibration during Operation	8
	1.6.5 Shock during Operation	8
	1.6.6 Safety.....	8
	1.6.7 EMC.....	8

Chapter 2 H/W Installation.....9

2.1	Introduction	10
2.2	Jumpers	10
	2.2.1 Jumper Description	10
	2.2.2 Jumper List	11
	Table 2.1: Jumper List of Main Board.....	11
	2.2.3 Jumper Location	11
	Figure 2.1 Jumper layout.....	11
	2.2.4 Jumper Setting.....	11
	Table 2.2: Clear CMOS (JP1).....	11
	Table 2.3: Auto Power On Setting (J2).....	12
	Table 2.4: LVDS Panel Power Select (J4).....	12
2.3	Connectors.....	13
	2.3.1 ARK-2150 External I/O Connectors	13
	Figure 2.2 ARK-2150L IO connectors drawing	13
	Figure 2.3 ARK-2150F IO connectors drawing.....	14
	Figure 2.4 COM connector	14
	Table 2.5: COM Connector Pin Assignments	14
	Figure 2.5 Ethernet connector	15
	Table 2.6: Ethernet Connector Pin Assignments.....	15
	Figure 2.6 Audio connector.....	15
	Table 2.7: Audio Connector Pin Assignments	15
	Figure 2.7 DIO Connector (ARK-2150L).....	15
	Table 2.8: DIO Connector Pin Assignments (ARK-2150L).....	16
	Figure 2.8 Isolated DIO connector (ARK-2150F).....	16
	Table 2.9: DIO Connector Pin Assignments (ARK-2150F).....	16
	Figure 2.9 USB3.0 Connector.....	16
	Table 2.10: USB 3.0 Connector.....	17

	Figure 2.10 USB2.0 connector	17
	Table 2.11: USB2.0 Connector	17
	Figure 2.11 VGA Connector	17
	Table 2.12: VGA Connector Pin Assignments	17
	Figure 2.12 HDMI / Display Port Connector	18
	Table 2.13: HDMI / Display Port Connector Pin Assignments	18
	Figure 2.13 Power Input Connector (ARK-2150L).....	18
	Figure 2.14 Compatible dimension of DC Plug for ARK-2150L...	18
	Figure 2.15 Power Input Connector (ARK-2150F)	19
	Table 2.14: Power connector Pin Assignments (ARK-2150F)	19
	Figure 2.16 Power Button.....	19
	Figure 2.17 LED Indicators.....	19
	Figure 2.18 DIO Connector	19
	Table 2.15: DVI-D Connector Pin Assignments	19
2.4	Installation.....	20
2.4.1	HDD Installation.....	20
2.4.2	Memory Installation.....	21
2.4.3	MiniPCIe module and mSATA Installation.....	23

Chapter 3 BIOS Settings 25

	Figure 3.1 Setup program initial screen.....	26
3.1	Entering Setup	26
3.2	Main Setup.....	26
	Figure 3.2 Main setup screen	27
3.2.1	System time / System date	27
3.3	Advanced BIOS Features Setup.....	27
	Figure 3.3 Advanced BIOS features setup screen	28
3.3.1	ACPI Settings	28
	Figure 3.4 ACPI Setting.....	28
3.3.2	CPU Configuration.....	29
	Figure 3.5 CPU Configuration	29
3.3.3	SATA Configuration	30
	Figure 3.6 SATA Configuration.....	30
3.3.4	PCH-FW Configuration.....	31
	Figure 3.7 PCH-FW Configuration.....	31
3.3.5	AMT Configuration.....	32
	Figure 3.8 AMT Configuration	32
3.3.6	USB Configuration	33
	Figure 3.9 USB Configuration.....	33
3.3.7	SMART Settings	34
	Figure 3.10 SMART Settings.....	34
3.3.8	IT8760 Super IO Configuration.....	35
	Figure 3.11 Super IO Configuration.....	35
3.3.9	SCH3106 Super IO Configuration	36
	Figure 3.12 Super IO Configuration.....	36
3.3.10	Platform Misc Configuration.....	37
	Figure 3.13 Platform Misc Configuration	37
3.3.11	Embedded Controller Configuration	38
	Figure 3.14 Embedded Controller Configuration	38
3.3.12	Serial Port Console Redirection.....	39
	Figure 3.15 Serial Port Console Redirection	39
3.3.13	CPU PPM Configuration	40
	Figure 3.16 CPU PPM Configuration.....	40
3.4	Chipset.....	41
	Figure 3.17 Chipset Setup.....	41
3.4.1	PCH-IO Configuration.....	42
	Figure 3.18 PCH-IO Configuration	42
3.4.2	System Agent (SA) Configuration.....	43

Ordering Information

Model Number	Description
ARK-2150L-S6A1E	Intel Core i3 3217UE 1.6GHz fanless EBC, VGA+HDMI, 2GbE, 2USB3.0, 4COM
ARK-2150L-S7A1E	Intel Core i7 3517UE 1.7GHz fanless EBC, VGA+HDMI, 2GbE, 2USB3.0, 4COM
ARK-2150F-S6A1E	Intel Core i3 3217UE 1.6GHz fanless EBC, VGA+HDMI+DVI-D, 4GbE, 3USB3.0, 4COM
ARK-2150F-S7A1E	Intel Core i7 317UE 1.6GHz fanless EBC, VGA+HDMI+DVI-D, 4GbE, 3USB3.0, 4COM

Optional Accessories

For ARK-2150L

Part Number	Description
1757003934	AC-to-DC Adapter, DC 12V/5A 60W, 0 ~ 40° C for Home and Office Use
1702002600	Power cable 3-pin 180 cm, USA type
1702031801	Power cable 3-pin 180 cm, UK type
1702002605	Power cable 3-pin 180 cm, Europe type
1700000237	Power cable 3-pin 180 cm, PSE
9666K10000E	DIN-rail mounting kit
1960025333N00N	VESA mounting kit

For ARK-2150F

Part Number	Description
1757003659	AC-to-DC Adapter, DC19 V/3.42 A 65 W, with Phoenix Power Plug, 0 ~ 40° C for Home and Office Use
1700001947	Power cable 2-pin 180 cm, USA for ARK-338X
1700001948	Power cable 2-pin 180 cm, Europe for ARK-338X
1700001949	Power cable 2-pin 180 cm, UK for ARK-338X
1700009001	2-Pole Phoenix to DC-Jack Power cable
9666K10000E	DIN-rail mounting kit
1960025333N00N	VESA mounting kit

Chapter 1

General Introduction

This chapter gives background information on ARK-2150 series.

1.1 Introduction

ARK-2150, an intelligent, fanless embedded system powered by Intel Core i3 3217UE / i7 3517UE Dual Core high performance processor with multiple I/O interface. ARK-2150 is the first one high performance product in ARK-2000 series. The new generation Intel Core i processor brings 15% improvement on processing power and 60% on 3D graphics performance than previous generation Intel Core i processors. These high performance platforms provide energy-efficient and environmentally responsible solutions, and serve applications targeted at surveillance, machine automation, kiosks, and medical imaging; and they operate reliably in -20 ~ 60° C environments!

Rugged & Multifunctional Design

ARK-2150 is powered by Intel Core i3 3217UE 2.6GHz / i7 3517UE 1.7GHz dual core processors in an Advantech, rugged-design embedded box PC. All models are fanless, and highlight various quality features including wide-input power supplies from 12V to 24V, wide temperature range -20 ~ 60° C, diverse expandability options, and structural strengthening. ARK-2150 enlarges the surface of the top cover and conductive cylinder to create maximum cooling effects for optimized cooling efficiency. It also provides rich I/O interfaces: up to 4 x Intel GbEs, 3 x USB 3.0, 4ch isolated digital input, 4ch isolated digital output, and supports high capacity 2.5" HDD up to 1 TB. The RS-232/422/485 COM port mode can easily be changed via BIOS setting.

Multiple Display Support

ARK-2150 supports multiple display types: VGA, HDMI/Display Port or DVI-D display. HDMI and Display Port are designed in the same connector. It can support different panels by changing external cables. The graphic engine is Intel HD Graphics 4000 with DXVA (full AVC/VC1/MPEG2 Hardware Acceleration), OpenGL* 3.0 and DirectX 11 support. ARK-2150 supports triple independent display.

Built in Intelligent Management Tools - Advantech iManager & SUSIAccess

Advantech iManager provides a valuable suite of programmable APIs such as multi-level watchdog, hardware monitor, system restore, and other user-friendly interface. iManager is an intelligent self-management cross platform tool that monitors system status for problems and takes action if anything is abnormal. iManager offers a boot up guarantee in critical, low temperature environments so systems can automatically recover when voltages dip. iManager makes the whole system more reliable and more intelligent. ARK-2150 also supports Advantech's own SUSIAccess, which provides easy remote management so users can monitor, configure, and control a large number of terminals to make maintenance and system recovery simpler.

1.2 Product Features

1.2.1 General

- **CPU:** Intel Core Processor i3 3217UE 1.6GHz / i7 3517UE 1.7GHz
- **System Chipset:** Intel QM77 I/O Controller
- **BIOS:** AMI 64-Mbit SPI Flash BIOS
- **System Memory:** DDR3 1600MHz or DDR3L 1333MHz up to 8GB
- **Watchdog Timer:** Single chip Watchdog 255-level interval timer, setup by software
- **I/O Interface:**
 - 2 x RS232, 2 x RS232/422/485 (ARK-2150L)
 - 4 x RS-232/422/485 (ARK-2150F)
- **USB:**
 - 2 x USB 3.0 and 4 USB 2.0 compliant ports (ARK-2150L)
 - 3 x USB 3.0 and 3 USB 2.0 compliant ports (ARK-2150F)
- **Audio:** High Definition Audio (HD), Line-in, Line out, Mic-in
- **DIO:** 8-bit digital input/output (ARK-2150L);
4-ch isolate digital input and 4-ch isolate digital output with 2.5KV isolation (ARK-2150F)
- **Storage:** 1 x high capacity 2.5" SATA HDD (up to 12.5mm height) and 1 x mSATA
- **Expansion Interface:** Supports 2 x full-size Mini-PCIe (one supports mSATA and the other with SIM holder) and 1 x half-size Mini-PCIe
- **Software API:** Advantech iManager and SUSIAccess - Remote Device Management technology

1.2.2 Display

- **Controller:** Intel HD Graphics 4000
- **Resolution:**
 - VGA: Supports up to 2048x1536 with 32-bit color at 75 Hz
 - HDMI/Display Port: HDMI interface supports the HDMI 1.4a specification with audio up to 1920x1200 at 60 Hz. DisplayPort interface supports the DisplayPort* 1.1a specification with audio up to 2560x1600 at 60 Hz.
 - DVI-D: Supports DVI-D, up to 1920 x 1200 (ARK-2150F only)
- **Dual Display:**
 - VGA+HDMI/DP, VGA+DVI-D, HDMI/DP+DVI-D
- **Triple Display:**
 - VGA+HDMI/DP+DVI-D

1.2.3 Ethernet

- **Chipset:**
 - LAN1 Intel 82579LM,
 - LAN2 Intel 82583V
 - LAN3 and LAN4: Intel 82583V (ARK-2150F only)
- **Speed:** 1000 Mbps
- **Interface:** 4 x RJ45
- **Standard:** Compliant with IEEE 802.3, IEEE 802.3u, IEEE 802.3x, IEEE 802.3y, IEEE 802.ab.

1.3 Chipset

1.3.1 Functional Specification

1.3.1.1 Processor

Processor	Intel Corei3 3217UE 1.6GHz / Core i7 1.7 GHz with 3MB/4MB L2 cache Manufacturing Technology:22nm
Memory	Supports DDR3 1600 MHz or DDR3Š 1333MHz up to 8 GB 1 x 204-pin SODIMM socket type

1.3.1.2 Chipset

Internal Graphics Features	<ul style="list-style-type: none">■ DirectX 11 and OpenGL 3.0■ Display Part 1.1, HDMI 1.3a■ Supports HDCP 1.3■ Intel Display Power saving technology 6.0■ SGXS45 Power VR Core 400/640 MHz
Video Accelerator	<ul style="list-style-type: none">■ HW accelerated Media Decode: AVC/H.264, VC-1, MPEG-2■ HW accelerated Media Encode: AVC/H.264, MPEG-2
SATA Interface	Intel QM77 chip supports: <ul style="list-style-type: none">■ Supports several optional sections of Serial ATA III■ Supports SATA transfers to 600 Mbytes/sec.■ Integrated AHCI controller■ Supports mSATA socket
USB Interface	Intel QM77 chip supports: <ul style="list-style-type: none">■ xHCI Host Controller, supporting SuperSpeed USB 3.0 ports■ Two EHCI Host Controllers, supporting HighSpeed USB 2.0 ports■ Supports wake-up from sleeping states S1–S4■ Supports legacy Keyboard/Mouse software■ Maximum 500mA for each USB port
Power Management	Intel QM77 chip supports: <ul style="list-style-type: none">■ Supports ACPI 4.0a■ ACPI-defined power states (processor driven C states)■ ACPI Power Management Timer■ SMI# generation
BIOS	Intel QM77 chip supports: <ul style="list-style-type: none">■ AMI 64-Mbit EFI Flash BIOS via SPI

1.3.1.3 Others

	<p>ITE 8760E & SMSC SCH3106 supports:</p> <ul style="list-style-type: none"> ■ Up to 4 serial ports. ■ Supports IRQ Sharing among serial ports under Microsoft Windows OS <p>ARK-2150L</p> <ul style="list-style-type: none"> ■ COM1, COM2: Supports to RS-232 ■ COM3, COM4: Supports RS-232/422/485, and change mode via BIOS setting. <p>Serial ports</p> <p>** COM3, COM4 RS-485 support Auto flow control.</p> <p>ARK-2150F</p> <ul style="list-style-type: none"> ■ COM1 ~ COM4: Supports RS-232/422/485 and change mode under BIOS setting <p>** COM1 ~ COM4 RS-485 supports Auto flow control.</p> <p>COM connector: D-SUB CON. 9P</p>
<p>Ethernet</p>	<p>LAN1 Intel 82579LM, LAN2 Intel 82583V LAN3 Intel 82583V, LAN4 Intel 82583V (ARK-2150F only)</p> <ul style="list-style-type: none"> ■ Compliant with IEEE 802.3, IEEE 802.3u, IEEE 802.3x, IEEE 802.3y, IEEE 802.ab. ■ Support 10/100/1000 Mbps. <p>LAN Connectors: Phone Jack RJ45 8P 90D(F)</p>
<p>Audio</p>	<p>Audio Codec: Realtek ALC892:</p> <ul style="list-style-type: none"> ■ Compliant with HD Audio specifications ■ Supports 16/20/24-bit DAC and 16/20/24-bit ADC resolution ■ Supports: Speak-out, Line-in, Mic-in <p>Audio Connectors: Ear Phone Jack * 3</p>

ITE 8518E or PCA9554 supports:**ARK-2150L:**

- 9 I/O pins with one ground pin
- 5V tolerance I/Os.
- *ARK-2150L: 9 pins DSUB 9 connector

ARK-2150F:**Isolated Digital Input**

- Number of Channel: 4
- Optical Isolation: 2,500 VDC
- Opto-isolator response time: 25µs
- Input Voltage: VIH (max.) 30 VDC
VIH (min.) 5 VDC
VIL (max.) 2 VDC
- Input Current: 5 VDC 1.4 mA (typical)
12 VDC 3.9 mA (typical)
24 VDC 8.2 mA (typical)
30 VDC 10.3 mA (typical)

DIO**Isolated Digital Output**

- Number of Channel: 4
- Optical Isolation: 2,500 VDC
- Output Voltage: Open collector 5 to 40 VDC
- Sink Current: 200 mA max./channel
- *ARK-2150F: 10 pins phoenix connector

DIO Connectors:

- ARK-2150L: 9 pins DSUB 9 connector
- ARK-2150F: 10 pins phoenix connector

Battery backup ■ BATTERY 3V/210 mAh with WIRE x 1

1.3.2 iManager

iManager

Sequence control	Supported
DIO	8-bit programmable DIO
Watchdog timer	Multi Level WDT (set by Advantech iManager) Programmable 1-255 sec / min
Hardware monitor	CPU Temperature / input Current / input Voltage
Power saving	Deep sleep S5 mode / Smart Fan / Back light control
System information	Running HR / Boot record

1.4 Mechanical Specifications

1.4.1 Dimensions

264.5[10.41] x 133.0[5.24] x 75.1[2.96] (Unit: mm [Inch])

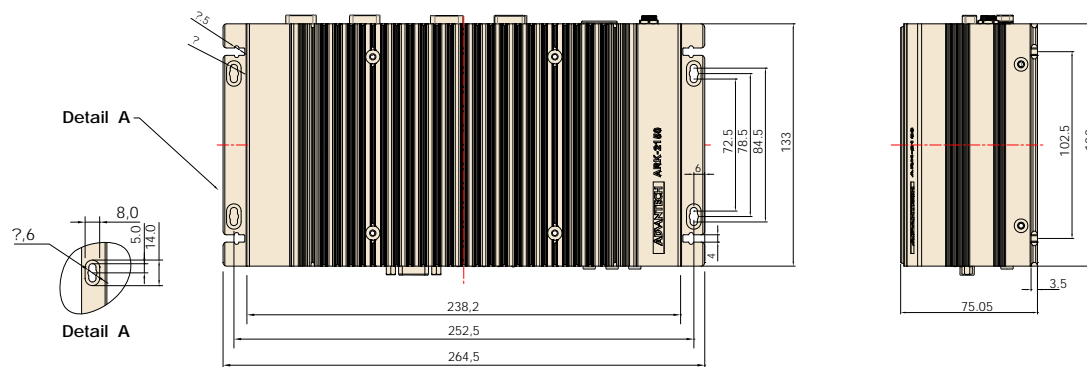

Figure 1.1 ARK-2150 Mechanical dimension drawing

1.4.2 Weight

2.8kg (6.17lb)

1.5 Power Requirement

1.5.1 System Power

- **Minimum power input:**
 - ARK-2150L: DC12 V 4 A
 - ARK-2150F: DC12 V - 24 V, 4 A-2 A

1.5.2 RTC Battery

- Lithium 3 V/210 mAh

1.6 Environment Specification

1.6.1 Operating Temperature

- With Industrial Grade SSD/Cfast: -20 ~ 60° C (-4~140° F), with air flow, speed=0.7 m/sec
- With 2.5-inch hard disk 0 to 45° C (32~113° F), with air flow, speed=0.7 m/sec

1.6.2 Relative Humidity

- 95% @ 40° C (non-condensing)

1.6.3 Storage Temperature

- -40 ~ 85° C (-40 ~ 185° F)

1.6.4 Vibration during Operation

- When system is equipped with SSD/mSATA: 5Grms, IEC 60068-2-64, random, 5 ~ 500 Hz, 1hr/axis, x,y,z 3 axes.

1.6.5 Shock during Operation

- When system is equipped with SSD/mSATA: 50G, IEC 60068-2-27, half sine, 11 ms duration.

1.6.6 Safety

- UL, CCC, BSMI

1.6.7 EMC

- CE, FCC, CCC, BSMI

Chapter 2

H/W Installation

This chapter introduces external IO and the installation of ARK-2150 hardware.

2.1 Introduction

The following sections show the internal jumpers setting and the external connectors pin assignment for application.

2.2 Jumpers

2.2.1 Jumper Description

You may configure ARK-2150 to match the needs of your application by setting jumpers. A jumper is a metal bridge used to close an electric circuit. It consists of two metal pins and a small metal clip (often protected by a plastic cover) that slides over the pins to connect them. To close a jumper, you connect the pins with the clip. To open a jumper, you remove the clip. Sometimes a jumper will have three pins, labeled 1, 2 and 3. In this case you would connect either pins 1 and 2, or 2 and 3.

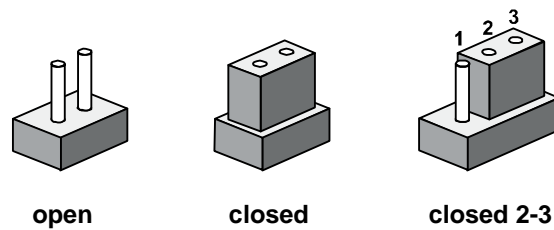

The jumper settings are schematically depicted in this manual as follows.

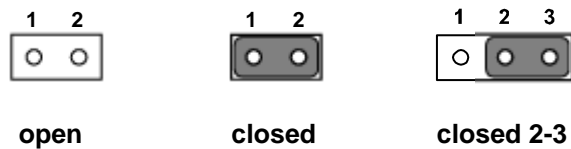

A pair of needle-nose pliers may be helpful when working with jumpers. If you have any doubts about the best hardware configuration for your application, contact your local distributor or sales representative before you make any changes. Generally, you simply need a standard cable to make most connections.

2.2.2 Jumper List

Table 2.1: Jumper List of Main Board

J1	Clear CMOS
J2	Auto Power On Setting
J4	DDR3L select

2.2.3 Jumper Location

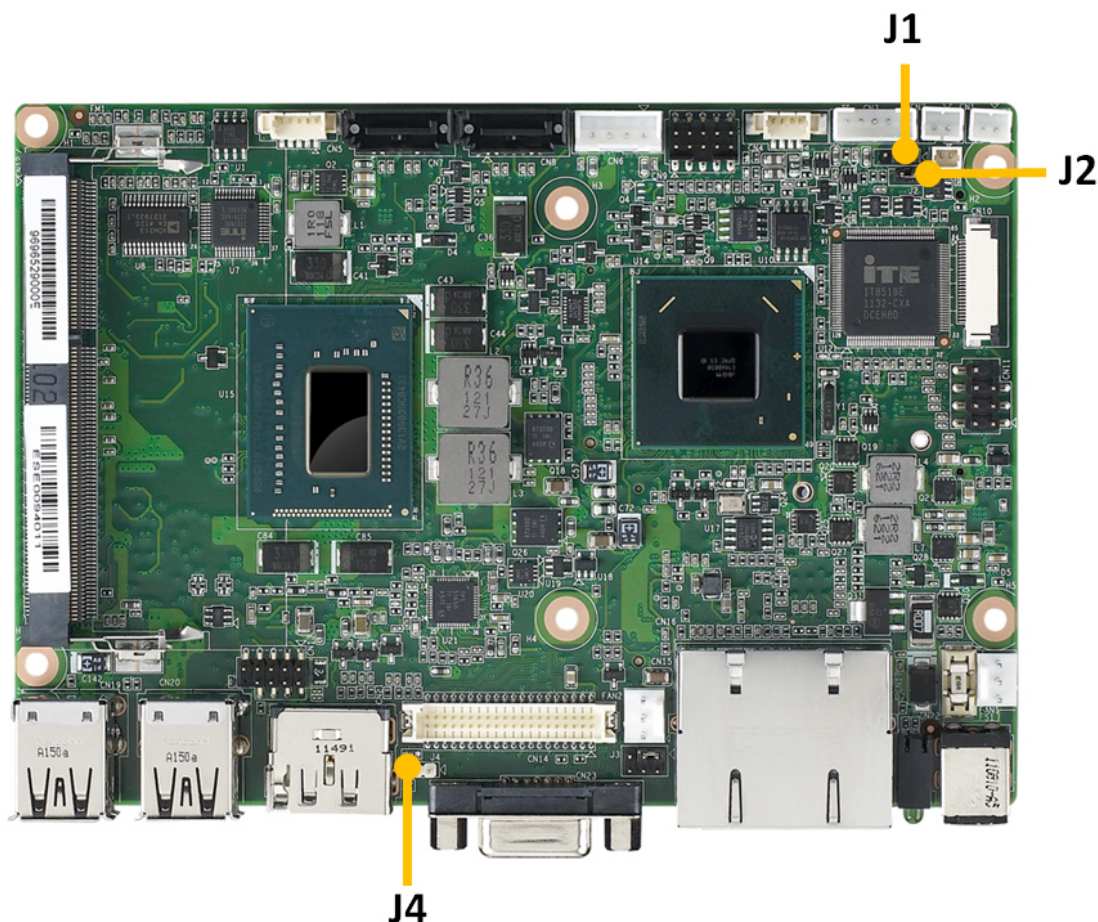

Figure 2.1 Jumper layout

2.2.4 Jumper Setting

At Mother Board

2.2.4.1 Clear CMOS (J1)



Table 2.2: Clear CMOS (JP1)

Setting	Function
(1-2)*	Normal (default)

Table 2.2: Clear CMOS (JP1)

(2-3)	Clear CMOS
-------	------------

2.2.4.2 Auto Power On Setting (J2)

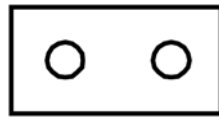

OPEN

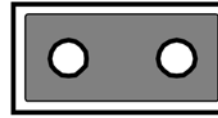

Closed

Table 2.3: Auto Power On Setting (J2)

Setting	Function
NC	Power Button for Power On
(1-2)*	Auto Power On (default)

2.2.4.3 LVDS Panel Power Select (J4)

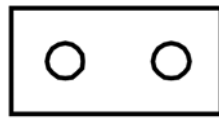

OPEN

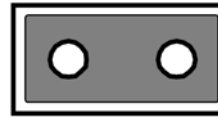

Closed

Table 2.4: LVDS Panel Power Select (J4)

Setting	Function
(Open)*	1.5V for Std. DDR3 (default)
Close	1.35V for DDR3L

2.3 Connectors

2.3.1 ARK-2150 External I/O Connectors

ARK-2150L:

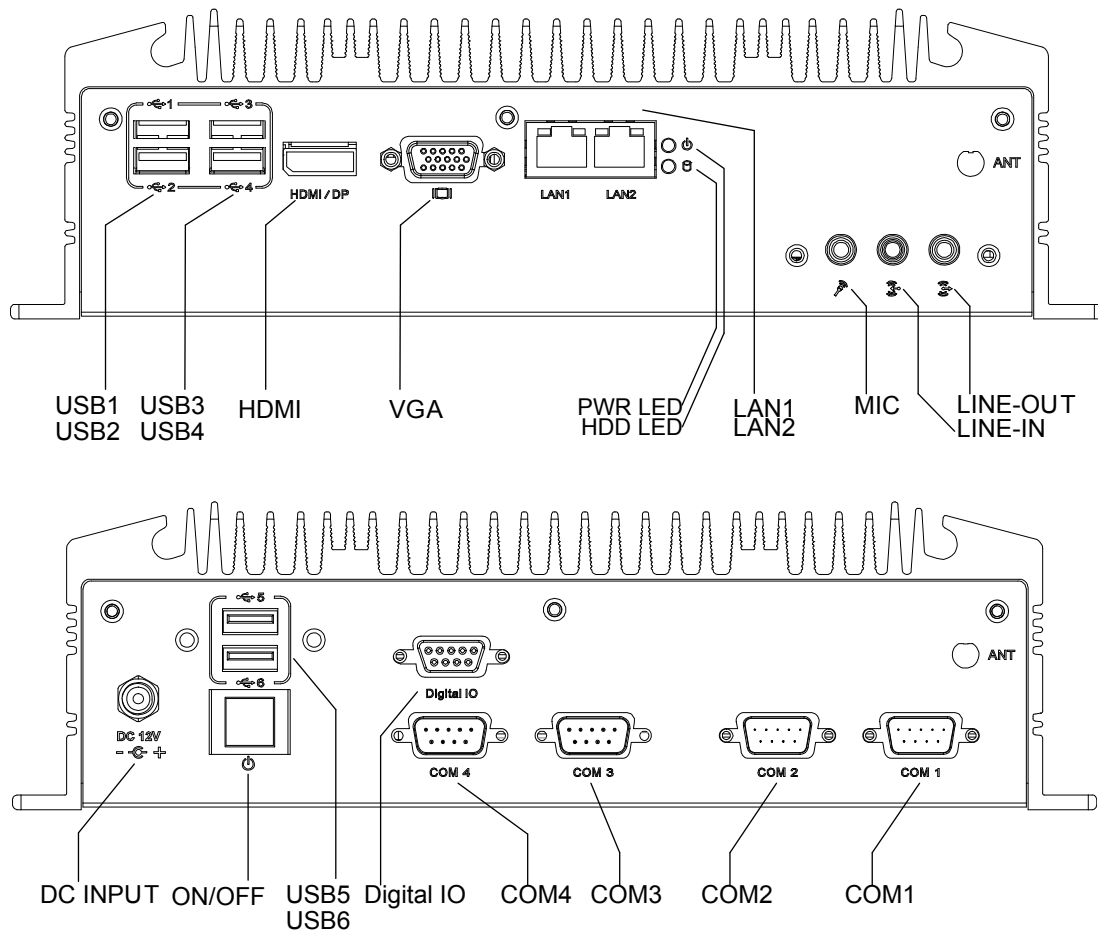
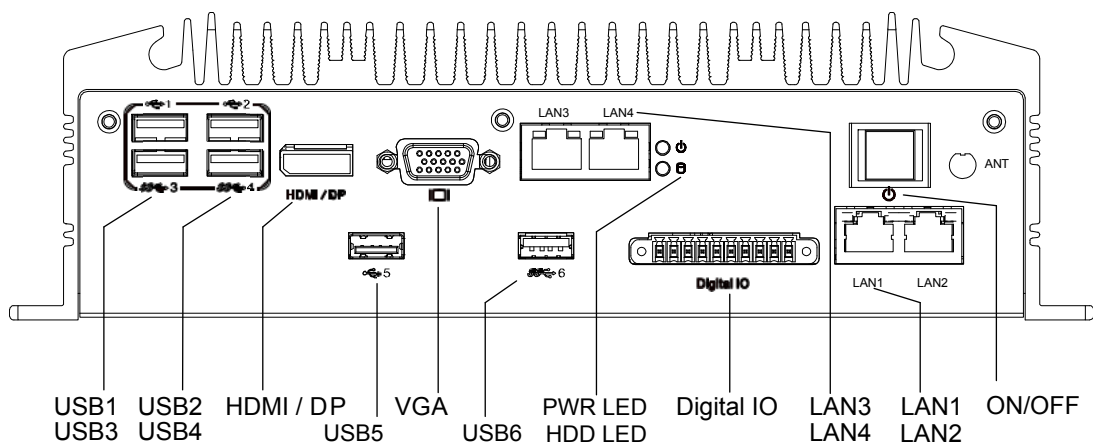

Figure 2.2 ARK-2150L IO connectors drawing

ARK-2150F



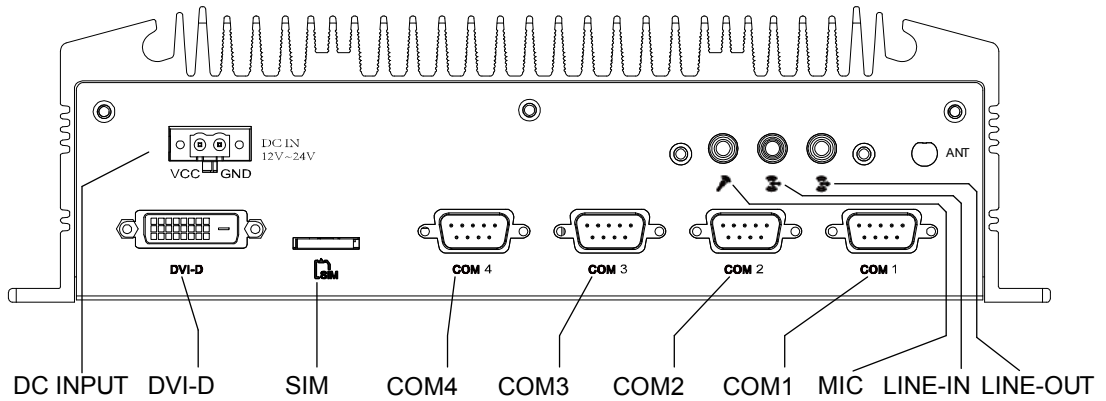

Figure 2.3 ARK-2150F IO connectors drawing

2.3.1.1 COM Connector

ARK-2150 provides up to four D-sub 9-pin connectors, which offers RS-232/422/485 serial communication interface ports. Default setting is RS-232, if you want to use RS-422/485, you just need to change BIOS setting. The BIOS setting of RS-232/422/485 can be found in Chapter 3.3.8 & 3.3.9.

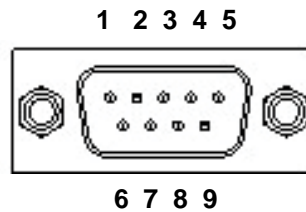

Figure 2.4 COM connector

Table 2.5: COM Connector Pin Assignments

	RS-232	RS-422	RS-485
Pin	Signal Name	Signal Name	Signal Name
1	DCD	Tx-	DATA-
2	RxD	Tx+	DATA+
3	TxD	Rx+	NC
4	DTR	Rx-	NC
5	GND	GND	GND
6	DSR	NC	NC
7	RTS	NC	NC
8	CTS	NC	NC
9	RI	NC	NC

Note! NC represents “No Connection”.



2.3.1.2 Ethernet Connector (LAN)

ARK-2150 is equipped with up to four Ethernet controllers that are fully compliant with IEEE 802.3u 10/100/1000 Mbps CSMA/CD standards. The Ethernet port provides a standard RJ-45 jack connector with LED indicators on the front side to show its Active/Link status (Green LED) and Speed status (Yellow LED).

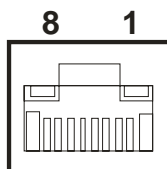

Figure 2.5 Ethernet connector

Table 2.6: Ethernet Connector Pin Assignments

Pin	10/100/1000BaseT Signal Name
1	TX+
2	TX-
3	RX+
4	MDI2+
5	MDI2-
6	RX-
7	MDI3+
8	MDI3-

2.3.1.3 Audio Connector

ARK-2150 offers stereo audio ports by three phone jack connectors of Line_Out, Line_In, Mic_In. The audio chip is controlled by ALC892, and it's compliant with Azalea standard.

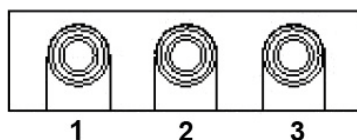

Figure 2.6 Audio connector

Table 2.7: Audio Connector Pin Assignments

Pin	Audio Signal Name
1	Mic_In
2	Line_Out
3	Line_In

2.3.1.4 DIO Connector

ARK-2150L provides one DSUB 9-pin female connector, which offers 8-bit digital input/output communication without isolation. ARK-2150F provides one phoenix 10-pin male connector which offers 4-ch digital input and 4-ch digital output with 2.5KV isolation. The detail pin assignment as below.

ARK-2150L

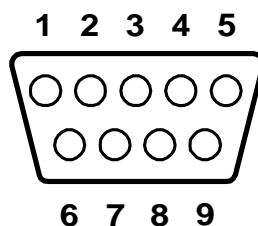

Figure 2.7 DIO Connector (ARK-2150L)

Table 2.8: DIO Connector Pin Assignments (ARK-2150L)

Pin	Signal Name
1	DIO bit0
2	DIO bit1
3	DIO bit2
4	DIO bit3
5	DIO bit4
6	DIO bit5
7	DIO bit6
8	DIO bit7
9	GND

ARK-2150F



Figure 2.8 Isolated DIO connector (ARK-2150F)

Table 2.9: DIO Connector Pin Assignments (ARK-2150F)

Pin	Signal Name
1	Isolated DI0
2	Isolated DI1
3	Isolated DI2
4	Isolated DI3
5	Isolated DO0
6	Isolated DO1
7	Isolated DO2
8	Isolated DO3
9	GND
10	GND

2.3.1.5 USB3.0 Connector

The USB port 3 and 4 of ARK-2150L and USB port 3, 4, and 5 of ARK-2150F support USB3.0 interface, which give complete Plug & Play and hot swapping for up to 127 external devices. The USB interface complies with USB UHCI, Rev. 3.0 compliant. Please refer to Table. 2.7 for its pin assignments. USB 3.0 connectors contain legacy pins to interface to USB 2.0 devices, and a new set of pins for USB 3.0 connectivity (both sets reside in the same connector).



Figure 2.9 USB3.0 Connector

Table 2.10: USB 3.0 Connector

Pin	Signal name	Pin	Signal name
1	+5V	2	USB_data-
3	USB_data+	4	GND
5	SSRX-	6	SSRX+
7	GND	8	SSTX-
9	SSTX+		

2.3.1.6 USB2.0 Connector

ARK-2150 provides up to four USB2.0 interface connectors, which give complete Plug & Play and hot swapping for up to 127 external devices. The USB interface complies with USB UHCI, Rev. 2.0 compliant. The USB interface can be disabled in the system BIOS setup. Please refer to Table. 2.7 for its pin assignments. The USB connectors are used to connect any device that conforms to the USB interface. Most digital devices conform to this standard. The USB interface supports Plug and Play.

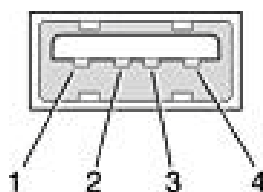
**Figure 2.10 USB2.0 connector****Table 2.11: USB2.0 Connector**

Pin	Signal name	Pin	Signal name
1	+5V	2	USB_data-
3	USB_data+	4	GND

2.3.1.7 VGA Connector

The ARK-2150 provides a high resolution VGA interface connected by a D-sub 15-pin connector to support a VGA CRT monitor. It supports display resolutions of up to 1900 x 1200.

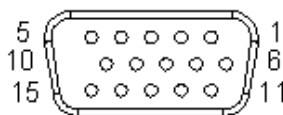
**Figure 2.11 VGA Connector****Table 2.12: VGA Connector Pin Assignments**

Pin	Signal Name	Pin	Signal Name
1	Red	2	Green
3	Blue	4	NC
5	GND	6	GND
7	GND	8	GND
9	NC	10	GND
11	NC	12	NC

13	H-SYNC	14	V-SYNC
15	NC		

2.3.1.8 HDMI / Display Port Connector

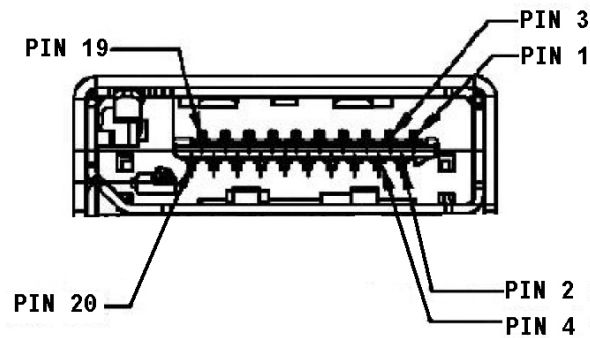

Figure 2.12 HDMI / Display Port Connector

Table 2.13: HDMI / Display Port Connector Pin Assignments

Pin	Signal Name	Pin	Signal Name
1	TMDS_Data2+/ DP_Data0+	2	GND
3	TMDS_Data2-/ DP_Data0-	4	TMDS_Data1+/ DP_Data1+
5	GND	6	TMDS_Data1-/ DP_Data1-
7	TMDS_Data0+/ DP_Data2+	8	GND
9	TMDS_Data0-/ DP_Data2-	10	TMDS_Clock+/ DP_Data3+
11	GND	12	TMDS_Clock-/ DP_Data3-
13	NC	14	NC
15	SCL/ AUX_CH+	16	SDA/ GND
17	DDC GND/ AUX_CH-	18	+5V/ Hot plug detect
19	Hot plug detect/ Return	20	DP_PWR

2.3.1.9 Power Input Connector

ARK-2150L comes with a lockable DC Jack that carries 12 VDC external power input and ARK-2150F comes with a two pins header that carries 12 ~ 24 VDC external power input.

ARK-2150L



Figure 2.13 Power Input Connector (ARK-2150L)

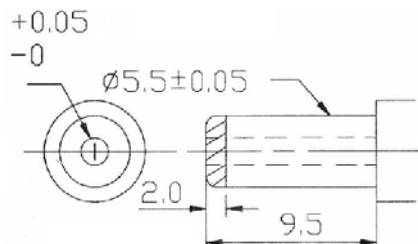

Figure 2.14 Compatible dimension of DC Plug for ARK-2150L

ARK-2150F

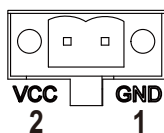

Figure 2.15 Power Input Connector (ARK-2150F)

Table 2.14: Power connector Pin Assignments (ARK-2150F)

Pin	Signal Name
1	GND
2	+12~24 VDC

2.3.1.10 Power ON/OFF Button

ARK-2150 comes with a Power On/Off button, that supports dual functions of Soft Power -On/Off (Instant off or Delay 4 Second), and Suspend.

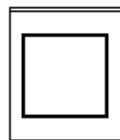

Figure 2.16 Power Button

2.3.1.11 LED Indicators

There are two LEDs on ARK-2150 front metal face plate for indicating system status: PWR LED is for power status; and HDD LED is for HDD & Cfast flash disk status.



Figure 2.17 LED Indicators

2.3.1.12 DVI-D Connector (ARK-2150F only)

ARK-2150F offers a Digital Visual Interface connector by a D-sub 24-pin female DVI-D connector; it's only for digital video signal. This interface supports high-speed, high resolution digital displays.

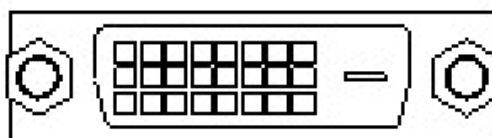

Figure 2.18 DIO Connector

Table 2.15: DVI-D Connector Pin Assignments

Pin	Signal Name	Pin	Signal name
1	TMDS Data 2-	2	TMDS Data 2+
3	TMDS Data 2/4 shield	4	TMDS Data 4-
5	TMDS Data 4+	6	DDC clock
7	DDC data	8	Analog vertical sync

Table 2.15: DVI-D Connector Pin Assignments

9	TMDS Data 1-	10	TMDS Data 1+
11	TMDS Data 1/3 shield	12	TMDS Data 3-
13	TMDS Data 3+	14	+5 V
15	Ground	16	Hot plug detect
17	TMDS data 0-	18	TMDS data 0+
19	TMDS data 0/5 shield	20	TMDS data 5-
21	TMDS data 5+	22	TMDS clock shield
23	TMDS clock+	24	TMDS clock-

2.4 Installation

2.4.1 HDD Installation

1. Unscrew the six screws on the bottom cover.

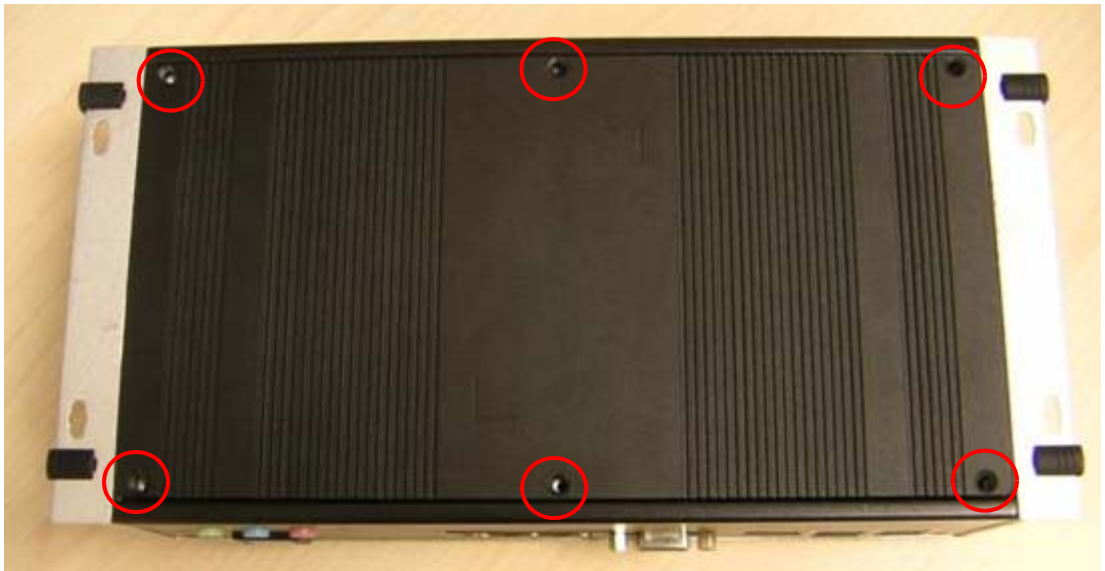

2. Slide the 2.5" SATA HDD into the HDD bay on the bottom cover.



3. Screw the four screws on the side of HDD bracket. The screws are used to fix the HDD on the bracket. (The screws are in the accessory box.)

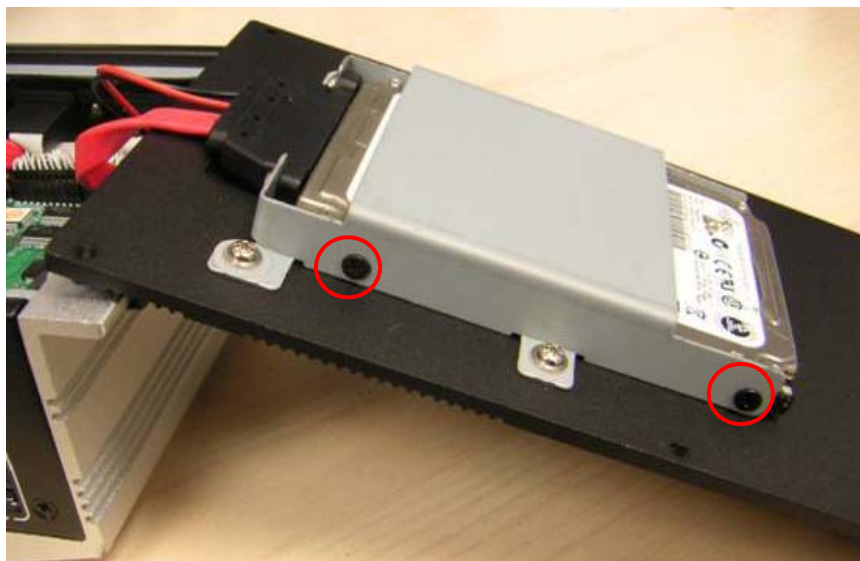

4. Recover the bottom cover and screws.

2.4.2 Memory Installation

1. Unscrew the four screws on the top cover.



2. Unscrew the four screws on the right and left side of top cover



3. Remove the top cover



4. Install DDR3 memory in to the system

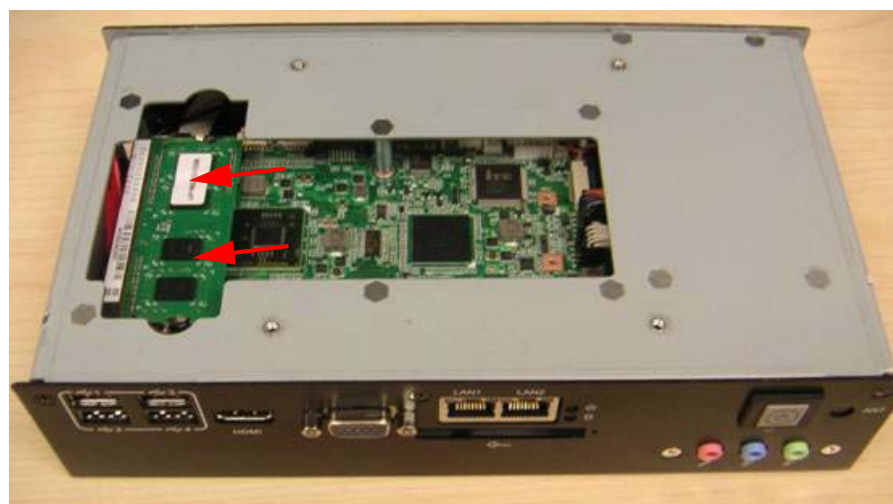

5. Recover the top chassis.

2.4.3 MiniPCle module and mSATA Installation

1. Unscrew the four screws on the top cover.



2. Install miniPCle module or mSATA into the socket.

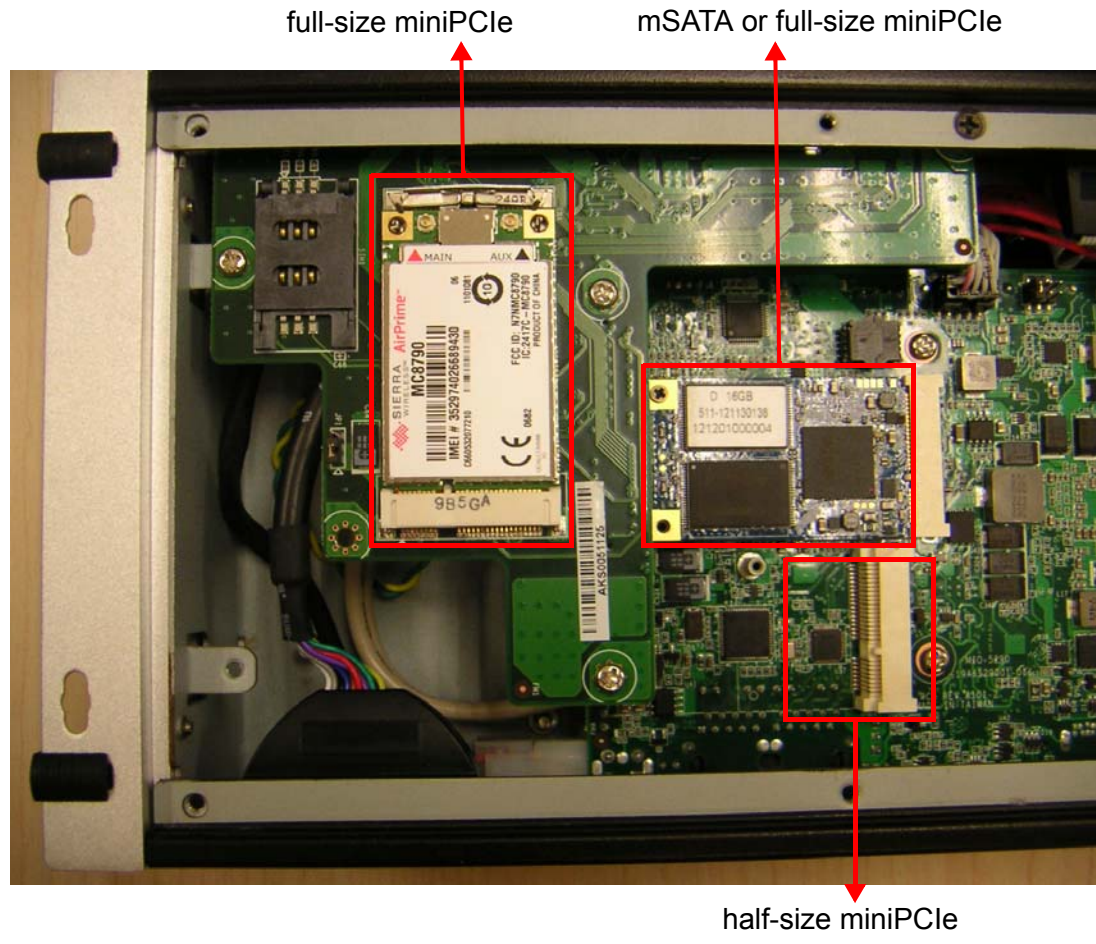

3. Recover the bottom cover and screws.

Chapter 3

BIOS Settings

AMIBIOS has been integrated into many motherboards for over a decade. With the AMIBIOS Setup program, users can modify BIOS settings and control various system features. This chapter describes the basic navigation of the ARK-2150 BIOS setup screens.

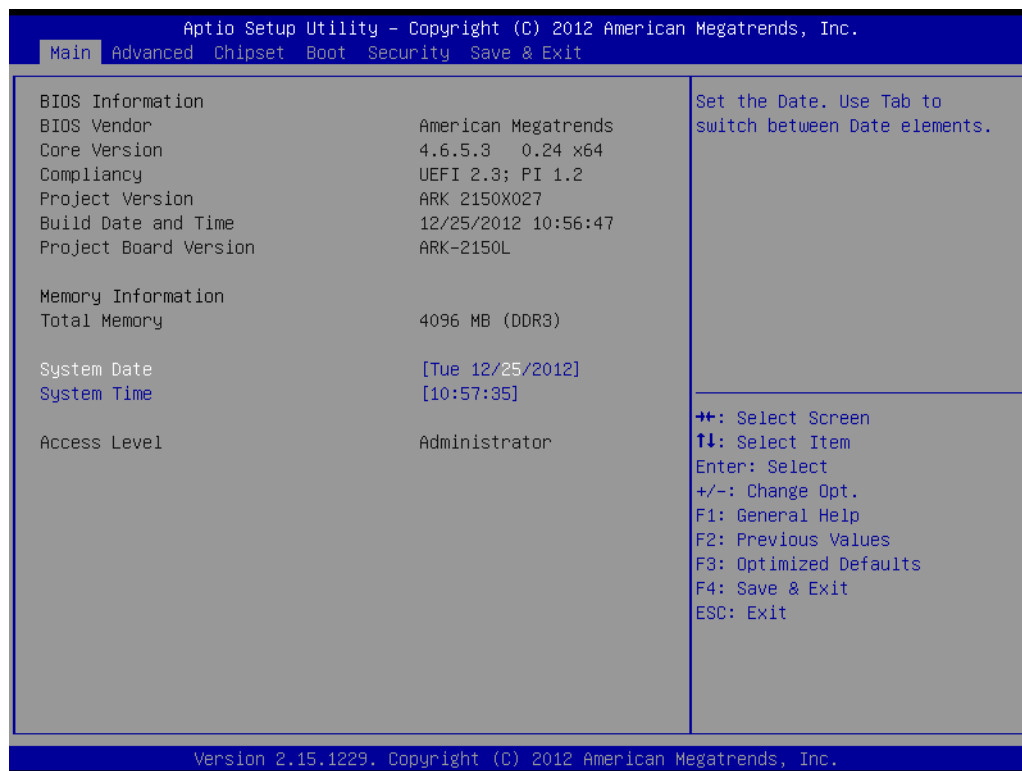

Figure 3.1 Setup program initial screen

AMI's BIOS ROM has a built-in Setup program that allows users to modify the basic system configuration. This information is stored in flash ROM so it retains the Setup information when the power is turned off.

3.1 Entering Setup

Turn on the computer and then press <F2> or to enter Setup menu.

3.2 Main Setup

When users first enter the BIOS Setup Utility, users will enter the Main setup screen. Users can always return to the Main setup screen by selecting the Main tab. There are two Main Setup options. They are described in this section. The Main BIOS Setup screen is shown below.

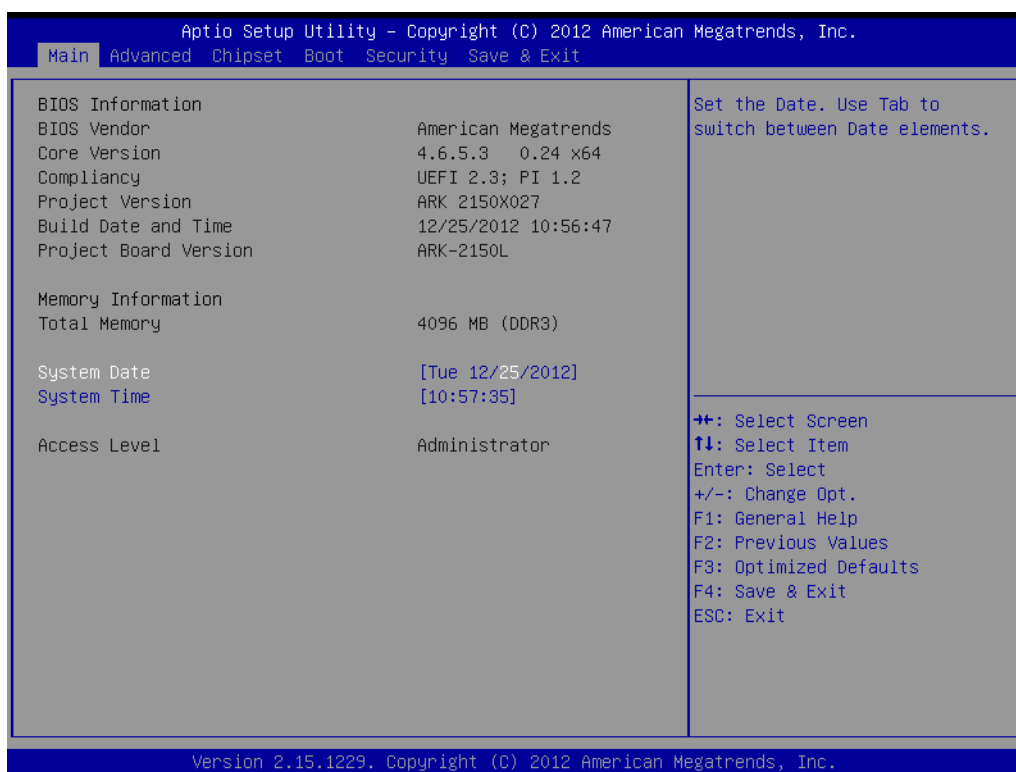

Figure 3.2 Main setup screen

The Main BIOS setup screen has two main frames. The left frame displays all the options that can be configured. Grayed-out options cannot be configured; options in blue can. The right frame displays the key legend.

Above the key legend is an area reserved for a text message. When an option is selected in the left frame, it is highlighted in white. Often a text message will accompany it.

3.2.1 System time / System date

Use this option to change the system time and date. Highlight System Time or System Date using the <Arrow> keys. Enter new values through the keyboard. Press the <Tab> key or the <Arrow> keys to move between fields. The date must be entered in MM/DD/YY format. The time must be entered in HH:MM:SS format.

3.3 Advanced BIOS Features Setup

Select the Advanced tab from the ARK-2150 setup screen to enter the Advanced BIOS Setup screen. Users can select any item in the left frame of the screen, such as CPU Configuration, to go to the sub menu for that item. Users can display an Advanced BIOS Setup option by highlighting it using the <Arrow> keys. All Advanced BIOS Setup options are described in this section. The Advanced BIOS Setup screens are shown below. The sub menus are described on the following pages.

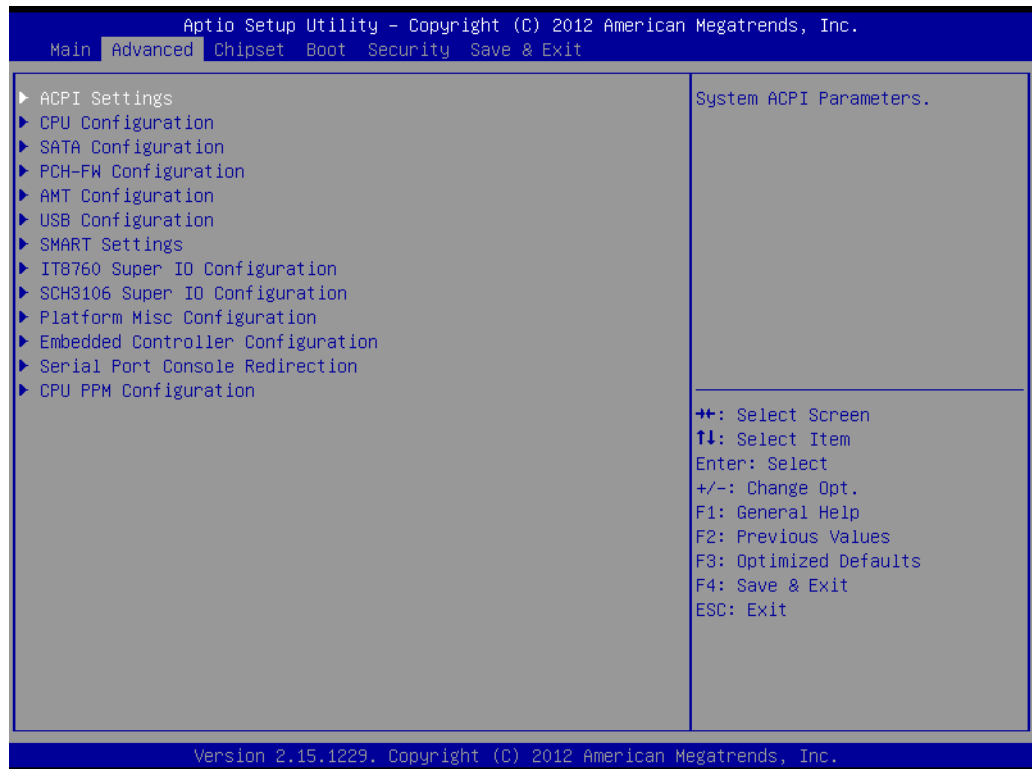

Figure 3.3 Advanced BIOS features setup screen

3.3.1 ACPI Settings

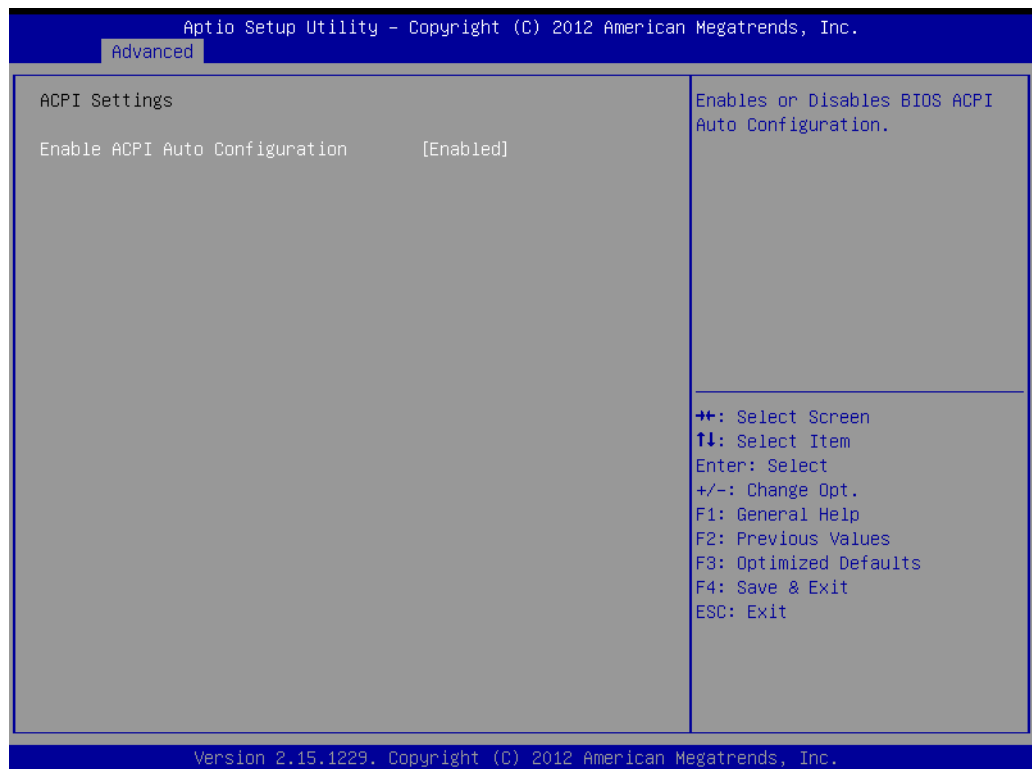

Figure 3.4 ACPI Setting

Enable ACPI Auto Configuration

This item allows users to enable or disable BIOS ACPI auto configuration.

Enable Hibernation

This item allows users to enable or disable hibernation.

ACPI Sleep State

This item allows users to set the ACPI sleep state.

Lock Legacy Resources

This item allows users to lock legacy devices' resources.

S3 Video Repost

This item allows users to enable or disable VBIOS run after S3 resume.

3.3.2 CPU Configuration

Figure 3.5 CPU Configuration

Hyper Threading Technology

This item allows users to enable or disable Intel® Hyper Threading technology.

Active Processor Cores

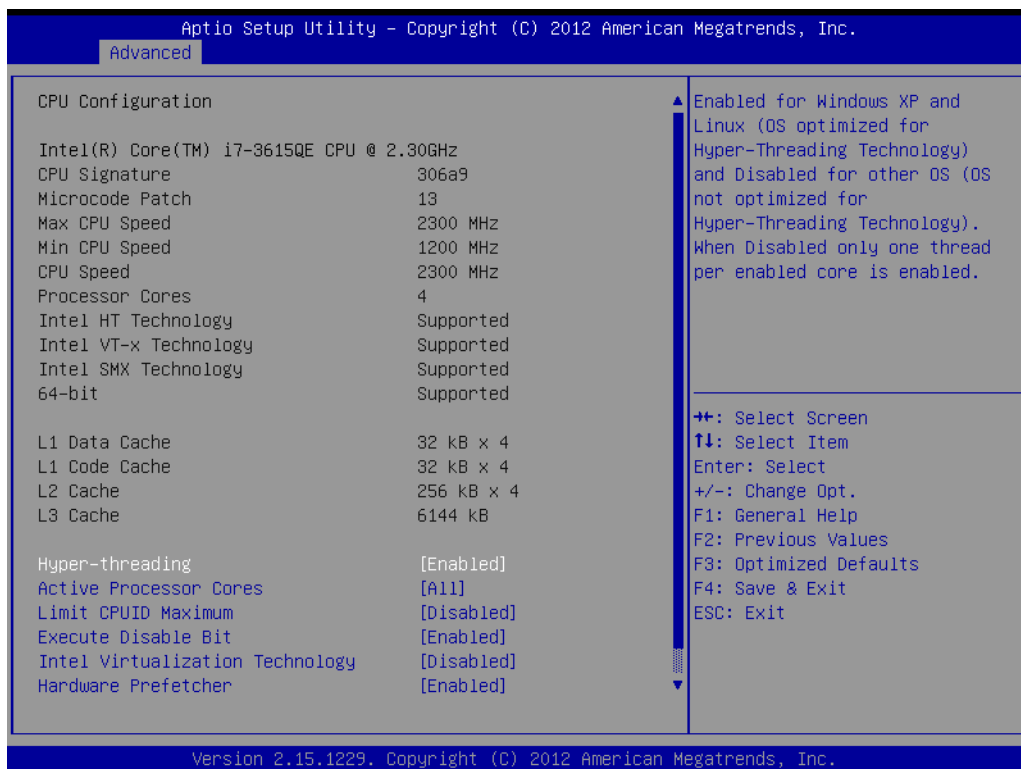
This item allows users to set how many processor cores should be active.

Limit CPUID Maximum

This item allows users to limit the maximum value of CPUID.

Execute Disable Bit

This item allows users to enable or disable the No-Execution page protection technology.

Intel Virtualization Technology

This item allows users to enable or disable the intel virtualization technology.

Hardware Prefetcher

This item allows users to enable or disable the hardware prefetcher feature.

Adjacent Cache Line Prefetch

This item allows users to enable or disable the adjacent cache line prefetch feature.

3.3.3 SATA Configuration

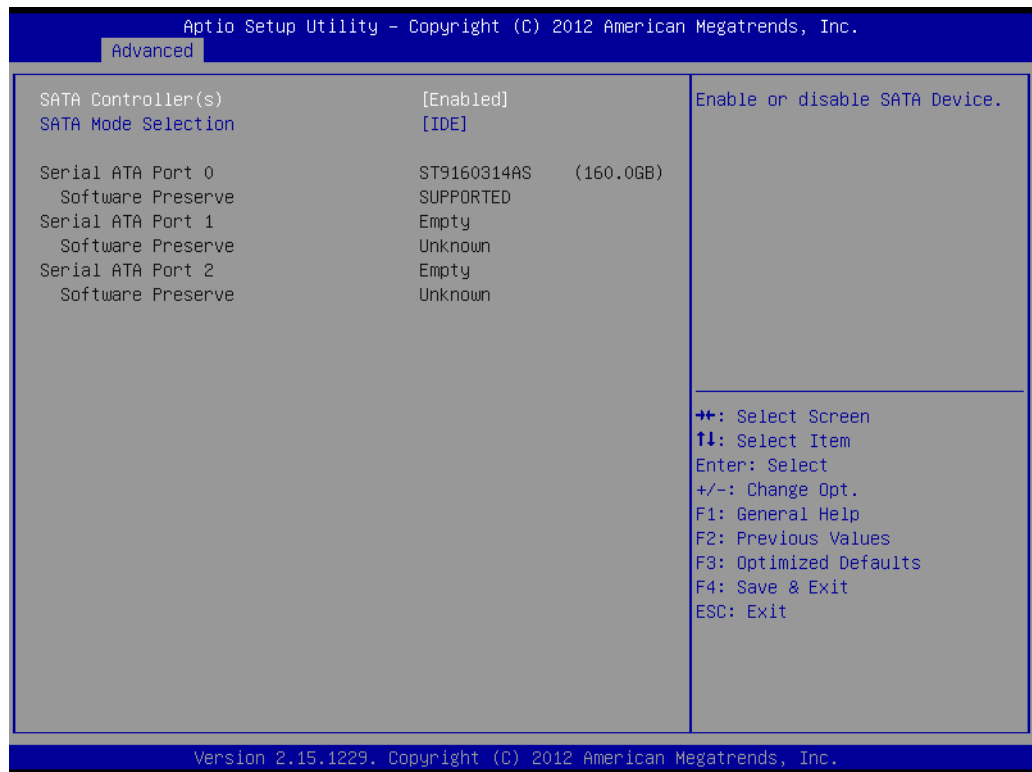

Figure 3.6 SATA Configuration

SATA Controller(s)

This item allows users to enable or disable the SATA controller(s).

SATA Mode Selection

This item allows users to select mode of SATA controller(s).

3.3.4 PCH-FW Configuration

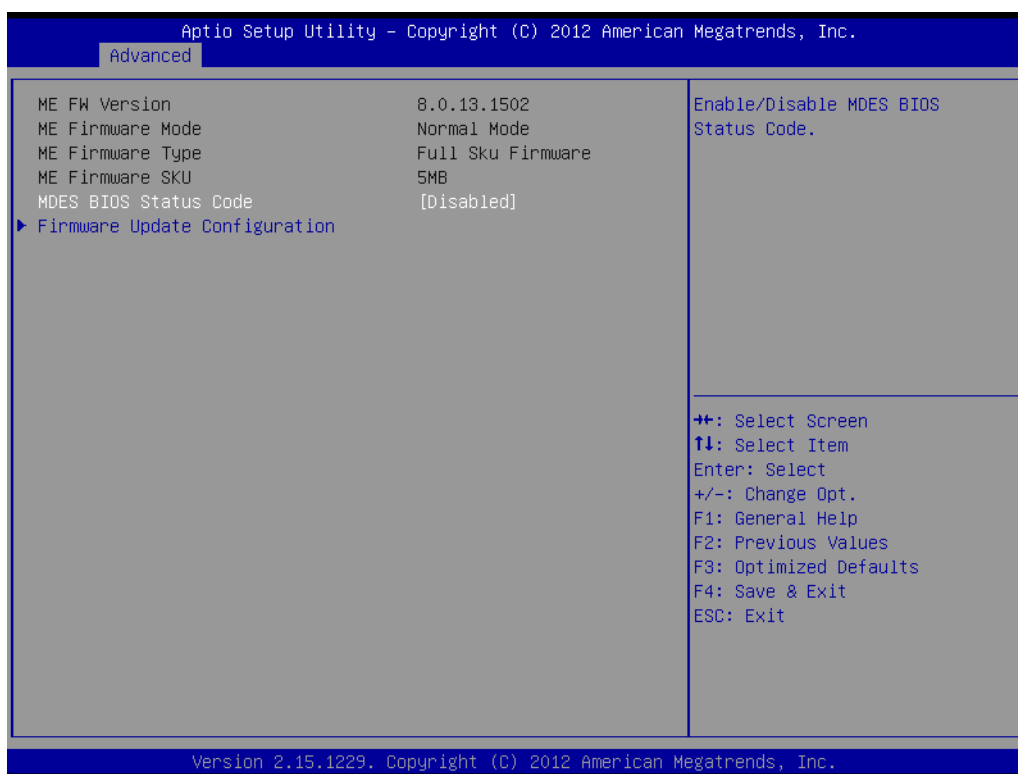

Figure 3.7 PCH-FW Configuration

MDES BIOS Status Code

This item allows users to enable or disable MDES BIOS Status Code function.

Firmware Update Configuration

This item allows users to enable or disable ME FW image re-flash function.

3.3.5 AMT Configuration

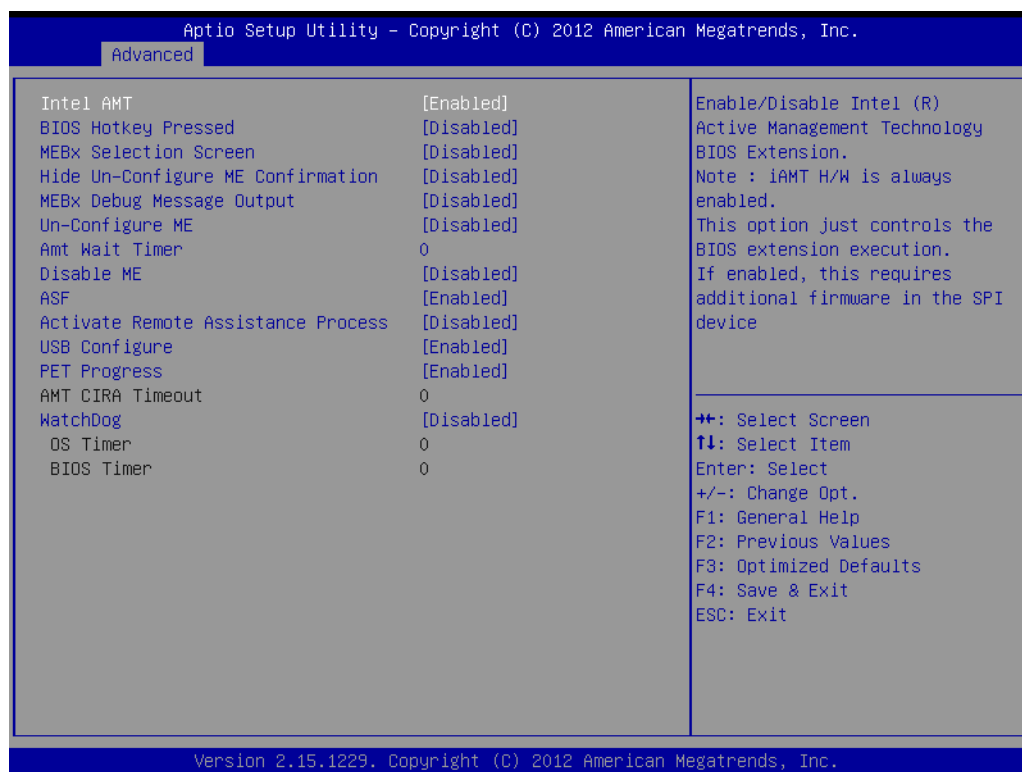

Figure 3.8 AMT Configuration

Intel AMT

This item allows users to enable or disable Intel AMT BIOS extension.

BIOS Hotkey Pressed

This item allows users to enable or disable BIOS hotkey press.

MEBx Selection Screen

This item allows users to enable or disable MEBx selection screen.

Hide Un-Configuration ME Confirmation

This item allows users to hide un-configure ME without password confirmation prompt.

MEBx Debug Message Output

This item allows users to enable or disable MEBx debug message.

Un-Configure ME

This item allows users to un-configure ME without password.

Amt Wait Timer

Set timer to wait before sending ASF_GET_BOOT_OPTIONS.

Disable ME

This item allows users to enable or disable Intel ME.

ASF

This item allows users to enable or disable Alert Specification Format.

Activate Remote Assistance Process

This item allows users to enable or disable trigger CIRA boot.

USB Configure

This item allows users to enable or disable USB configure function.

PET Progress

This item allows users to enable or disable PET events progress to receive PET events or not.

AMT CIRA Timeout

OEM defined timeout for MPS connection to be established.

WatchDog

This item allows users to enable or disable WatchDog Timer.

OS Timer

Set OS watchdog timer.

BIOS Timer

Set BIOS watchdog timer.

3.3.6 USB Configuration

Figure 3.9 USB Configuration

Legacy USB Support

Enable the support for legacy USB. Auto option disables legacy support if no USB devices are connected.

USB3.0 Support

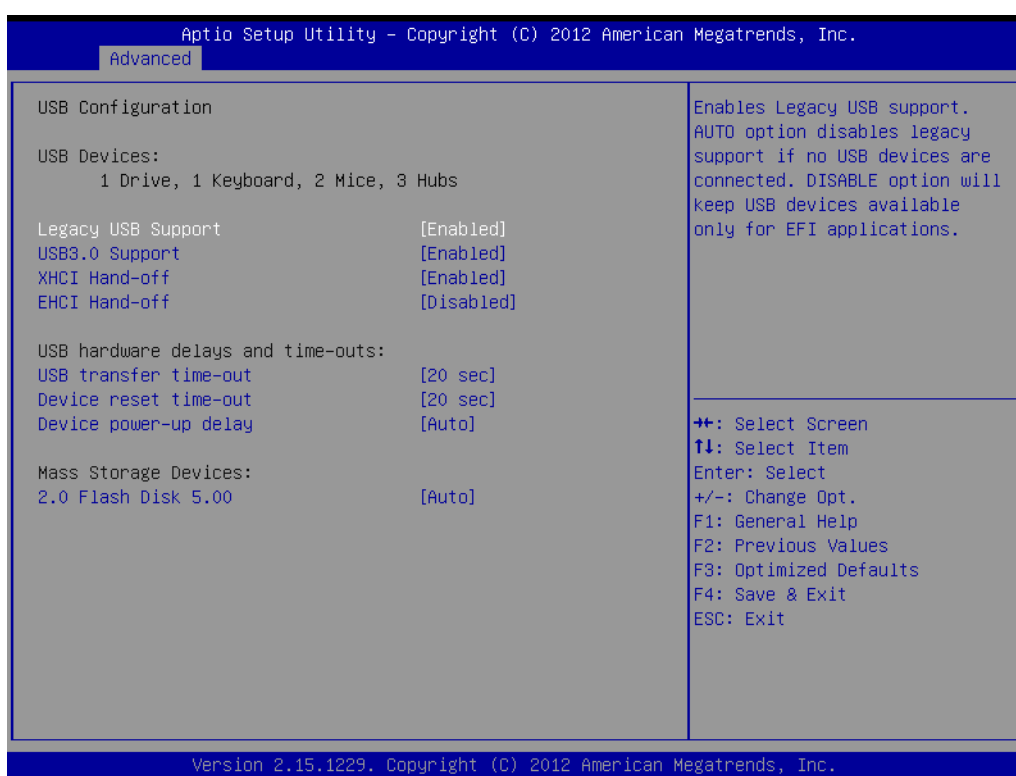
This item allows users to enable or disable USB3.0 support.

XHCI Hand-Off

This is a workaround for the OS without XHCI hand-off support. The XHCI ownership change should claim by XHCI driver.

EHCI Hand-Off

This is a workaround for the OS without EHCI hand-off support. The EHCI ownership change should claim by EHCI driver.

USB transfer time-out

Set the time-out value for Control, Bulk, and Interrupt transfers.

Device reset time-out

Set USB mass storage device Start Unit command time-out value.

Device power-up delay

Set the maximum time of the device will take before it properly reports itself to the Host Controller. 'Auto' uses default value: for a Root port it is 100 ms, for a Hub port the delay is taken from Hub descriptor.

2.0 Flash Disk 5.00

This is a Mass storage device emulation type.

3.3.7 SMART Settings

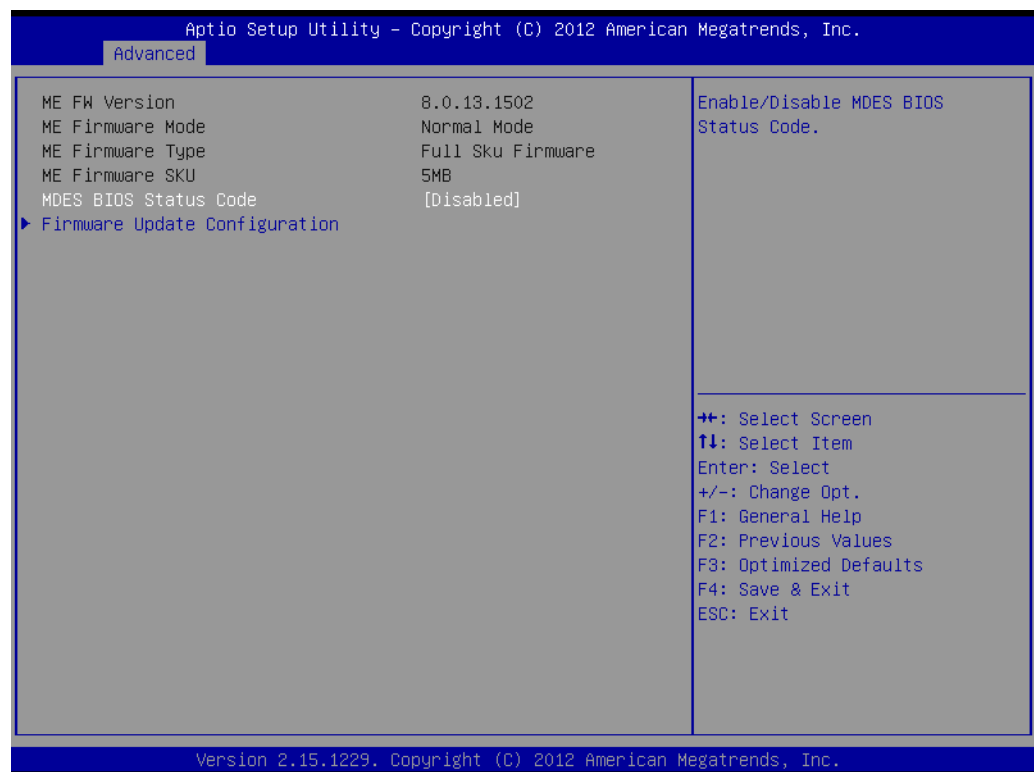

Figure 3.10 SMART Settings

SMART Self Test

This item allows users to enable or disable SMART Self Test.

3.3.8 IT8760 Super IO Configuration



Figure 3.11 Super IO Configuration

3.3.8.1 Serial Port 1 Configuration

Serial Port

This item allows users to enable or disable COM1.

Change Settings

This item allows users to select super I/O device.

3.3.8.2 Serial Port 2 Configuration

Serial Port

This item allows users to enable or disable COM2.

Change Settings

This item allows users to select super I/O device.

3.3.9 SCH3106 Super IO Configuration



Figure 3.12 Super IO Configuration

3.3.9.1 Serial Port 3 Configuration

Serial Port

This item allows users to enable or disable COM3.

Change Settings

This item allows users to select super I/O device.

Device Mode

This item allows users to select Serial Port mode.

Serial interface

This item allows users to select RS-232/422/485. Default by RS-232.

3.3.9.2 Serial Port 4 Configuration

Serial Port

This item allows users to enable or disable COM4.

Change Settings

This item allows users to select super I/O device.

Device Mode

This item allows users to select Serial Port mode.

Serial interface

This item allows users to select RS-232/422/485. Default by RS-232.

3.3.10 Platform Misc Configuration



Figure 3.13 Platform Misc Configuration

Native PCIE Enable

This item allows users to enable or disable native PCIE support feature.

3.3.11 Embedded Controller Configuration

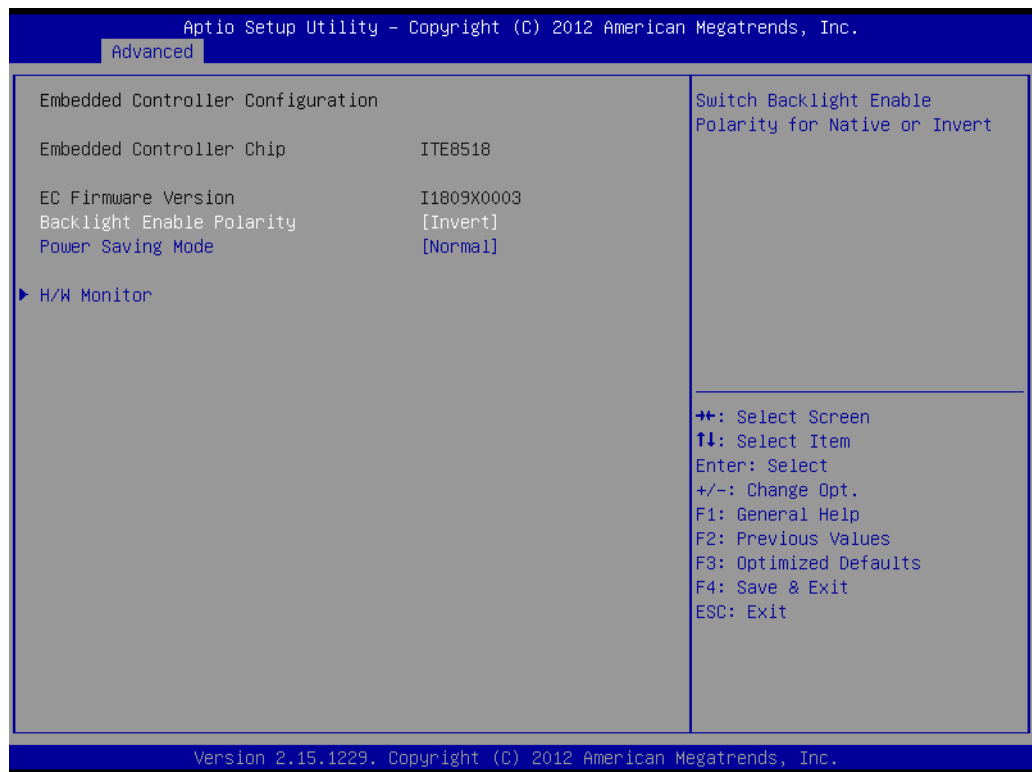

Figure 3.14 Embedded Controller Configuration

Backlight Enable Polarity

This item allows users to set backlight Function.

Power Saving Mode

This item allows users to select ITE8518 power saving mode.

H/W Monitor

This item is show CPU temperature and VBAT / +5V / +12V / +Vcore voltage information.

3.3.12 Serial Port Console Redirection

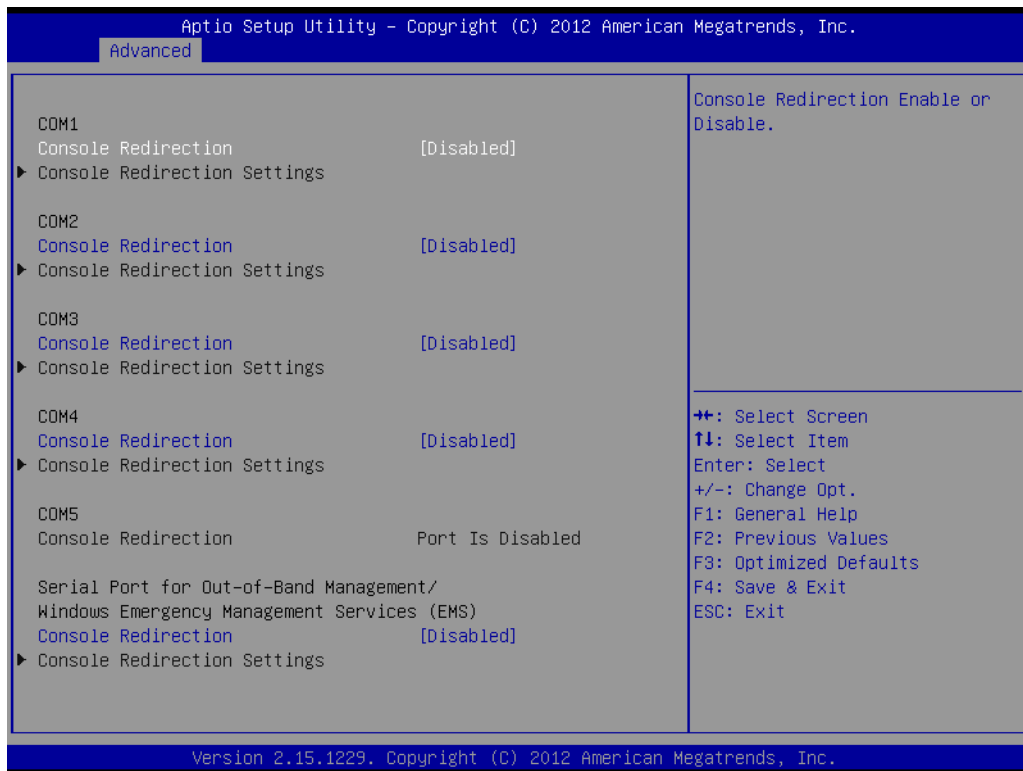

Figure 3.15 Serial Port Console Redirection

Console Redirection

This item allows users to enable or disable console redirection for Microsoft Windows Emergency Management Services (EMS).

Console Redirection Settings

This item allows users to configuration console redirection detail settings.

3.3.13 CPU PPM Configuration

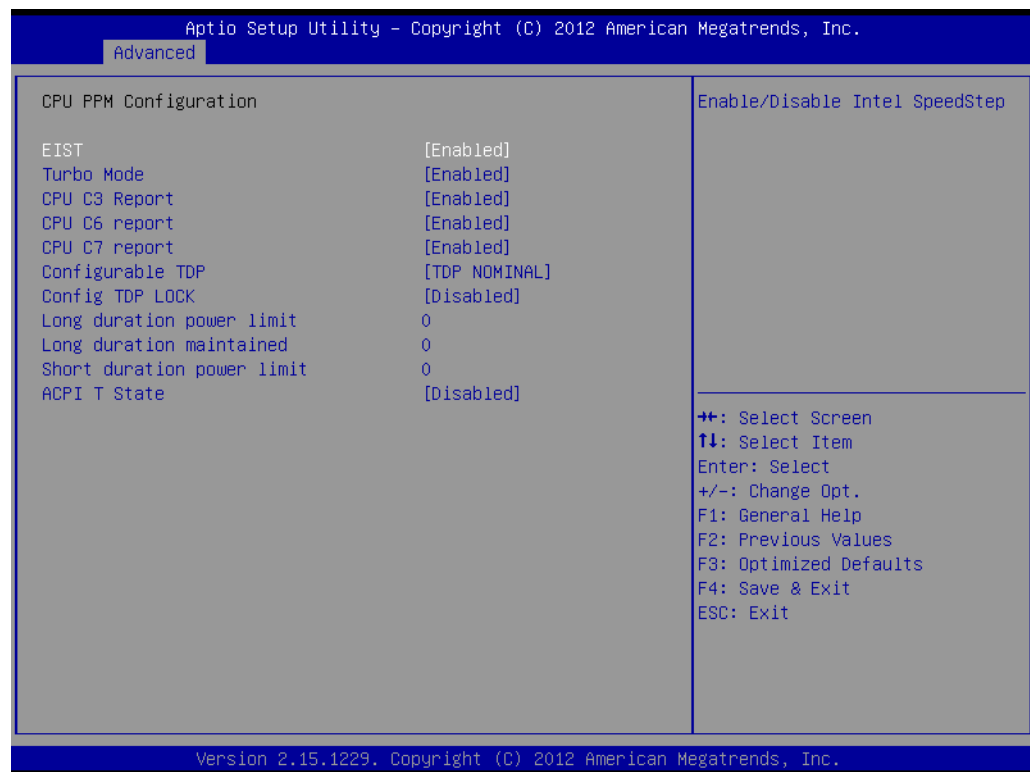

Figure 3.16 CPU PPM Configuration

EIST

CPU runs at its default speed if disabled; CPU speed is controlled by the operating system if enabled.

Turbo Mode

This item allows users to enable or disable turbo mode.

CPU C3/C6/C7 Report

This item allows users to enable or disable CPU C-state support.

Configurable TDP

This item allows users to select TDP levels.

Config TDP LOCK

This item allows users to enable or disable Config TDP LOCK.

ACPI T State

This item allows users to enable or disable ACPI T State.

3.4 Chipset

Select the Chipset tab from the ARK-2150 setup screen to enter the Chipset BIOS Setup screen. You can display a Chipset BIOS Setup option by highlighting it using the <Arrow> keys. All Plug and Play BIOS Setup options are described in this section. The Plug and Play BIOS Setup screen is shown below.



Figure 3.17 Chipset Setup

3.4.1 PCH-IO Configuration

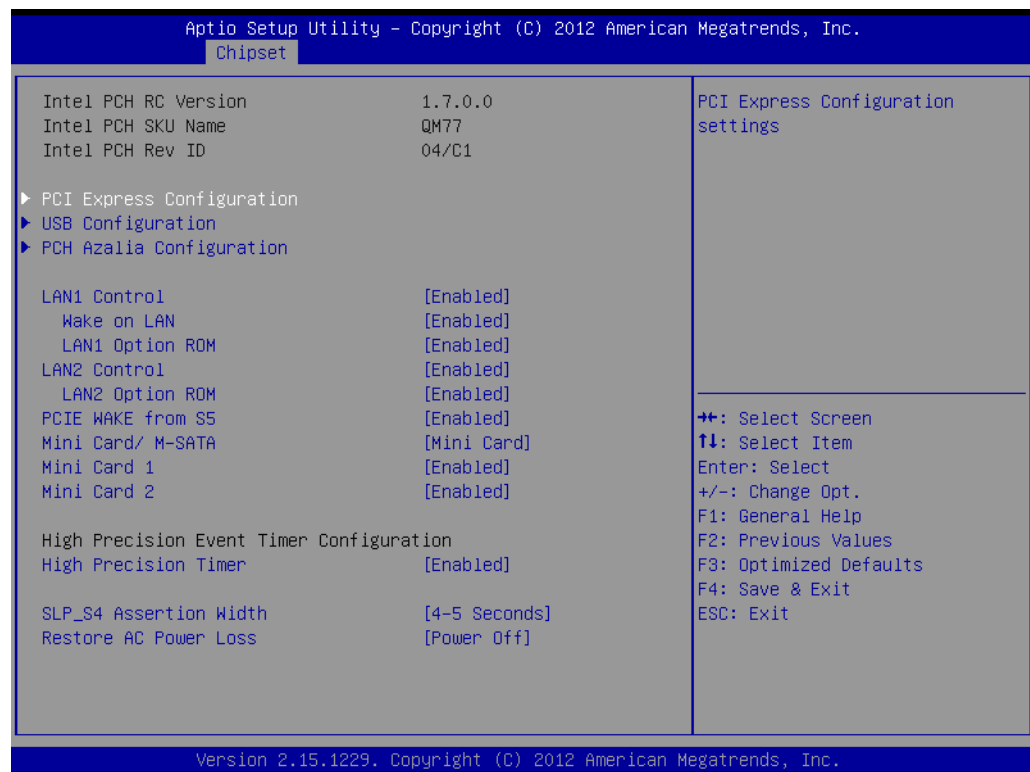

Figure 3.18 PCH-IO Configuration

PCI Express Configuration

This item allows users to configuration PCIE1~PCIE8 root port detail settings.

USB Configuration

This item allows users to configuration detail of USB functions.

PCH Azalia Configuration

This item allows users to configuration detail of azalia functions.

PCH LAN controller

Enables or disables the PCH LAN controller.

PCIE Wake from S5

PCIE wake Enables or disables from S5 state.

MINI Card/M-SATA

This item allows users to select MINI card or M-SATA function.

WiFi Card1/WiFi Card 2

This item allows users to enables or disables the WiFi Card1/WiFi Card 2 if device exist.

High Precision Timer

Enables or disables the high precision timer.

SLP_S4 Assertion Width

This item allows users to set a delay of sorts.

Restore AC Power Loss

This item allows users to select off, on and last state.

3.4.2 System Agent (SA) Configuration

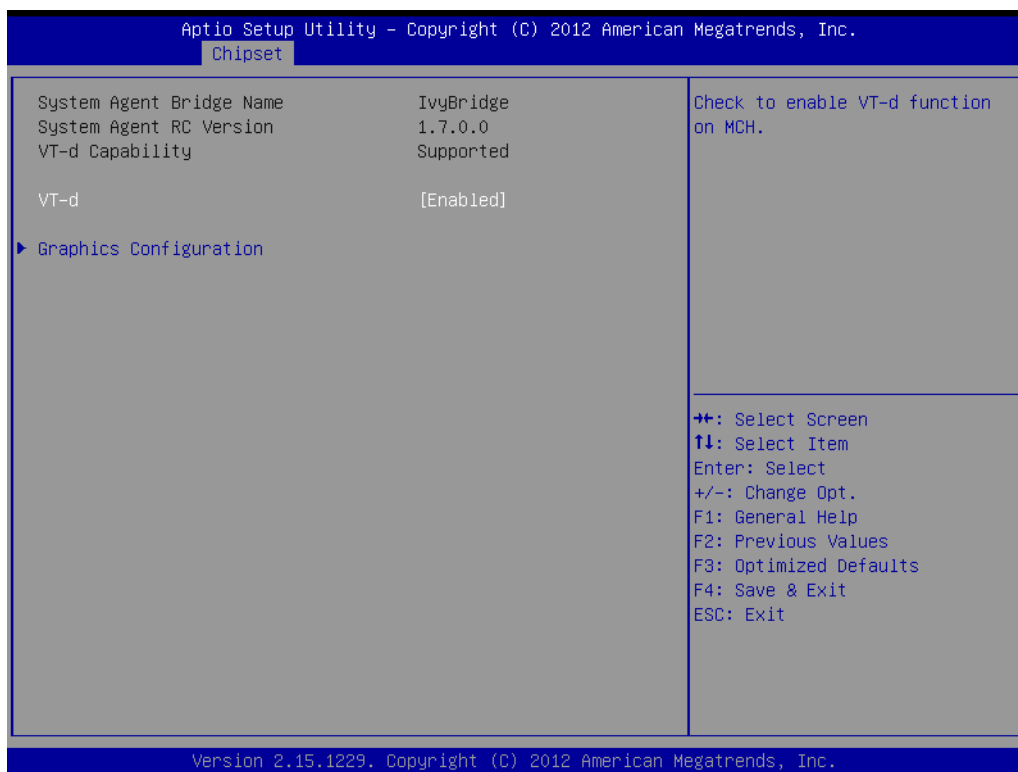

Figure 3.19 System Agent (SA) Configuration

3.4.2.1 Intel IGFX Configuration

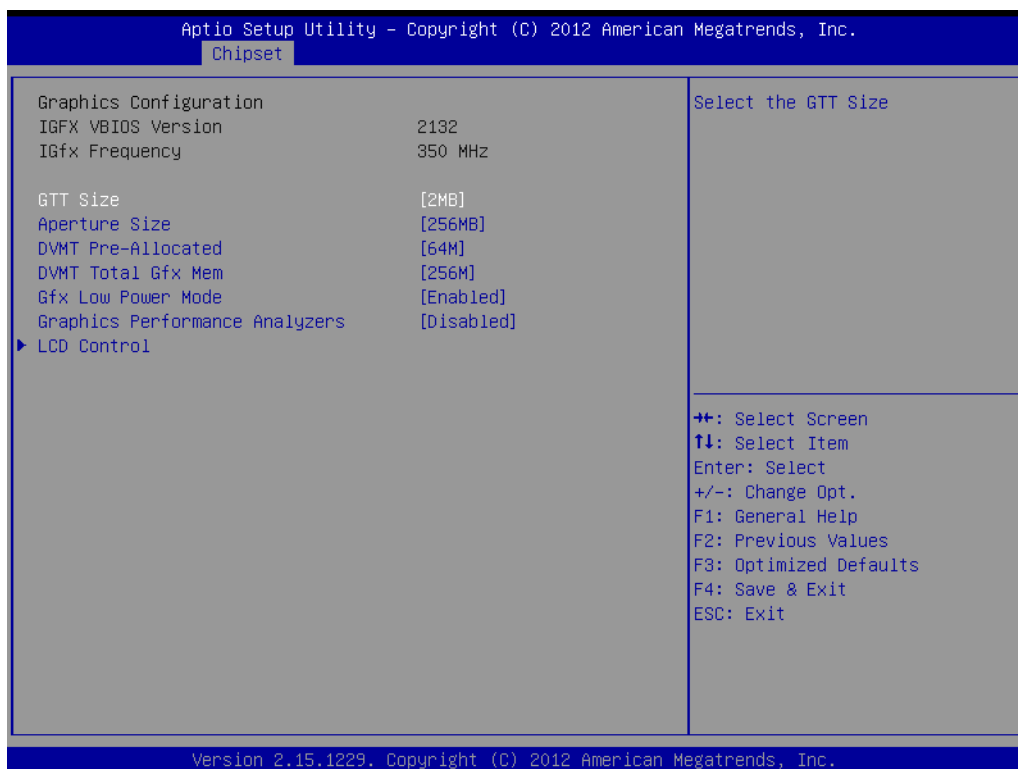

Figure 3.20 Intel IGFX Configuration

GTT Size

This item allows users to select GTT size.

Aperture Size

This item allows users to select aperture size.

DVMT Pre-Allocated

This item allows users to select DVMT pre-allocated memory size.

DVMT Total Gfx Mem

This item allows users to select DVMT total memory size.

Gfx Low Power Mode

This item allows users to enable or disable IGD low power mode.

Graphics Performance Analyzers

This item allows users to enable or disable Graphics Performance Analyzers

LCD Control

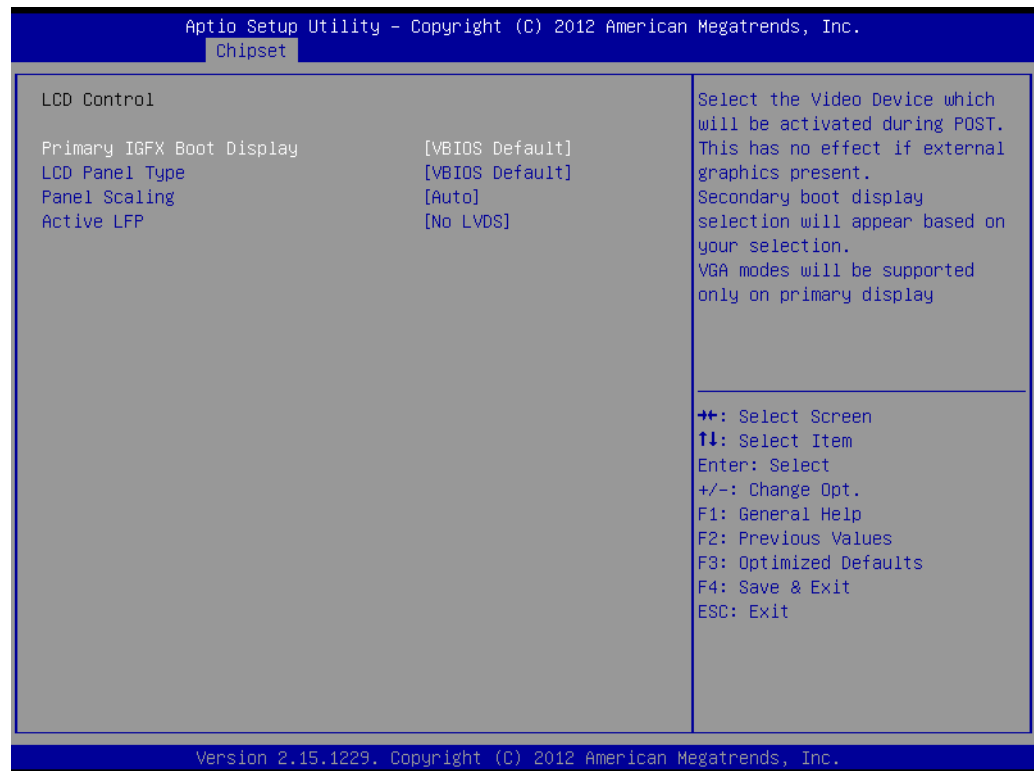

Figure 3.21 LCD Control

Primary IGFX Boot Display

Select boot display device at post stage.

LCD Panel Type

This item allows users to select panel resolution.

Panel Scaling

This item allows users to enable or disable panel scaling.

Active LFP

This item allows users to select LFP configuration.

3.5 Boot Settings

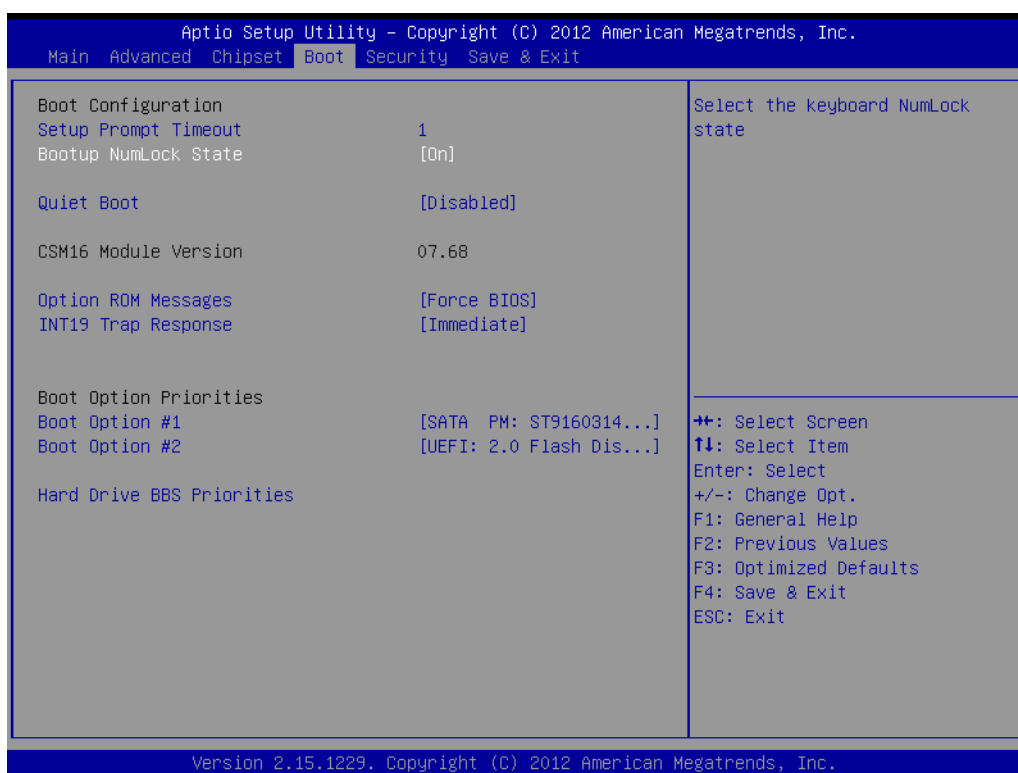

Figure 3.22 Boot Setup Utility

Setup Prompt Timeout

This item allows users to select the number of seconds to wait for setup activation key.

Bootup NumLock State

Select the Power-on state for Numlock.

Quiet Boot

If this option is set to Disabled, the BIOS displays normal POST messages. If Enabled, an OEM Logo is shown instead of POST messages.

Option ROM Message

Set display mode for option ROM.

INT19 Trap Response

This item allows option ROMs to trap interrupt 19.

3.6 Security Setup

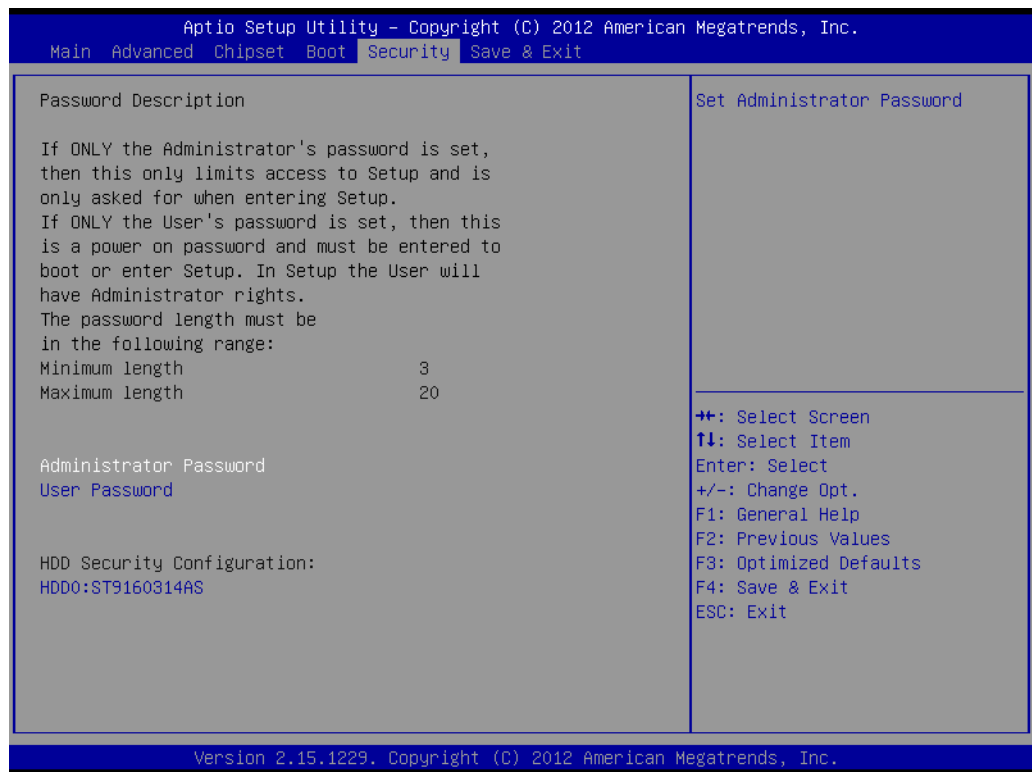

Figure 3.23 Password Configuration

Select Security Setup from the ARK-2150 Setup main BIOS setup menu. All Security Setup options, such as password protection is described in this section. To access the sub menu for the following items, select the item and press <Enter>:

Change Administrator / User Password: Select this option and press <ENTER> to access the sub menu, and then type in the password.

3.7 Save & Exit

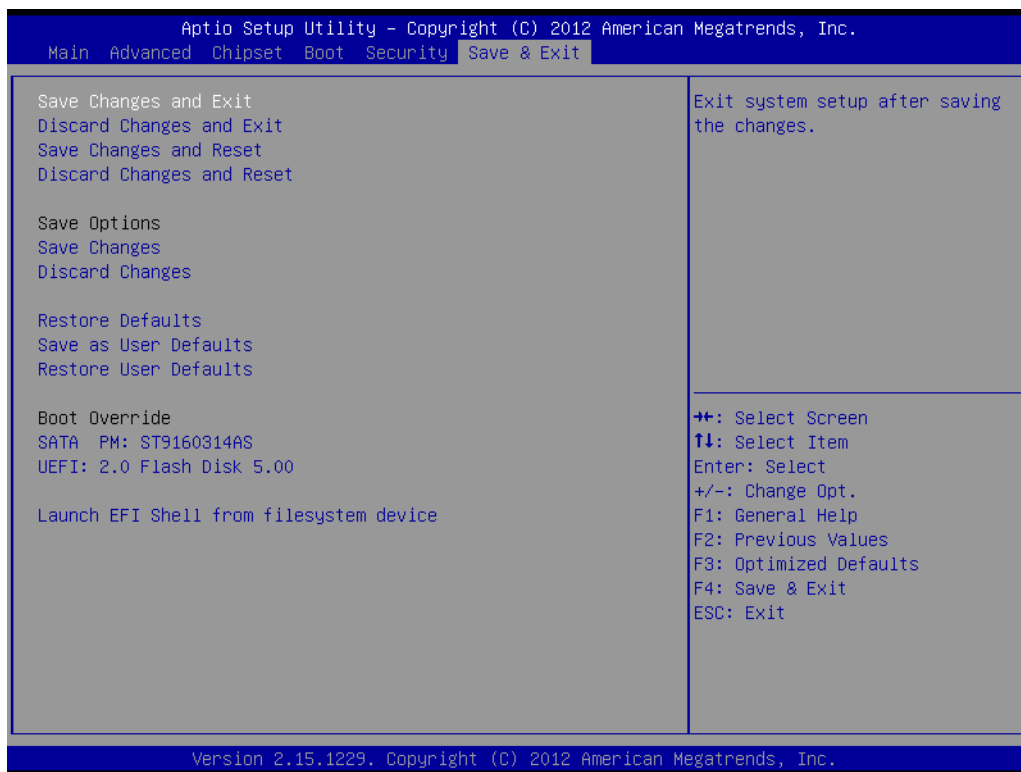

Figure 3.24 Save & Exit

Save Changes and Exit

When users have completed system configuration, select this option to save changes, exit BIOS setup menu and reboot the computer if necessary to take effect all system configuration parameters.

Discard Changes and Exit

Select this option to quit Setup without making any permanent changes to the system configuration.

Save Changes and Reset

When users have completed system configuration, select this option to save changes, exit BIOS setup menu and reboot the computer to take effect all system configuration parameters.

Discard Changes and Reset

Select this option to quit Setup without making any permanent changes to the system configuration and reboot the computer.

Save Changes

When users have completed system configuration, select this option to save changes without exit BIOS setup menu.

Discard Changes

Select this option to discard any current changes and load previous system configuration.

Restore Defaults

The ARK-2150 automatically configures all setup items to optimal settings when users select this option. Optimal Defaults are designed for maximum system performance, but may not work best for all computer applications. In particular, do not use

the Optimal Defaults if the user's computer is experiencing system configuration problems.

Save User Defaults

When users have completed system configuration, select this option to save changes as user defaults without exit BIOS setup menu.

Restore User Defaults

The users can select this option to restore user defaults.

Appendix **A**

Watchdog Timer
Sample Code

A.1 EC Watchdog Timer sample code

```
EC_Command_Port = 0x29Ah
EC_Data_Port = 0x299h
Write EC HW ram = 0x89
Watch dog event flag = 0x57
Watchdog reset delay time = 0x5E
Reset event = 0x04
Start WDT function = 0x28
=====
.model small
.486p
.stack 256
.data
.code
org 100h
.STARTup

mov dx, EC_Command_Port
mov al,89h      ; Write EC HW ram.
out dx,al

mov dx, EC_Command_Port
mov al, 5Fh     ; Watchdog reset delay time low byte (5Eh is high byte) index.
out dx,al

mov dx, EC_Data_Port
mov al, 30h     ;Set 3 seconds delay time.
out dx,al

mov dx, EC_Command_Port
mov al,89h     ; Write EC HW ram.
out dx,al

mov dx, EC_Command_Port
mov al, 57h    ; Watch dog event flag.
out dx,al

mov dx, EC_Data_Port
mov al, 04h    ; Reset event.
out dx,al

mov dx, EC_Command_Port
mov al,28h    ; start WDT function.
out dx,al

.exit
END
```

ADVANTECH

Enabling an Intelligent Planet

www.advantech.com

Please verify specifications before quoting. This guide is intended for reference purposes only.

All product specifications are subject to change without notice.

No part of this publication may be reproduced in any form or by any means, electronic, photocopying, recording or otherwise, without prior written permission of the publisher.

All brand and product names are trademarks or registered trademarks of their respective companies.

© Advantech Co., Ltd. 2013