

AR24208CHSSL



Sample image

Order symbol: AR24208CHSSL

Product nbr: 8561379

Description: PC Enclosure

Remarks: Hinged opaque cover w/S.S. Lockable latch

Including: Hinged cover. Base with 10-32 brass inserts, latched cover with formed in place PUR gasket, stainless hinge pin. Quick release latches. Enclosure mounting foot kit. Accessory 10-32 screws for panel mounting.

EAN: 6418074089953

El. number:

- Finland:
- Denmark:
- Sweden:

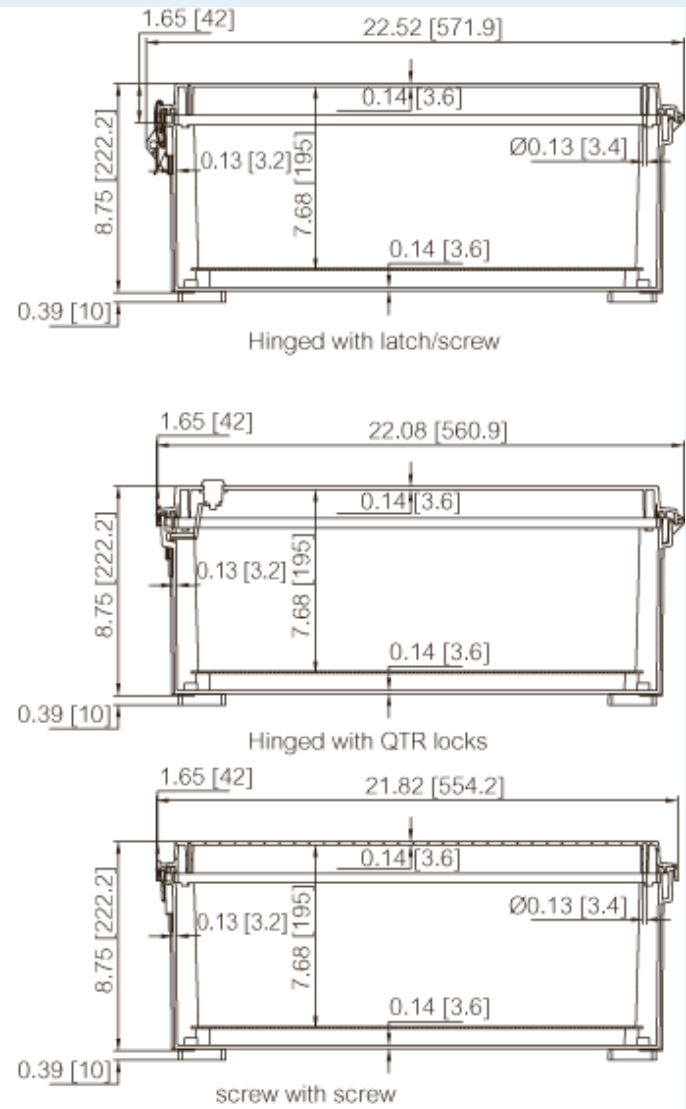
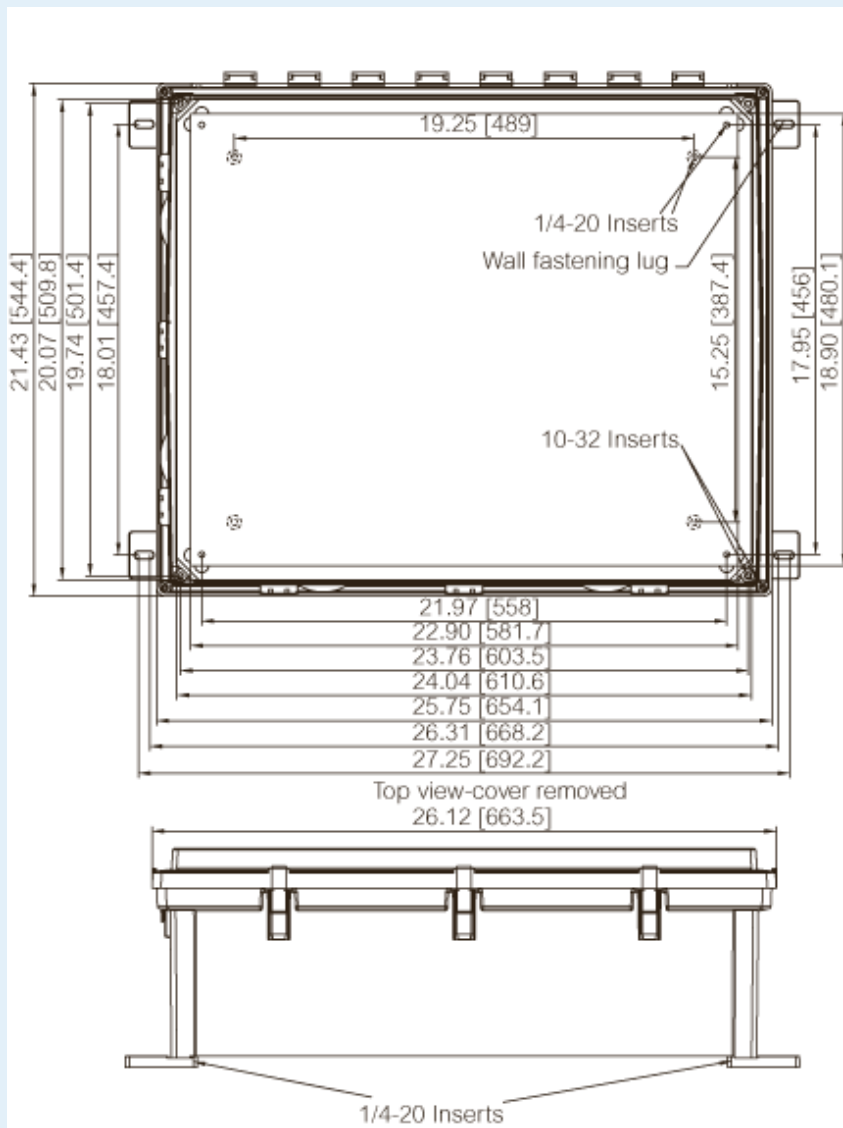

Dimensions:	Height	Width	Depth
mm:	611	510	205
inch:	24	20	8

Materials:

Material:	Polycarbonate
Base colour:	RAL 7035 -light grey
Cover colour:	RAL 7035 -light grey
Gasket material:	Polyurethane

Temperatures:

Temperature °C (short term):	-40 ... 140
Temperature °C (continuous):	-40 ... 80
Temperature °F (short term):	-40 ... 250
Temperature °F (continuous):	-40 ... 175

Rating:

Ingress protection (EN 60529):	IP66; IP67;
Impact Resistance (EN 62262):	IK09;
Electrical insulation:	Not insulated
Halogen free (DIN/VDE 0472, Part 815):	1
UV resistance:	UL 508
Flammability Rating:	UL 508
Glow Wire Test (IEC 695-2-1) °C:	960 °C
NEMA Class	NEMA 4, 4X, 12 and 13

Certificates:

ARCA_CertificateofCompliance