

Power Inductor APSA Series

**Automotive
AEC-Q200**

RoHS Compliant
Halogen Free
REACH Compliant



Power
Circuit

Shield

Wire
Wound

Ferrite

Part Numbering

A	PSA	00	131358	100	M	00
Grade	Series Name	Control Code	Dimensions Code (mm)	Inductance (uH)	Tolerance	Internal Code
			060630 6.3x6.3x3.0	6R0 6.0	M ±20%	
			070748 7.3x7.3x4.8	100 10	T ±30%	
			070758 7.3x7.3x5.8	101 100		
			131358 12.5x12.5x5.8			

Please be sure to request approval specifications that provide further details of the products. Kindly note that the content of these specifications are subject to change or may be discontinued without prior notice. This product may not be designed/used in medical or high risk applications without Chilisin approval. Please contact our sales department before ordering.

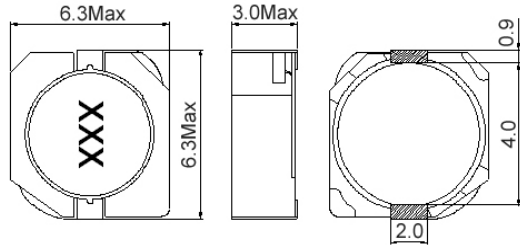
APSA00060630 Type
■ Dimensions

unit:mm

■ Recommended Land Pattern

unit:mm

■ Electrical Characteristics

Part No.	Inductance (uH)	Test Freq.	SRF (MHz)Min	RDC (mΩ)Max.	Isat (A)	Irms (A)	Tolerance (±%)	Marking
APSA000606306R8□00	6.8	100 kHz, 1 V	35	42	1.50	2.20	20	6R8
APSA00060630100□00	10	100 kHz, 1 V	20	63.8	1.30	1.80	20	100
APSA00060630150□00	15	100 kHz, 1 V	15	89.4	1.00	1.40	20	150
APSA00060630220□00	22	100 kHz, 1 V	10	124	0.77	1.30	20	220
APSA00060630330□00	33	100 kHz, 1 V	7	177	0.69	1.10	20	330
APSA00060630470□00	47	100 kHz, 1 V	5	252	0.59	0.92	20	470
APSA00060630680□00	68	100 kHz, 1 V	4	348	0.50	0.78	20	680
APSA00060630101□00	100	100 kHz, 1 V	4	516	0.42	0.64	20	101
APSA00060630151□00	150	100 kHz, 1 V	4	780	0.34	0.50	20	151
APSA00060630221□00	220	100 kHz, 1 V	3.2	1170	0.26	0.38	20	221

Note: When ordering, please specify tolerance code. Tolerance: M=±20% / T=±30%

- Operating temperature range - 40°C ~ 125°C(Including self - temperature rise)
- Isat for Inductance drop 30% from its value without current.
- Irms for a 25°C temprature rise from 25°C ambient.
- Measure Equipment:
 L: WK6500B+WK6565
 RDC: Chroma 16502
 Isat: WK3260B+WK3265B

APSA00060630 Type

Characteristics Graph

Inductance vs. Frequency Characteristics

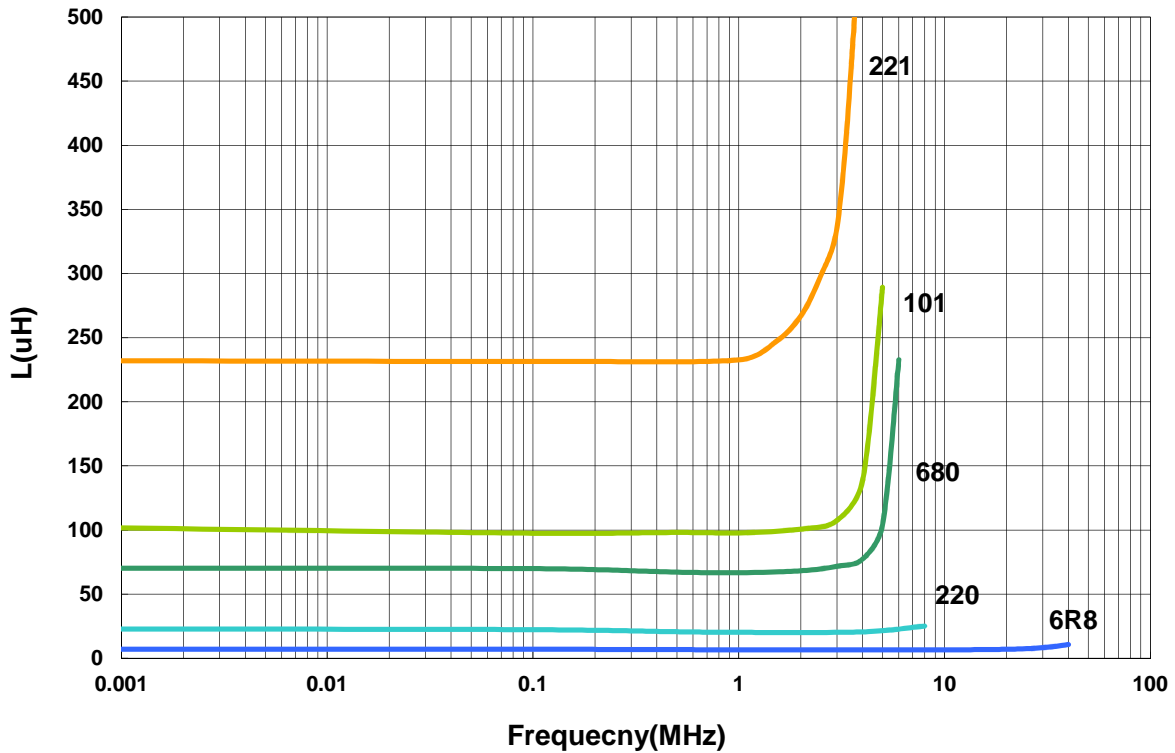

Inductance vs. DC Current

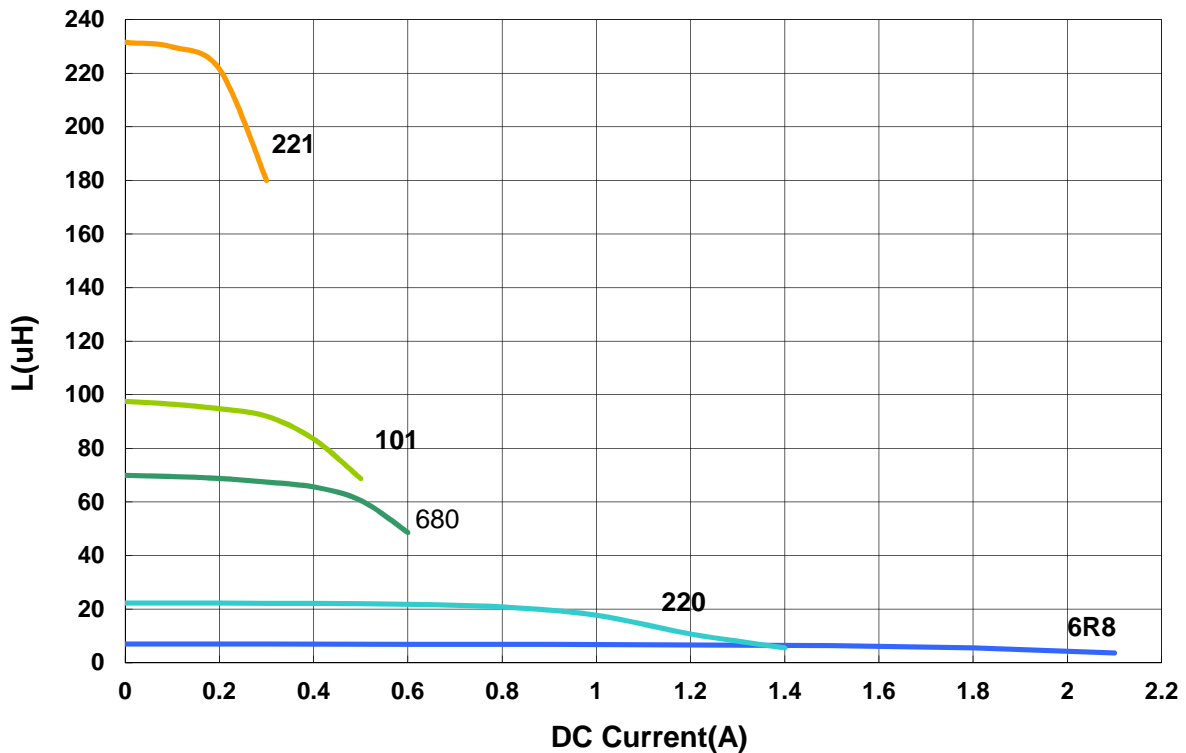

Please be sure to request approval specifications that provide further details of the products. Kindly note that the content of these specifications are subject to change or may be discontinued without prior notice. This product may not be designed/used in medical or high risk applications without Chilisin approval. Please contact our sales department before ordering.

APSA00070748 Type

■ Dimensions

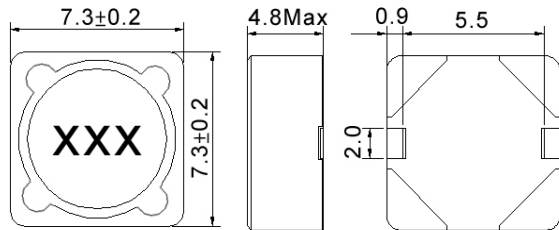

unit:mm

■ Recommended Land Pattern

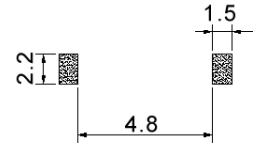

unit:mm

■ Electrical Characteristics

Part No.	Inductance (uH)	Test Freq.	SRF (MHz)Min	RDC (mΩ)Max.	Isat (A)	Irms (A)	Tolerance (±%)	Marking
APSA000707483R3□00	3.3	100 kHz, 1 V	90	24	2.50	2.30	20	3R3
APSA000707484R7□00	4.7	100 kHz, 1 V	65	36	2.00	2.10	20	4R7
APSA000707486R8□00	6.8	100 kHz, 1 V	24	40	1.70	1.74	20	6R8
APSA00070748100□00	10	100 kHz, 1 V	17	43.2	1.30	1.78	20	100
APSA00070748150□00	15	100 kHz, 1 V	14	62.4	1.10	1.53	20	150
APSA00070748220□00	22	100 kHz, 1 V	11	73.2	0.90	1.34	20	220
APSA00070748330□00	33	100 kHz, 1 V	10	115	0.82	1.09	20	330
APSA00070748470□00	47	100 kHz, 1 V	8.0	150	0.75	0.92	20	470
APSA00070748680□00	68	100 kHz, 1 V	7.0	210	0.60	0.77	20	680
APSA00070748101□00	100	100 kHz, 1 V	6.0	300	0.50	0.65	20	101
APSA00070748151□00	150	100 kHz, 1 V	4.0	408	0.40	0.55	20	151
APSA00070748221□00	220	100 kHz, 1 V	3.5	624	0.33	0.45	20	221
APSA00070748331□00	330	100 kHz, 1 V	3.0	880	0.25	0.37	20	331
APSA00070748471□00	470	100 kHz, 1 V	2.5	1260	0.22	0.31	20	471
APSA00070748681□00	680	100 kHz, 1 V	2.1	1770	0.20	0.27	20	681

Note: When ordering, please specify tolerance code. Tolerance: M=±20% / T=±30%

1. Operating temperature range - 40°C ~ 125°C(Including self - temperature rise)
2. Isat for Inductance drop 10% from its value without current.
3. I rms for a 20°C temprature rise from 25°C ambient.

4. Measure Equipment:

L: WK6500B+WK6565

RDC: Chroma 16502

Isat: WK3260B+WK3265B

APSA00070748 Type

Characteristics Graph

Inductance vs. Frequency Characteristics

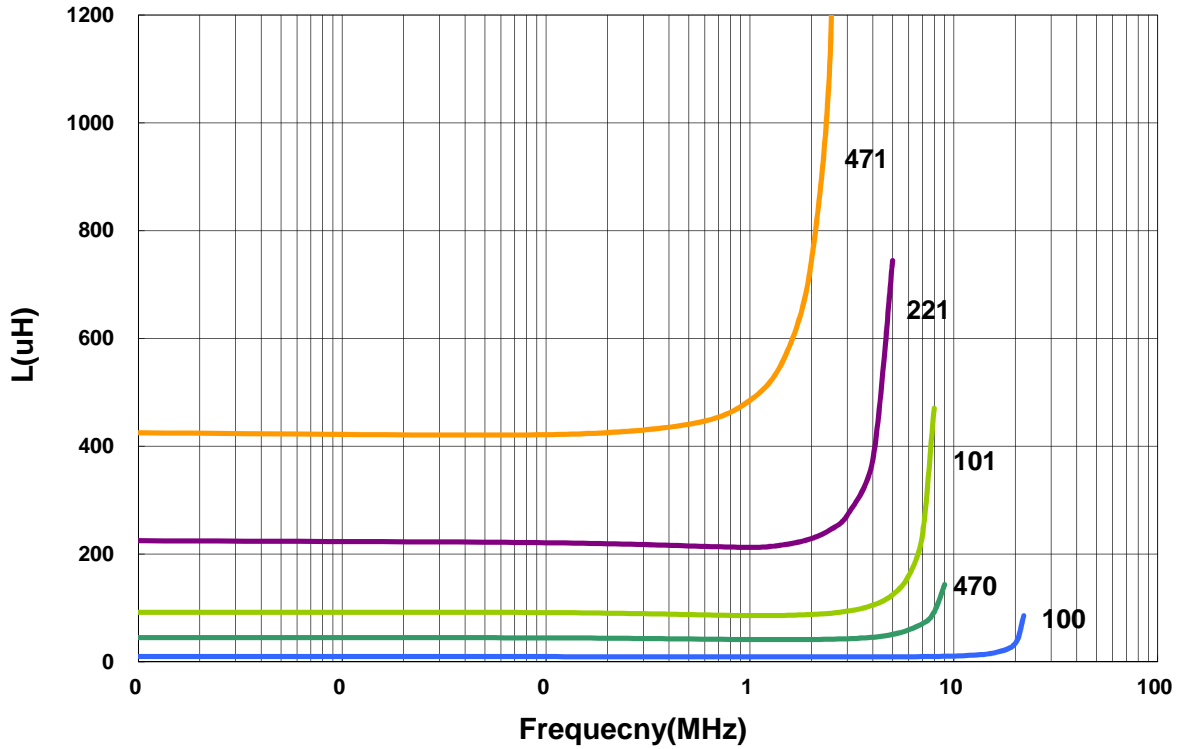

Inductance vs. DC Current

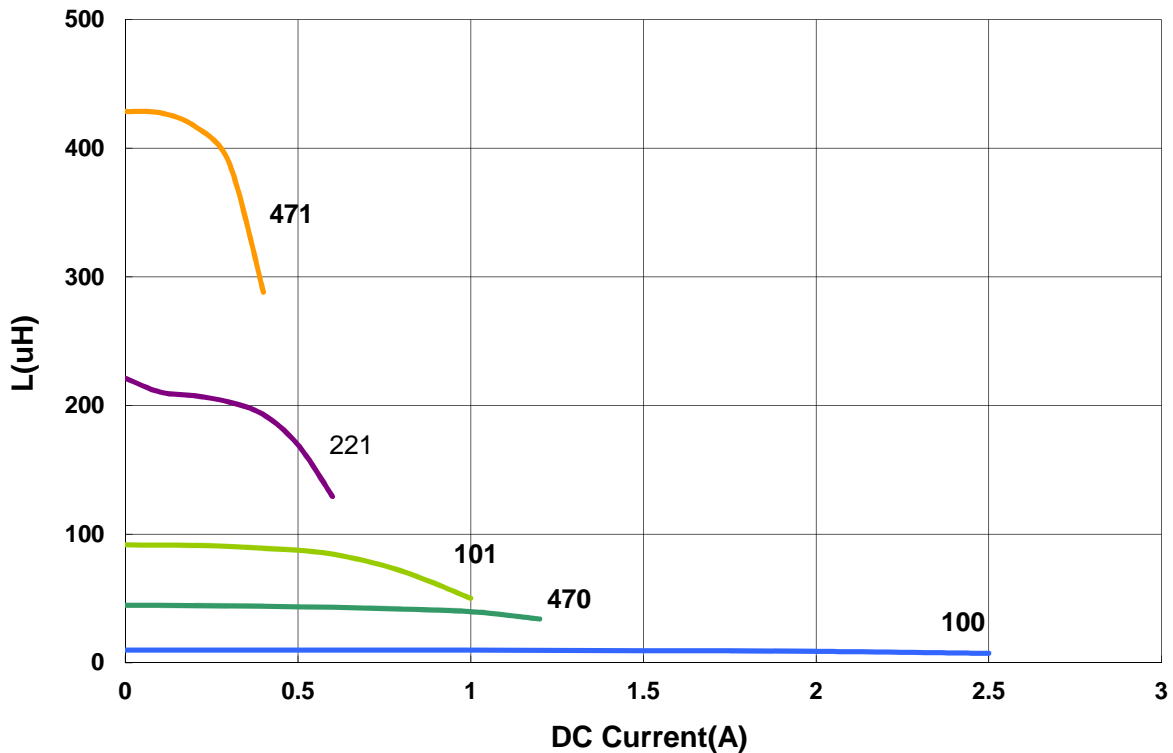

Please be sure to request approval specifications that provide further details of the products. Kindly note that the content of these specifications are subject to change or may be discontinued without prior notice. This product may not be designed/used in medical or high risk applications without Chilisin approval. Please contact our sales department before ordering.

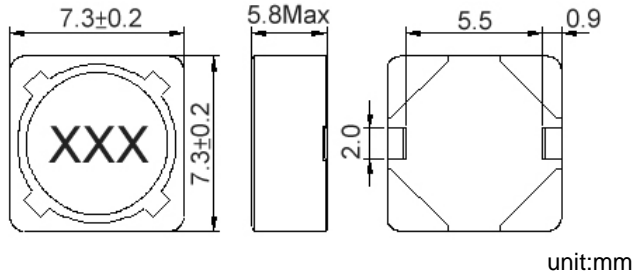
APSA00070758 Type
■ Dimensions

unit:mm

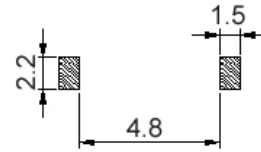
■ Recommended Land Pattern

unit:mm

■ Electrical Characteristics

Part No.	Inductance (uH)	Test Freq.	SRF (MHz)Min	RDC (mΩ)Max.	Isat (A)	Irms (A)	Tolerance (±%)	Marking
APSA000707581R5□00	1.5	100 kHz, 1 V	75	20	6.2	4.0	30	1R5
APSA000707582R2□00	2.2	100 kHz, 1 V	55	23	5.3	3.5	30	2R2
APSA000707583R3□00	3.3	100 kHz, 1 V	48	31	4.3	3.3	30	3R3
APSA000707584R7□00	4.7	100 kHz, 1 V	38	36	3.6	3.1	30	4R7
APSA000707586R8□00	6.8	100 kHz, 1 V	35	44	3.0	2.8	30	6R8
APSA00070758100□00	10	100 kHz, 1 V	22	46	2.6	2.5	20	100
APSA00070758150□00	15	100 kHz, 1 V	14	60.9	2.1	2.2	20	150
APSA00070758220□00	22	100 kHz, 1 V	8	77	1.7	2.0	20	220

Note: When ordering, please specify tolerance code. Tolerance: M=±20% / T=±30%

- Operating temperature range - 40°C ~ 125°C(Including self - temperature rise)
- Isat for Inductance drop 10% from its value without current.
- Irms for a 30°C temprature rise from 25°C ambient.
- Measure Equipment:
 L: WK6500B+WK6565
 RDC: Chroma 16502
 Isat: WK3260B+WK3265B

APSA00070758 Type

Characteristics Graph

Inductance vs. Frequency Characteristics

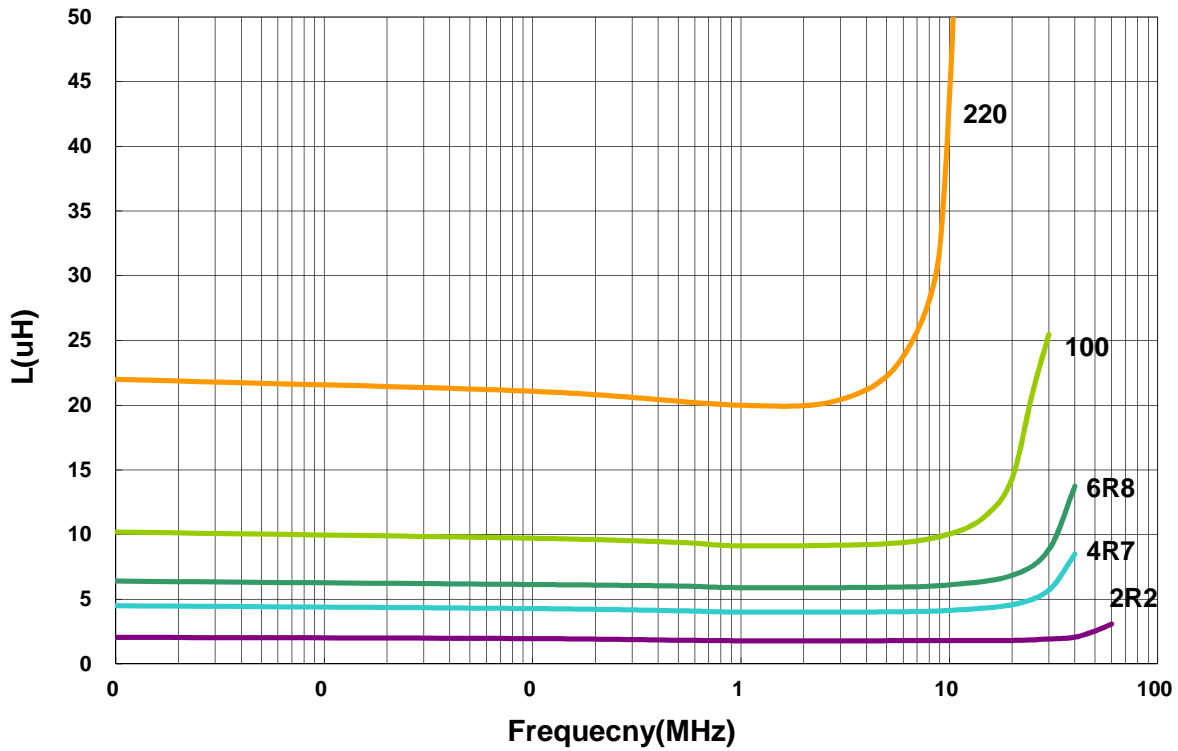

Inductance vs. DC Current

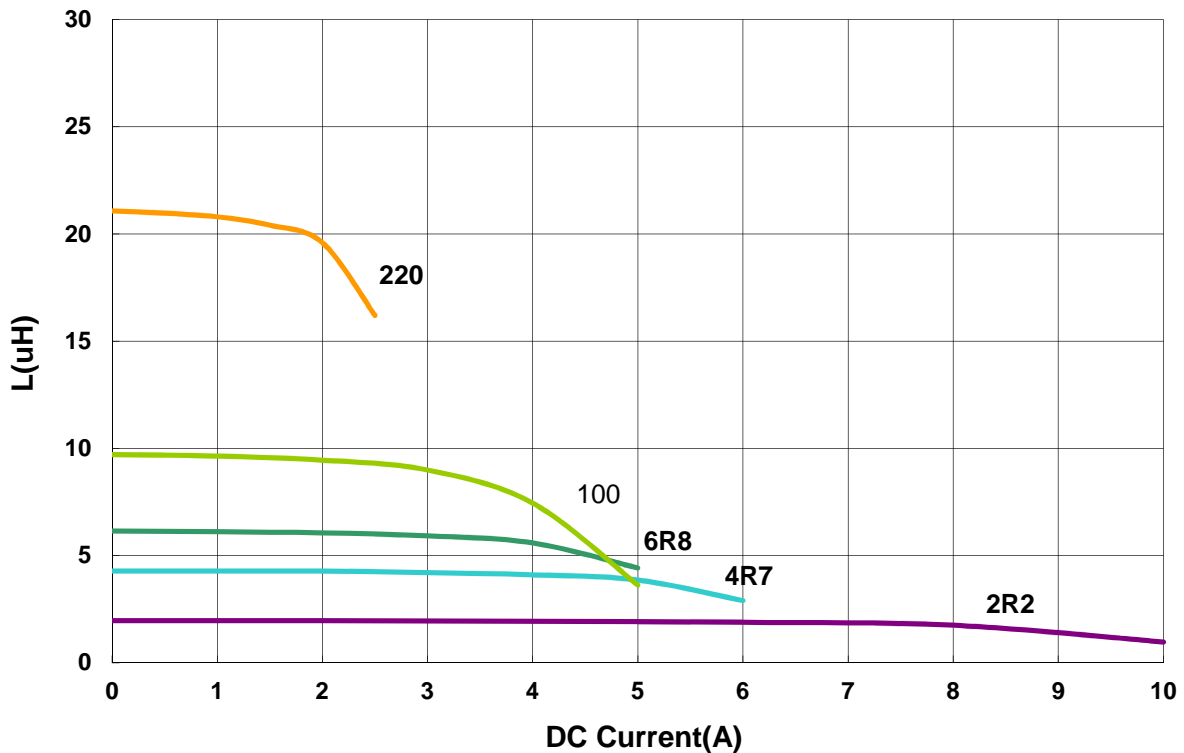

Please be sure to request approval specifications that provide further details of the products. Kindly note that the content of these specifications are subject to change or may be discontinued without prior notice. This product may not be designed/used in medical or high risk applications without Chilisin approval. Please contact our sales department before ordering.

APSA00131358 Type

■ Dimensions

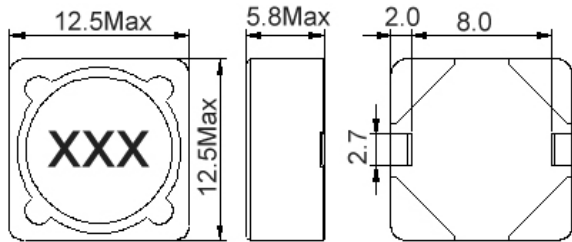

unit:mm

■ Recommended Land Pattern

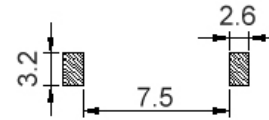

unit:mm

■ Electrical Characteristics

Part No.	Inductance (uH)	Test Freq.	SRF (MHz)Min	RDC (mΩ)Max.	Isat (A)	Irms (A)	Tolerance (±%)	Marking
APSA001313586R0□00	6.0	1 kHz,1 V	26	19.7	3.6	4.9	30	6R0
APSA00131358100□00	10	1 kHz,1 V	17	25.8	3.4	4.3	20	100
APSA00131358150□00	15	1 kHz,1 V	15	31.0	2.8	3.9	20	150
APSA00131358220□00	22	1 kHz,1 V	11	40.6	2.3	3.4	20	220
APSA00131358330□00	33	1 kHz,1 V	10	49.8	1.9	3.1	20	330
APSA00131358470□00	47	1 kHz,1 V	8	74.2	1.6	2.5	20	470
APSA00131358680□00	68	1 kHz,1 V	7	99.8	1.3	2.2	20	680
APSA00131358101□00	100	1 kHz,1 V	5.5	140	1.1	1.8	20	101
APSA00131358151□00	150	1 kHz,1 V	4.5	228	0.88	1.4	20	151
APSA00131358221□00	220	1 kHz,1 V	3.0	324	0.72	1.2	20	221
APSA00131358331□00	330	1 kHz,1 V	3.0	492	0.59	1.0	20	331
APSA00131358471□00	470	1 kHz,1 V	2.5	624	0.49	0.88	20	471
APSA00131358681□00	680	1 kHz,1 V	2.0	912	0.43	0.73	20	681
APSA00131358102□00	1000	1 kHz,1 V	1.7	1344	0.34	0.60	20	102
APSA00131358152□00	1500	1 kHz,1 V	1.4	2076	0.29	0.48	20	152

Note: When ordering, please specify tolerance code. Tolerance: M=±20% / T=±30%

1. Operating temperature range - 40°C ~ 125°C(Including self - temperature rise)
2. Isat for Inductance drop 10% from its value without current.
3. I rms for a 30°C temprature rise from 25°C ambient.

4. Measure Equipment:

L: WK6500B+WK6565

RDC: Chroma 16502

Isat: WK3260B+WK3265B

APSA00131358 Type

Characteristics Graph

Inductance vs. Frequency Characteristics

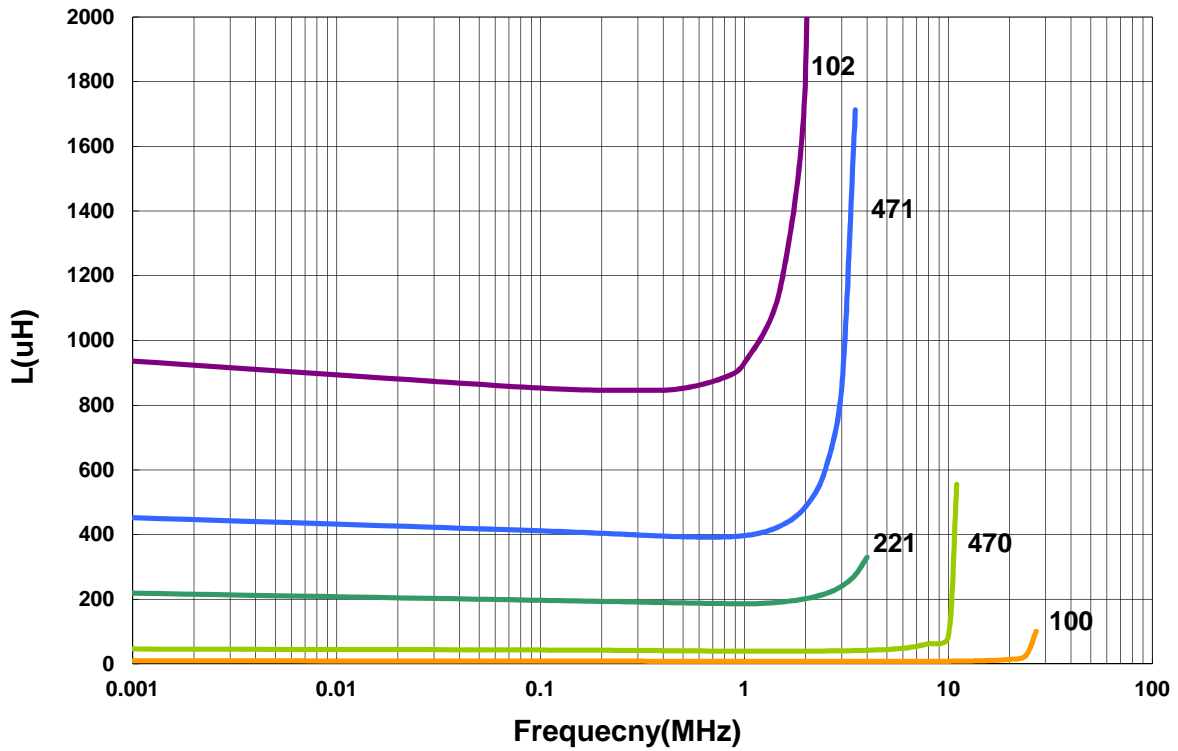

Inductance vs. DC Current

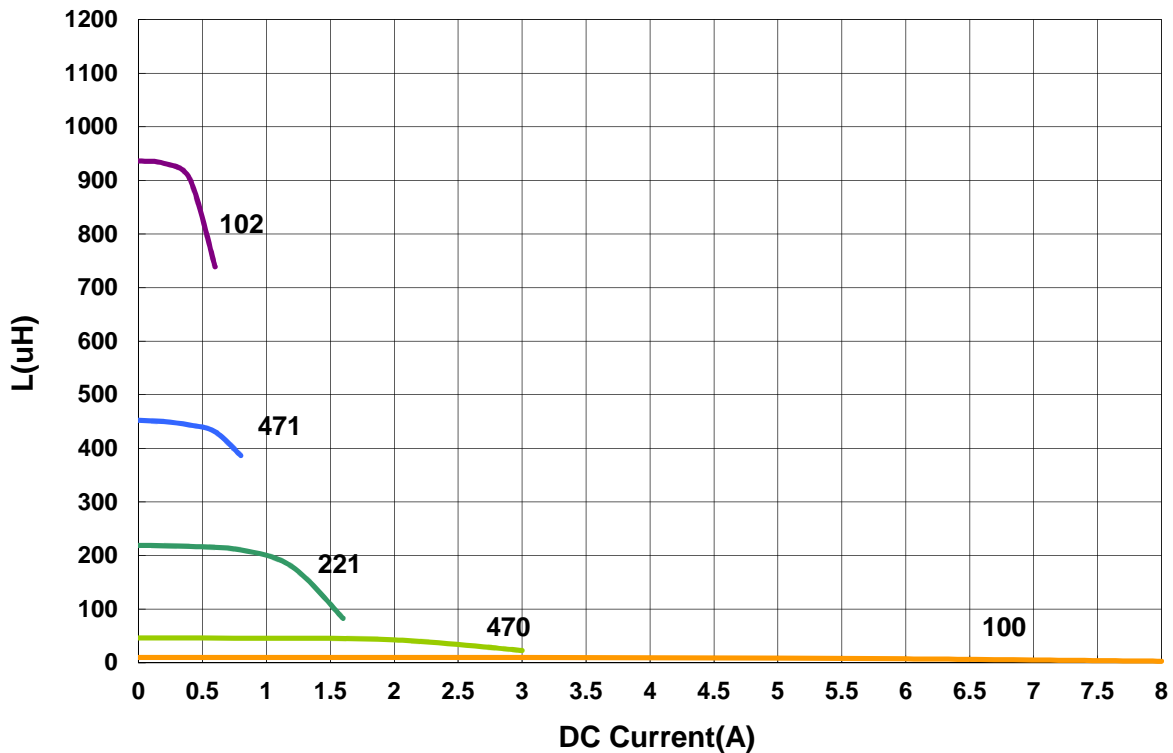

Please be sure to request approval specifications that provide further details of the products. Kindly note that the content of these specifications are subject to change or may be discontinued without prior notice. This product may not be designed/used in medical or high risk applications without Chilisin approval. Please contact our sales department before ordering.

■ Packaging

Tape Dimensions

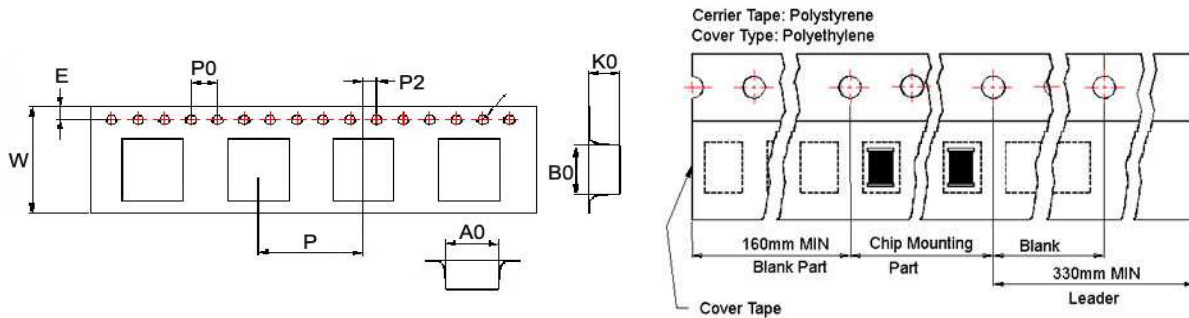

Reel Dimensions

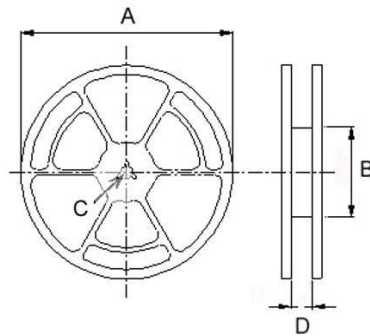

Dimensions in mm

TYPE	Tape Dimensions									Reel Dimensions				Quantity PCS / REEL
	A0	B0	K0	D	E	W	P	P0	P2	A	B	C	D	
APSA00060630	6.3	6.55	3.3	1.55	1.75	16	12	4	2	330	100	13	16.0	1000
APSA00070748	7.6	7.6	5.2	1.55	1.75	16	12	4	2	330	100	13	16.0	1000
APSA00070758	7.8	7.8	6.0	1.55	1.75	16	12	4	2	330	100	13	16.0	900
APSA00131358	12.6	12.6	6.7	1.55	1.75	24	16	4	2	330	100	13	24.2	600