

2.4GHz Patch Antenna with PCB and Cable Connector

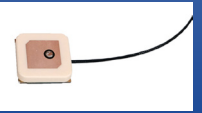

APARC2505-S2450



25.1 x 25.1 x 5.5 mm
RoHS/RoHS II Compliant
MSL = Not Applicable

Features

- 2.4 GHz Bluetooth/WiFi patch antenna
- RHCP polarization
- Low VSWR
- Integrated GND plane with cable
- Termination using IPEX connector

Applications

- WiFi/Bluetooth/BLE/Zigbee/ISM
- Mobile applications
- Drones, robotics
- IoT applications
- VR/AR applications
- Industrial controls

Electrical Specifications

Parameters	Min.	Typ.	Max.	Units	Notes
Operating Frequency	2450 ± 50			MHz	
Center Frequency	2451 ± 5			MHz	on PCB
VSWR			2.5		@2450 MHz
Peak Gain	0.5			dBi	
Polarization	RHCP				
Impedance	50			Ω	

Environmental Specifications

Parameters	Specification
Operating Temperature	-40°C to +105°C
Storage Temperature	-40°C to +105°C
Relative Humidity	0 ~ 95 %

Mechanical Specifications

Parameters	Specification	Notes
Cable Type	Ø1.37 mm	
Cable Length	150 mm	
Connector	I-PEX (MHF)	
Termination	Ag	Pb free

2.4GHz Patch Antenna with PCB and Cable Connector

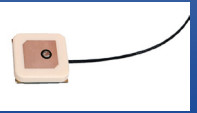

APARC2505-S2450



25.1 x 25.1 x 5.5 mm
RoHS/RoHS II Compliant
MSL = Not Applicable

Product Dimensions

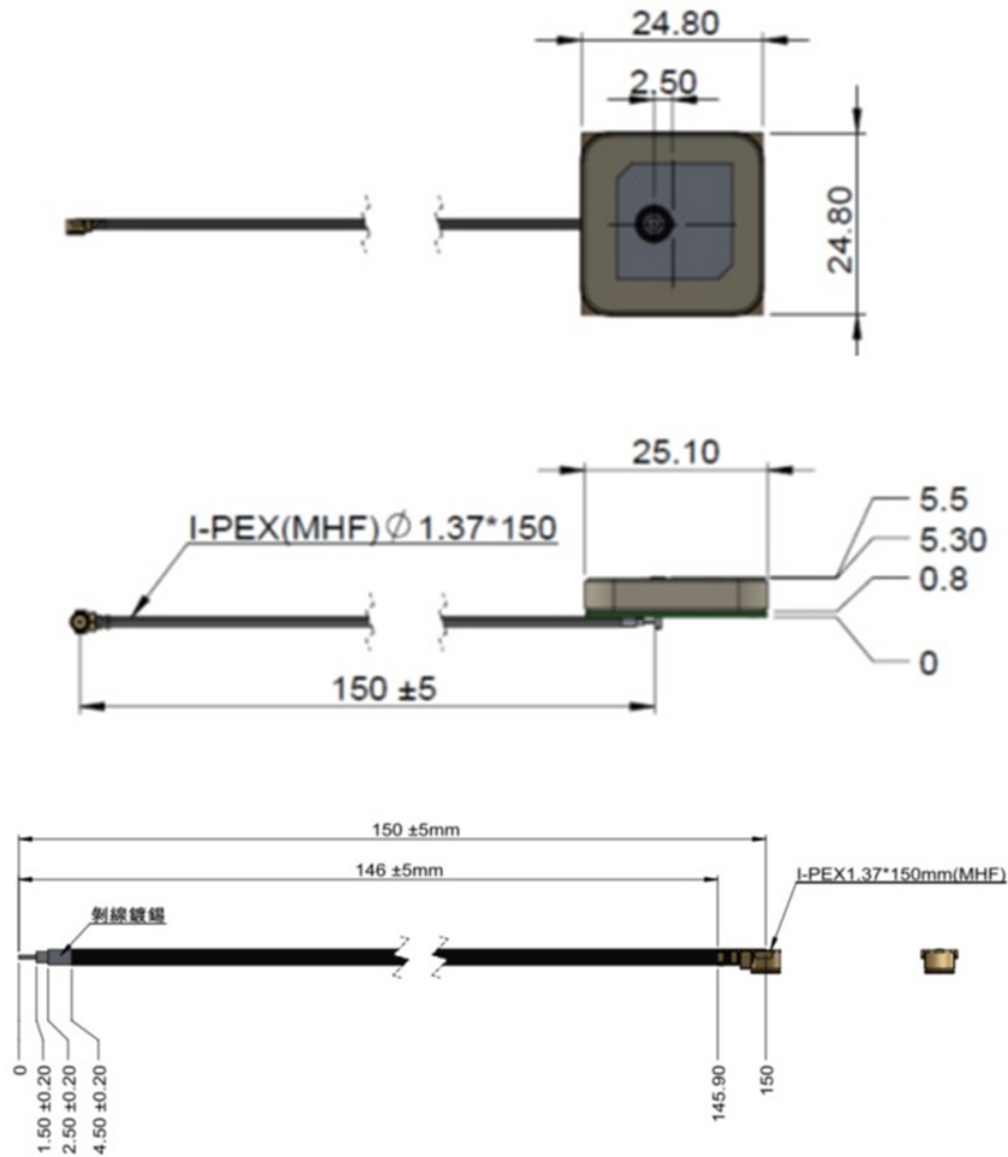

2.4GHz Patch Antenna with PCB and Cable Connector

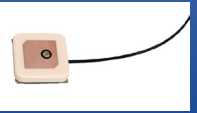

APARC2505-S2450



25.1 x 25.1 x 5.5 mm
RoHS/RoHS II Compliant
MSL = Not Applicable

PCB Dimensions

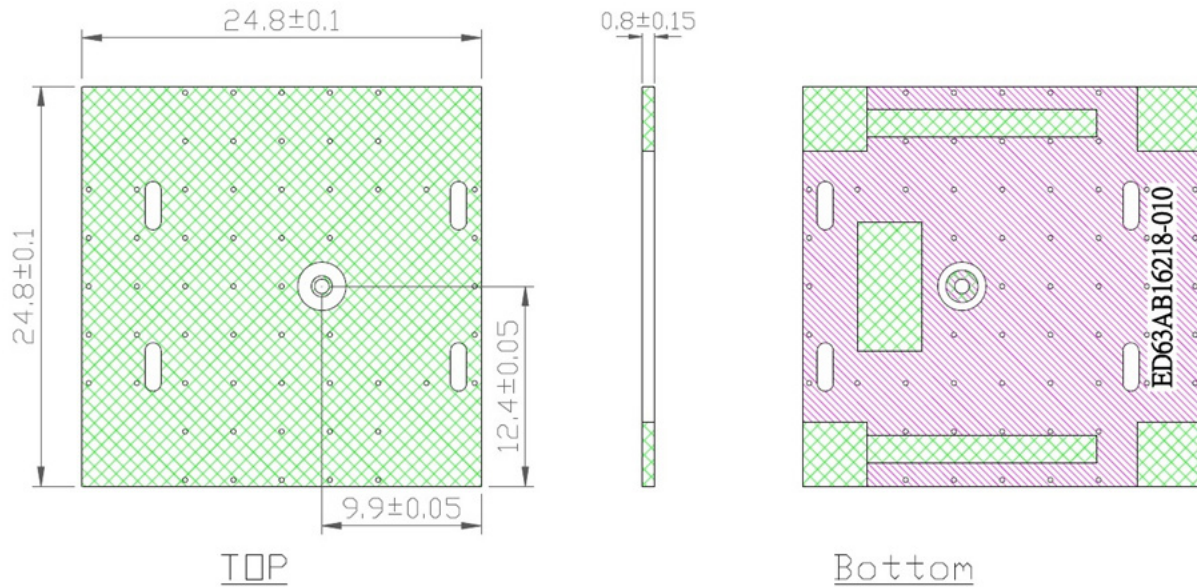

Tape Dimension

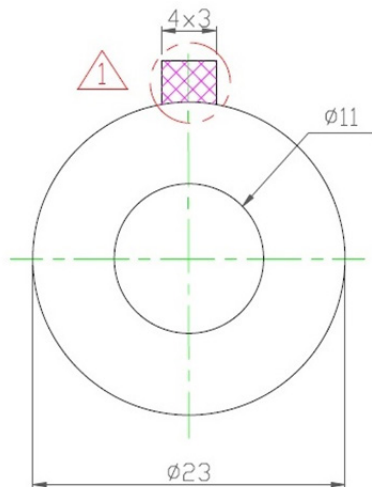

1. NITTO : NO.5015

2. Double-coated adhesive tape for industrial use

3. Thickness : 0.12mm

(Unit : mm)

2.4GHz Patch Antenna with PCB and Cable Connector

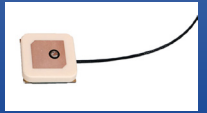

APARC2505-S2450



25.1 x 25.1 x 5.5 mm
RoHS/RoHS II Compliant
MSL = Not Applicable

Return Loss and Impedance Characteristics

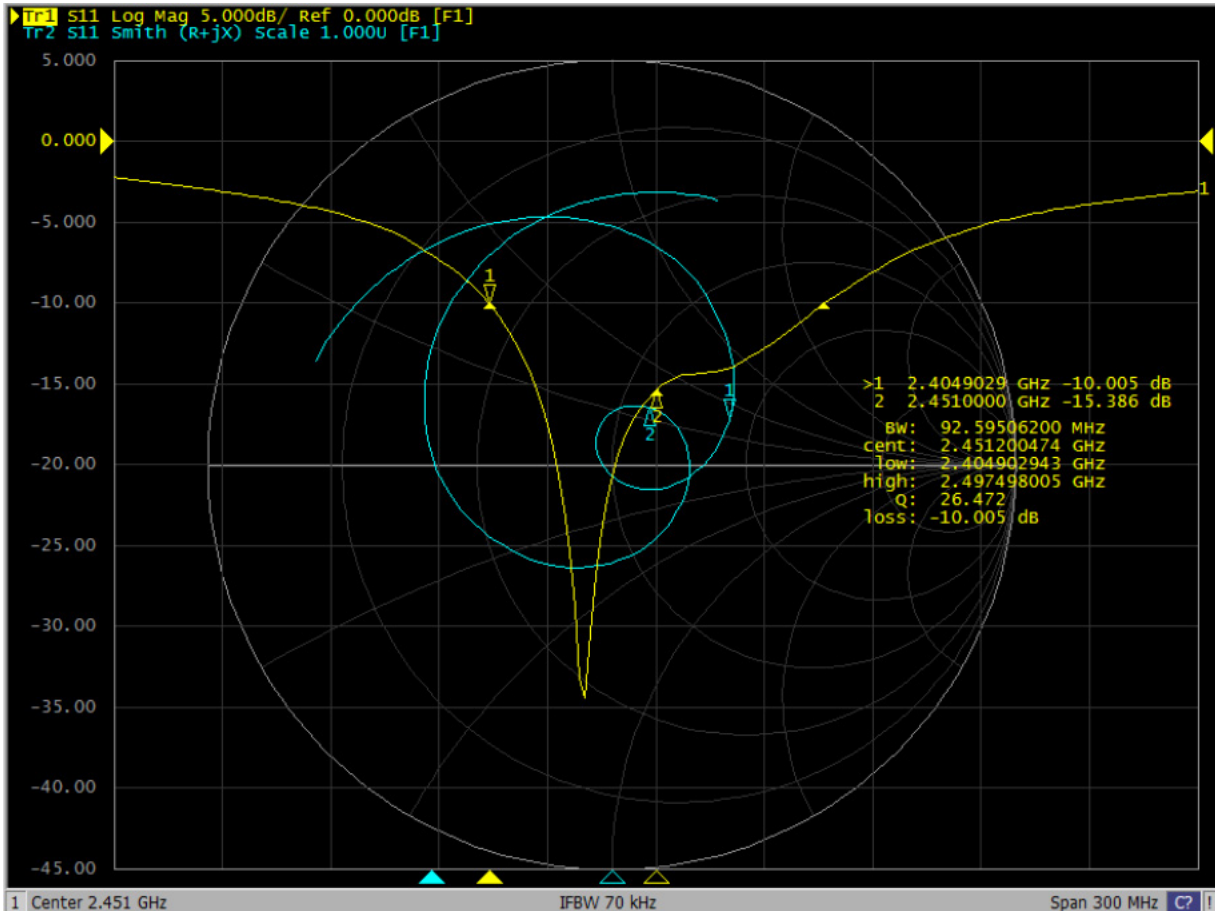

2.4GHz Patch Antenna with PCB and Cable Connector

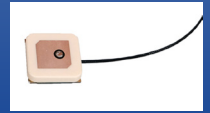

APARC2505-S2450



25.1 x 25.1 x 5.5 mm
RoHS/RoHS II Compliant
MSL = Not Applicable

Radiation Pattern

Measurement Plane

XZ-Plane

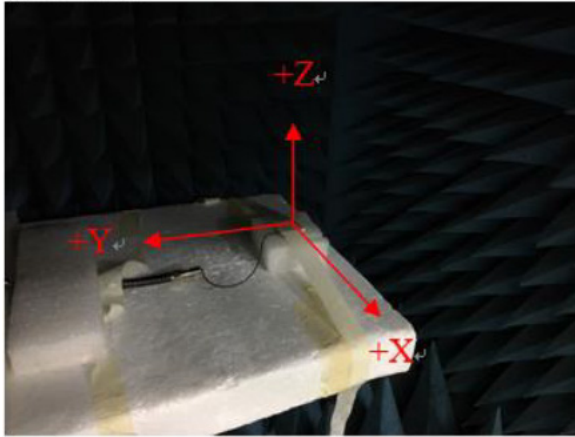

YZ-Plane

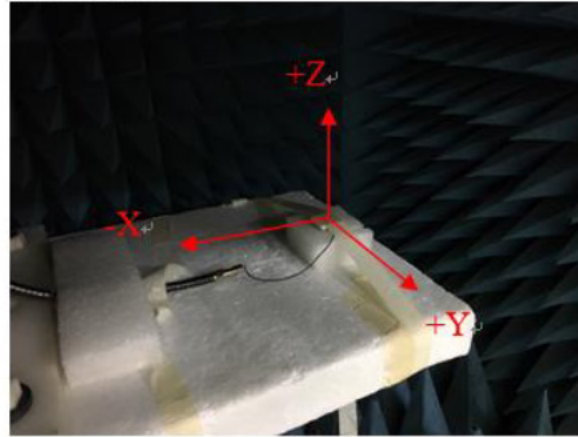

2.4GHz Patch Antenna with PCB and Cable Connector

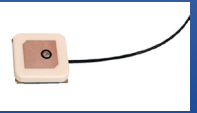

APARC2505-S2450



25.1 x 25.1 x 5.5 mm
RoHS/RoHS II Compliant
MSL = Not Applicable

Radiation Pattern

2D Pattern

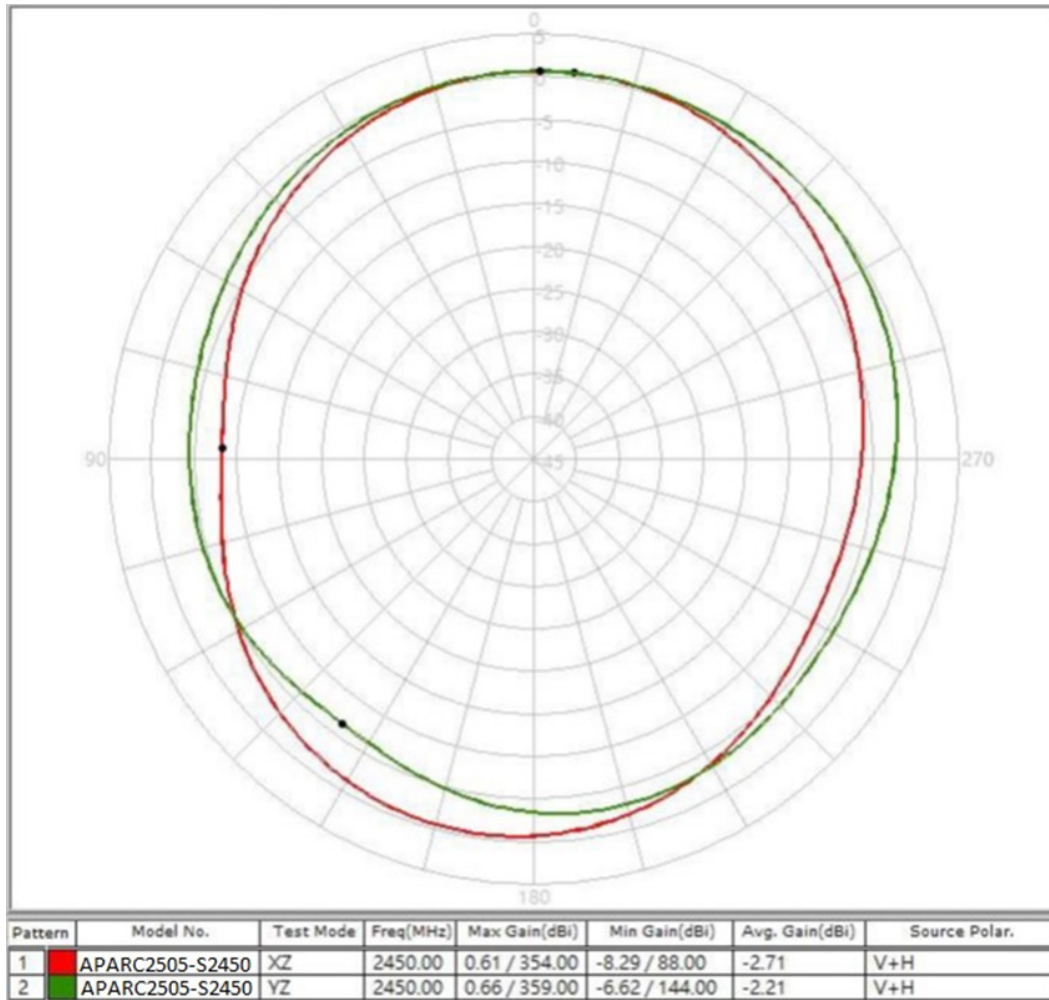

2.4GHz Patch Antenna with PCB and Cable Connector

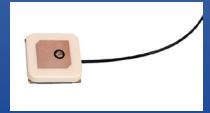

APARC2505-S2450



25.1 x 25.1 x 5.5 mm
RoHS/RoHS II Compliant
MSL = Not Applicable

Radiation Pattern

3D Pattern

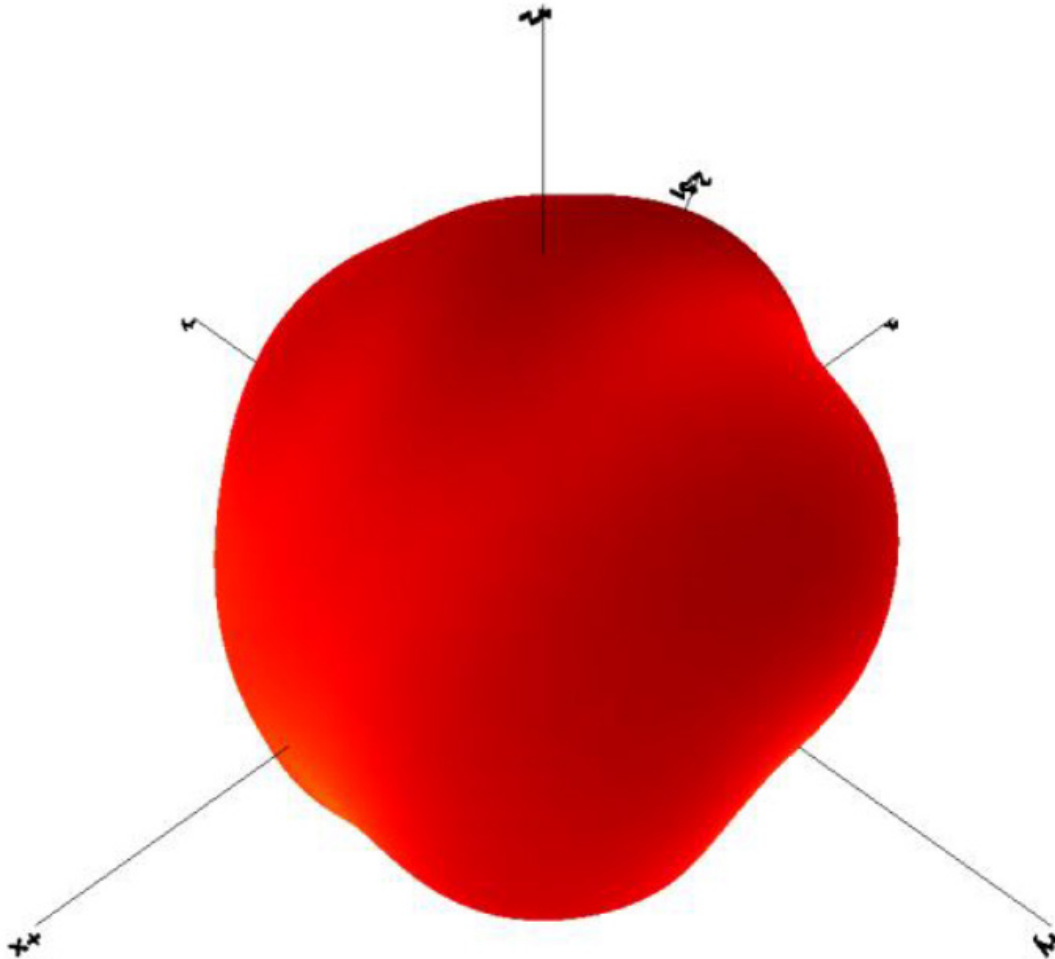

2.4GHz Patch Antenna with PCB and Cable Connector

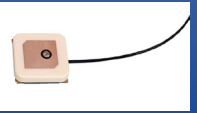

APARC2505-S2450



25.1 x 25.1 x 5.5 mm
RoHS/RoHS II Compliant
MSL = Not Applicable

Reliability Test

Test Condition	Test Exposure and Duration
Low Temperature test	Expose the specimen to -40°C for 400 hours and then to normal temperature/ humidity for 24 hours or more. After this test, examine its appearance and functions.
High-temperature test	Expose the specimen to +105°C for 400 hours and then to normal temperature / humidity for 24 hours or more. After this test, examine its appearance and functions.
High-temperature/ high-humidity test	Subject the object to the environmental conditions of +60°C and 90-95% relative humidity for 96 hours, then expose it to normal temperature/humidity for 24 hours or more. After this test, examine its appearance and functions.
Thermal shock test	Subject the object to cyclic temperature change (-40°C for 2 hours, then +85°C for 2 hours) for 100 cycles, then expose to normal temperature/ humidity for 24 hours or more.
Sinusoidal vibration test	Subject the object to vibrations of 5 to 200 to 5Hz swept in 10 minutes, 4.5G at maximum (2 mm amplitude), in X and Y directions for two hours each and in Z direction for four hours. After this test, examine its appearance functions.
Vibration test in packaged condition	Subject the object, which is packaged as illustrated, to vibrations of 15 to 60 to 15Hz swept in 6 minutes, 4G at maximum (2mm amplitude at maximum), applied in X, Y and Z directions for two hours each, i.e. six hours in total. After this test, examine its appearance and functions.
Free fall test in packaged condition	Drop the object, which is packaged as illustrated, to a concrete surface from the height of 90 cm, on one comer, three edges and six faces once each, i.e. 10 times in total. After this test, examine its appearance and functions.
Soldering heat resistance test	After the lead pins of the unit are soaked in solder bath at $260 \pm 5^\circ\text{C}$ for 10 seconds, examine its appearance and functions.
Adhesion test	The device is subjected to be soldered on test PCB. Then apply 0.5 Kg (5N) of force for 5 ± 1 second in the direction of parallel to the substrate (the soldering should be done by reflow and be conducted with care so that the soldering is uniform and free of defect by stress such as heat shock).

2.4GHz Patch Antenna with PCB and Cable Connector

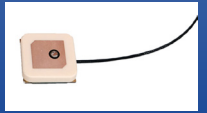

APARC2505-S2450



25.1 x 25.1 x 5.5 mm
RoHS/RoHS II Compliant
MSL = Not Applicable

Packaging

Each carton is of dimension 390 x 320 x 290 mm and has 540 pcs of antenna.

ATTENTION: Abracon LLC's products are COTS – Commercial-Off-The-Shelf products; suitable for Commercial, Industrial and, where designated, Automotive Applications. Abracon's products are not specifically designed for Military, Aviation, Aerospace, Life-dependent Medical applications or any application requiring high reliability where component failure could result in loss of life and/or property. For applications requiring high reliability and/or presenting an extreme operating environment, written consent and authorization from Abracon LLC is required. Please contact Abracon LLC for more information.



5101 Hidden Creek Ln Spicewood TX 78669
Phone: 512-371-6159 | Fax: 512-351-8858
For terms and conditions of sales, please visit:
www.abracon.com

REVISED: 06-13-19

ABRACON IS
ISO9001-2015
CERTIFIED