

10/100/1000 Base-T Single Port SMD LAN Transformer Module

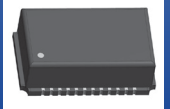

ALANM10001



16.0 x 10.0 x 5.0 mm
17.0 x 16.0 x 5.0 mm
RoHS/RoHS II Compliant
MSL = 1

Features

- Uniform transformer windings
- Fully automated production lines
- Standard 0.99mm and 1.27mm pin pitch
- Meets IEEE 802.3ab standard
- Lead-less SMD construction resistant to tin whiskering
- Multiple schematic and pinout options
- High performance magnetics for EMI suppression and common mode noise rejection
- 5.0mm height

Applications

Communications

- Servers
- Switches
- Routers

Commercial/Industrial

- Video surveillance
- VoIP & IP telecommunications
- Transaction machines
- WiFi gateways

IoT/Consumer

- Smart Lighting
- Smart Appliance

Part Identification

ALANM10001 - [] [] [] []

Package Size
9: 24-Pin option 1*
A: 24-Pin option 2*

Schematic
J11
J01
J10
J00

Operating Temp.
E: 0 °C to +70 °C
D: -40 °C to +85 °C

Packaging
B: Bulk
T: Tape & reel

*Package size option 9: T=850 pcs/reel

*Package size option A: T=600 pcs/reel

10/100/1000 Base-T Single Port SMD LAN Transformer Module

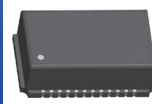

ALANM10001



16.0 x 10.0 x 5.0 mm
17.0 x 16.0 x 5.0 mm
RoHS/RoHS II Compliant
MSL = 1

Electrical Specifications at 25°C

Part Number	Insertion Loss (dB Max)	Return Loss (dB Min)				Crosstalk (dB Min)			CM to CM Rejection Ratio (dB Min)			DM to CM Rejection Ratio (dB Min)		
		0.5-100 MHz	1-40 MHz	60 MHz	80 MHz	100 MHz	30 MHz	60 MHz	100 MHz	30 MHz	60 MHz	100 MHz	30 MHz	60 MHz
ALANM10001-9J11	1.5	16	14	12	10	40	37	33	42	37	33	42	37	33
ALANM10001-9J01	1.5	16	14	12	10	40	37	33	42	37	33	42	37	33
ALANM10001-9J10	1.5	16	14	12	10	40	37	33	42	37	33	42	37	33
ALANM10001-9J00	1.5	16	14	12	10	40	37	33	42	37	33	42	37	33
ALANM10001-AJ11	1.5	16	14	12	10	40	37	33	42	37	33	42	37	33
ALANM10001-AJ01	1.5	16	14	12	10	40	37	33	42	37	33	42	37	33
ALANM10001-AJ10	1.5	16	14	12	10	40	37	33	42	37	33	42	37	33
ALANM10001-AJ00	1.5	16	14	12	10	40	37	33	42	37	33	42	37	33

Part Number	Inductance (uH Min)	Leakage Inductance (uH)	Hi Pot (VDC)	Weight (g)
Test Condition	@100kHz, 0.2V 8mA DC Bias	@ 100kHz Td to Mx	6 sec.	Per Piece
ALANM10001-9J11	200	0.5	1500	1.48
ALANM10001-9J01	200	0.5	1500	1.48
ALANM10001-9J10	200	0.5	1500	1.48
ALANM10001-9J00	200	0.5	1500	1.48
ALANM10001-AJ11	200	0.5	1500	1.68
ALANM10001-AJ01	200	0.5	1500	1.68
ALANM10001-AJ10	200	0.5	1500	1.68
ALANM10001-AJ00	200	0.5	1500	1.68

10/100/1000 Base-T Single Port SMD LAN Transformer Module



ALANM10001



16.0 x 10.0 x 5.0 mm
17.0 x 16.0 x 5.0 mm
RoHS/RoHS II Compliant
MSL = 1

Mechanical Dimensions

9: 24-pin (Option 1)

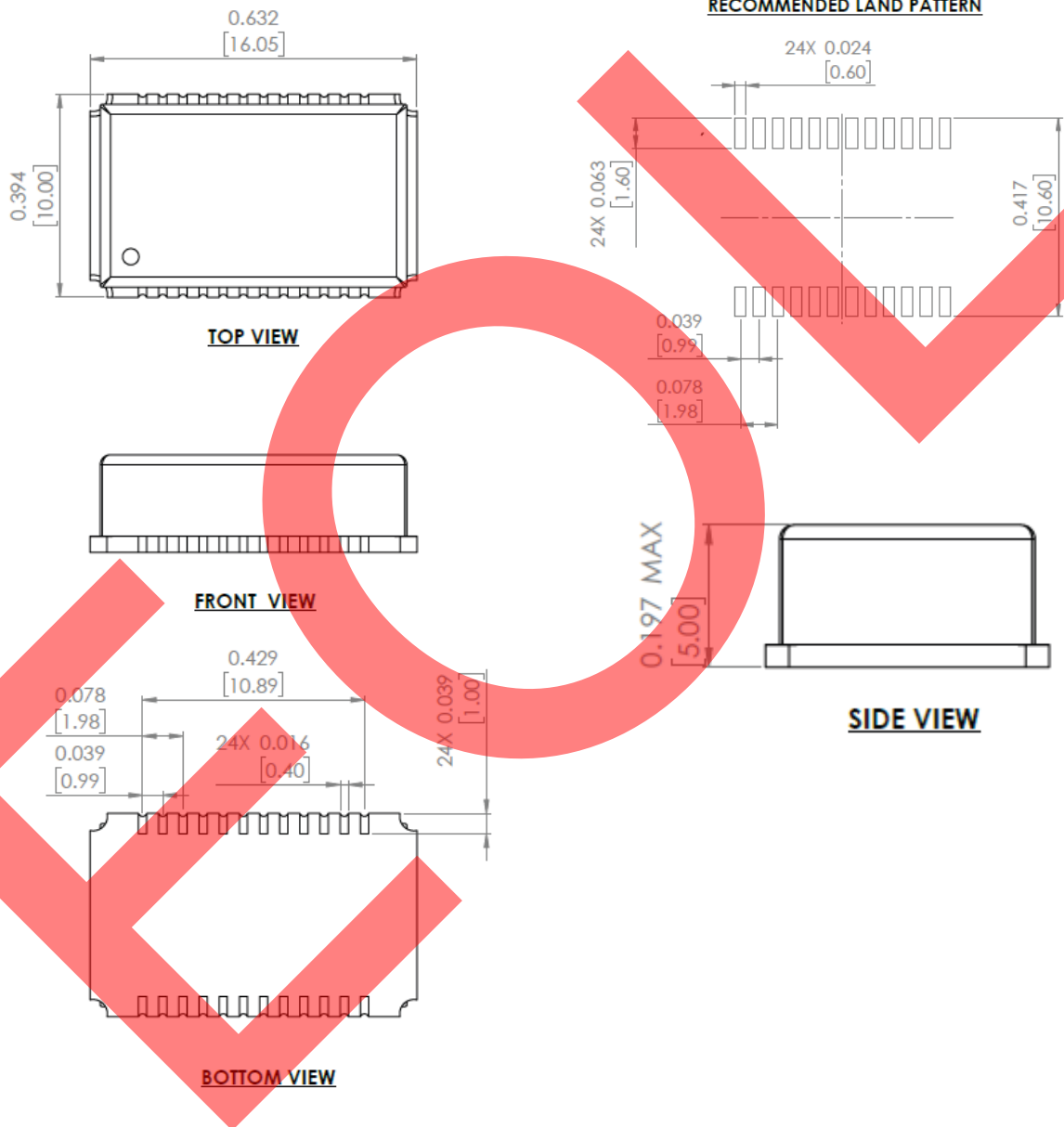

Unless otherwise specified, all tolerances are ± 0.25 in mm
Dimensions: mm



5101 Hidden Creek Ln Spicewood TX 78669
Phone: 512-371-6159 | Fax: 512-351-8858
For terms and conditions of sales, please visit:
www.abracon.com

REVISED: 05-6-19

ABRACON IS
ISO9001-2015
CERTIFIED

10/100/1000 Base-T Single Port SMD LAN Transformer Module



ALANM10001



16.0 x 10.0 x 5.0 mm
17.0 x 16.0 x 5.0 mm
RoHS/RoHS II Compliant
MSL = 1

Mechanical Dimensions

A: 24-pin (Option 2)

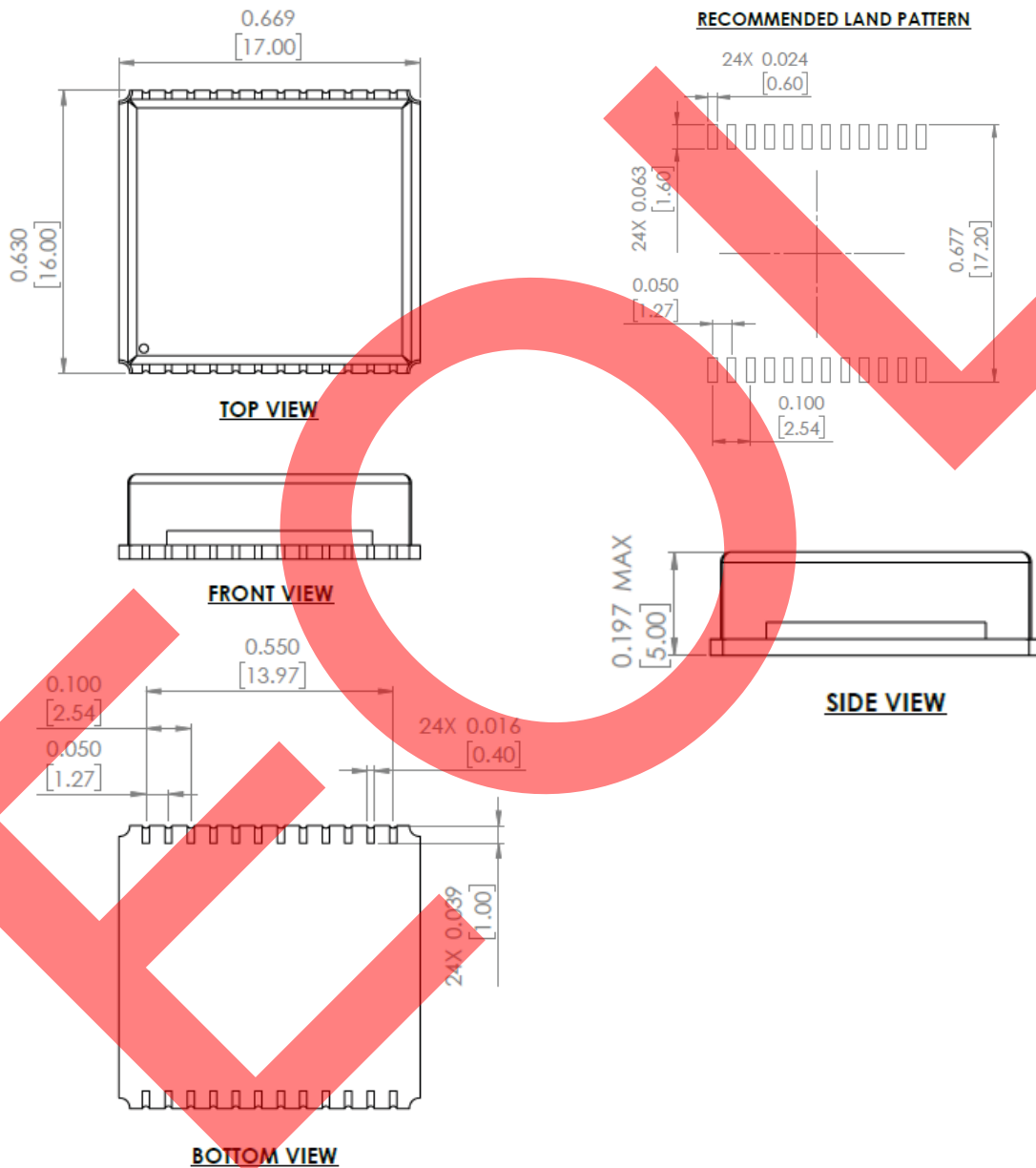

Unless otherwise specified, all tolerances are ± 0.25 in mm
Dimensions: mm

10/100/1000 Base-T Single Port SMD LAN Transformer Module

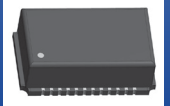

ALANM10001



16.0 x 10.0 x 5.0 mm
17.0 x 16.0 x 5.0 mm
RoHS/RoHS II Compliant
MSL = 1

Schematics

24-pin

J11

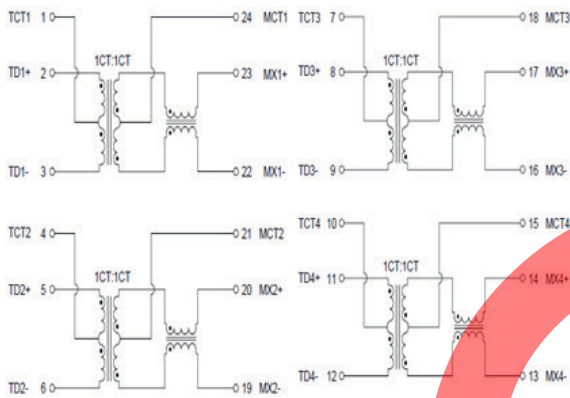

J01

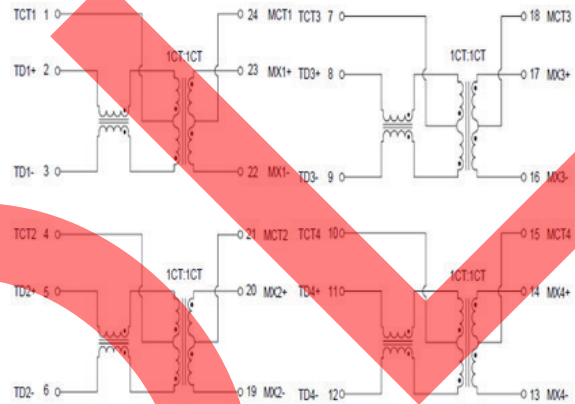

J10

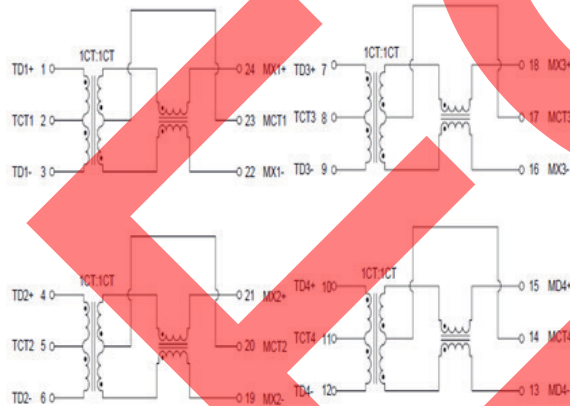

J00

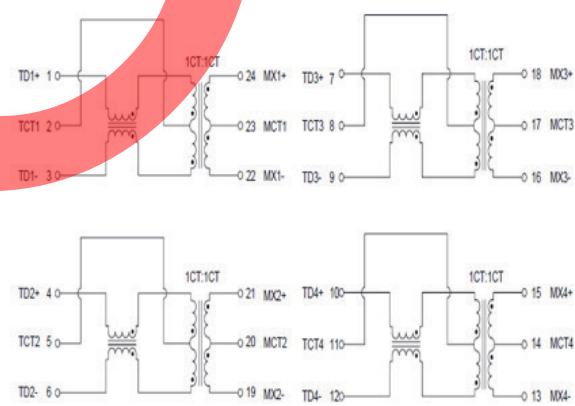

10/100/1000 Base-T Single Port SMD LAN Transformer Module



ALANM10001



16.0 x 10.0 x 5.0 mm
 17.0 x 16.0 x 5.0 mm
 RoHS/RoHS II Compliant
 MSL = 1

Reflow Profile

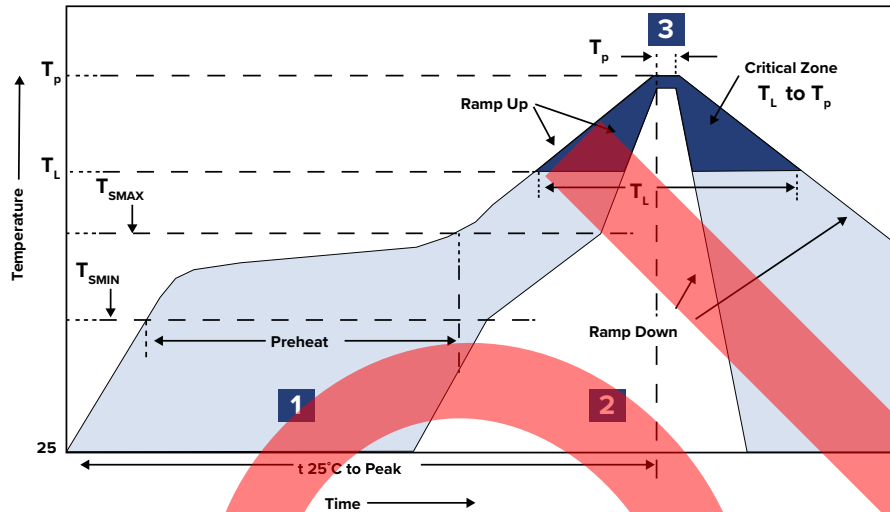

Zone	Description	Temperature	Time
1	Preheat / Soak	$T_{SMIN} \sim T_{SMAX}$ 150°C ~ 200°C	60 ~ 180 sec.
2	Reflow	T_L 245°C	20 ~ 40 sec.
3	Peak heat	T_P 260°C ± 5°C	10 sec. MAX

Packaging

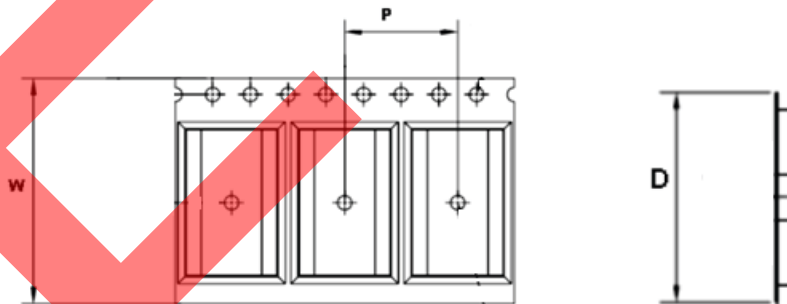

Mechanical Dimension Option	Pcs/reel	W	P	D
9: 24-pin option 1	850	24.0	16.0	Ø330
A: 24-pin option 2	600	32.0	20.0	Ø330