



Atx Led Consultants Inc
1108 Lavaca St – STE 110-489
Austin Tx, 78701
512 377 6052

<http://atx-led.com>

[Click for the FAQ on this product](#)

ATX LED Hub

DA bus master
System Hub

SML case format

Hue emulation,
home automation,
white and tunable white

SML or
DIN rail mounting

Second DA bus and DMX512 output optional

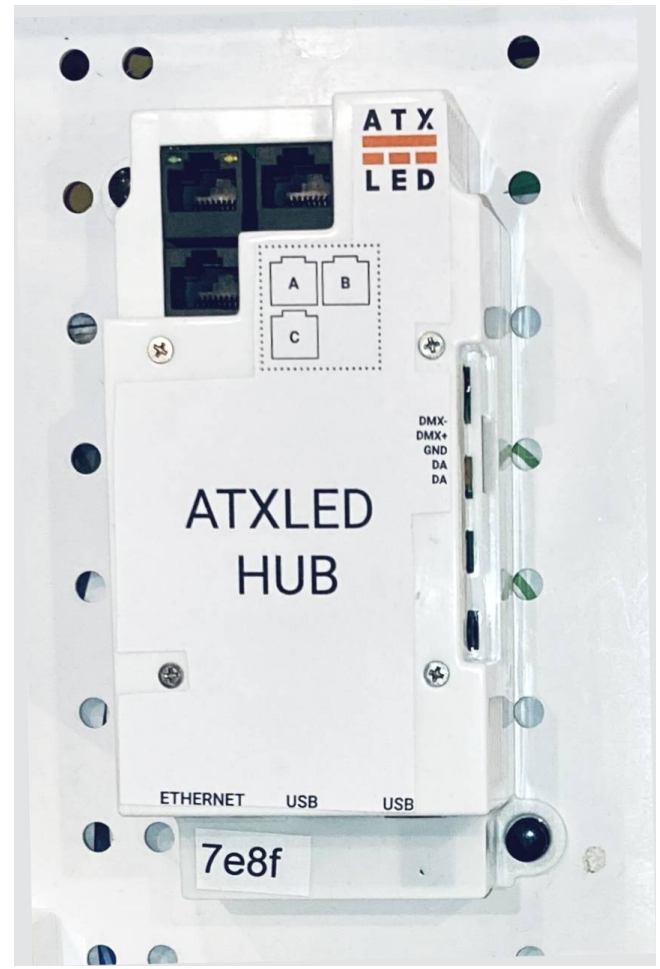

Product Description - ATX LED Hub

This hub manages a DALI lighting system. It can operate stand alone or can connect a DALI bus with the Cloud. It assigns useful names to the physical addresses of each driver, and allows all DALI features of the drivers to be configured by any user. If cloud enabled, it allows access to Alexa, Google and Siri for home automation. The main user friendly features of this device are:

- Assign persistent friendly names to each DALI switch or DALI driver
- Synchronize names and status with Alexa / Google Home
- Create/Edit/View Scenes and Groups
- Turn on/off any device, set brightness, fade rate, minimum/maximum levels
- Create schedules and macros, support API calls
- Connect with DMX devices via AL-DALI-DMX
- Control tunable white with DT8
- Set special modes like Fan timers, 3-Way switching
- Detect power outages and manage as needed
- Powered by Passive PoE cable

Local Management

This device connects by Ethernet or WiFi to your network. Then, you can connect to it to access the management pages. Examples are shown below: Use any web browser.

Hue Emulation

After assigning names to wall switch or fixture, the device will appear to the Hue App as a Hue Bridge with the names of the lights that you created.

Schedules and timers and macros

Use the built in scheduling or use Cloud apps for advanced controls. Run Python scripts as you like.

Technical Features

- Passive PoE Power from RJ45 44 to 56 volts, 300 mA required – can use A, B or C inputs
- Primary DALI bus for 64 addresses, 16 groups, 16 scenes, configurable DALI power source, non isolated
- Secondary (optional) DALI bus for 64 more addresses, 16 groups, 16 scenes, Isolated
- DALI bus power source. Software selectable as Off, 80 mA or 200 mA. 16 volt open circuit, 15v fully loaded.
- Monitoring of the 48v inputs. The System reports the status of power on pins 4 and 5 of the RJ45
A – 50 mV precision individually on pins 4 and 5
B and C – On/Off status of pins 3, 4 and 5
- Programmable Fan with internal set point
- DMX512 input/output on the green connector (optional)

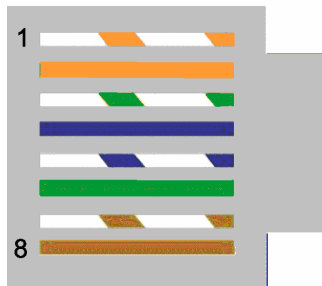
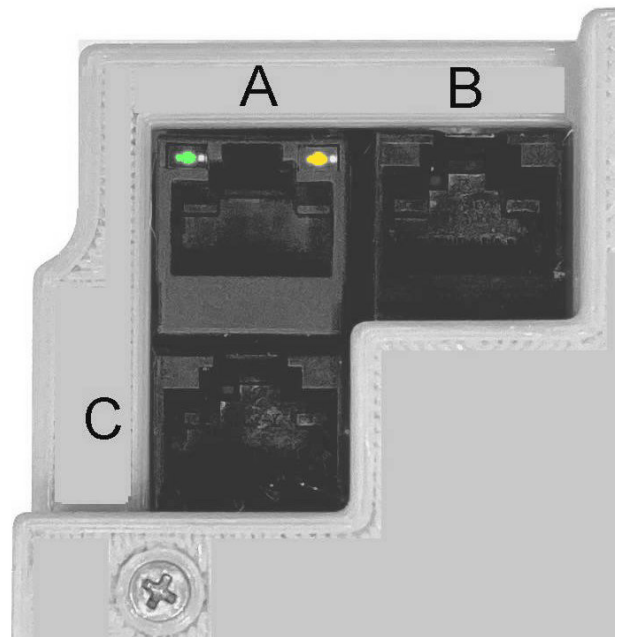

Pin	A	B	C
1	DALI +	DALI +	DALI +
2	DALI – (gnd)	DALI – (gnd)	DALI – (gnd)
3	NC	NC	+ Voltage C1
4	+ Voltage A1	+ Voltage B1	+ Voltage C2
5	+ Voltage A2	+ Voltage B2	+ Voltage C3
6	Ground	Ground	Ground
7	Ground	Ground	Ground
8	Ground	Ground	Ground

Power to the ATX LED Hub, Monitoring and Failover

Apply power using the Rj45 connector cable – this device uses passive PoE. Power sources are the AL-DALI-8-sml, AL-DF10, AL-DALI-6-sbk. The device operates from 24 to 56 volts and 12 watts max (including the Pi). The 7 power inputs on the Rj45 are designed for redundancy – the board will operate with any connected, and will signal to the Pi which are operational.

Inputs B1, B2, C1, C2, C3 are 1 mA loads. The level is measured as 1 if > 20 volts and 0 if less than 9 volts

Power Input	Method	Accuracy	Raspberry Pi port
A1	Serial Port	50 mV	NA
A2	Serial Port	50 mV	NA
B1	GPIO Port	On/Off	GPIO6 / pin 31
B2	GPIO Port	On/Off	GPIO26 / pin 37
C1	GPIO Port	On/Off	GPIO5 / pin 29
C2	GPIO Port	On/Off	GPIO22 / pin15
C3	GPIO Port	On/Off	GPIO27 / pin 13

Powered DALI bus #1 connection

The RJ45 connector also has DALI data. You can use an external DALI power supply, or the internal one. Observe the + and – polarity if more than one DALI power supply is active on the same bus.

DALI bus power – automatic maximum current

The ATX LED HUB has an on-board DALI power supply with 0, 65 or 200 mA. If you elect to connect multiple DALI power supplies in parallel – then please observe the polarity. The Hub measures the DALI line at power up, and adjusts the on-board supply to insure that at least 65 mA is available, and not more than 260 mA. This feature can be managed in software.

Isolated DALI bus #2 connection

The device has a 2nd DALI port. This is isolated and polarity insensitive. Contact the factory for activation of this 2nd DALI port

DMX512 port

The Device has a RS485 port that can be used for DMX512 operation. Contact the factory for activation of this DMX port

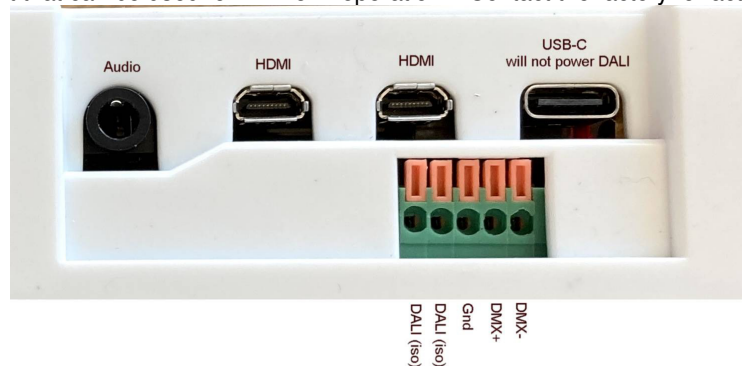

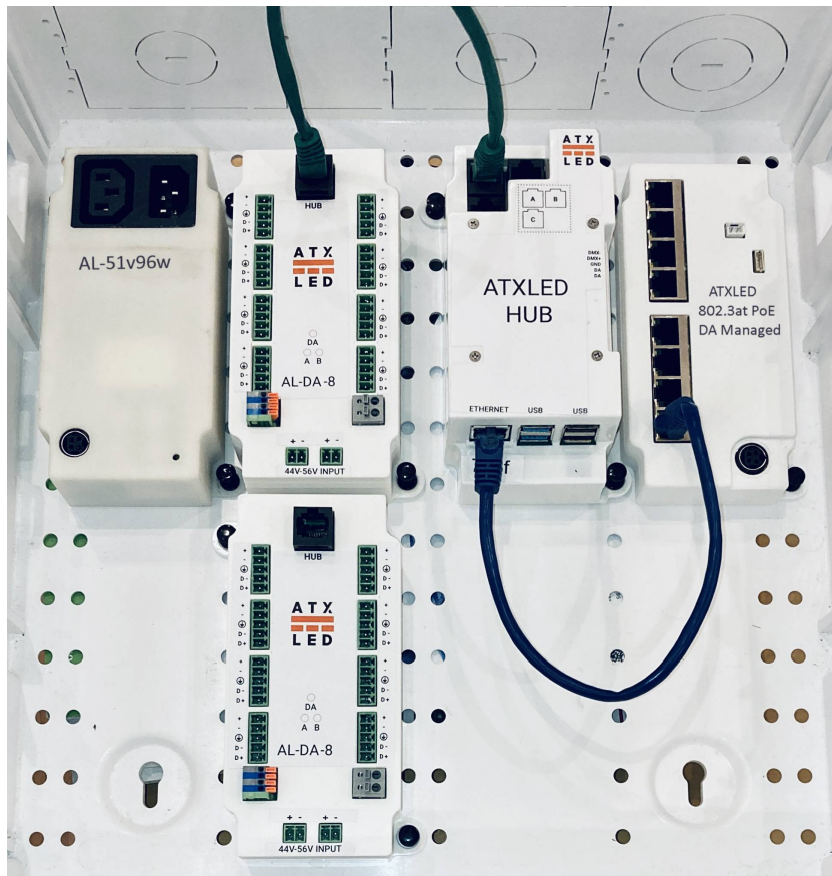

Raspberry Pi

The ATX LED Hub uses a Raspberry Pi Linux computer. We provide the power 5 volts 10 watts to the Pi.

First Time use – WiFi and Internet

Connect the Hub to the power source, Connect the Ethernet port to your home network, or use the WiFi built-in. See <https://atxled.wiki.zoho.com/public/Changing-the-SSID.html>

Once connected: go to the following web site from the same WiFi or LAN network: <http://me.atxled.com> – this will redirect you to the ZWD application that runs on the Hub. If you are not on the same network – you will get an error message. Visit the WiFi page and connect to your home WiFi network, or use the Ethernet port

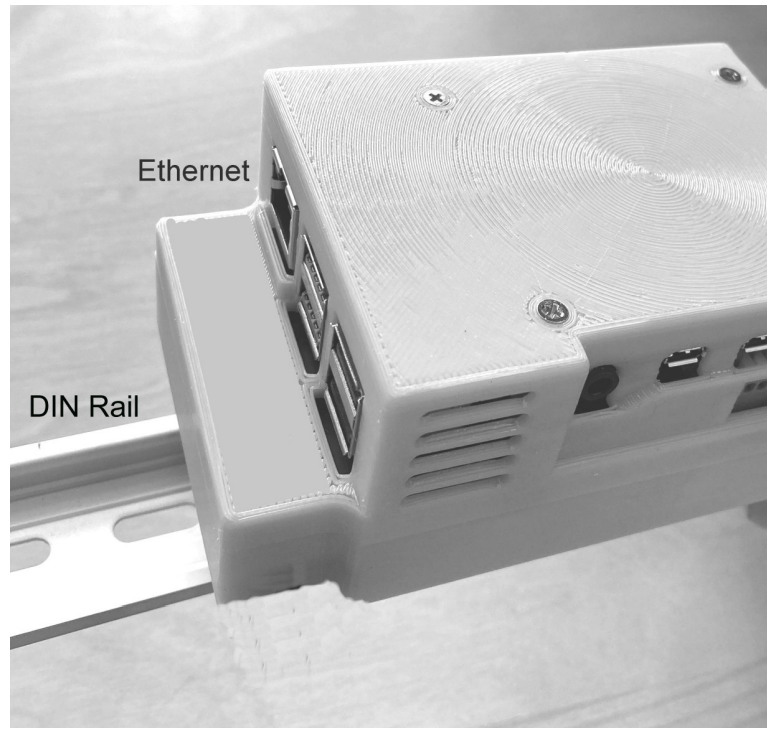

First Time use – DALI bus provisioning

Once in the Hub – go to the **Admin** tab and click on update to assure you have the latest version. Then in the section **Provisioning** click on **Address Assignment** to find and set the addressing of the DALI devices. From the factory – DALI devices only respond to Broadcast commands. Provisioning assigns a short address to factory defaulted drivers. After a short address has been assigned, the drivers will appear in the **Devices** tab, then you can give these devices names. Two names are assigned for each device, a name for the installation, and a name you wish to use for Alexa / Google / Siri. Leave the Alexa et all name blank to hide it from cloud management.

Connect via Hue to Alexa, Siri, Google and remote diagnostics

With Hub configured with devices and names – you can now enable Cloud management. See <https://atxled.com/Hue> for details.

For controlling your lights when not at home, our recommendation is to use the Smartthings hub from Samsung. See <https://atxled.com/SmartThings>

For advanced users, to manage this device remotely – please create an account with the service <https://dataplicity.com>. For tech support from ATX LED – we will need you to set up Dataplicity and give us access remotely.

Sample Web Pages

The screenshot shows the ATX-LED web interface. At the top, there's a logo for ATX-LED, a clock icon, a 'Show More Devices' button, the text '815 Brazos Residence', and a gear icon. Below this is a brightness slider. The main area contains a grid of 16 light controls, each with an 'ON' or 'OFF' button and a percentage indicator. The controls are: Kitchen 100%, Living 80%, Study 75%, Garage 100%, Master 0%, Kids 0%, Entrance 0%, DALI driver 0%, Group A 77%, Group B 0%, Scene A 10 minutes ago, and Scene B 2 hours ago.

The screenshot shows the Hue Emulation mobile app. It features a 'Hue Bridges' section with a 'Philips hue' bridge connected. The main area is titled 'Bulbs' and lists several light fixtures: Desk ATX-LED, Kitchen ATX-LED, Laynew ATX-LED, Light 16 ATX-LED, and DR2F ATX-LED. Each fixture has a slider control. On the right, there's a 'Hue Bridges' sidebar showing connection status, security, IP address (192.168.5.39), MAC address (BB:27:EE:81:11:11), and SW version (1934129020). There are also buttons for 'Clean up' and 'Network settings'.

The screenshot shows the ATX-LED Control Panel (1608 ADU) configuration page. On the left is a sidebar with categories: DALI Devices, Other DALI, Groups, Scenes, Schedule, Triggers, DMX Groups, Hue, Admin, Support, WiFi Setup, DALI Log, Advanced, ZWave, and ZWave Logs. The main area shows configuration for 'DR2G 2x6' with various sliders and buttons. A 'Status' section shows details like Channel: 1, Short address: 25, Model ID, UPC, Serial #: 0, FW Version: 187, HW Version: 5, and Phy Min Level: 145. There's also a 'Tools' section with an 'Update Server' button.

The screenshot shows the ATX-LED Control Panel (1608 ADU) Schedule configuration page. It has buttons for 'Export', 'Choose File', 'No file chosen', and 'Import'. There's a 'New Entry' button and a 'Delete Entry' button. The 'Schedule' section shows a 'sunrise' scene with a 'Sunset' trigger. The 'When?' dropdown is set to 'Sunset' and the 'Offset' is 10 minutes after. The 'On weekdays' section is checked for M, Tu, W, Th, F, Sa, and Su. The 'Actions' section shows sliders for Deck, Garden, Entrance, and Master, each with a red minus button.

The screenshot shows the ATX-LED Control Panel (1608 ADU) Admin configuration page. The sidebar is the same as in the previous screenshot. The main area shows 'Status' information: ZPDS version: 0133-94f577d, Channel: 1, H1 type: 1, H1 version: 02, FW version: 08, DALI power status: mode: 88 mA (locked), voltage: 15.715V, current (at 0v): 0.042A, current (at 0v, peak): 0.170A, current (at 0v, final): 0.176A, Hot power status: voltage A: 47.6V, voltage B: 47.6V, Local IP Address: 192.168.1.119, MAC Address: b827ebc65a6c. There's a 'Site Name' field with '1608 ADU' and a 'Save' button. The 'Provisioning' section has buttons for 'Rescan Addresses', 'Assign Addresses', and 'Assign Addresses (quick)'. A warning message states: 'This address assignment is faster, by skipping devices that already have short at the same short address, so won't always be correct.' The 'Manual address reassignment' section has a 'WARNING: only use this if you know what you're doing!' and a 'DALI Channel' dropdown set to 1, with 'Old Address', 'New Address', and 'Re-assign Address' buttons.

The screenshot shows the ATX-LED Control Panel (1608 ADU) Groups configuration page. The sidebar is the same. The main area shows 'DALI Devices' and 'DMX Devices'. Under 'Groups', there are two groups: 'Group 0' (Deck, Garden, Entrance) and 'Group 2' (Living, Kitchen). Each group has a slider control.

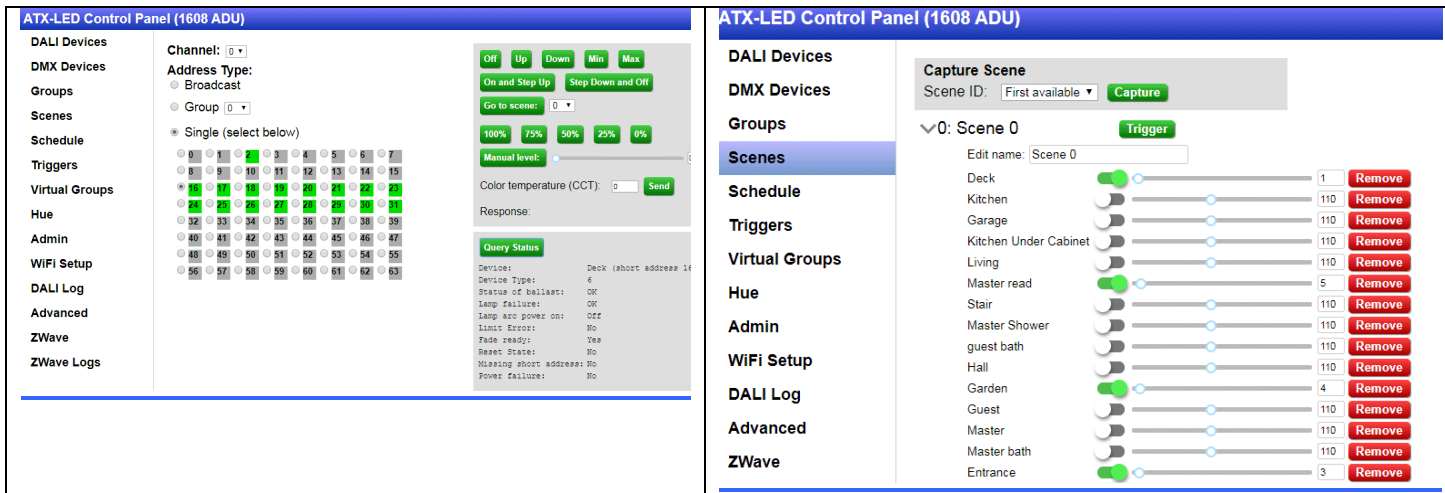

[API for custom applications](#)

Knowledgeable users can write a python or other program to transmit and receive DALI commands using an API. See http://atxled.com/Pi/API_OnOff.py. An example of a shell command is this:

```
curl -XPOST -d '{"channel":0,"commands":["hFE00","h0AFE"]}' -H
"Content-Type: application/json" http://localhost/dali/api/send-raw
```

please see the AL-DALI-HAT data sheet for the format of these commands. One or many DALI commands can be sent with one API call. In this example, two commands are sent. FE 00 turns all lights off. 0A FE sets light at address 5 to 254. The API sends the commands and returns a response. The processing time is about 25 ms per command. The above examples will return "N,N" meaning 2 commands were sent and neither had a response. A response is formatted as a Jxx where xx is the 8 bit response. For the one channel device – the only value is 0 (for 2, and 4 channel hats – the values are 0,1 or 0,1,2,3 respectively)

Packets from the Hat to the Pi

(page 1)

At all times – the AL-DALI-HAT is listening to the DALI bus. Any commands on the bus will be forwarded to the Pi for recording the state of the DALI bus. Also status changes are sent.

The packets sent to the Pi start with a Capital Letter followed by values without commas:

- B means reboot, followed by 6 characters, HW version (2), SW version (2), channel count (2). This device has 1 channel
- D means DALI bus power supply status, 2 characters follow (one byte with status, then one byte = one channel => 1)
- H means receipt of a 16 bit DALI packet, 4 Hex characters follow
- J means receipt of an 8 bit DALI packet, 2 Hex characters follow
- L means receipt of a 24 bit DALI packet, 6 Hex characters follow
- N means no response received – normal in most cases (DALI NAK)
- M means receipt of a 25 bit DALI packet, 8 Hex characters follow (fw 18 or later)
- P is for power status, 2 voltage inputs plus the onboard switch status, 5 characters
- Q is for DALI bus quality – sent if major changes are detected. 16 characters
- S is the String stored in EEPROM (bytes 1-30)
- T is the String stored in EEPROM if longer than 30 bytes(bytes 31-59)
- U is the logic 0 voltage sensed during the last remote bus packet. Test quality of LED drivers
- V same values as B
- W calibrate voltages
- X means bus collision on Receive– normal in most cases
- Z means bus collision on Transmit– normal in most cases

The DALI power supply state is also sent proactively by the HAT if the DALI bus changes readiness

- D01 = no power on DALI , one channel
- D11 = Bus current too high – cannot drive to zero, one channel
- D21 = DALI bus OK, one channel
- D41 = Bus voltage > 24 volts, one channel

The DALI power supply quality response to the Q command is 16 characters and encoded as (Qmvvvvvxxxxyyyzzz)

- m = internal DALI power supply setting – see table above
- vvvvv = DALI Voltage – in millivolts (5 digits)
- xxx = DALI current in mA when bus is at 0 volts (3 digits)
- yyyy = DALI current in mA when bus is at 6.2 volts (initial – 4 digits)
- zzz = DALI current in mA when bus is at 6.2 volts (after 10 milliseconds – 3 digits)
- if the Bus falls below 12 volts – a packet will be set with yyyy and zzz == 999 indicating an error
- if the Bus Current changes by more than 60 mA – a packet will be set with yyyy and zzz == 888

The HAT version status info is encoded as (Vxxyzz) (V is replaced by B when the HAT restarts)

- xx = Hardware Version
- yy = Firmware Version (decimal = 32 is 32 not 50)
- 01 = Hardware Type (see the wiki for Hardware types)

The HAT status info is encoded as (Pxxxyyz) and is sent when a 500 mV change is detected.

- xxx = Power line A voltage (tenths of volts)
- yyy = Power line B voltage (tenths of volts)
- z = 0 or 1 for the Switch On/Off status

Packets from the Hat to the Pi

(page 2)

A remote DALI devices ability to drive the DALI Bus current to a logic low value is captured and available as (Uxxxxxyyyy0000). Query a remote device so it sends a response, then send the U command to the Hat to report the logic zero level received.

- xxxxx = DALI bus logic 0 level in mV when the HAT drives the bus
- yyyy = DALI Bus logic 0 level in mV when a remote device drives the bus

Collisions on the DALI bus are expected during address search, but there are cases that are not expected. Check for lower than specified DALI bus voltages, higher currents than specified, or longer line lengths, the AL-DALI-Hat reports these errors.

- X4 = packet length error
- X3 = short bit received
- X2 = multiple packets received
- Z = Collision on transmit – normal, command should be resent

If there is no response to a packet after 100 ms – then a collision has occurred.

HAT to Pi	Structure	Xx	yy	cc	zz
B Boot	Bxyycc	HW Version	FW Version	Switch	
H DALI 16 bit	Hxyy	DALI byte 0	DALI byte 1		
F Forwarding	See Forwarding				
J DALI 8 bit	Jxx	DALI byte			
L DALI 24 bit	Lxyycc	DALI byte 0	DALI byte 1	DALI byte 2	
M DALI 25 bit	Mxyycczz	DALI byte 0	DALI byte 1	DALI byte 2	DALI byte 3
N No Response	N				
P Power Status	Pxyyzz	0	0	Switch on/off	
Q Query	Q	N/A			
S Key Storage	S	See Key storage			
V Version	Vxyycc	HW Version	FW Version	Switch	
X Collision on Receive	Xx				
Z Collision on Transmit	Zxx				
Other Collision	Null response				

Packets from the Pi to the HAT

The AL-DALI-HAT receives serial port strings from Pi and forwards them to the DALI bus. The packet is 2, 4, or 6 bytes long and begins with one of these characters. Length is the number of characters after the Command

:

Command	Length	Command type	Example
h	4	Send 16 bit DALI	hFE00\n all off
t	4	Send 16 bit DALI twice	t1120\n reset SA 8
j	2	Send 8 bit DALI	j80\n
l	6	Send 24 bit DALI	l101010\n
m	8	Send 25 bit DALI	M1101010\n
r *	5	Set DMX universe byte	r01055 set address 10 = 55
	8	Set DMX universe bytes	R10055033 set address 100:132 = 55
D	0	Query DALI bus info	d\n
p	0	Query Power info	p\n
v	0	Query Version	v\n
u	0	Query last DALI low	u\n
q	0	Query Quality	q\n
	1	Set Power modes	q1\n
s	0	Query Text String	s\n
sxxxxxx	Up to 59	Save Text string – erase prior contents	Sabcdef\n
	1	Query Calibration	W7\n
w	5	Set Calibration +-xxxx mV	w8xxxx A side w9xxxx B side

r* response is OK if DMX is available on the hardware

On receipt, the AL-DALI-HAT will wait for the DALI bus to be non busy, then will transmit the command. In the case of the t command – it will send the data twice within 100 ms.

DALI bus products from ATX LED Consultants

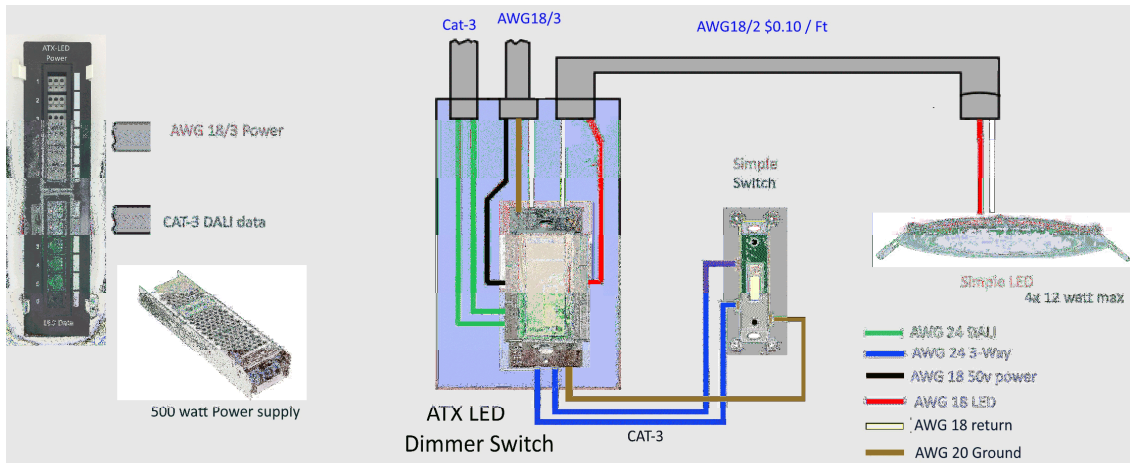

Low Voltage house lighting product line

