

# WIRE WOUND INDUCTOR - CERAMIC or FERRITE

**AISC-0805(F)**

 RoHS/RoHS II compliant

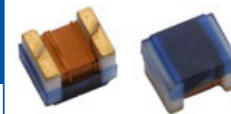

2.29 x 1.73 x 1.55mm

▷ **FEATURES:**

- Ceramic or Ferrite Construction assures the utmost in the thermal stability and high SRF
- Exceptionally high Q compared to non-wirewound inductor, especially at high frequencies
- Inductance values available from 2.2 nH to 68uH; tight tolerance

▷ **APPLICATIONS:**

- Widely applied in the VCO, SAW circuit for GSM, CDMA communications
- Used in hard disk, notebook computer and other electronic equipment

▷ **STANDARD SPECIFICATIONS:**

Part Number	L(nH) @ Test Freq.	Tolerance (±%)	Q, Min @ Test Freq.	SRF Min (MHz)	R <sub>DC</sub> Max (Ω)	I <sub>DC</sub> Max (mA)
AISC-0805-R0022	2.2 @ 250 MHz	10,20	40 @ 1500 MHz	>6000	0.10	600
AISC-0805-R0033	3.3 @ 250 MHz	5,10,20	30 @ 1500 MHz	>6000	0.08	600
AISC-0805-R0068	6.8 @ 250 MHz	5,10,20	40 @ 1000 MHz	5000	0.11	600
AISC-0805-R0082	8.2 @ 250 MHz	5,10,20	40 @ 1000 MHz	4600	0.19	600
AISC-0805-R012	12 @ 250 MHz	2,5,10,20	40 @ 500 MHz	4000	0.15	600
AISC-0805-R015	15 @ 250 MHz	5,10,20	40 @ 500 MHz	2900	0.17	600
AISC-0805-R018	18 @ 250 MHz	2,5,10,20	50 @ 500 MHz	3300	0.20	600
AISC-0805-R022	22 @ 250 MHz	2,5,10,20	55 @ 500 MHz	2000	0.22	500
AISC-0805-R027	27 @ 250 MHz	2,5,10,20	55 @ 500 MHz	2500	0.25	500
AISC-0805-R033	33 @ 250 MHz	2,5,10,20	60 @ 500MHz	2000	0.27	500
AISC-0805-R039	39 @ 250 MHz	2,5,10,20	60 @ 500MHz	2000	0.29	500
AISC-0805-R047	47 @ 200 MHz	2,5,10,20	50 @ 500MHz	1600	0.31	500
AISC-0805-R056	56 @ 200 MHz	2,5,10,20	55 @ 500MHz	1550	0.32	500
AISC-0805-R068	68 @ 200 MHz	2,5,10,20	55 @ 500MHz	1450	0.38	500
AISC-0805-R082	82 @ 150 MHz	2,5,10,20	50 @ 500MHz	1300	0.42	400
AISC-0805-R10	100 @ 150 MHz	2,5,10,20	50 @ 500MHz	1200	0.46	400
AISC-0805-R12	120 @ 150 MHz	2,5,10,20	50 @ 250 MHz	1100	0.51	400
AISC-0805-R15	150 @ 100 MHz	2,5,10,20	50 @ 250 MHz	920	0.56	400
AISC-0805-R18	180 @ 100 MHz	2,5,10,20	50 @ 250 MHz	870	0.64	400
AISC-0805-R22	220 @ 100 MHz	2,5,10,20	45 @ 250 MHz	850	1.10	400
AISC-0805-R27	270 @ 100 MHz	2,5,10,20	38 @ 250 MHz	650	1.00	350
AISC-0805-R33	330 @ 100 MHz	2,5,10,20	40 @ 250 MHz	600	1.4	310
AISC-0805-R39	390 @ 100 MHz	2,5,10,20	35 @ 250 MHz	560	1.5	290
AISC-0805-R47	470 @ 50 MHz	5,10,20	33 @ 100 MHz	375	1.72	250
AISC-0805-R56	560 @ 25 MHz	5,10,20	23 @ 50 MHz	320	1.9	230
AISC-0805-R62	620 @ 25 MHz	5,10,20	23 @ 50 MHz	280	1.95	200
AISC-0805-R68	680 @ 25 MHz	5,10,20	23 @ 50 MHz	270	2.05	190
AISC-0805-R75	750 @ 25 MHz	5,10,20	23 @ 50 MHz	240	2.1	180
AISC-0805-R82	820 @ 25 MHz	5,10,20	23 @ 50 MHz	250	2.3	180
AISC-0805-R91	910 @ 25 MHz	5,10,20	22 @ 50 MHz	230	2.4	160
AISC-0805-1R0	1000 @ 25 MHz	5,10,20	20 @ 50 MHz	200	2.5	150
AISC-0805F-R27	270@25MHz	5,10,20	15@25MHz	550	0.91	350
AISC-0805F-R47	470@100MHz	5,10,20	8@100MHz	500	0.72	300
AISC-0805F-R56	560@25MHz	5,10,20	15@25MHz	360	0.6	145
AISC-0805F-1R0	1000@7.9MHz	2,5,10,20	15@7.9MHz	63	1.20	245
AISC-0805F-1R5	1500@7.9MHz	2,5,10,20	15@7.9MHz	60	1.45	225
AISC-0805F-1R8	1800@7.9MHz	5,10,20	15@7.9MHz	60	1.45	200
AISC-0805F-2R2	2200@7.9MHz	2,5,10,20	10@50MHz	200	2.50	100
AISC-0805F-3R3	3300@7.9MHz	2,5,10,20	15@7.9MHz	50	2.30	175
AISC-0805F-3R9	3900@7.9MHz	5,10,20	10@7.9MHz	50	2.50	80
AISC-0805F-4R7	4700@7.9MHz	2,5,10,20	15@7.9MHz	43	2.80	140
AISC-0805F-6R8	6800@7.9MHz	2,5,10,20	15@7.9MHz	36	3.40	115
AISC-0805F-8R2	8200@7.9MHz	5,10,20	10@2.5MHz	35	4.50	100

PARAMETERS
ABRACON P/N: AISC-0805(F)-xxx
Operating temperature: -40°C to +125°C
Storage temperature: -10°C to +40°C 70% RH max.

# WIRE WOUND INDUCTOR - CERAMIC or FERRITE

**AISC-0805(F)**

 RoHS/RoHS II compliant

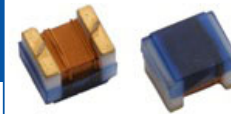

2.29 x 1.73 x 1.55mm

Part Number	L(nH) @Test Freq.	Tolerance (±%)	Q, Min @Test Freq.	SRF Min (MHz)	R <sub>DC</sub> Max (Ω)	I <sub>DC</sub> Max (mA)
AISC-0805F-100	10000@2.5MHz	2,5,10,20	10@2.5MHz	30	4.70	98
AISC-0805F-150	15000@2.5MHz	2,5,10,20	10@2.5MHz	23	6.50	80
AISC-0805F-220	22000@2.5MHz	2,5,10,20	10@2.5MHz	20	8.00	68
AISC-0805F-330	33000@2.5MHz	2,5,10,20	10@2.5MHz	17	10.7	60
AISC-0805F-470	47000@2.5MHz	2,5,10,20	10@2.5MHz	14	13.8	55
AISC-0805F-680	68000@2.5MHz	2,5,10,20	8@2.5MHz	11	17.5	40

## Test Conditions

Inductance (L): Agilent4287A+Agilent16197A or equivalent, 50mV

Direct Current Resistance (DCR): HIOKI 3540 or equivalent

Temperature rise current (I<sub>r</sub>): Electric Power, Electric current meter, Thermometer

I<sub>DC</sub>: Based on temperature rise (ΔT: 20°C)

## ▷ PART IDENTIFICATION:

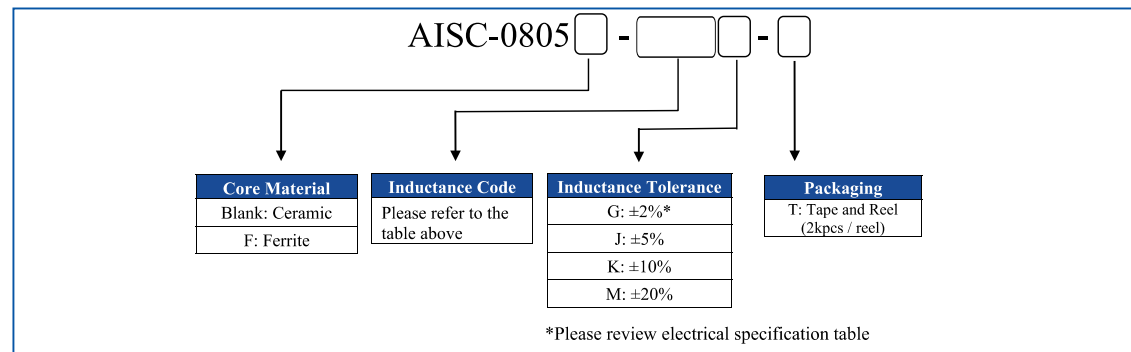

## ▷ OUTLINE DRAWING:

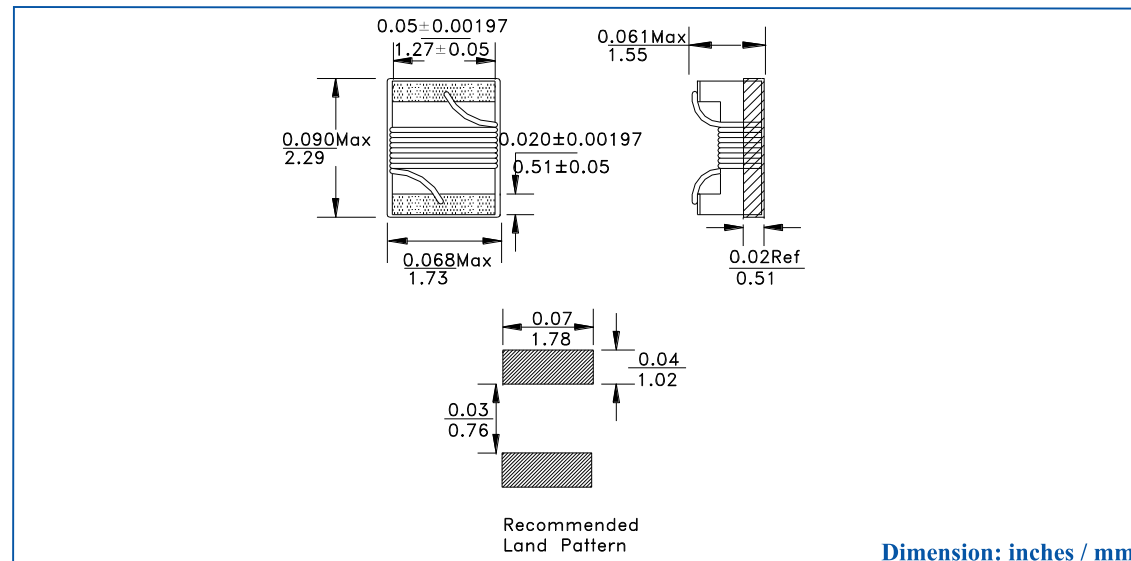

# WIRE WOUND INDUCTOR - CERAMIC or FERRITE

AISC-0805(F)

 RoHS/RoHS II compliant



2.29 x 1.73 x 1.55mm

## REFLOW PROFILE:

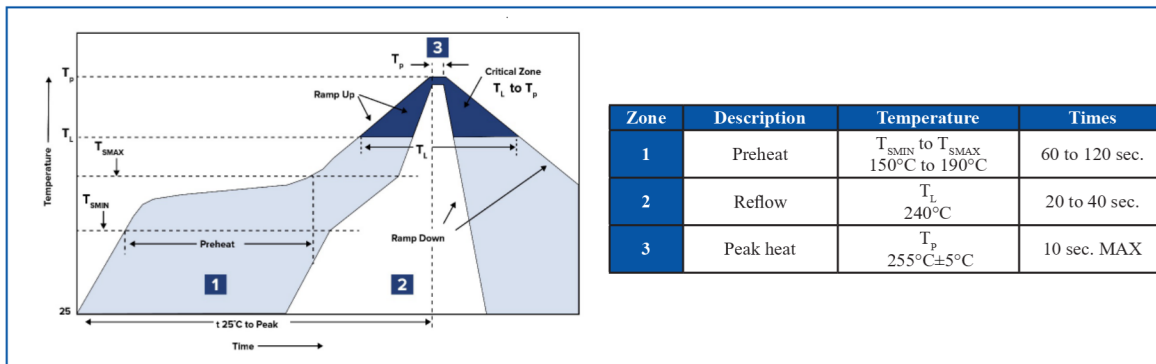

## TAPE & REEL:

T= tape and reel (2,000pcs/reel)

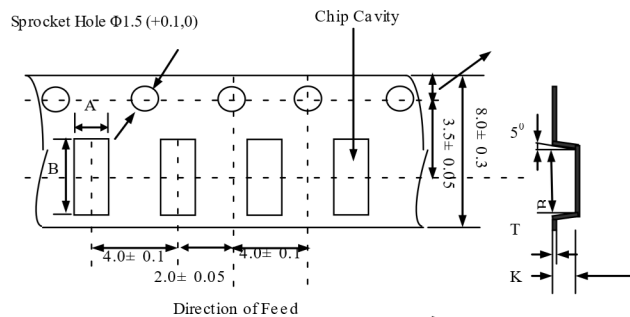

Type	A	B	K	T
2012	1.88±0.2	2.4±0.2	1.35±0.2	0.22±0.1

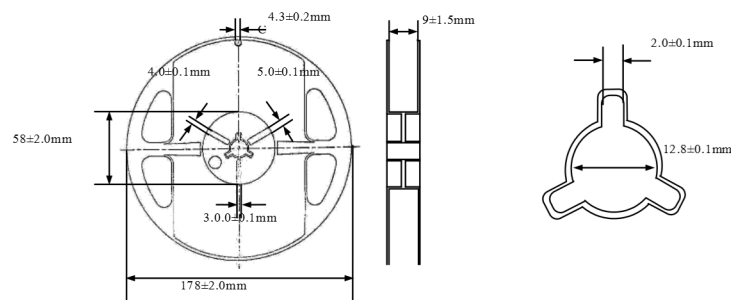

Dimension: mm

**ATTENTION:** Abracon LLC's products are COTS – Commercial-Off-The-Shelf products; suitable for Commercial, Industrial and, where designated, Automotive Applications. Abracon's products are not specifically designed for Military, Aviation, Aerospace, Life-dependant Medical applications or any application requiring high reliability where component failure could result in loss of life and/or property. For applications requiring high reliability and/or presenting an extreme operating environment, written consent and authorization from Abracon LLC is required. Please contact Abracon LLC for more information.