



SKYWOR[®]KS

AGB3301

50Ω High Linearity Low Noise
Wideband Gain Block
Data Sheet

FEATURES

- 250 - 3000 MHz Frequency Range
- +45 dBm Output IP3
- Low Noise Figure: 2.4 dB at 900 MHz
- 13.5 dB Gain at 900 MHz
- +24 dBm P1dB
- SOT-89 Package
- Single +5V to +9V Supply
- Low Power: less than 1 Watt
- Case Temperature: -40 to +100 °C
- RoHS Compliant Package, 260 °C MSL-2

APPLICATIONS

- Cellular Base Stations for W-CDMA, CDMA, TDMA, GSM, PCS and CDPD systems
- Fixed Wireless
- MMDS/WLL
- WLAN, HyperLAN
- CATV

PRODUCT DESCRIPTION

The AGB3301 is one of a series of GaAs MESFET amplifiers designed for use in applications requiring high linearity, low noise and low distortion. With a high output IP3, low noise figure and wide band operation, the AGB3301 is ideal for 50Ω wireless

infrastructure applications such as Cellular Base Stations, MMDS, and WLL. Offered in a low cost SOT-89 surface mount package, the AGB3301 requires a single +5V to +9V supply, and typically consumes less than 1 Watt of power.

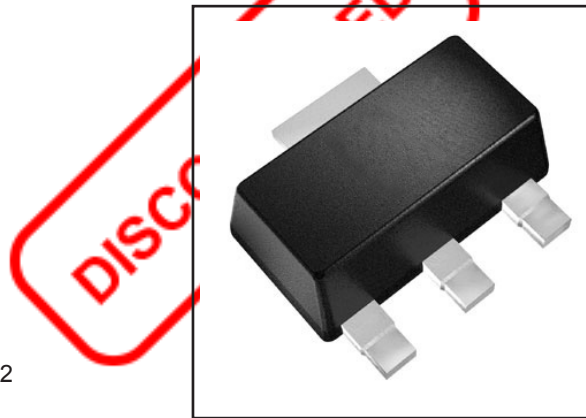

**S24 Package
SOT-89**

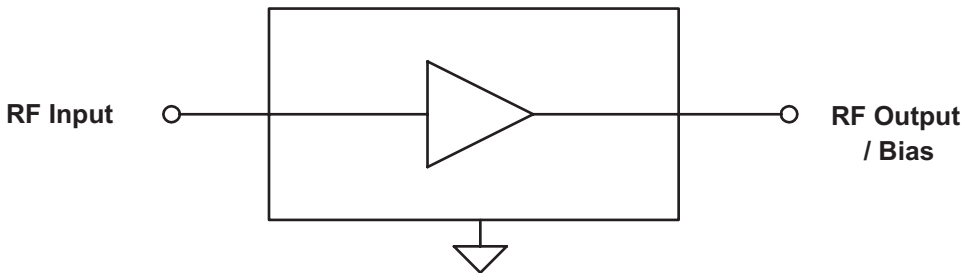

Figure 1: Block Diagram

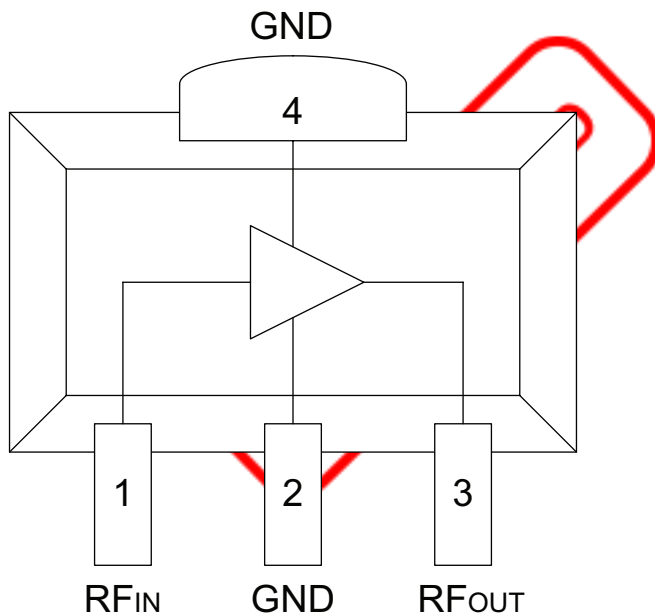

Figure 2: Pin Out

Table 1: Pin Description

PIN	NAME	DESCRIPTION
1	RF _{IN}	RF Input
2	GND	Ground
3	RF _{OUT}	RF Output / Bias
4	GND	Ground

ELECTRICAL CHARACTERISTICS

Table 2: Absolute Minimum and Maximum Ratings

PARAMETER	MIN	MAX	UNIT
Device Voltage	0	+12	VDC
RF Input Power	-	+15	dBm
Storage Temperature	-40	+150	°C
Channel Temperature	-	+150	°C

Stresses in excess of the absolute ratings may cause permanent damage. Functional operation is not implied under these conditions. Exposure to absolute ratings for extended periods of time may adversely affect reliability.

Table 3: Operating Ranges

PARAMETER	MIN	TYP	MAX	UNIT
Operating Frequency: f	250	-	3000	MHz
Device Voltage: V _{DD}	-	+9	+10	VDC
Case Temperature: T _c	-40	-	+100	°C

The device may be operated safely over these conditions; however, parametric performance is guaranteed only over the conditions defined in the electrical specifications.

Table 4: Electrical Specifications - Unmatched 50Ω Test Circuit
 (T_A = +25 °C, V_{DD} = +9 VDC, f = 900 MHz, see Figure 3)

PARAMETER	MIN	TYP	MAX	UNIT
Gain: S ₂₁	12	13.5	15	dB
Input Return Loss: S ₁₁	-	-15	-10	dB
Output Return Loss: S ₂₂	-	-15	-10	dB
Output IP ₃ ⁽¹⁾	+42	+45	-	dBm
Noise Figure	-	2.4	3.5	dB
Output 1dB Compression: P _{1dB}	-	+24	-	dBm
Thermal Resistance: θ _{Jc}	-	-	40	°C/W
Supply Current	90	110	130	mA

Notes:

(1) OIP₃ is measured with two tones: 900 MHz and 901 MHz, +5dBm output per tone.

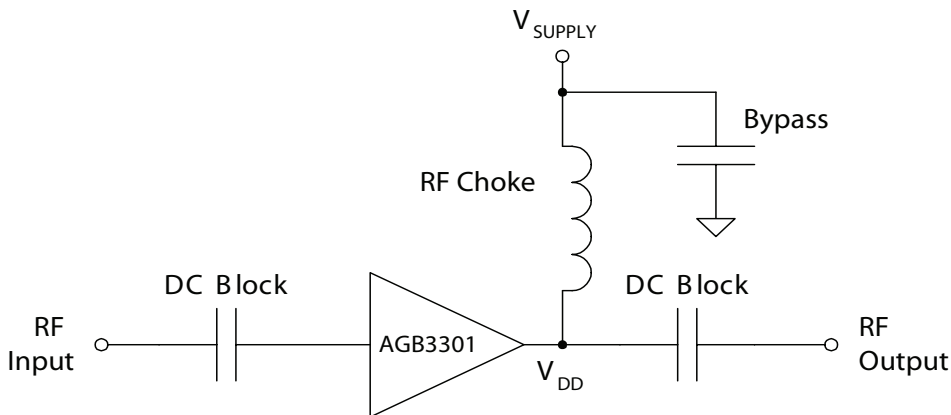
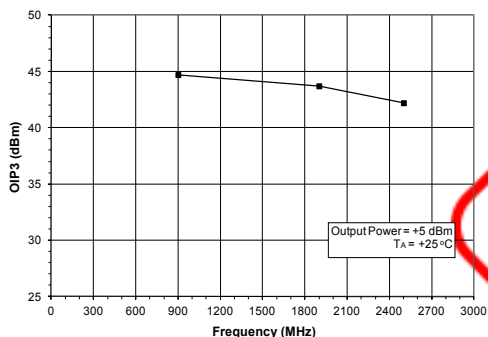

Figure 3: Unmatched 50Ω Test Circuit

PERFORMANCE DATA

Figures 4 through 8 contain data for the device as tested in the unmatched 50Ω test circuit shown in Figure 3. Unless otherwise indicated, $V_{DD} = +9$ VDC.

**Figure 4: OIP3 vs. Frequency
(in Unmatched 50Ω Test Circuit)**



**Figure 5: OIP3 vs. Case Temperature
(in Unmatched 50Ω Test Circuit)**

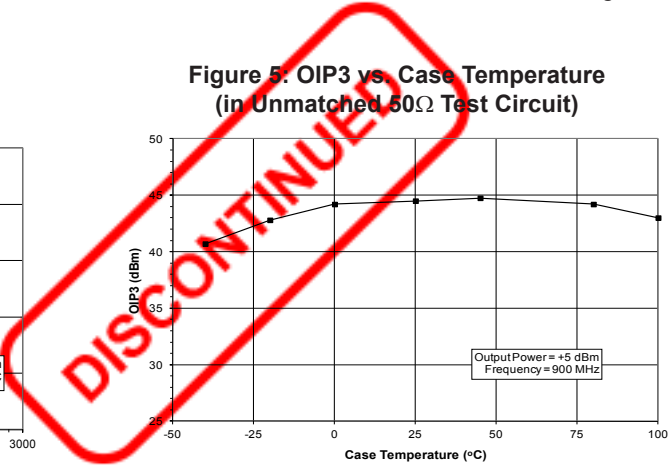

**Figure 6: Gain vs. Frequency
(in Unmatched 50Ω Test Circuit)**

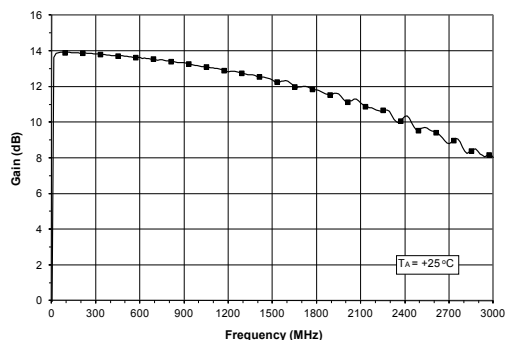

**Figure 7: Gain vs. Case Temperature
(in Unmatched 50Ω Test Circuit)**

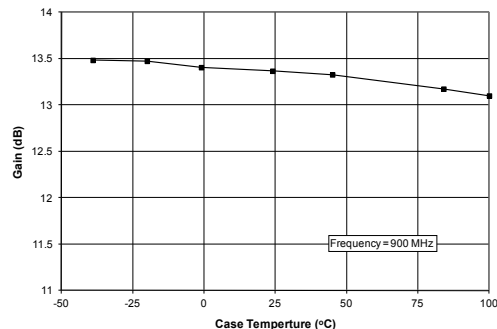

**Figure 8: Return Loss vs. Frequency
(in Unmatched 50Ω Test Circuit)**

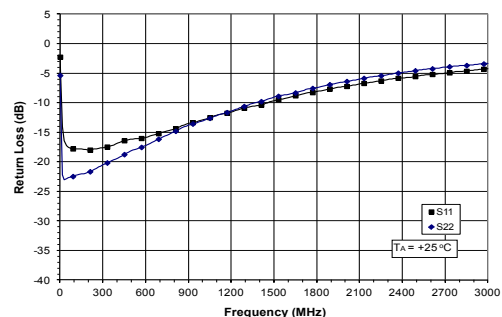

APPLICATION INFORMATION

900 MHz Application: +9V Supply
(824 - 960 MHz)

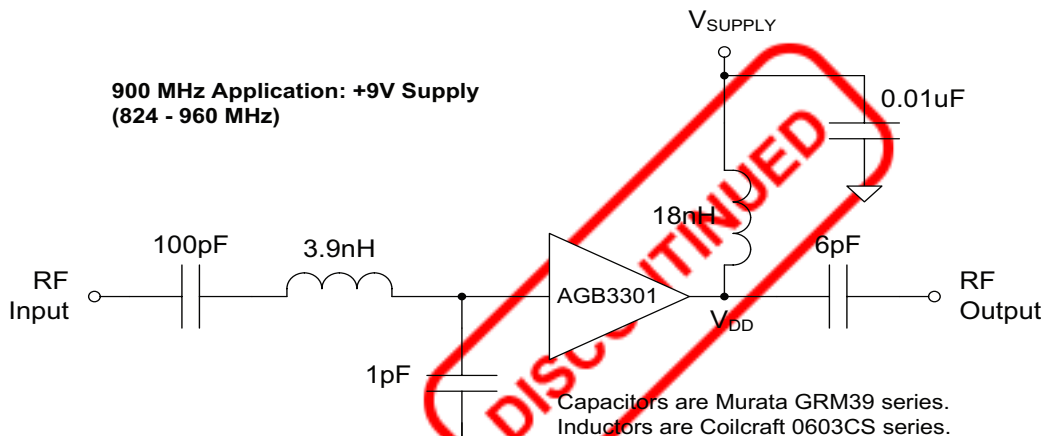

Figure 9: 900 MHz Application Circuit (50Ω Terminations)

Table 5: 900 MHz Application Performance
(V_{SUPPLY} = +9 VDC)

PARAMETER	TYP	UNIT
Gain: S ₂₁	13.8	dB
Input Return Loss: S ₁₁	-20	dB
Output Return Loss: S ₂₂	-18	dB
Output IP ₃ ⁽¹⁾	+47	dBm
Noise Figure	2.4	dB
Output 1dB Compression: P _{1dB}	+24	dBm

Note:

(1) OIP₃ is measured with two tones: 900 MHz and 901 MHz, +5dBm output per tone.

Figure 10: Output 3rd-Order Intercept vs. Power
(V_{SUPPLY} = +9 VDC, 900 MHz Application Circuit)

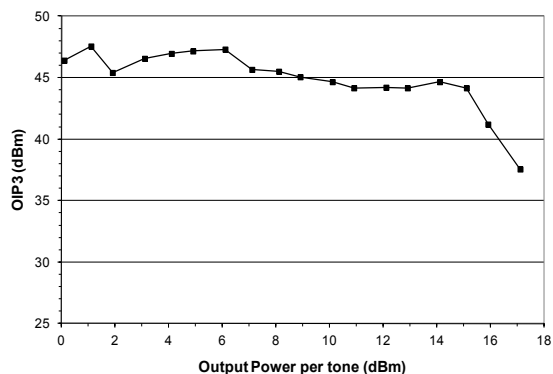

Figure 11: Gain vs. Frequency
(V_{SUPPLY} = +9 VDC, 900 MHz Application Circuit)

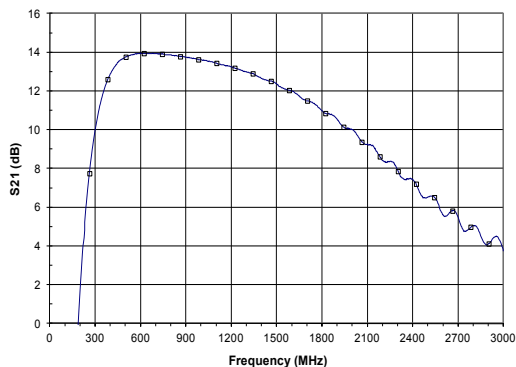
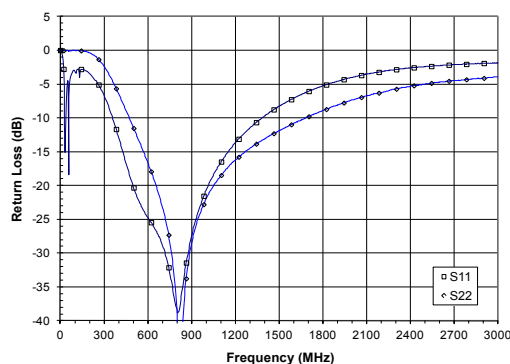

Figure 12: Return Loss vs. Frequency
(V_{SUPPLY} = +9 VDC, 900 MHz Application Circuit)



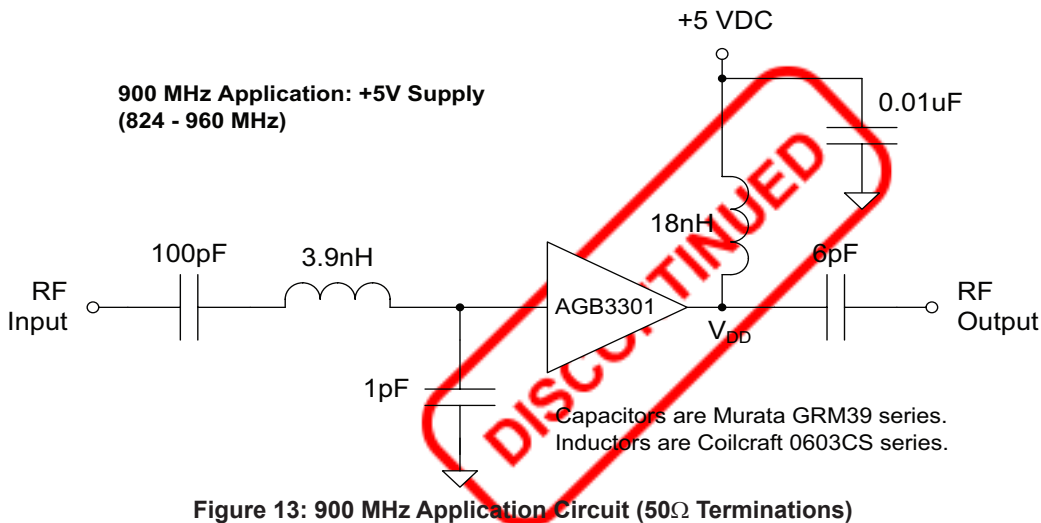

Figure 13: 900 MHz Application Circuit (50Ω Terminations)

Table 6: 900 MHz Application Performance (V_{SUPPLY} = +5 VDC)

PARAMETER	TYP	UNIT
Gain: S ₂₁	13.5	dB
Input Return Loss: S ₁₁	-20	dB
Output Return Loss: S ₂₂	-20	dB
Output IP3 ⁽¹⁾	+42.5	dBm
Noise Figure	2.5	dB
Output 1dB Compression: P1dB	+18.5	dBm

Note:

(1) OIP3 is measured with two tones: 900 MHz and 901 MHz, +5dBm output per tone.

Figure 14: Output 3rd-Order Intercept vs. Power (V_{SUPPLY} = +5 VDC, 900 MHz Application Circuit)

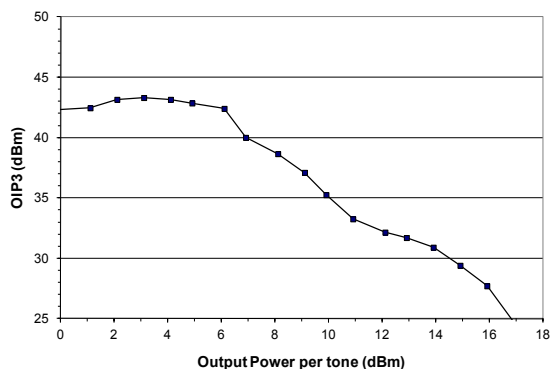

Figure 15: Gain vs. Frequency (V_{SUPPLY} = +5 VDC, 900 MHz Application Circuit)

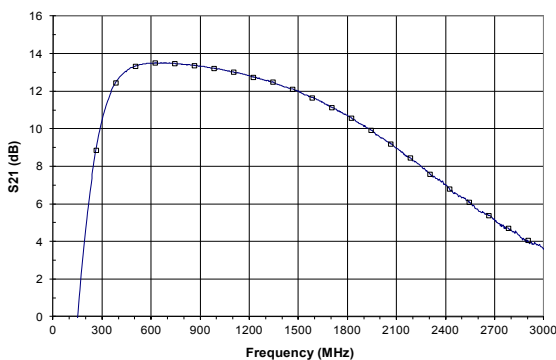
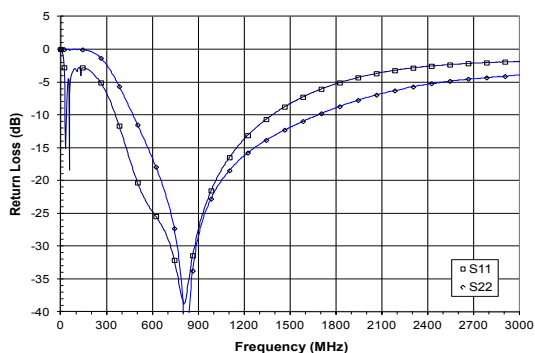

Figure 16: Return Loss vs. Frequency (V_{SUPPLY} = +5 VDC, 900 MHz Application Circuit)



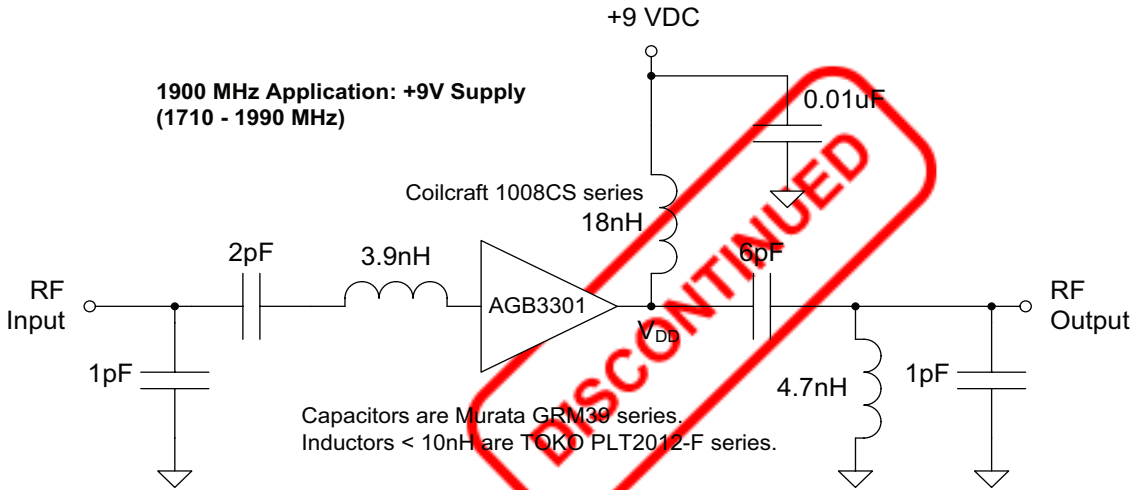

Figure 17: 1900 MHz Application Circuit (50Ω Terminations)

Table 7: 1900 MHz Application Performance (V_{SUPPLY} = +9 VDC)

PARAMETER	TYP	UNIT
Gain: S ₂₁	12.1	dB
Input Return Loss: S ₁₁	-10	dB
Output Return Loss: S ₂₂	-12	dB
Output IP ₃ ⁽¹⁾	45	dBm
Noise Figure	2.9	dB
Output 1dB Compression: P1dB	+21	dBm

Note:

(1) OIP₃ is measured with two tones: 1900 MHz and 1901 MHz, +5dBm output per tone.

Figure 18: Output 3rd-Order Intercept vs. Power (V_{SUPPLY} = +9 VDC, 1900 MHz Application Circuit)

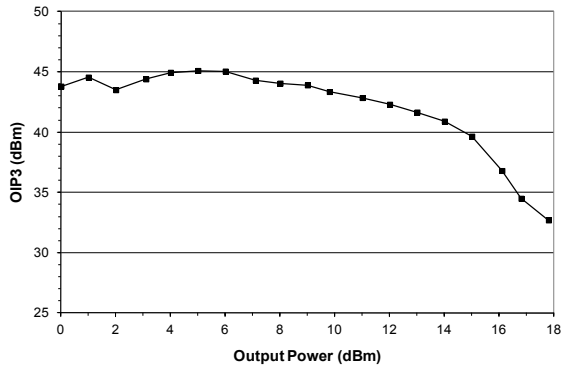

Figure 19: Gain vs. Frequency (V_{SUPPLY} = +9 VDC, 1900 MHz Application Circuit)

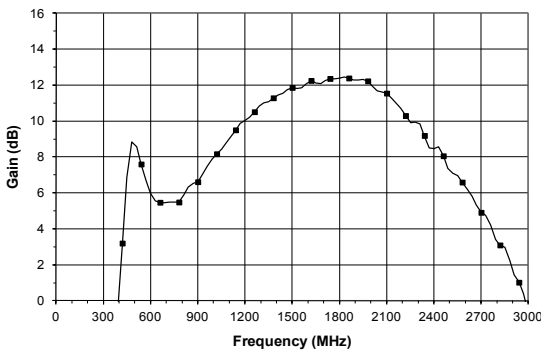
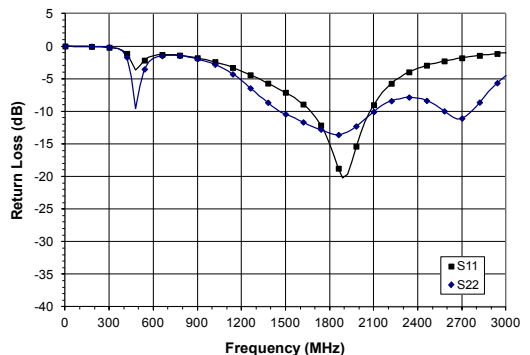

Figure 20: Return Loss vs. Frequency (V_{SUPPLY} = +9 VDC, 1900 MHz Application Circuit)



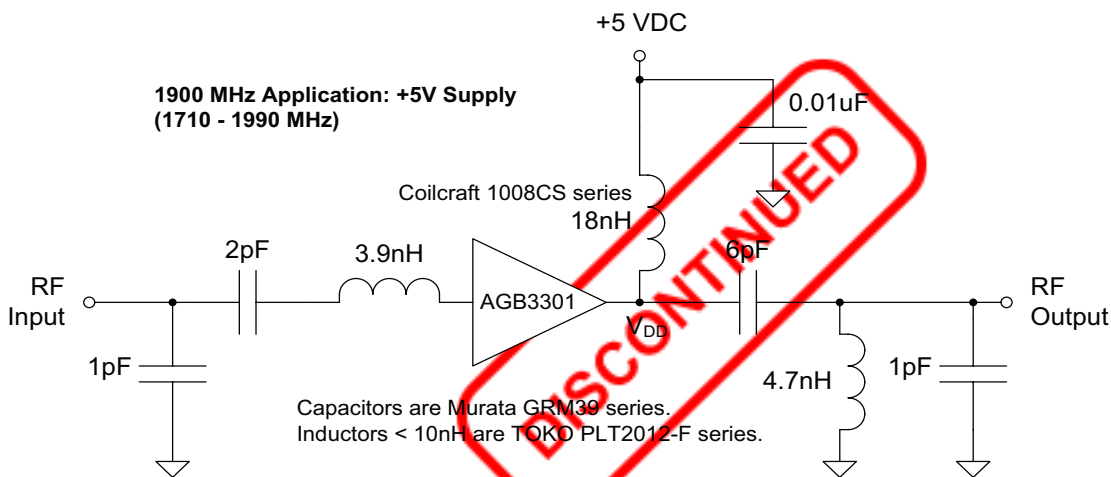

Figure 21: 1900 MHz Application Circuit (50Ω Terminations)

Table 8: 1900 MHz Application Performance (V_{SUPPLY} = +5 VDC)

PARAMETER	TYP	UNIT
Gain: S ₂₁	12.0	dB
Input Return Loss: S ₁₁	-10	dB
Output Return Loss: S ₂₂	-15	dB
Output IP ₃ ⁽¹⁾	+37	dBm
Noise Figure	2.8	dB
Output 1dB Compression: P1dB	+18	dBm

Note:

(1) OIP3 is measured with two tones: 1900 MHz and 1901 MHz, +5dBm output per tone.

Figure 22: Output 3rd-Order Intercept vs. Power (V_{SUPPLY} = +5 VDC, 1900 MHz Application Circuit)

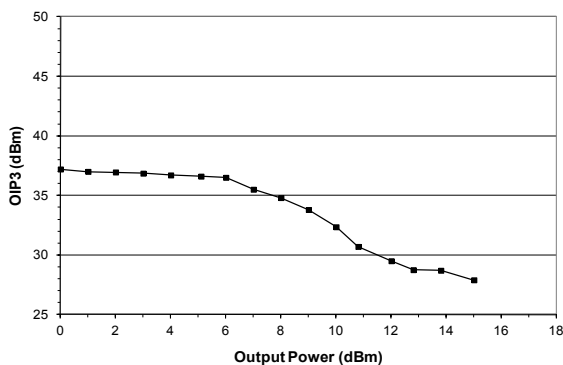

Figure 23: Gain vs. Frequency (V_{SUPPLY} = +5 VDC, 1900 MHz Application Circuit)

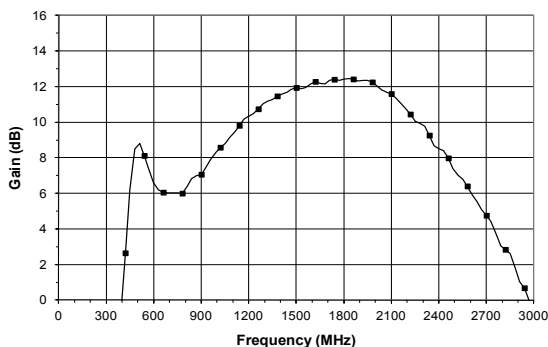
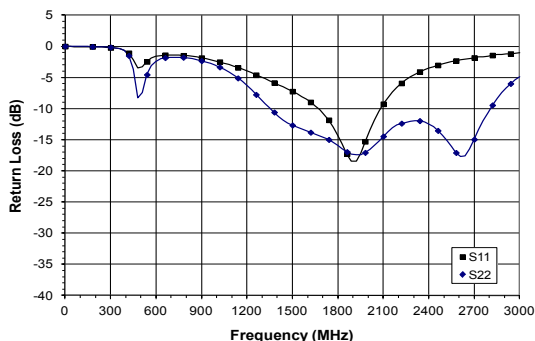

Figure 24: Return Loss vs. Frequency (V_{SUPPLY} = +5 VDC, 1900 MHz Application Circuit)



1900 - 2100 MHz: +9 VDC Supply

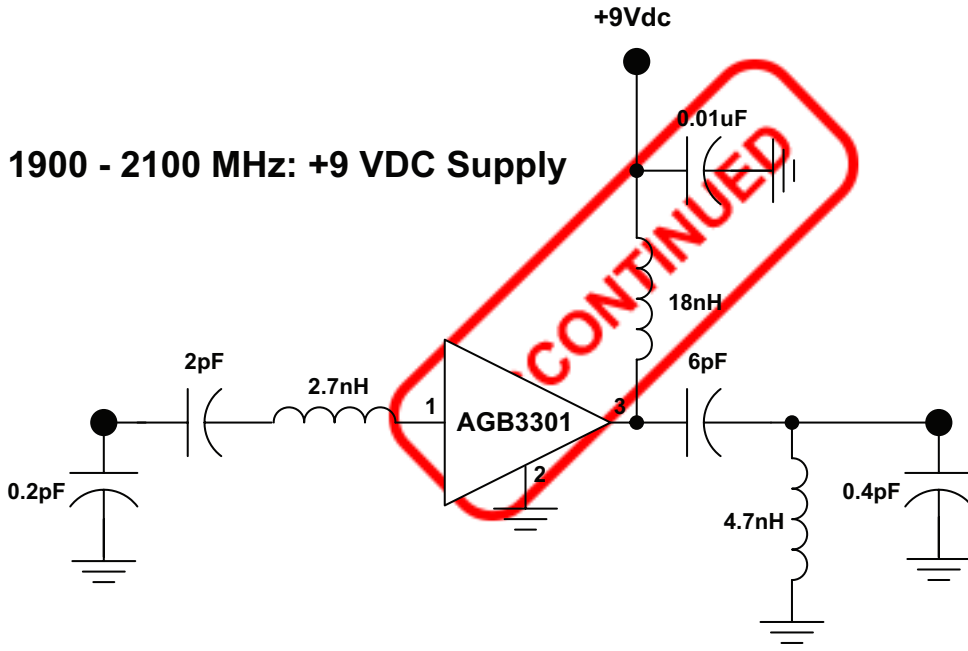

Figure 25: 1900 - 2100 MHz Application Circuit (50Ω Terminations)

Figure 26: Gain vs. Frequency
(V_{SUPPLY} = +9 VDC, 2100 MHz Application Circuit)

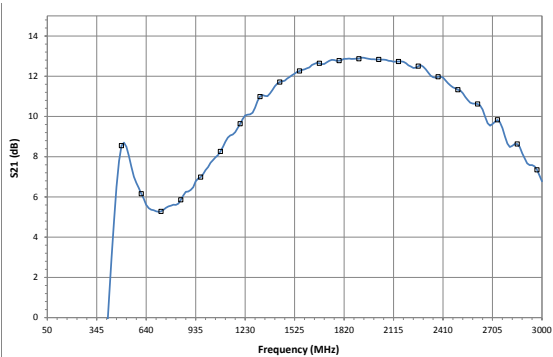
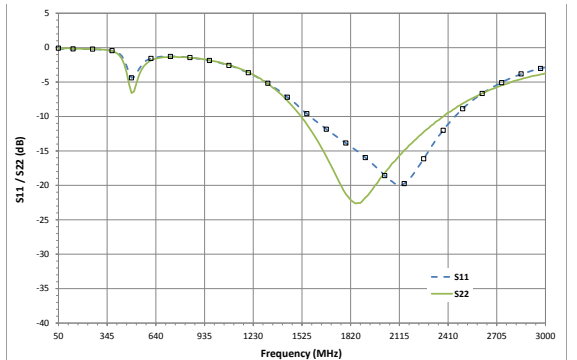

Figure 27: Return Loss vs. Frequency
(V_{SUPPLY} = +9 VDC, 2100 MHz Application Circuit)



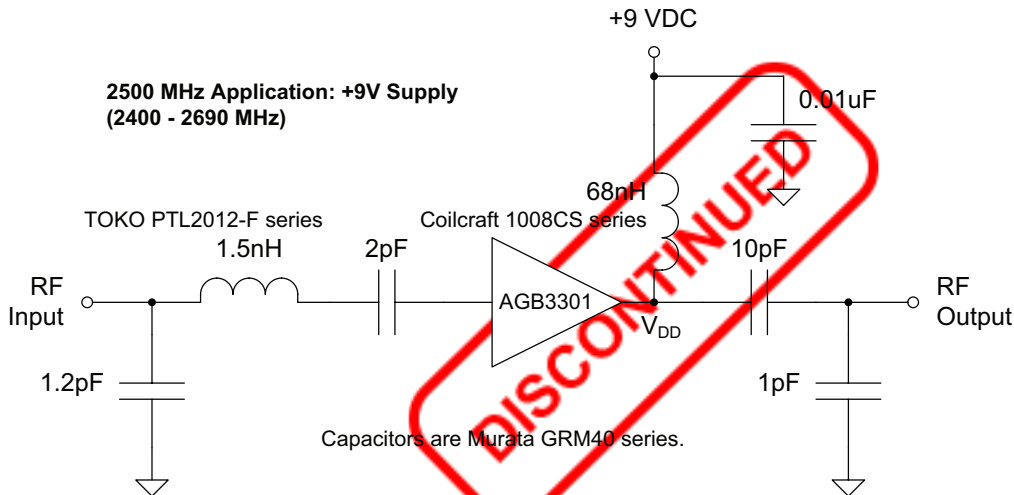

Figure 28: 2500 MHz Application Circuit (50Ω Terminations)

Table 9: 2500 MHz Application Performance (V_{SUPPLY} = +9 VDC)

PARAMETER	TYP	UNIT
Gain: S ₂₁	11.5	dB
Input Return Loss: S ₁₁	-15	dB
Output Return Loss: S ₂₂	-11	dB
Output IP ₃ ⁽¹⁾	+45	dBm
Noise Figure	3.4	dB
Output 1dB Compression: P1dB	+19	dBm

Note:

(1) OIP₃ is measured with two tones: 2500 MHz and 2501 MHz, +5dBm output per tone.

Figure 29: Output 3rd-Order Intercept vs. Power (V_{SUPPLY} = +9 VDC, 2500 MHz Application Circuit)

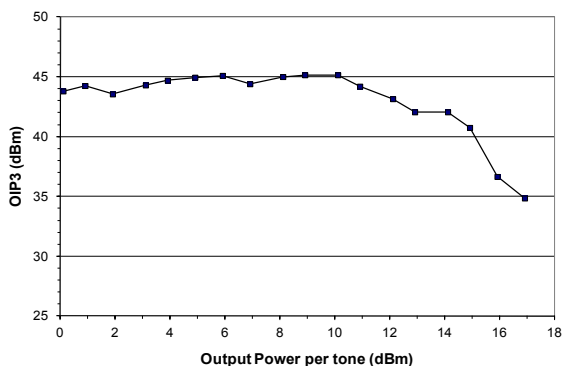

Figure 30: Gain vs. Frequency (V_{SUPPLY} = +9 VDC, 2500 MHz Application Circuit)

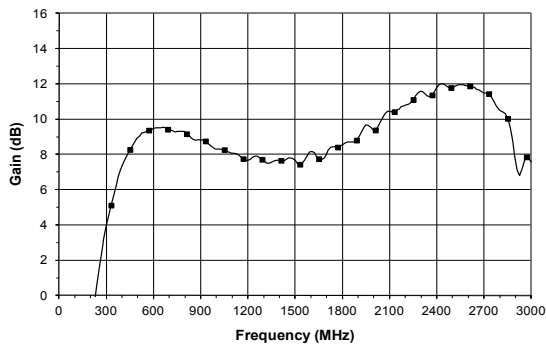
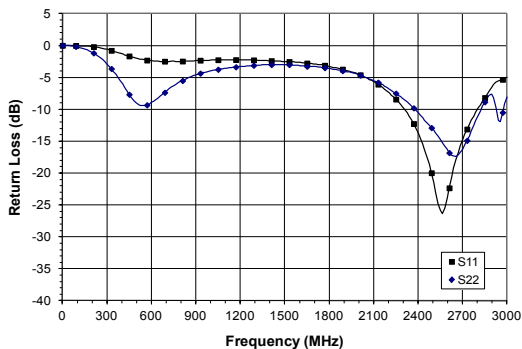

Figure 31: Return Loss vs. Frequency (V_{SUPPLY} = +9 VDC, 2500 MHz Application Circuit)



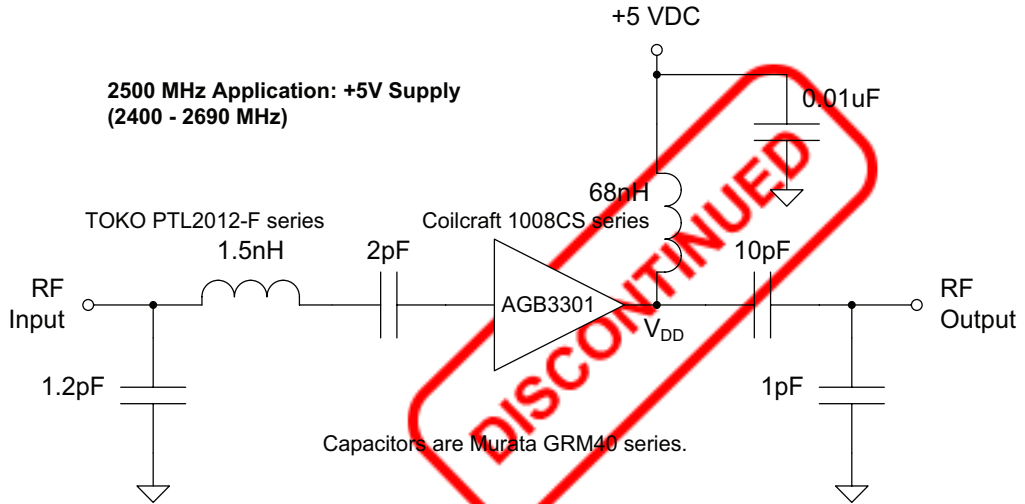

Figure 32: 2500 MHz Application Circuit (50Ω Terminations)

Table 10: 2500 MHz Application Performance (V_{SUPPLY} = +5 VDC)

PARAMETER	TYP	UNIT
Gain: S ₂₁	11.5	dB
Input Return Loss: S ₁₁	-15	dB
Output Return Loss: S ₂₂	-15	dB
Output IP ₃ ⁽¹⁾	+42	dBm
Noise Figure	3.3	dB
Output 1dB Compression: P _{1dB}	+17	dBm

Note:

(1) OIP₃ is measured with two tones: 2500 MHz and 2501 MHz, +5dBm output per tone.

Figure 33: Output 3rd-Order Intercept vs. Power (V_{SUPPLY} = +5 VDC, 2500 MHz Application Circuit)

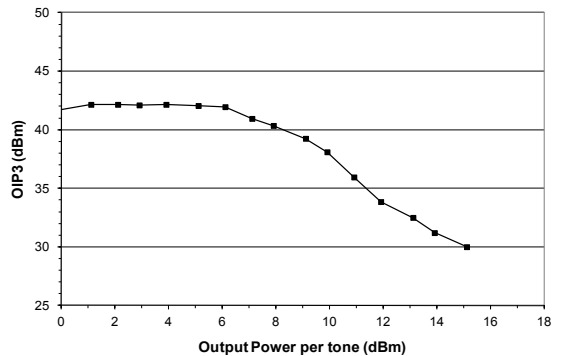

Figure 34: Gain vs. Frequency

(V_{SUPPLY} = +5 VDC, 2500 MHz Application Circuit)

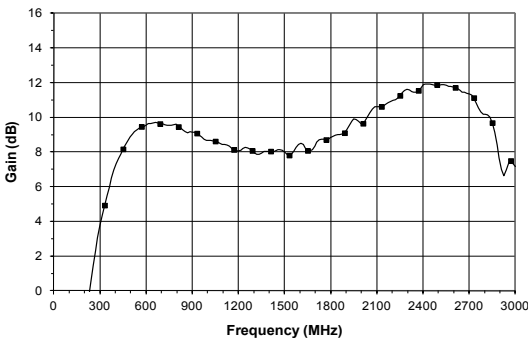
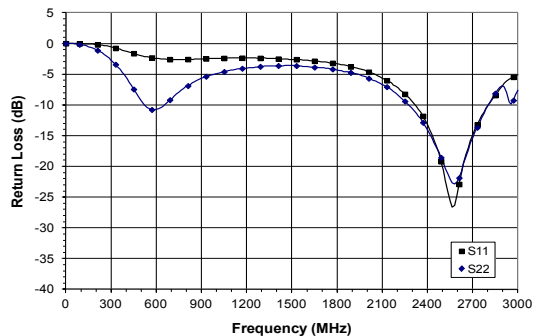

Figure 35: Return Loss vs. Frequency

(V_{SUPPLY} = +5 VDC, 2500 MHz Application Circuit)



Bias Circuit

A schematic of the basic, unmatched bias circuit for the AGB Series Gain Blocks is shown in Figure 33. The RF input and output terminations are 50Ω . Inductor L1 provides DC power from V_{SUPPLY} and serves as an RF choke to maintain desired AC performance. The input capacitor C1 and output capacitor C2 are RF blocks that isolate DC current from adjacent circuits. Capacitor C3 is used as an RF bypass that minimizes noise from the supply.

In some applications, a feedback resistor R1 may be added in series with L1, as shown in Figure 34, for improved stability or to serve as a voltage drop for operation from higher supply voltages.

Matching for RF Performance

The AGB3301 Gain Block amplifier can be used in many fixed wireless frequency bands, such as the 824-894 MHz U.S. cellular bands, the 1850-1990 MHz PCS band, the 880-960 MHz GSM band, the 2400-2500 MHz ISM band, and the 2500-2686 MHz MMDS band. Reactive matching circuits may be designed for

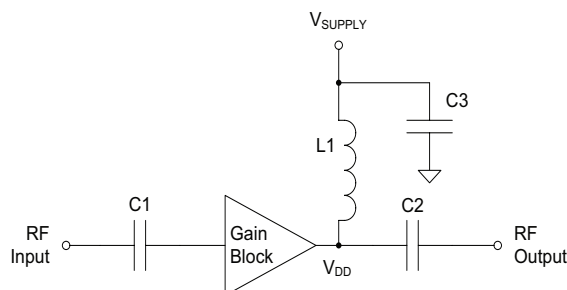

Figure 36: Unmatched Bias Circuit

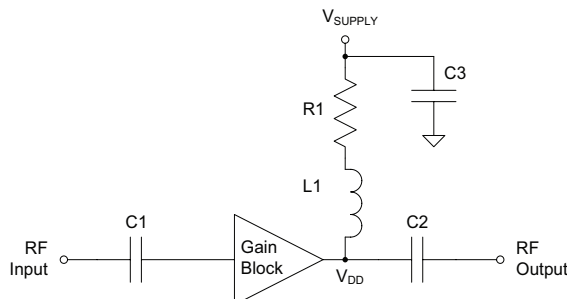

Figure 37: Bias Circuit with Optional Feedback/Voltage Drop Resistor

both the input and output, in order to optimize the RF performance for a particular application. For example, gain, linearity (OIP3) and return loss may be improved over a particular frequency band of interest.

Recommended matching circuits for various applications, as well as wideband S-parameters to use in the simulation of custom designs, are included in this data sheet. For a particular application not addressed in the data sheet, please consult with a company Sales Representative or Application Engineer.

Evaluation Boards

A versatile evaluation board that enables users to measure actual device performance has been developed for the AGB Series Gain Blocks. The generic layout allows the user to implement a wide variety of matching circuits, in order to assess performance for a particular application.

The evaluation board is 1.0" square, and is fabricated on 0.031" thick FR-4 material. Figures 35 and 36 show the via hole locations and the layout pattern on both sides of the evaluation board. The vias have a 0.010" diameter and are plated through.

To request an evaluation board, please contact a company Sales Representative or Application Engineer.

ESD Sensitivity

Electrostatic discharges can cause permanent damage to this device. Electrostatic discharges accumulate on test equipment and the human body, and can discharge without detection. Although the AGB3301 has some internal ESD protection, proper precautions and handling are strongly recommended. Refer to the application note on ESD precautions.

S-Parameter Data

Table 11 depicts the raw Magnitude and Angle data for an unmatched AGB3301 over the 50 to 3000 MHz frequency range of operation. Data is shown in 100 MHz steps, with a characteristic impedance of 50 Ohms, $V_{DD} = +9\text{ V}$, and at $T_A = +25\text{ }^\circ\text{C}$.

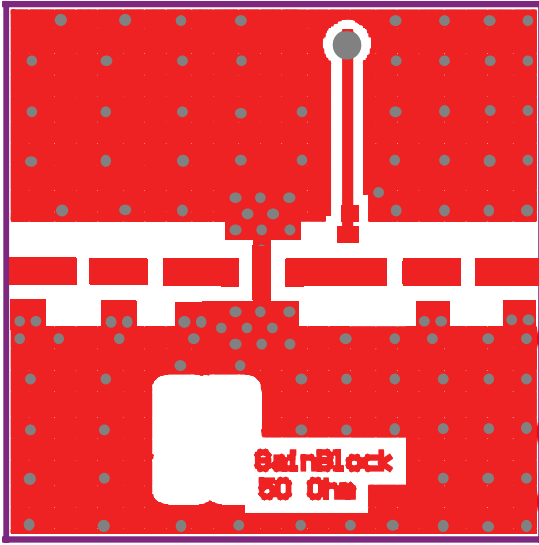

Figure 38: Evaluation Board - Front
(not to scale)

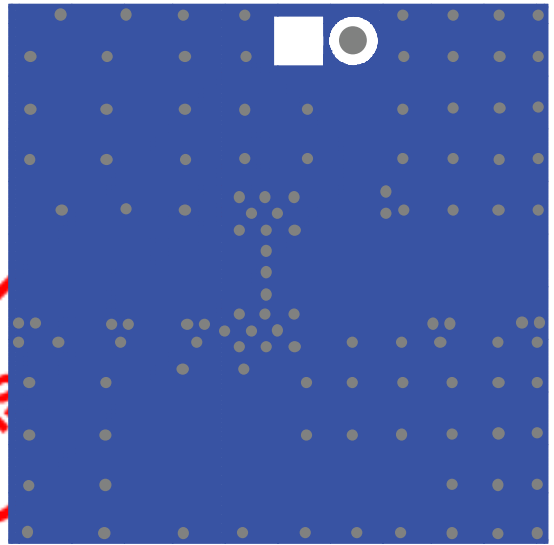
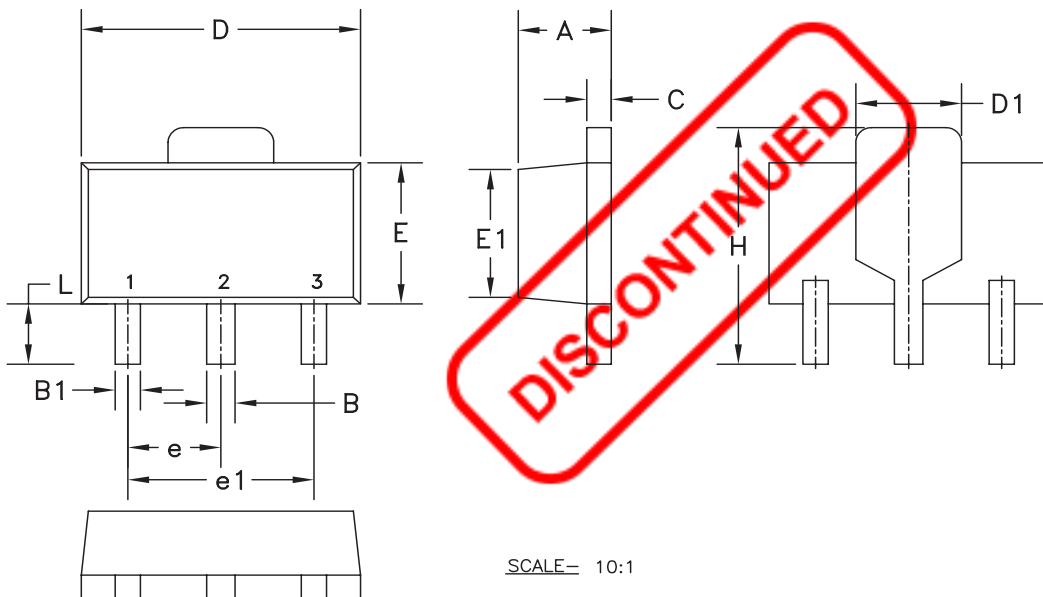

Figure 39: Evaluation Board - Back (X-ray)
(not to scale)

Table 11: AGB3301 S-Parameters in Unmatched 50 Ohm Test Fixture
 (T_A = +25 °C, V_{DD} = +9 VDC)

FREQ (MHz)	S11 (dB MAG)	S11 (ANG)	S21 (dB MAG)	S21 (ANG)	S12 (dB MAG)	S12 (ANG)	S22 (dB MAG)	S22 (ANG)	K Factor
50	-17.240	-26.836	13.890	177.501	-17.739	-5.826	-22.828	-12.593	1.071
100	-17.818	-24.935	13.923	166.419	-17.740	-12.179	-22.325	-9.197	1.071
200	-17.974	-34.201	13.867	152.851	-17.761	-22.231	-21.803	-8.616	1.074
300	-17.597	-48.060	13.823	137.564	-17.829	-34.138	-20.469	-13.300	1.075
400	-16.818	-61.919	13.738	122.524	-17.880	-46.032	-19.340	-22.688	1.074
500	-16.203	-72.241	13.689	109.623	-17.981	-56.240	-18.198	-32.842	1.074
600	-15.872	-86.658	13.618	94.800	-18.068	-68.243	-17.305	-42.732	1.075
700	-15.078	-99.811	13.505	80.160	-18.252	-79.835	-15.953	-55.898	1.077
800	-14.502	-111.363	13.431	67.244	-18.380	-90.550	-14.951	-66.502	1.074
900	-13.558	-123.957	13.324	52.393	-18.552	-102.255	-13.797	-79.947	1.067
1000	-12.872	-136.927	13.155	37.799	-18.793	-114.050	-13.045	-94.039	1.073
1100	-12.164	-147.021	13.041	25.076	-18.992	-124.586	-12.202	-106.633	1.067
1200	-11.546	-159.463	12.828	10.497	-19.285	-136.011	-11.418	-120.336	1.074
1300	-10.784	-170.927	12.712	-4.332	-19.621	-148.937	-10.467	-134.472	1.063
1400	-10.459	178.426	12.567	-16.845	-19.828	-158.967	-9.884	-144.828	1.063
1500	-9.687	166.125	12.363	-31.761	-20.305	-171.081	-9.063	-158.869	1.060
1600	-9.113	154.614	12.297	-46.270	-20.620	175.644	-8.547	-172.334	1.045
1700	-8.542	144.746	11.990	-57.669	-20.966	166.403	-7.995	175.205	1.046
1800	-8.130	132.897	11.806	-72.889	-21.605	153.682	-7.426	162.038	1.066
1900	-7.614	121.269	11.563	-86.545	-22.073	141.197	-6.857	148.241	1.061
2000	-7.248	111.723	11.180	-100.060	-22.884	131.005	-6.447	136.894	1.131
2100	-6.829	99.551	11.067	-114.887	-23.345	116.441	-6.000	123.076	1.113
2200	-6.460	88.236	10.692	-128.636	-24.074	105.279	-5.583	110.380	1.164
2300	-6.101	78.176	10.611	-142.376	-24.869	93.413	-5.240	98.427	1.191
2400	-5.808	67.626	10.326	-153.887	-25.528	82.036	-4.884	85.867	1.228
2500	-5.462	56.234	9.626	-167.744	-27.027	68.885	-4.507	72.338	1.463
2600	-5.221	46.556	9.472	179.161	-27.961	56.842	-4.273	61.953	1.564
2700	-5.002	35.297	8.791	166.470	-29.593	45.457	-4.003	49.279	1.949
2800	-4.731	25.044	8.367	151.095	-31.373	26.771	-3.738	36.788	2.365
2900	-4.499	15.361	8.378	140.912	-32.317	14.056	-3.573	25.880	2.484
3000	-4.268	5.171	8.018	126.890	-34.888	-1.921	-3.327	13.676	3.298

PACKAGE OUTLINE



SYM _{BOL}	INCHES	
	MIN.	MAX.
A	0.055	0.063
B	0.017	0.022
B1	0.014	0.019
C	0.014	0.017
D	0.173	0.181
D1	0.066	0.070
E	0.090	0.099
E1	0.084	0.086
e	0.059	BSC
e1	0.118	BSC
H	0.155	0.167
L	0.029	0.041

NOTES:

1. CONTROLLING DIMENSIONS: INCHES.
2. TOP PACKAGE ANGLE IS 9° ±1°/-2° TOLERANCE. PACKAGE ANGLE IS 3° MAX.
3. PACKAGE CORNER RADIUS IS 5 MILS MAX ON ALL CORNERS.
4. SHINNY PACKAGE FINISH ON ALL SIDES EXCEPT TOP SIDE. FINISH MINIMUM MATTE OF 10-14VDI.

Figure 40: S24 Package Outline - SOT-89

TOP BRAND



NOTES:

1. PART NUMBER: FOUR NUMERIC CHARACTERS
2. WAFER LOT NUMBER: LLLL=FOUR NUMERIC CHARACTERS
NN= TWO ALPHABETIC CHARACTERS
3. TYPE : ELITE
SIZE : 2-POINT
COLOR : LASER

Figure 41: Branding Specifications

ORDERING INFORMATION

PART NUMBER	TEMPERATURE RANGE	PACKAGE DESCRIPTION	COMPONENT PACKAGING
AGB3301RS24Q1	-40 to +100 °C	RoHS Compliant SOT-89 Package	1,000 piece Tape and Reel

DISCONTINUED



Copyright © 2016 Skyworks Solutions, Inc. All Rights Reserved.

Information in this document is provided in connection with Skyworks Solutions, Inc. ("Skyworks") products or services. These materials, including the information contained herein, are provided by Skyworks as a service to its customers and may be used for informational purposes only by the customer. Skyworks assumes no responsibility for errors or omissions in these materials or the information contained herein. Skyworks may change its documentation, products, services, specifications or product descriptions at any time, without notice. Skyworks makes no commitment to update the materials or information and shall have no responsibility whatsoever for conflicts, incompatibilities, or other difficulties arising from any future changes.

No license, whether express, implied, by estoppel or otherwise, is granted to any intellectual property rights by this document. Skyworks assumes no liability for any materials, products or information provided hereunder, including the sale, distribution, reproduction or use of Skyworks products, information or materials, except as may be provided in Skyworks Terms and Conditions of Sale.

THE MATERIALS, PRODUCTS AND INFORMATION ARE PROVIDED "AS IS" WITHOUT WARRANTY OF ANY KIND, WHETHER EXPRESS, IMPLIED, STATUTORY, OR OTHERWISE, INCLUDING FITNESS FOR A PARTICULAR PURPOSE OR USE, MERCHANTABILITY, PERFORMANCE, QUALITY OR NON-INFRINGEMENT OF ANY INTELLECTUAL PROPERTY RIGHT; ALL SUCH WARRANTIES ARE HEREBY EXPRESSLY DISCLAIMED. SKYWORKS DOES NOT WARRANT THE ACCURACY OR COMPLETENESS OF THE INFORMATION, TEXT, GRAPHICS OR OTHER ITEMS CONTAINED WITHIN THESE MATERIALS. SKYWORKS SHALL NOT BE LIABLE FOR ANY DAMAGES, INCLUDING BUT NOT LIMITED TO ANY SPECIAL, INDIRECT, INCIDENTAL, STATUTORY, OR CONSEQUENTIAL DAMAGES, INCLUDING WITHOUT LIMITATION, LOST REVENUES OR LOST PROFITS THAT MAY RESULT FROM THE USE OF THE MATERIALS OR INFORMATION, WHETHER OR NOT THE RECIPIENT OF MATERIALS HAS BEEN ADVISED OF THE POSSIBILITY OF SUCH DAMAGE.

Skyworks products are not intended for use in medical, lifesaving or life-sustaining applications, or other equipment in which the failure of the Skyworks products could lead to personal injury, death, physical or environmental damage. Skyworks customers using or selling Skyworks products for use in such applications do so at their own risk and agree to fully indemnify Skyworks for any damages resulting from such improper use or sale.

Customers are responsible for their products and applications using Skyworks products, which may deviate from published specifications as a result of design defects, errors, or operation of products outside of published parameters or design specifications.

Customers should include design and operating safeguards to minimize these and other risks. Skyworks assumes no liability for applications assistance, customer product design, or damage to any equipment resulting from the use of Skyworks products outside of stated published specifications or parameters.

Skyworks and the Skyworks symbol are trademarks or registered trademarks of Skyworks Solutions, Inc., in the United States and other countries. Third-party brands and names are for identification purposes only, and are the property of their respective owners. Additional information, including relevant terms and conditions, posted at www.skyworksinc.com, are incorporated by reference.

Skyworks Solutions, Inc.

Phone [781] 376-3000 • Fax [781] 376-3100 • sales@skyworksinc.com • www.skyworksinc.com

Skyworks Proprietary and Confidential information • Products and Product Information are Subject to Change Without Notice