



**SPECIFICATION
FOR
LCD MODULE**

**MODULE NO: AFY320240B0-3.5N12NTM-R
REVISION NO: A**

Customer's Approval:

--

	SIGNATURE	DATE
PREPARED BY (RD ENGINEER)		
CHECKED BY		
APPROVED BY		

REVISION RECORD

REV NO.	REV DATE	CONTENTS	REMARKS
O	2015-12-24	First release	Preliminary
A	2016-02-16	Update the TBD data	Page4,6

CONTENTS

1. GENERAL INFORMATION	4
2.ABSOLUTE MAXIMUM RATINGS	4
3. ELECTRICAL CHARACTERISTICS.....	4
4. BACKLIGHT CHARACTERISTICS	4
5. EXTERNAL DIMENSIONS.....	5
6. ELECTRO-OPTICAL CHARACTERISTICS	6
7. INTERFACE DESCRIPTION.....	8
8. AC CHARACTERISTICS	9
9.POWER SEQUENCE.....	11
10. RELIABILITY TEST CONDITIONS.....	13
11. INSPECTION CRITERION	14
12. HANDLING PRECAUTIONS.....	17
13. PRECAUTION FOR USE	18
14. PACKING SPECIFICATION.....	18

1. GENERAL INFORMATION

No.	Item	Contents	Unit
1	LCD size	3.5 inch (Diagonal)	/
2	LCD type	TN/Normally white/Transmissive(Anti-glare)	/
3	Viewing direction(eye)	12 O'clock	/
4	Gray scale inversion direction	6 O'clock	/
5	Resolution(H*V)	320 *240 Pixels	/
6	Module size (L*W*H)	76.9*63.9*4.4	mm
7	Active area (L*W)	70.08*52.56	mm
8	Pixel pitch (L*W)	0.219*0.219	mm
9	Interface type	RGB interface	/
10	Module power consumption	0.066(without backlight)	W
11	Back light type	LED	/
12	Driver IC	HX8238D OR COMPATIBLE	/
13	Weight	42	g

2.ABSOLUTE MAXIMUM RATINGS

Item	Symbol	Min	Max	Unit
Power supply input voltage (LCM)	VDD	-0.3	3.6	V
Backlight current (normal temp.)	I _{LED}	-	50	mA
Operation temperature	Top	-20	70	°C
Storage temperature	T _{st}	-30	80	°C
Humidity	RH	-	90%(Max60 °C)	RH

3. ELECTRICAL CHARACTERISTICS

DC CHARACTERISTICS (at Ta=25°C)

Item	Symbol	Min	Typ	Max	Unit	Note
Power supply input voltage (LCM)	VDD	2.5	3.3	-	V	
I/O logic voltage	VDDIO	N/A	N/A	N/A	V	
Input voltage 'H' level	V _{IH}	0.7VDD	-	VDD	V	
Input voltage 'L' level	V _{IL}	VSS	-	0.3VDD	V	
Power supply current	I _{VDD}	-	20	-	mA	
TFT gate on voltage	V _{GH}	-	N/A	-	V	
TFT gate off voltage	V _{GL}	-	N/A	-	V	
Analog power supply voltage	AVDD	-	N/A	-	V	
Differential input common mode voltage	V _{com}	-	N/A	-	V	

4. BACKLIGHT CHARACTERISTICS

(at Ta=25°C,RH=60%)

Item	Symbol	Min.	Typ.	Max.	Unit	Note
LED forward voltage	V _F	-	9.6	10.2	V	IF=20*2mA
LED forward current	I _F	-	40	-	mA	
LED power consumption	P _{LED}	-	0.384	-	W	Note1
Number of LED	-		6		PCS	
Connection mode	-	3 in series	2 in parallel		/	
LED life-time	-	20000	-	-	Hrs	Note2

Note1.Calculator Value for reference: IF*VF = PLED

Note2.The LED Life-time define as the estimated time to 50% degradation of initial brightness at Ta=25°C and IF =40mA. The LED lifetime could be decreased if operating IF is larger than 40mA

5. EXTERNAL DIMENSIONS

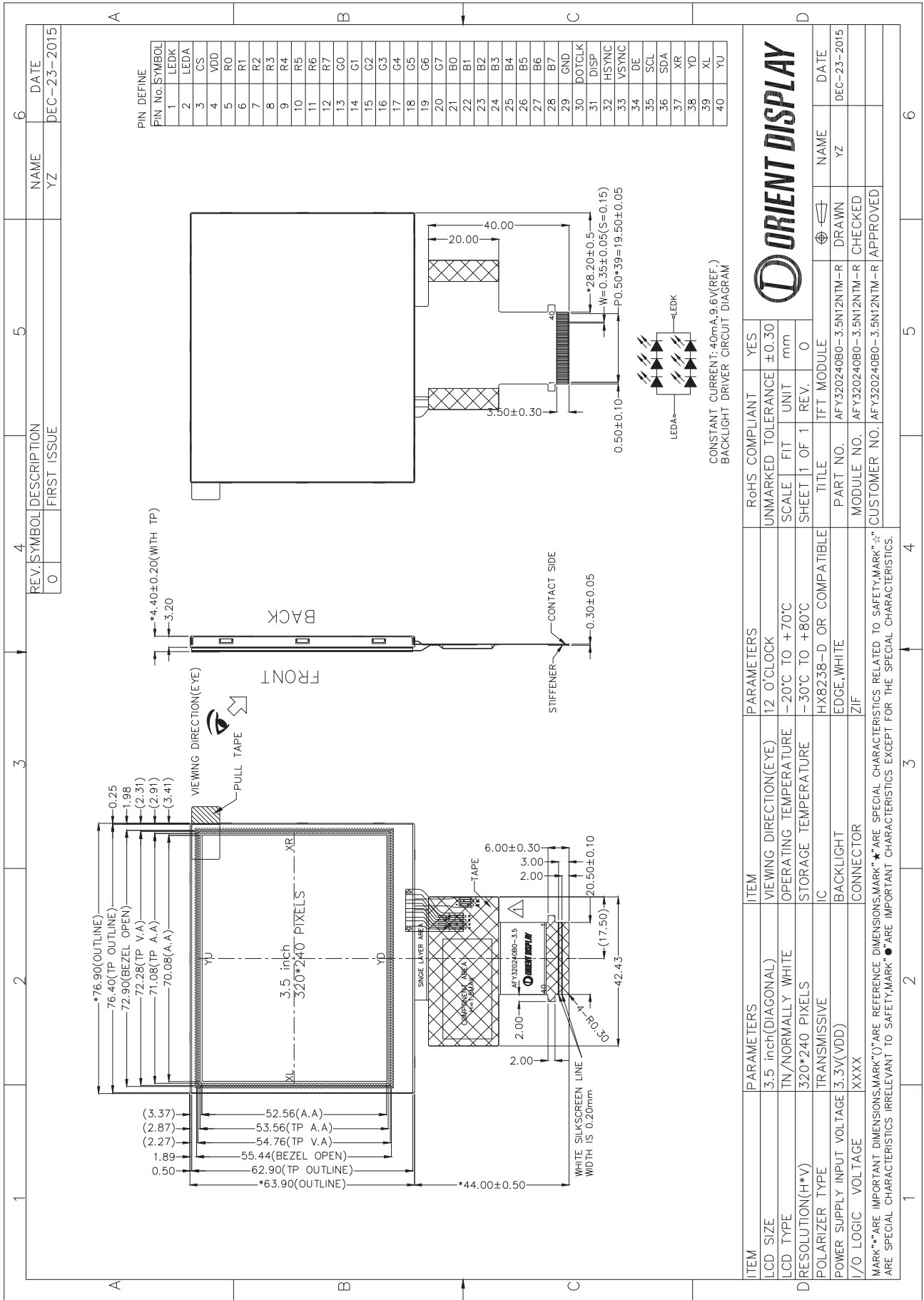

6. ELECTRO-OPTICAL CHARACTERISTICS

Item	Symbol	Condition	Min	Typ	Max	Unit	Remark	Note
Response time	Tr+ Tf	-	-	50	80	ms	FIG 1.	Note 4
Contrast ratio	Cr		200	300	-	-	FIG 2.	Note 1
Surface luminance	Lv	$\theta=0^\circ$	350	440	-	cd/m ²	FIG 2.	Note 2
Luminance uniformity	Yu	$\theta=0^\circ$	75	80	-	%	FIG 2.	Note 3
NTSC	-	$\theta=0^\circ$	-	60	-	%	FIG 2.	Note 5
Viewing angle	θ	$\varnothing = 90^\circ$	50	60	-	deg	FIG 3.	Note 6
		$\varnothing = 270^\circ$	40	50	-	deg	FIG 3.	
		$\varnothing = 0^\circ$	50	60	-	deg	FIG 3.	
		$\varnothing = 180^\circ$	50	60	-	deg	FIG 3.	
CIE (x, y) chromaticity	Red x	$\theta=0^\circ$ $\varnothing=0^\circ$ Ta=25°C	0.5706	0.6106	0.6506	-	FIG 2. CIE1931	Note 5
	Red y		0.3254	0.3654	0.4054	-		
	Green x		0.3000	0.3400	0.3800	-		
	Green y		0.5649	0.6049	0.6449	-		
	Blue x		0.1074	0.1474	0.1874	-		
	Blue y		0.0387	0.0787	0.1187	-		
	White x		0.2632	0.3032	0.3432	-		
	White y		0.2829	0.3229	0.3629	-		

Note1.Definition of contrast ratio

Contrast Ratio(CR) is defined mathematically by the following formula. For more information see FIG.2

$$\text{Contrast Ratio} = \frac{\text{Luminance measured when LCD on the "White" state}}{\text{Luminance measured when LCD on the "Black" state}}$$

Note2.Definition of surface luminance

Surface luminance is the LCD surface from the surface with all pixels displaying white. For more information see FIG.2

Lv = Average Surface Luminance with all white pixels (P1, P2, P3Pn)

Note3.Definition of luminance uniformity

The luminance uniformity in surface luminance (Yu) is determined by measuring luminance at each test position 1 through n, and then dividing the maximum luminance of n points luminance by minimum luminance of n points luminance. For more information see FIG.2

$$Y_u = \frac{\text{Minimum Surface Luminance with all white pixels (P1, P2, P3Pn)}}{\text{Maximum Surface Luminance with all white pixels (P1, P2, P3Pn)}}$$

Note4. Definition of Response time

The response time is defined as the LCD optical switching time interval between "White" state and "Black" state. Rise time (TON) is the time between photo detector output intensity changed from 90% to 10%. And fall time (TOFF) is the time between photo detector output intensity changed from 10% to 90%.For additional information see FIG1.

Note5. Definition of color chromaticity (CIE1931)

CIE (x, y) chromaticity ,The x, y value is determined by screen active area center position P5,For more information see FIG.2

Note6. Definition of Viewing angle

Viewing angle is the angle at which the contrast ratio is greater than 10. The angles are determined for the horizontal or x axis and the vertical or y axis with respect to the z axis which is normal to the LCD surface. For more information see FIG.3

For Viewing angle and response time testing, the testing data is base on Autronic-Melchers's ConoScope or DMS series Instruments or compatible. For contrast ratio, Surface Luminance, Luminance uniformity and CIE, the testing data is base on TOPCON's BM-5or BM-7 photo detector or compatible.

Note: For TFT module, Gray scale reverse occurs in the direction of panel viewing angle.

FIG.1. The definition of Response Time

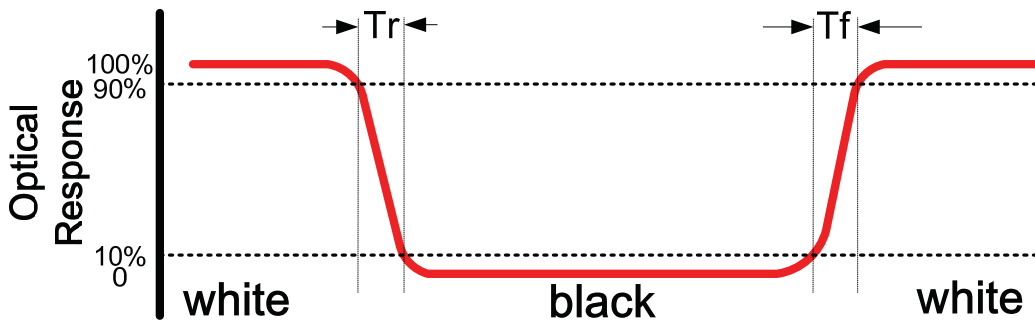

FIG.2. Measuring method for Contrast ratio, surface luminance, Luminance uniformity, CIE (x, y) chromaticity

Size: $S \leq 5"$ (see Figure a)

A : 5 mm B : 5 mm

H,V : Active Area

Light spot size $\varnothing=5\text{mm}$ (BM-5) or $\varnothing=7.7\text{mm}$ (BM-7) 50cm distance or compatible distance from the LCD surface to detector lens.

test spot position: see Figure a.

measurement instrument : TOPCON's luminance meter BM-5 or BM-7 or compatible (see Figure c)

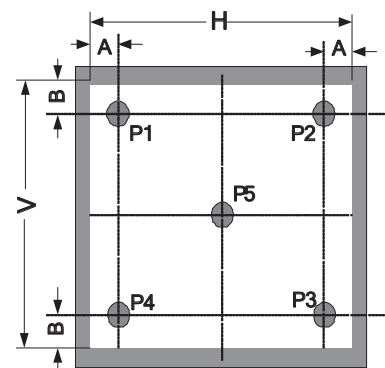

Figure a

Size: $5" < S \leq 12.3"$ (see Figure b)

H,V : Active Area

Light spot size $\varnothing=5\text{mm}$ (BM-5) or $\varnothing=7.7\text{mm}$ (BM-7) 50cm distance or compatible distance from the LCD surface to detector lens

test spot position: see Figure b

measurement instrument : TOPCON's luminance meter BM-5 or BM-7 or compatible (see Figure c)

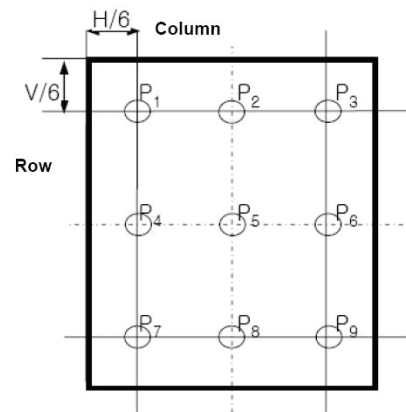

Figure b

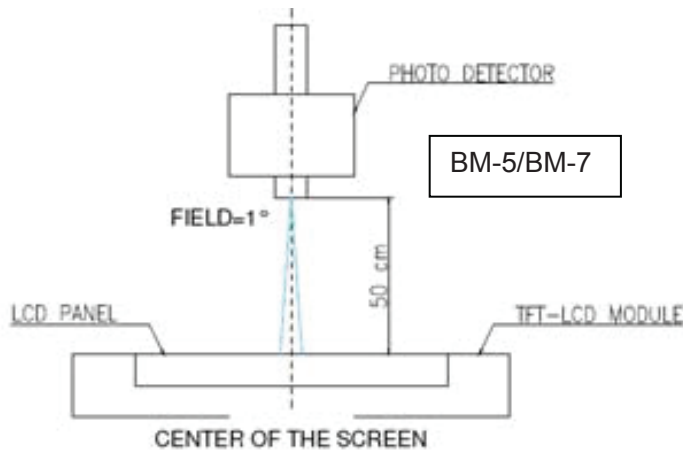
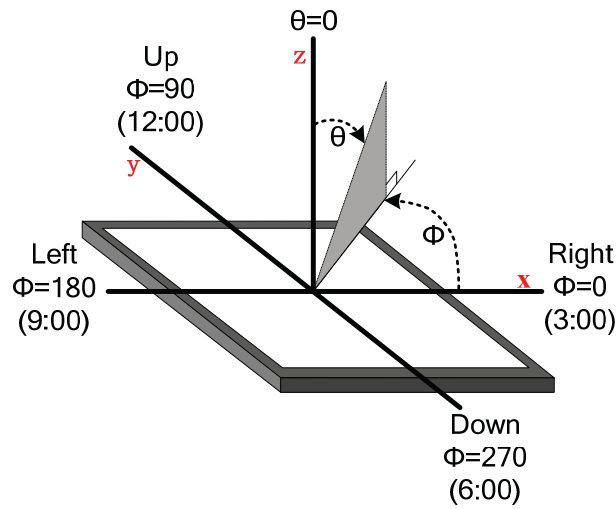

Figure c

FIG.3. The definition of viewing angle



7. INTERFACE DESCRIPTION

LCM Interface description

Interface No.	Name	I/O or connect to	Description
1	LEDK	P	Power for LED backlight(Cathode)
2	LEDA	P	Power for LED backlight(Anode)
3	CS	I	Chip select pin
4	VDD	P	Power for LCD
5-12	Red(0-7)	I	Red data
13-20	Green(0-7)	I	Green data
21-28	Blue(0-7)	I	Blue data
29	GND	I	Ground
30	DCLK	I	Dot-clock signal
31	DISP	I	Display on/off
32	HSYNC	I	Horizontal sync input.
33	VSYNC	I	Vertical sync input
34	DE	I	Data enable
35	SCL	I	Clock pin of serial interface
36	SDA	I/O	Data input pin in serial mode
37	XR	O	TP: X right
38	YD	O	TP: Y bottom
39	XL	O	TP: X left
40	YU	O	TP: Y top

8. AC CHARACTERISTICS

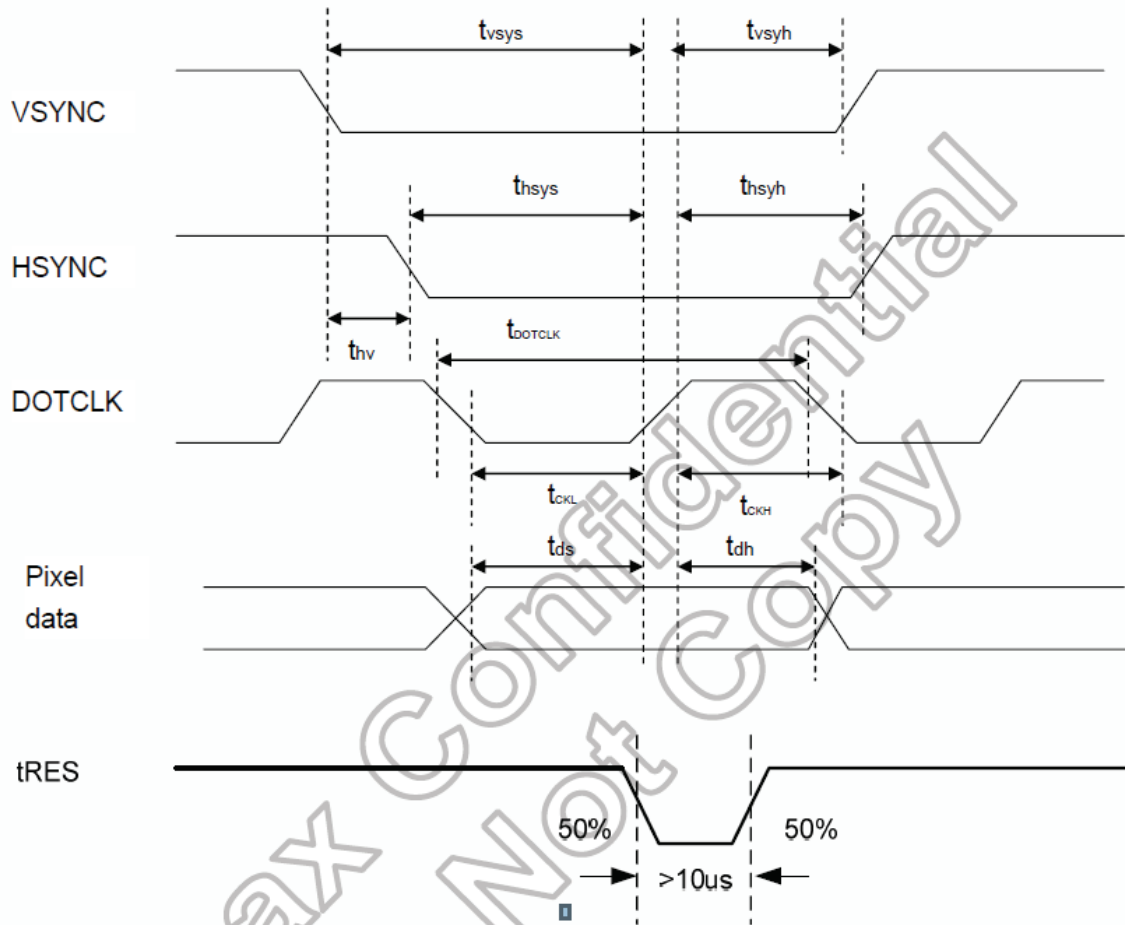
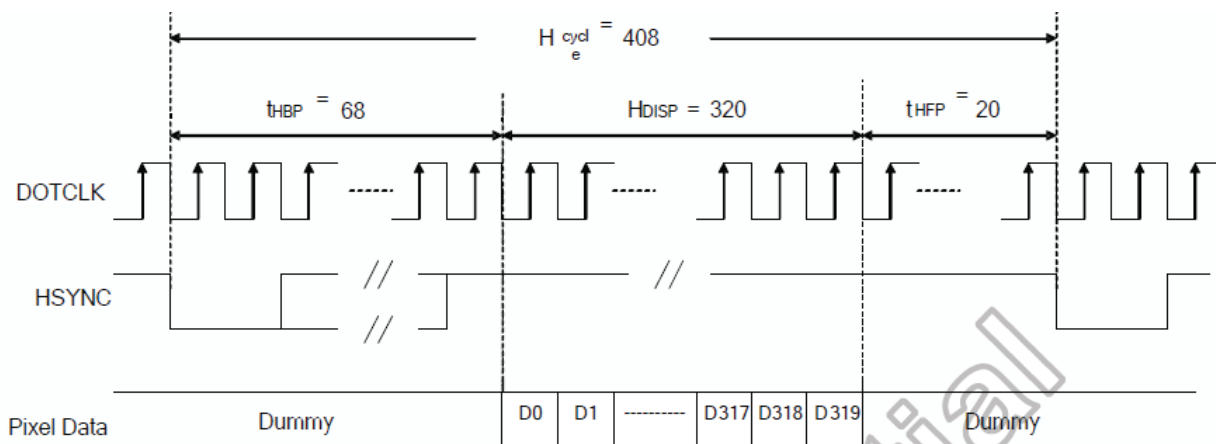

Figure 12. 1 Pixel Timing

Characteristics	Symbol	Min.		Typ.		Max.		Unit
		24 bit	8 bit	24 bit	8 bit	24 bit	8 bit	
DOTCLK Frequency	fDOTCLK	-	-	6.5	19.5	10	30	MHz
DOTCLK Period	tDOTCLK	100	33.3	154	51.3	-	-	ns
Vertical Sync Setup Time	tvsys	20	10	-	-	-	-	ns
Vertical Sync Hold Time	tvsyh	20	10	-	-	-	-	ns
Horizontal Sync Setup Time	thsys	20	10	-	-	-	-	ns
Horizontal Sync Hold Time	thsyh	20	10	-	-	-	-	ns
Phase difference of Sync Signal Falling Edge	thv	1		-		240		tDOTCLK
DOTCLK Low Period	tCKL	50	15	-	-	-	-	ns
DOTCLK High Period	tCKH	50	15	-	-	-	-	ns
Data Setup Time	tds	12	10	-	-	-	-	ns
Data hold Time	tdh	12	10	-	-	-	-	ns
Reset pulse width	tRES	10		-		-		μs

Note: External clock source must be provided to DOTCLK pin of HX8238-D. The driver will not operate if absent of the clocking signal.

Table 12. 1 Pixel Timing



(a) Horizontal Data Transaction Timing

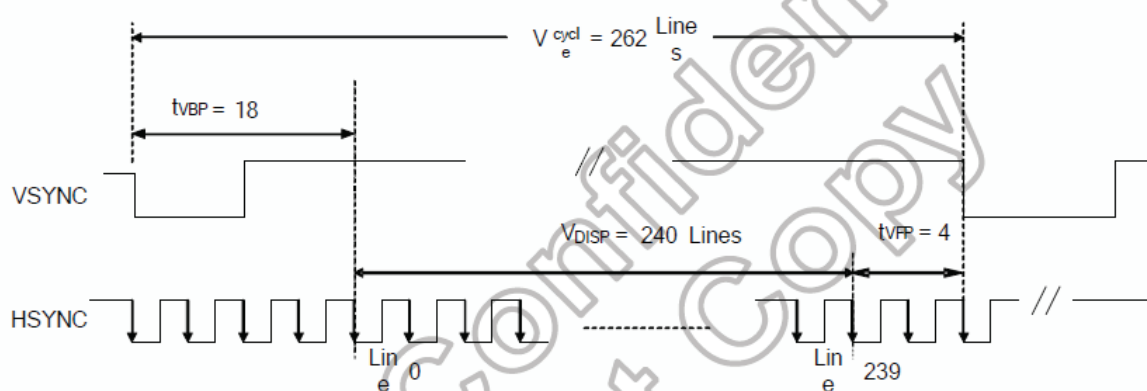

(b) Vertical Data Transaction Timing

Figure 12. 2 Data Transaction Timing in Parallel RGB (24 bit) Interface (SYNC Mode)

Characteristics	Symbol	Min.		Typ.		Max.		Unit
		24 bit	8 bit	24 bit	8 bit	24 bit	8 bit	
DOTCLK Frequency	f _{DOTCLK}	-	-	6.5	19.5	10	30	MHz
DOTCLK Period	t _{DOTCLK}	100	33.3	154	51.3	-	-	ns
Horizontal Frequency (Line)	f _H	-	-	14.9	-	22.35	-	KHz
Vertical Frequency (Refresh)	f _V	-	-	60	-	90	-	Hz
Horizontal Back Porch	t _{HBP}	-	-	68	204	-	-	t _{DOTCLK}
Horizontal Front Porch	t _{HFP}	-	-	20	60	-	-	t _{DOTCLK}
Horizontal Data Start Point	t _{HBP}	-	-	68	204	-	-	t _{DOTCLK}
Horizontal Blanking Period	t _{HBP} + t _{HFP}	-	-	88	264	-	-	t _{DOTCLK}
Horizontal Display Area	H _{DISP}	-	-	320	960	-	-	t _{DOTCLK}
Horizontal Cycle	H _{cycle}	-	-	408	1224	450	1350	t _{DOTCLK}
Vertical Back Porch	t _{VBP}	-	-	18	-	-	-	Lines
Vertical Front Porch	t _{VFP}	-	-	4	-	-	-	Lines
Vertical Data Start Point	t _{VBP}	-	-	18	-	-	-	Lines
Vertical Blanking Period	t _{VBP} + t _{VFP}	-	-	22	-	-	-	Lines
Vertical Display Area	NTSC	V _{DISP}	-	240		-	-	Lines
	PAL			280(PALM=0)				
	PAL			288(PALM=1)				
Vertical Cycle	NTSC	V _{cycle}	-	262		350	-	Lines
	PAL			313				

Table 12. 2 Data Transaction Timing in Normal Operating Mode

9. POWER SEQUENCE

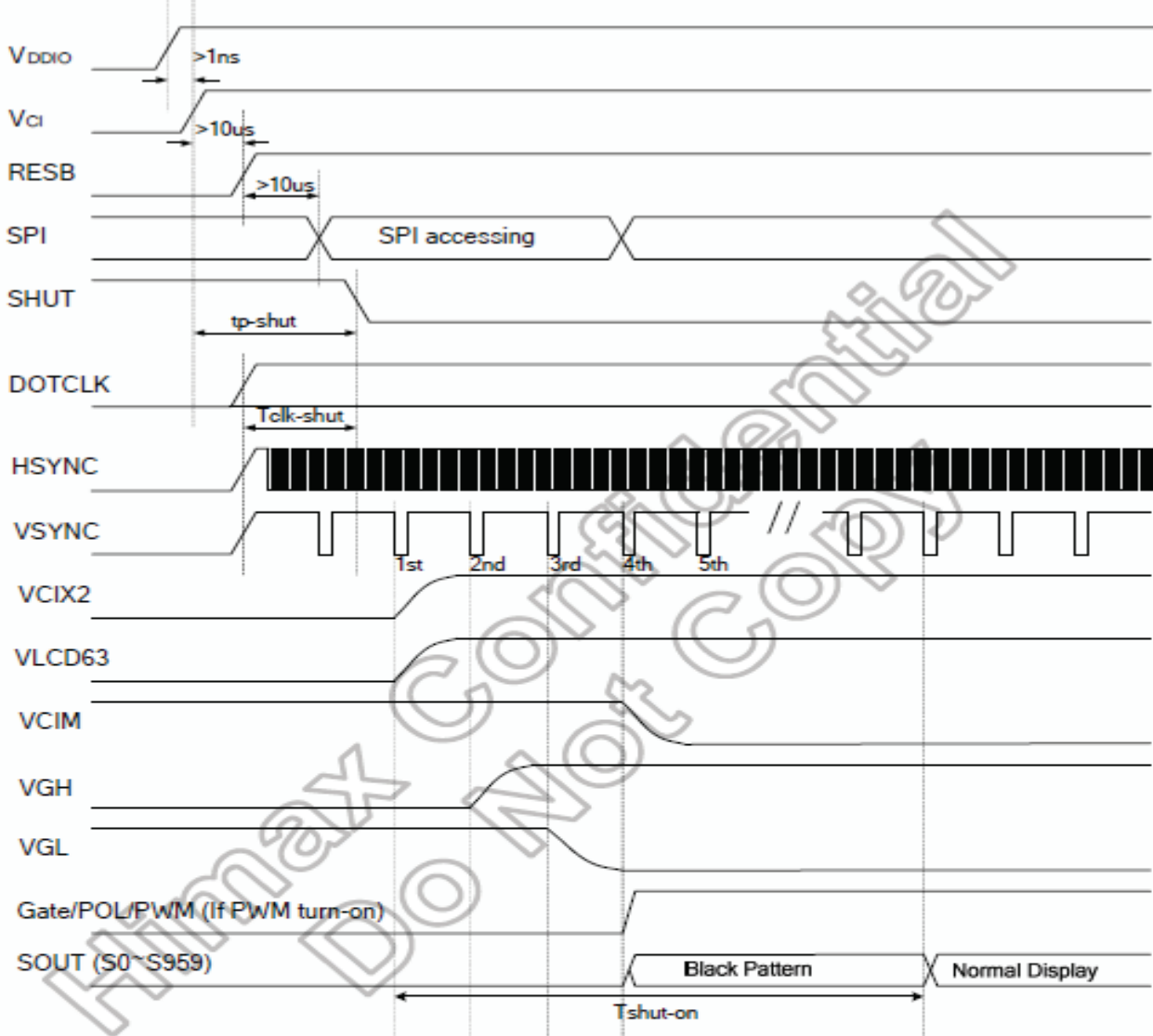

Figure 12. 10 Power Up Sequence

Characteristics	Symbol	Spec.			Unit
		Min.	Typ.	Max.	
VDDD / VDDIO on to falling edge of SHUT	$tp-shut$	1	-	-	μs
DOTCLK	$tclk-shut$	1	-	-	clk
Falling edge of SHUT to display start	$tshut-on$	-	-	14	frame
- 1 line: 408 clk - 1 frame: 262 line - DOTCLK = 6.5MHz		-	166	232.4	ms

Note: It is necessary to input DOTCLK before the falling edge of SHUT.
Display starts at 10th falling edge of VSTNC after the falling edge of SHUT.

Table 12. 3 Power Up Sequence

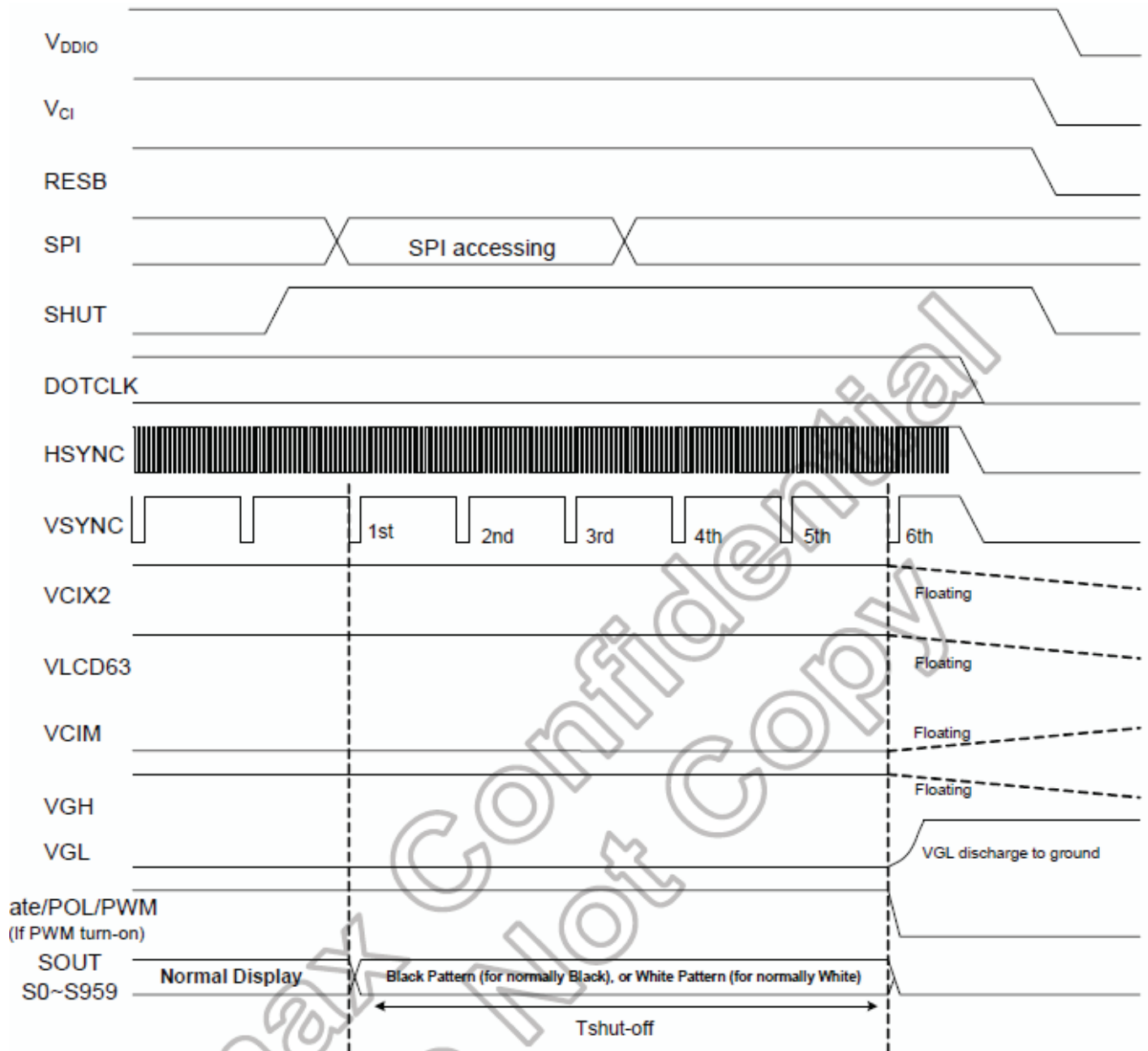

Figure 12. 11 Power Down Sequence

Characteristics	Symbol	Spec.			Unit
		Min.	Typ.	Max.	
Rising edge of SHUT to display off	tshut-off	2	-	-	frame
- 1 line: 408 clk - 1 frame: 262 line - DOTCLK = 6.5MHz		33.4	-	-	ms

Note: DOTCLK must be maintained at least 2 frames after the rising edge of SHUT.
 Display become off at the 2nd falling edge of VSTNC after the falling edge of SHUT.
 If RESET signal is necessary for power down, provide it after the 2-frames-cycle of the SHUT period.

Table 12. 4 Power Down Sequence

10. RELIABILITY TEST CONDITIONS

No.	Test item	Test condition	Inspection after test
1	High Temperature Storage	80±2°C/240 hours	Inspection after 2~4hours storage at room temperature, the sample shall be free from defects: 1.Current changing value before test and after test is 50% larger ; 2. function defect: Non-display ,abnormal-d isplay, missing lines, Short lines , ITO corrosion ; 3.visual defect: Air bubble in the LCD, Seal leak, Glass crack。
2	Low Temperature Storage	-30±2°C/240 hours	
3	High Temperature Operating	70±2°C/120 hours	
4	Low Temperature Operating	-20±2°C/120 hours	
5	Temperature Cycle	-20±2v~25~70±2°C*10cycles (30min.) (5min.) (30min.)	
6	Damp Proof Test	50°C*90% RH/120 hours	
7	Vibration Test	Frequency : 10Hz~55Hz~10Hz Amplitude :1.5mm, X ,Y ,Z direction for total 3hours (Packing condition)	
8	Dropping test	Drop to the ground from 1m height, one time, every side of carton. (Packing condition)	
9	ESD test	Voltage:±8KV R: 330Ω C: 150pF Air discharge, 10time	
Remark: 1.The test samples should be applied to only one test item. 2.Sample size for each test item is 3~5pcs. 3.For Damp Proof Test, Pure water(Resistance > 10MΩ) should be used. 4.In case of malfunction defect caused by ESD damage, if it would be recovered to normal state after resetting, it would be judged as a good part. 5.EL evaluation should be excepted from reliability test with humidity and temperature: Some defects such as black spot/blemish can happen by natural chemical reaction with humidity and Fluorescence EL has. 6.Failure Judgment Criterion: Basic Specification, Electrical Characteristic, Mechanical Characteristic, Optical Characteristic.			

11. INSPECTION CRITERION

11.1 Description

This specification is made to be used as the standard acceptance/rejection criteria for TFT LCM Product.

1. Sample plan

Sampling plan according to GB/T2828.1-2003/ISO 2859-1 : 1999 and ANSI/ASQC Z1.4-1993, normal level 2 and based on:

Major defect: AQL 0.65

Minor defect: AQL 1.5

2. Inspection condition

- Viewing distance for cosmetic inspection is about 30±5cm with bare eyes, and under an environment 600~1000lux for visual inspection and 0~200lux for function test., all directions for inspecting the sample should be within 45° against perpendicular line. (Normal temperature 18~28°C and normal humidity 60±15%RH).

- Driving voltage

The Vop value from which the most optical contrast can be obtained near the specified Vop in the specification (Within ±0.5V of the typical value at 25°C.).

3. Definition of inspection zone in LCD

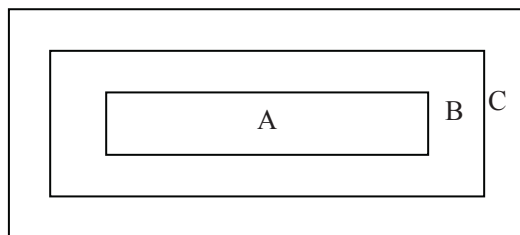

Zone A: character/Digit area

Zone B: viewing area except Zone A (Zone A+Zone B=minimum Viewing area)

Zone C: Outside viewing area (invisible area after assembly in customer's product)

Fig.1 Inspection zones in an LCD.

Note: As a general rule, visual defects in Zone C are permissible, when it is no trouble for quality and assembly of customer's product.

11.2 Inspection criterion

11.2.1 Function defect

Items to be inspected	Inspection criterion	Classification of defects
All functional defects	1) No display 2) Display abnormally 3) Missing vertical , horizontal segment 4) Short circuit 5) Back-light no lighting, flickering and abnormal lighting. 6) obvious striation 7) Current beyond specification value	MA
Missing	Missing component	
Outline dimension	Overall outline dimension exceed the drawing is not allowed.	

11.2.2 LCD pixel defect (bad dot) (defect type: MI)

Checking item	Judgment criterion		
Item/LCD size	S ≤5.0 Inch	5.0 < S≤7.0 Inch	7 < S≤12.3 Inch
Color bad dot-bright dot(R、 G、 B)	1	2	3
two adjacent bright point	0	1	2
three or more adjacent point	0	0	0
total points for bad dot-bright dot	1	2	5
Bad dot-dark dot	2	4	5
two adjacent dark point	1	2	3
three or more adjacent point	0	1	1
total points for bad dot -dark dot	3	6	7
patch bright dot	Invisible with ND5%,it is OK.		

11.2.3 dot and line defect (defect type: MI)

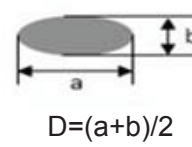
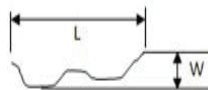
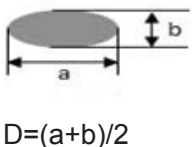
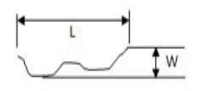
Checking item	Judgment criterion				Figure	
	Diameter(mm)\LCD Size	S ≤5.0 Inch	5 < S≤7 Inch	7 < S≤12.3 Inch		
Dot defect	D≤0.1	allowed	allowed	allowed	 <p>D=(a+b)/2</p>	
	0.1 < D≤0.2	4	allowed	allowed		
	0.2 < D≤0.3	0	5	6		
	0.3 < D≤0.5	0	0			
	D > 0.5	0	0	0		
	the distance between the two defect dot:DS≥5mm					
line defect	Length(mm)	width(mm)	Judgment criterion			
	disregard	W≤0.05	allowed	allowed		allowed
	L≤5	0.05 < W≤0.1	4	5		7
	L > 5	W > 0.1	0	0		0
Concave point and air bubble for polarizer	LCD Size(mm)		Judgment criterion		 <p>D=(a+b)/2</p>	
	D≤0.3		allowed	allowed		allowed
	0.3 < D≤1.0		3	4		5
	1.0 < D≤1.5		1	2		3
	D > 1.5		0	0		0
Fold mark, linear scar for polarizer	Length(mm)	width(mm)	Judgment criterion			
	disregard	W≤0.05	allowed	allowed		allowed
	1 < L≤5	0.05 < W≤0.2	3	4		5
	L > 5	W > 0.2	0	0		0
Notes:1.If the fold mark and linear scar for polarizer is visible with operating condition, the defect is judged with line judge ; 2.If the fold mark and linear scar for polarizer is visible with non-operating condition, the defect is judged with the above judgment standard.						

11.2.4 Corner and others crack for LCD (defect type: MI)

Checking item	Judgment criterion	Figure
electric conduction crack	$X \leq 3.0\text{mm}, Y \leq 1/4w, Z \leq t, N \leq 2$	
corner crack	$X \leq 3.0\text{mm}, Y \leq 3.0\text{mm}, Z \leq t, N \leq 3$ Corner crack extended to ITO PIN, none allowed	
surface crack	$X \leq 1.5\text{mm}, Y \leq 1.0\text{mm}, Z \leq t, N \leq 4$	

11.2.5 Module Cosmetic Criteria (defect type: MI)

Item	Judgment criterion
Difference in Spec.	None allowed
Pattern peeling	No substrate pattern peeling and floating
Soldering defects	No soldering missing No soldering bridge No cold soldering Notes: detail judgment referring to IPC-A-610 grade II
Resist flaw on Printed Circuit Boards	visible copper foil (0.5mm or more) on substrate pattern, none allowed
Accretion of metallic Foreign matter	No accretion of metallic foreign matters (Not exceed 0.2mm)
Stain	No stain to spoil cosmetic badly
Plate discoloring	No plate fading, rusting and discoloring
Newton ring	Referring to limited sample
Mura	Invisible with 5%ND, allowed
Light leaks	Referring to limited sample

12. HANDLING PRECAUTIONS

12.1 Mounting method

The LCD module consists of two thin glass plates with polarizers which easily be damaged. And since the module is so constructed as to be fixed by utilizing fitting holes in the printed circuit board. Extreme care should be needed when handling the LCD modules.

12.2 Caution of LCD handling and cleaning

When cleaning the display surface, Use soft cloth with solvent

[recommended below] and wipe lightly

- .Isopropyl alcohol
- .Ethyl alcohol

Do not wipe the display surface with dry or hard materials that will damage the polarizer surface.

Do not use the following solvent:

- .Water
- .Aromatics

Do not wipe ITO pad area with the dry or hard materials that will damage the ITO patterns

Do not use the following solvent on the pad or prevent it from being contaminated:

- .Soldering flux
- .Chlorine (Cl) , Sulfur (S)

If goods were sent without being silicon coated on the pad, ITO patterns could be damaged due to the corrosion as time goes on.

If ITO corrosion happens by miss-handling or using some materials such as Chlorine (Cl), Sulfur (S) from customer, Responsibility is on customer.

12.3 Caution against static charge

The LCD module uses C-MOS LSI drivers, so we recommend that you:

Connect any unused input terminal to V_{dd} or V_{ss}, do not input any signals before power is turned on, and ground your body, work/assembly areas, assembly equipment to protect against static electricity.

12.4 Packing

Module employs LCD elements and must be treated as such.

- .Avoid intense shock and falls from a height.
- .To prevent modules from degradation, do not operate or store them exposed direct to sunshine or high temperature/humidity

12.5 Caution for operation

- .It is an indispensable condition to drive LCD's within the specified voltage limit since the higher voltage than the limit causes the shorter LCD life.
- .An electrochemical reaction due to direct current causes LCD's undesirable deterioration, so that the use of direct current drive should be avoided.
- .Response time will be extremely delayed at lower temperature than the operating temperature range and on the other hand at higher temperature LCD's show dark color in them. However those phenomena do not mean malfunction or out of order with LCD's, which will come back in the specified operation temperature.
- .If the display area is pushed hard during operation, some font will be abnormally displayed but it resumes normal condition after turning off once.
- .A slight dew depositing on terminals is a cause for electro-chemical reaction resulting in terminal open circuit.

Usage under the maximum operating temperature, 50%Rh or less is required.

12.6 Storage

In the case of storing for a long period of time for instance, for years for the purpose or replacement use, the following ways are recommended.

- . Storing in an ambient temperature 10°C to 30°C, and in a relative humidity of 45% to 75%. Don't expose to sunlight or fluorescent light.
- . Storing in a polyethylene bag with the opening sealed so as not to enter fresh air outside in it . And with no desiccant.
- . Placing in a dark place where neither exposure to direct sunlight nor light's keeping the storage temperature range.
- . Storing with no touch on polarizer surface by the anything else.

It is recommended to store them as they have been contained in the inner container at the time of delivery from us.

12.7 Safety

- . It is recommendable to crash damaged or unnecessary LCD's into pieces and wash off liquid crystal by either of solvents such as acetone and ethanol, which should be burned up later.
- . When any liquid leaked out of a damaged glass cell comes in contact with your hands, please wash it off well with soap and water

13. PRECAUTION FOR USE

13.1 A limit sample should be provided by the both parties on an occasion when the both parties agreed its necessity. Judgment by a limit sample shall take effect after the limit sample has been established and confirmed by the both parties.

13.2 On the following occasions, the handing of problem should be decided through discussion and agreement between responsible of the both parties.

- . When a question is arisen in this specification
- . When a new problem is arisen which is not specified in this specifications
- . When an inspection specifications change or operating condition change in customer is reported to OD, and some problem is arisen in this specification due to the change
- . When a new problem is arisen at the customer's operating set for sample evaluation in the customer site.

14. PACKING SPECIFICATION

Please consult our technical department for detail information.