



ORIENT DISPLAY

Your Total LCD Solution Provider

Specification for TFT

AFC12001920A0-10.1INTM-I

Revision D



A	Orient Display
FC	TFT Type
12001920	Resolution 1200 x 1920
A0	Serial A0
10.1	10.1", Module Dimension 142.32 x 227.38 x 2.5 mm
I	IPS Display
N	Top: -20~+70°C; Tstr: -30~+80°C
T	Transmissive
M	Medium Brightness, 450 cd/m2
I	MIPI Interface
/	No Touch Panel
/	Controller HX8279-D01 Or Compatible



Revision History

Date	Rev.	Description	Note	Page
2020-8-25	A	First issue	Liu changrui	
2020-10-16	B	Update Features、 Update Absolute Maximum Ratings、 Update DC Electrical Characteristics、 Update Optical Characteristics、 Update Backlight Characteristics、 Update Interface Pin Description、 Update Block Diagram of Display、 Update Count Drawing	LCR	4、 5、 9、 10、 11
2020-11-18	C	Update DC Electrical Characteristics、 Update Interface Pin Description、 Update Block Diagram of Display、 Update Count Drawing	LCR	5、 9、 10、 11
2021-1-29	D	Update Features、 Update Absolute Maximum Ratings、 Update DC Electrical Characteristics、 Update Interface Pin Description、 Update Block Diagram of Display、 Update Count Drawing、 Update Reliability	LCR	4、 5、 9、 10、 11、 12

Contents

1. Features	4
2. Mechanical Specifications	4
3. Absolute Maximum Ratings.....	4
4. DC Electrical Characteristics.....	5
5. Optical Characteristics	5
6. Backlight Characteristics.....	9
7. Interface Pin Description.....	9
8. Block Diagram of Display.....	10
9. Count Drawing.....	11
10. Timing Characteristics.....	12
11. Reliability	12
12. Specification of Quality Assurance.....	13
13. Package Specification	19
14. Precaution for Using LCD Module.....	19

1. Features

Item	Standard Value
Display Type	1200(RGB)*1920 Dots
LCD Type	Color TFT , Transmissive
Screen Size (inch)	10.1
Viewing Direction	Free
Backlight	White
Weight	About 172g
Interface	MIPI
Other (controller/driver IC)	HX8279-D01

2. Mechanical Specifications

Item	Standard Value	Unit
Outline Dimension	142.32(L)*227.38(W)*2.5(T)	mm
Active Area	135.36(L)*216.58(W)	mm
Dots Pitch	0.0376(L)*0.1128(W)	mm

3. Absolute Maximum Ratings

Item	Symbol	Condition	Min.	Max.	Unit
Power Supply Voltage (Analog)	V _{DDA}	-	-0.3	3.6	V
Power Supply Voltage (I/O)	V _{DDI}	-	-0.3	2.1	V
Logic Input Voltage	V _{IN}	-	-0.3	V _{DDI}	V
Logic Output Voltage	V _O	-	-0.3	V _{DDI}	V
Operating Temperature	T _{OP}	-	-20	70	°C
Storage Temperature	T _{ST}	-	-30	80	°C
Humidity	-	T _A ≒ 40°C	-	90%	RH

4. DC Electrical Characteristics

Item	Symbol	Condition	Min.	Typ.	Max.	Unit
Power Supply	VDD	-	1.7	1.8	2.0	V
	VSP	-	4.5	-	6.0	V
	VSN	-	-6.0	-	-4.5	V
"H" Input Voltage	V _{IH}	-	0.8*VDDI		VDDI	V
"L" Input Voltage	V _{IL}	-	VSS		0.2VDDI	V
"H" Output Voltage	V _{OH}	I _{OH} = -1.0mA	0.8*VDDI		VDDI	V
"L" Output Voltage	V _{OL}	I _{OL} = +1.0mA	VSS		0.2VDDI	V
Supply Current	I _{DD}	Normal	-	40	-	mA
		Stand-by	-	-	-	mA
TFT gate on voltage	VGH	--	-	21	-	V
TFT gate off voltage	VGL	--	-	-7	-	V
TFT common electrode voltage	V _{com}	-	-	0	-	V
TFT operation frame rate	Hz	-	-	-	-	Hz

5. Optical Characteristics

Item	Symbol	Conditions	Min.	Typ.	Max.	Reference	
View Angle	Top	C _{≥10}	80	85	-	Notes 1 & 2	
	Bottom		80	85	-		
	Left		80	85	-		
	Right		80	85	-		
CIE *1	White	TA=25° ΘX, ΘY=0°	0.235	0.285	0.335	Notes 5	
			Y	0.260	0.310		0.360
	Red		X	0.590	0.640		0.690
			Y	0.295	0.345		0.395
	Green		X	0.265	0.315		0.365
			Y	0.525	0.575		0.625
	Blue		X	0.090	0.140		0.190
			Y	0.020	0.070		0.120
Uniformity	-	-	80%	-	-	Note 4	
Contrast Ratio	Cr	θY = 5°, Ø = 0°	800	1000	-	Note 3	
Surface Brightness	L	Ø = 0°	360cd/m ²	450cd/m ²	-	Note 3 & 4	
Color Saturation	NTSC	-	-	65	-	-	
Response Time	Tr + Tf	Ø = 0°	-	25ms	-	Note 2	

*1: This value will be changed while mass product.

Note 1.

Optical characteristics-2

Viewing angle

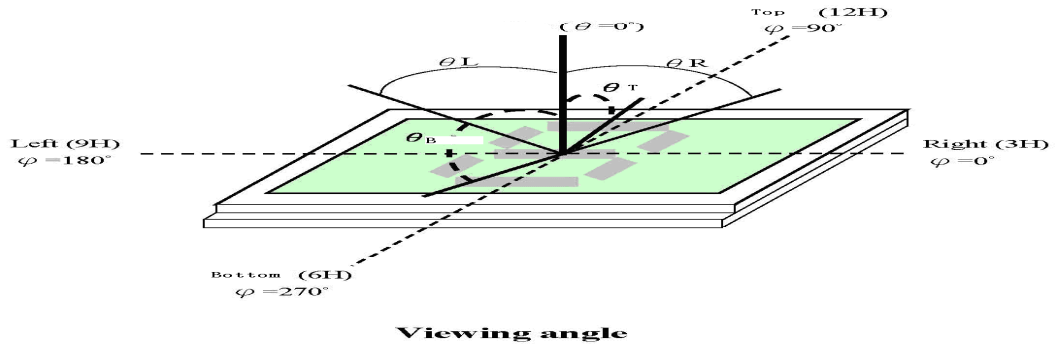

Note 2.

Optical characteristics-3

Fig.2 Definition of response time

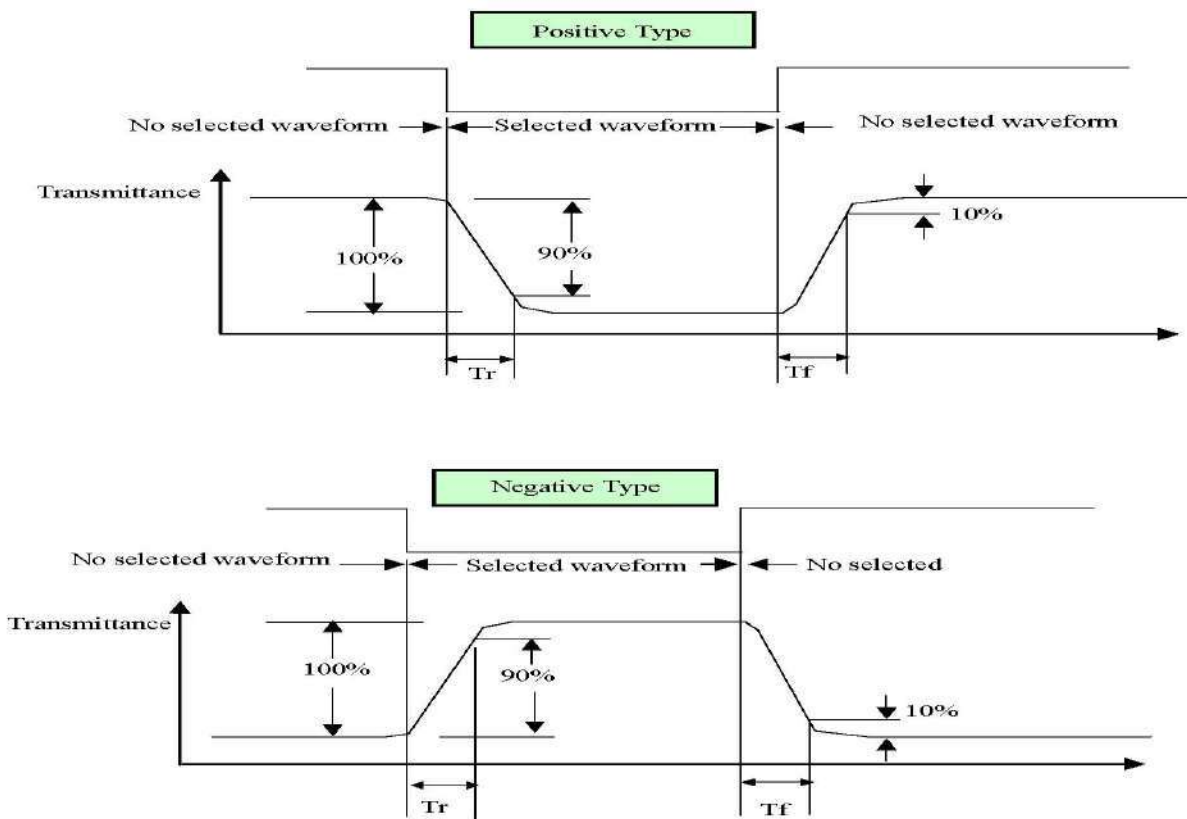

Electrical characteristics-2

※2 Drive waveform

V_{op} : Drive voltage f_F : Frame frequency

$1/B$: Bias f_D : Drive frequency

N : Duty

(1) Selected waveform

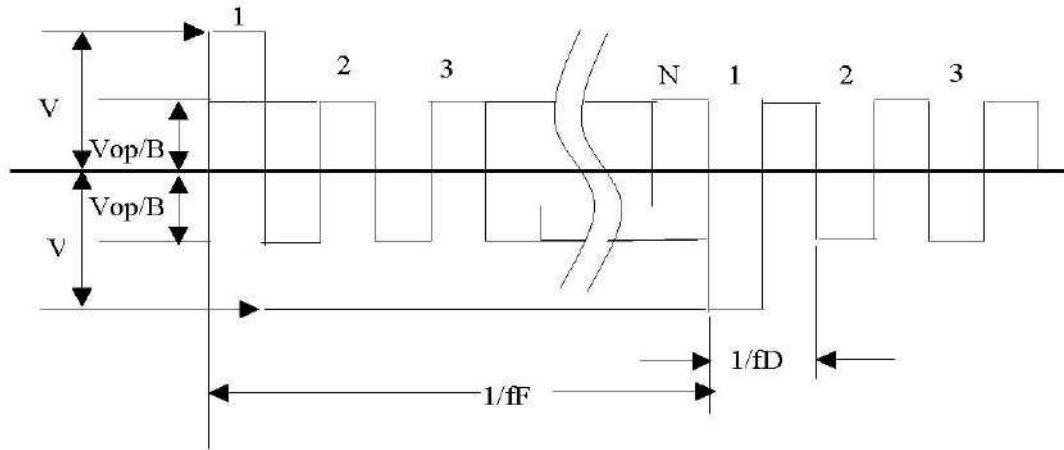

(2) Non- Selected wave form

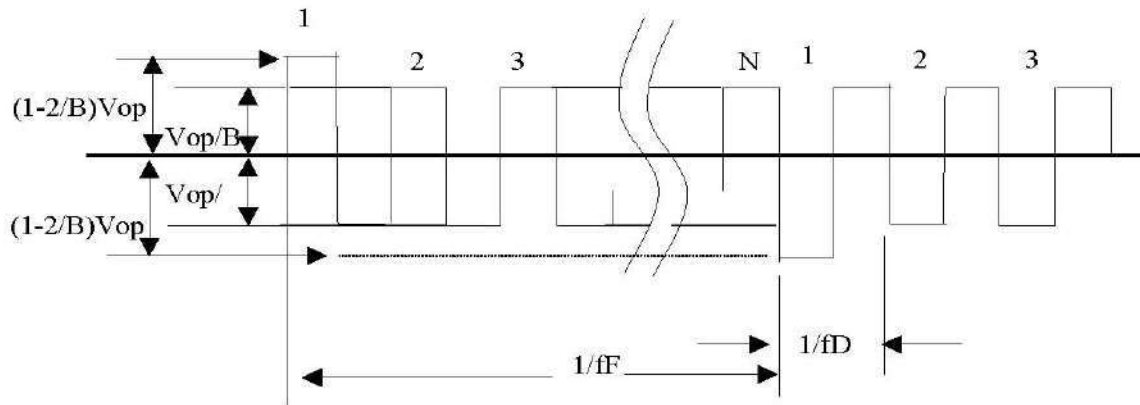

Note:

Frame frequency is defined as follows: Common side supply
voltage peak - to - peak / 2 = 1 period

Note 3. : Definition of Vth

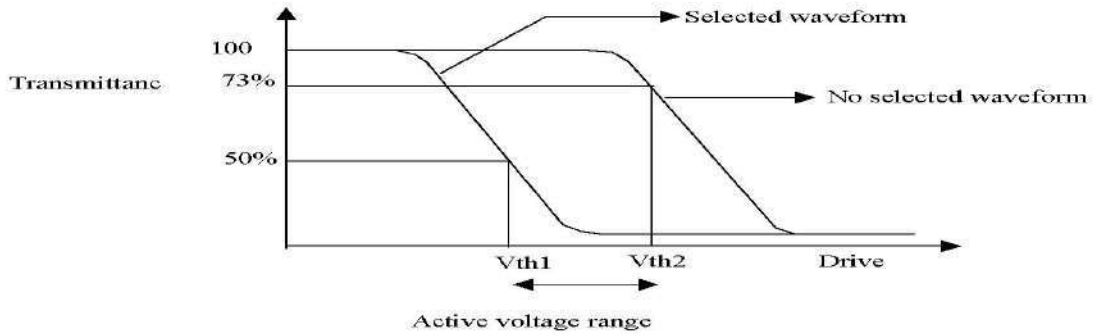

	Vth1	Vth2
View direction	10°	40°
Drive waveform	(Selected waveform)	(No selected waveform)
Transmittance	50%	73%

※I Contrast ratio
 = (Brightness in OFF state) / (Brightness in ON state)

Outline of Electro-Optical Characteristics Measuring System

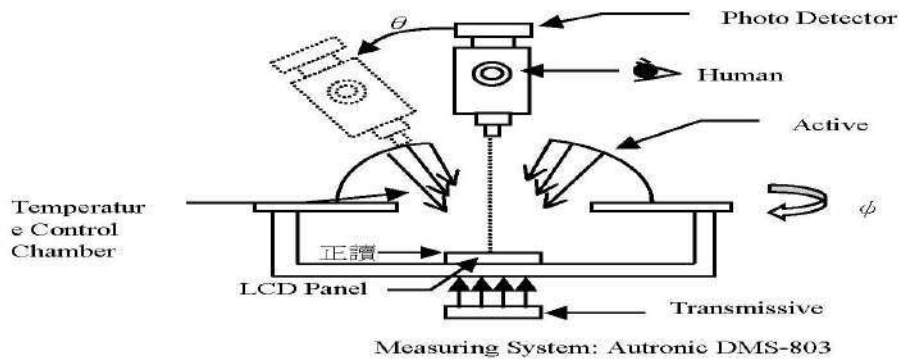

Note 4. Definition of Surface Luminance, Uniformity. (Ref Fig1)

Surface Luminance: LV=average (LP1:LP9)

Uniformity=Minimal (LP1:LP9)/Maximal (LP1:LP9) * 100%

Color Coordinate: The test condition is at IF current of backlight and measured on the surface of LCD module.

Note 5. CIE (x, y) chromaticity is the Center point value. (Ref Fig1)

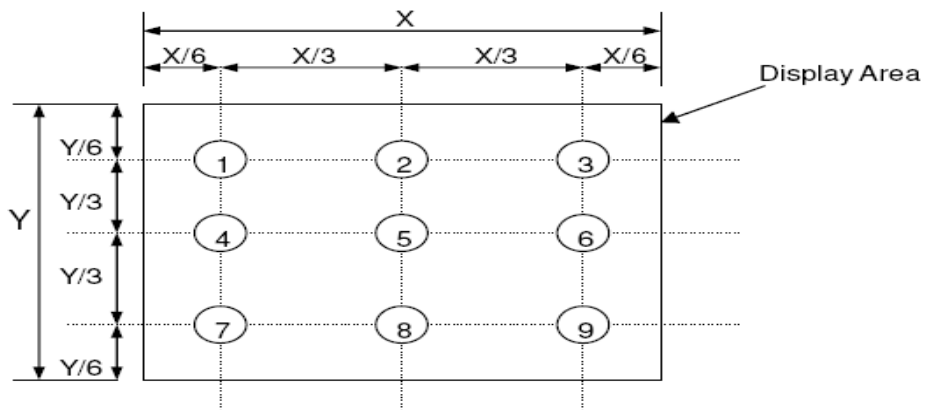

Fig1

6. Backlight Characteristics

Item	Symbol	Conditions	Min.	Typ.	Max.	Unit
Forward Voltage (30 LED)	V_F	$I_F=100\text{mA}$	34.8	36	37.2	V
Forward Current	I_F	-	-	100	-	mA
LED Life time (50% initial brightness)	$T_a=25^\circ\text{C}$, $I_F=100\text{mA}$		30000H minimum			
Color	White					

7. Interface Pin Description

Pin No.	Symbol	Function
1	VSP	Power Supply 5.4V
2	VSP	Power Supply 5.4V
3	NC	No connect
4	VSN	Power Supply -5.4V
5	VSN	Power Supply -5.4V
6	VDD3V3	Power Supply 3.3V
7	VDD1V8	Power Supply 1.8V
8	VDD1V8	Power Supply 1.8V
9	NC	No connect
10	RESET	LCM Reset (1.8V)
11	GND	Ground
12	D2P	MIPI Different Data Input
13	D2N	MIPI Different Data Input
14	GND	Ground
15	D1P	MIPI Different Data Input
16	D1N	MIPI Different Data Input
17	GND	Ground
18	CLKP	MIPI Different Clock Input
19	CLKN	MIPI Different Clock Input
20	GND	Ground
21	D0P	MIPI Different Data Input
22	D0N	MIPI Different Data Input
23	GND	Ground
24	D3P	MIPI Different Data Input
25	D3N	MIPI Different Data Input
26	GND	Ground
27	LB1	LED Cathode(-)
28	LB2	LED Cathode(-)

29	LB3	LED Cathode(-)
30	LB4	LED Cathode(-)
31	NC	No connect
32	VLED	LED Anode(+)
33	VLED	LED Anode(+)
34	NC	No connect

8. Block Diagram of Display

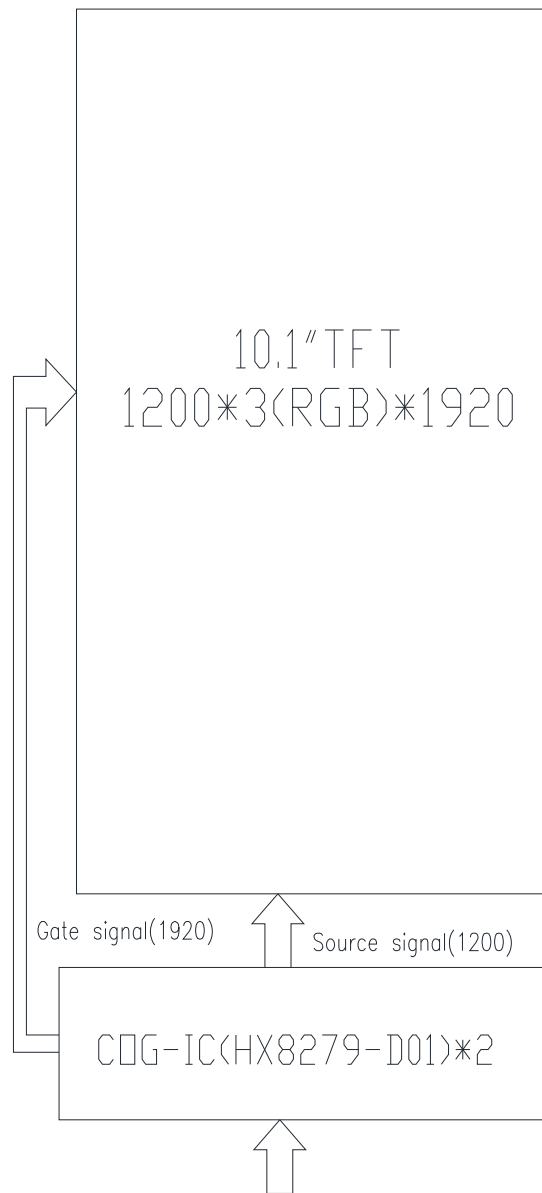

VSP VSN VDD3V3 VDD1V8 GND RESET D2P/N D1P/N CLKP/N D0P/N D3P/N VLED LB1-4

9. Count Drawing

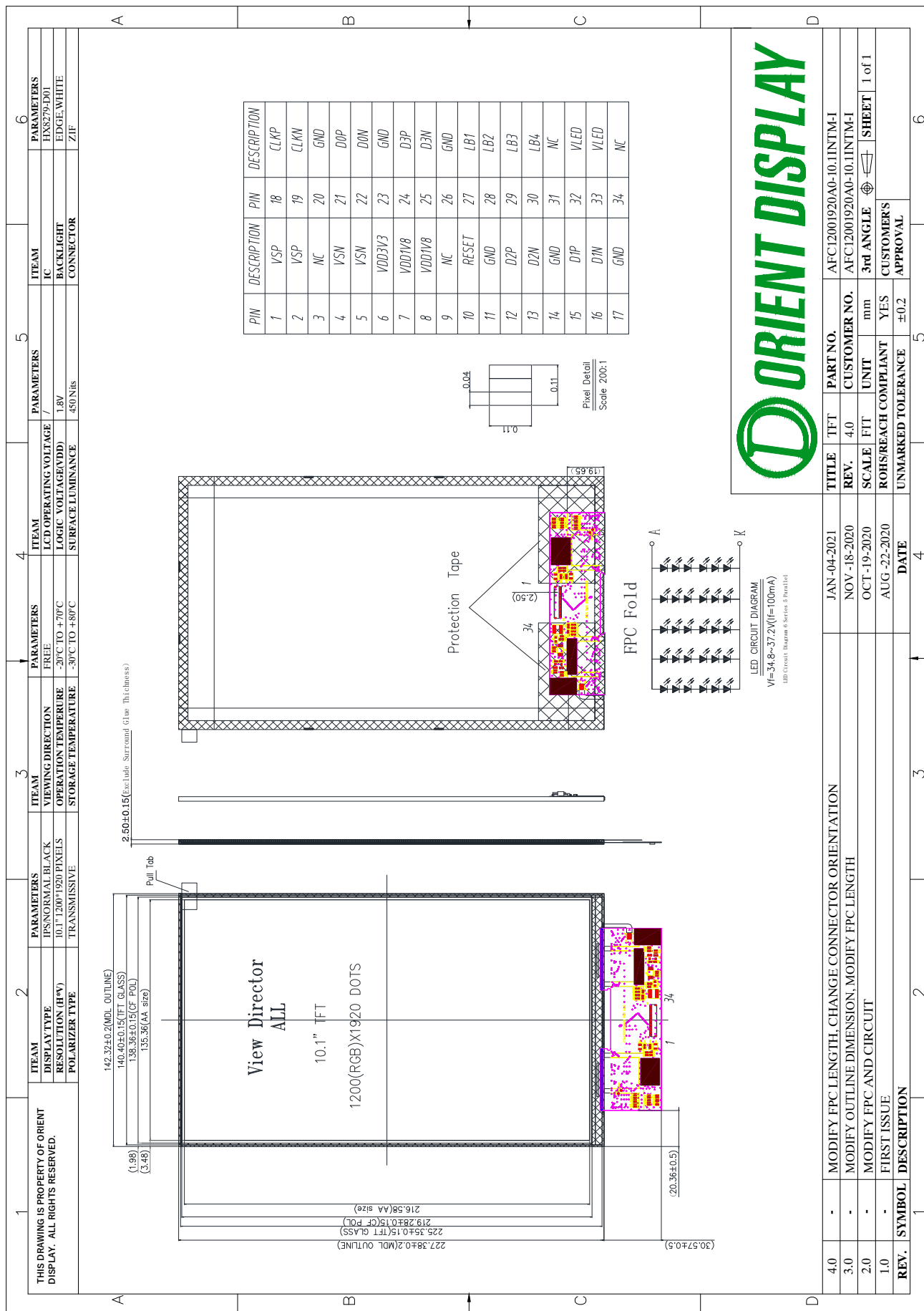

10. Timing Characteristics

Please references HX8279-D01 data sheet.

11. Reliability

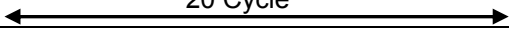
NO	Item	Test Condition
1	High Temperature Storage	Storage at $70 \pm 2^\circ\text{C}$ 96 hrs Surrounding temperature, then storage at normal condition 4hrs
2	Low Temperature Storage	Storage at $-30 \pm 2^\circ\text{C}$ 96 hrs Surrounding temperature, then storage at normal condition 4hrs
3	High Temperature Operation	Operation at $60 \pm 2^\circ\text{C}$ 96 hrs
4	Low Temperature Operation	Operation at $-20 \pm 2^\circ\text{C}$ 96 hrs
5	High Temperature /Humidity Operating	Operation at $40 \pm 2^\circ\text{C}$, 90%RH 96 hrs surrounding temperature, then storage at normal condition 4hrs.
6	Thermal shock (non-operation)	$-20^\circ\text{C} \rightarrow 25^\circ\text{C} \rightarrow 60^\circ\text{C} \rightarrow 25^\circ\text{C}$ (30mins) (5mins) (30mins) (5mins) 20 Cycle 
7	Mechanical Test	Freq.: 10-55Hz Max. Acceleration: 5G X.Y.Z. each direction For 10 mines.
		Drop them through 50cm height to strike horizontal plane
8	ESD Test	Air Discharge: Apply +/-6KV with 5 times Discharge for each polarity +/-
		Contact Discharge: Apply +/-4KV with 5 times Discharge for each polarity +/- 1. Temperature ambience: $15^\circ\text{C} \sim 35^\circ\text{C}$ 2. Humidity relative: 30%~60% 3. Energy Storage Capacitance (Cs + Cd): 150pF+/-10% 4. Discharge Resistance (Rd): 330Ω +/-10% 5. Discharge, mode of operation: Single Discharge (time between successive discharges at least 1 sec) (Tolerance if the output voltage indication: +/-5%)

Note 1. For humidity test, DI water should be used

Inspection Standard: Inspect after 1-2hrs storage at room temperature, the sample shall be free from the following defects:

- Air bubble in the LCD
- Seal Leakage
- Non-display
- Missing Segment
- Glass Crack
- IDD is greater than twice initial value
- Others as per QA Inspection Criteria

Note 2. No defect is allowed after testing.

Note 3. ESD should be applied to LCD glass panel, not other areas (such as on IC and so on)
IDD should be within twice initial value.

In case of malfunction defect caused by ESD damage, if it would be recovered to normal state after resetting, it would be judged as a good part.

Note 4. Only upon request.

12. Specification of Quality Assurance

12.1 Purpose

This standard for Quality Assurance assures the quality of LCD module products supplied to customer by ODNA.

12.2 Standard for Quality Test

ODNA performs the following tests to ensure the quality of product before shipment.

12.2.1 Sampling Plan:

GB/T2828.1-2003. Single sampling, General Inspection Level II.

Single sampling, normal inspection

12.2.2 Sampling Criteria:

Minor Defect: AQL 0.65%

Major Defect: AQL 0.15%

12.2.3 Defect class defining:

Minor Defect: Not Impact function of product;

Major Defect: Impact the function of product;

Critical Defect: Impact safety, or not conformity with law.

12.2.4 Reliability Test:

Detailed requirement refers to Reliability Test Specification.

12.2.5 Nonconforming Analysis & Disposition

12.2.6 Nonconforming analysis

12.2.6.1 Customer should provide overall information of non-conforming sample for their complaints.

12.2.6.2 After receipt of detailed information from customer, the analysis of nonconforming parts usually should be finished in one week.

12.2.6.3 If ODNA can not finish the analysis on time, customer will be notified with the progress status.

12.2.6.4 Disposition of nonconforming:

12.2.6.5 Non-conforming product over ppm level will be replaced.

12.2.6.6 The cause of non-conformance will be analyzed. Corrective action will be discussed and implemented.

12.3 Agreement Items

ODNA and customer shall negotiate if the following situation occurs

12.3.1 There is any discrepancy in standard of quality assurance.

12.3.2 Additional requirement to be added in product specification.

12.3.3 Any other special problem.

12.4 Standard of the Product Visual Inspection

12.4.1 Appearance inspection

12.4.1.1 The normal inspection must be under illumination no less than 800lux, and the distance of view must be between 30cm and 45cm;

12.4.1.2 When inspect the model of transmissive product, back light must be lighted.

12.4.1.3 The visual viewing angle should be 45° from the vertical line without reflection shine or follows customer's viewing angle specifications.

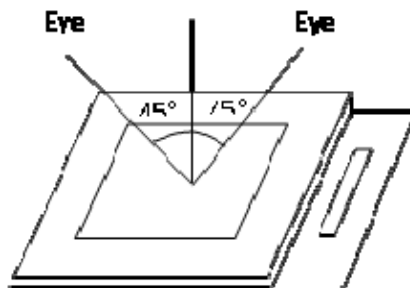

12.4.1.4 Definition of area :(refer to product drawing)

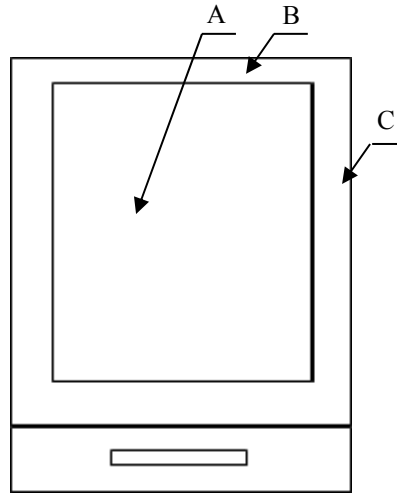

- A. Display Area
- B. Viewing Area
- C. Out of viewing area

12.4.2 Basic principle:

12.4.2.1 According to IPC standards if standard is not described in specification.

12.4.2.2 A set of samples to indicate the limit of acceptable quality level must be discussed by both ODNA and customer when there is any dispute happened. 12.4.2.3 New item must be added on time when it is necessary.

12.5 Inspection Specification:

No.	Item	Criteria (Unit: mm)		
Functional				
01	LC leakage	LC leakage	Reject	Maj
02	Non-display	Non-display	Reject	Maj
03	Missing segment/ Missing character, dot or icon.	<p style="text-align: center;">OK NG</p>	Reject	Maj
04	Exceeded dot/line/segment /Distortion	<p style="text-align: center;">OK NG</p>	Reject	Maj
05	Dim Display	part of figures display dim than normal obviously	As the samples confirmed each other	Min
06	Wrong view angle	View angle is different from spec.	Reject	Maj
07	Not light	1.Backlight not work 2. Some LED not light	Reject	Maj
08	Backlight Luminance \	According to the product specification or limited samples	Reject	Min

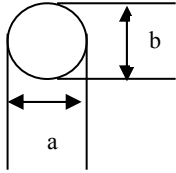
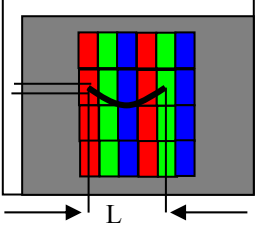
	uniformity																																				
09	Backlight Color	According to the product specification or limited samples	Reject	Min																																	
10	Connection failure	FPC gold finger damage	Reject	Maj																																	
Cosmetic																																					
01	Black and white spot, Red, blue and green spot Dent Foreign material (Round type)	 $\phi = (a + b) / 2$ Distance between 2 defects should more than 10 mm apart.	<table border="1"> <thead> <tr> <th rowspan="2">Size(mm)</th> <th colspan="3">Area</th> </tr> <tr> <th>Zone A</th> <th>Zone B</th> <th>Zone C</th> </tr> </thead> <tbody> <tr> <td>$\phi \leq 0.2$</td> <td colspan="2">Ignore</td> <td>NC</td> </tr> <tr> <td>$0.2 < \phi \leq 0.3$</td> <td colspan="2">3</td> <td>NC</td> </tr> <tr> <td>$0.30 < \phi \leq 0.5$</td> <td colspan="2">2</td> <td>NC</td> </tr> <tr> <td>$\phi > 0.50$</td> <td colspan="2">0</td> <td>NC</td> </tr> <tr> <td>Total</td> <td colspan="2">5</td> <td>NC</td> </tr> </tbody> </table>	Size(mm)	Area			Zone A	Zone B	Zone C	$\phi \leq 0.2$	Ignore		NC	$0.2 < \phi \leq 0.3$	3		NC	$0.30 < \phi \leq 0.5$	2		NC	$\phi > 0.50$	0		NC	Total	5		NC	Min						
Size(mm)	Area																																				
	Zone A	Zone B	Zone C																																		
$\phi \leq 0.2$	Ignore		NC																																		
$0.2 < \phi \leq 0.3$	3		NC																																		
$0.30 < \phi \leq 0.5$	2		NC																																		
$\phi > 0.50$	0		NC																																		
Total	5		NC																																		
02	Black and White line Scratch Foreign material (Line type) (Min)	 Distance between 2 defects should more than 10mm apart.	<table border="1"> <thead> <tr> <th rowspan="2">Length (mm)</th> <th rowspan="2">Width (mm)</th> <th colspan="3">Acc. Qty</th> </tr> <tr> <th>Zone A</th> <th>Zone B</th> <th>Zone C</th> </tr> </thead> <tbody> <tr> <td>/</td> <td>$W \leq 0.03$</td> <td colspan="2">Ignore</td> <td>NC</td> </tr> <tr> <td>$L \leq 5$</td> <td>$0.03 < W \leq 0.05$</td> <td colspan="2">3</td> <td>NC</td> </tr> <tr> <td>$L \leq 3$</td> <td>$0.05 < W \leq 0.1$</td> <td colspan="2">2</td> <td>NC</td> </tr> <tr> <td></td> <td>$W > 0.10$</td> <td colspan="2">0</td> <td>NC</td> </tr> <tr> <td colspan="2">Total</td> <td colspan="2">5</td> <td>NC</td> </tr> </tbody> </table>	Length (mm)	Width (mm)	Acc. Qty			Zone A	Zone B	Zone C	/	$W \leq 0.03$	Ignore		NC	$L \leq 5$	$0.03 < W \leq 0.05$	3		NC	$L \leq 3$	$0.05 < W \leq 0.1$	2		NC		$W > 0.10$	0		NC	Total		5		NC	Min
Length (mm)	Width (mm)	Acc. Qty																																			
		Zone A	Zone B	Zone C																																	
/	$W \leq 0.03$	Ignore		NC																																	
$L \leq 5$	$0.03 < W \leq 0.05$	3		NC																																	
$L \leq 3$	$0.05 < W \leq 0.1$	2		NC																																	
	$W > 0.10$	0		NC																																	
Total		5		NC																																	
03	Polarizer concave and convex/bubbles	<table border="1"> <thead> <tr> <th rowspan="2">Diameter: Φ(mm)</th> <th colspan="3">Accept Qty</th> </tr> <tr> <th>Zone A</th> <th>Zone B</th> <th>Zone C</th> </tr> </thead> <tbody> <tr> <td>$\Phi < 0.2\text{mm}$</td> <td colspan="2">Ignore</td> <td rowspan="3">Ignore</td> </tr> <tr> <td>$0.2\text{mm} < \Phi \leq 0.5\text{mm}$</td> <td colspan="2">4</td> </tr> <tr> <td>$0.5\text{mm} < \Phi \leq 0.7\text{mm}$</td> <td colspan="2">2</td> </tr> <tr> <td>$\Phi > 0.7\text{mm}$</td> <td colspan="3">Unacceptable</td> </tr> </tbody> </table> Distance between 2 defects should more than 10mm apart.	Diameter: Φ (mm)	Accept Qty			Zone A	Zone B	Zone C	$\Phi < 0.2\text{mm}$	Ignore		Ignore	$0.2\text{mm} < \Phi \leq 0.5\text{mm}$	4		$0.5\text{mm} < \Phi \leq 0.7\text{mm}$	2		$\Phi > 0.7\text{mm}$	Unacceptable				Min												
Diameter: Φ (mm)	Accept Qty																																				
	Zone A	Zone B	Zone C																																		
$\Phi < 0.2\text{mm}$	Ignore		Ignore																																		
$0.2\text{mm} < \Phi \leq 0.5\text{mm}$	4																																				
$0.5\text{mm} < \Phi \leq 0.7\text{mm}$	2																																				
$\Phi > 0.7\text{mm}$	Unacceptable																																				
04	Bright/Dark dots, lines, Pixel defects	*A dot is defined as a single sub-pixel (either red, green, or blue) within a pixel.	Allow	Min																																	

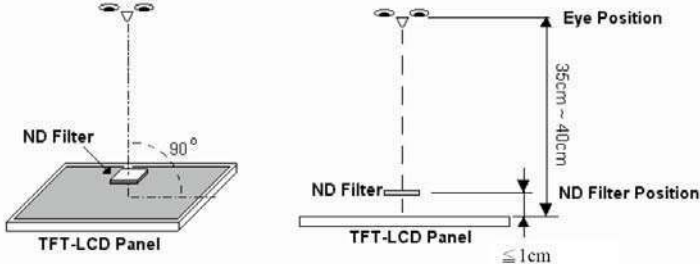
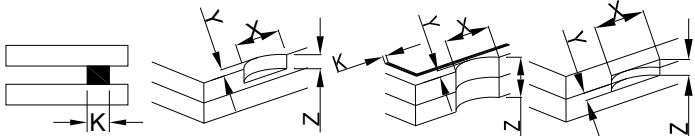
		<p>Definition of Bright dots: Dots that can be seen through 6% ND filter.</p> <table border="1"> <tr> <td>Bright dots</td> <td>2</td> </tr> <tr> <td>Adjacent bright dots</td> <td>0</td> </tr> <tr> <td>Dark dots</td> <td>4</td> </tr> <tr> <td>Adjacent dark dots</td> <td>0</td> </tr> <tr> <td>Tiny bright dots</td> <td>Judge by 6% ND filter, check with 30cm distance, if still can see, NG</td> </tr> <tr> <td>Mura (50% GERY)</td> <td>Judge by 6% ND filter, check with 30cm distance, if still can see, NG</td> </tr> <tr> <td>Dark or Bright Lines</td> <td>0</td> </tr> <tr> <td>Blank pixel/ Missing pixel</td> <td>Not allow</td> </tr> </table> <p>Remark: One pixel consists of 3 sub-pixels, including R, G and B dot (Sub-pixel=Dot)</p> <p>Note 1 Bright dot is defined through 6% transmission ND filter as following:</p>  <p>Defects on the black Matrix, out of viewing area, aren't considered as a defect counted.</p>	Bright dots	2	Adjacent bright dots	0	Dark dots	4	Adjacent dark dots	0	Tiny bright dots	Judge by 6% ND filter, check with 30cm distance, if still can see, NG	Mura (50% GERY)	Judge by 6% ND filter, check with 30cm distance, if still can see, NG	Dark or Bright Lines	0	Blank pixel/ Missing pixel	Not allow	
Bright dots	2																		
Adjacent bright dots	0																		
Dark dots	4																		
Adjacent dark dots	0																		
Tiny bright dots	Judge by 6% ND filter, check with 30cm distance, if still can see, NG																		
Mura (50% GERY)	Judge by 6% ND filter, check with 30cm distance, if still can see, NG																		
Dark or Bright Lines	0																		
Blank pixel/ Missing pixel	Not allow																		
05	TFT Glass cracked	<p>Symbols X: Chip length Y: Chip width Z: Chip thickness T: Glass thickness L: Electrode pad length a) General glass chip 1. Chip on panel surface and crack between panels</p>  <table border="1"> <thead> <tr> <th>Z: Chip thickness</th> <th>Y: Chip width</th> <th>X: Chip length</th> </tr> </thead> <tbody> <tr> <td>$Z \leq 1.2T$</td> <td>Not expanded in viewing area</td> <td>$X \leq 1/8A$</td> </tr> <tr> <td>$1/2T < Z \leq 2T$</td> <td>Not exceed 1/3K</td> <td>$X \leq 3mm$</td> </tr> </tbody> </table> <p>If there are 2 or more chips, X is the total length of each chip. 2. Corner crack:</p>	Z: Chip thickness	Y: Chip width	X: Chip length	$Z \leq 1.2T$	Not expanded in viewing area	$X \leq 1/8A$	$1/2T < Z \leq 2T$	Not exceed 1/3K	$X \leq 3mm$	Min							
Z: Chip thickness	Y: Chip width	X: Chip length																	
$Z \leq 1.2T$	Not expanded in viewing area	$X \leq 1/8A$																	
$1/2T < Z \leq 2T$	Not exceed 1/3K	$X \leq 3mm$																	

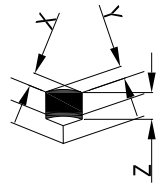

X, Y, Z Spec. same as a.1. If there are 2 or more chips, X is the total length of each chip.

- b) Protrusion over terminal:
1. Chip on electrode pad

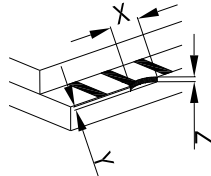

Y: Chip width	X: Chip length	Z: Chip thickness
$Y \leq 1/4 L$	$X \leq 3\text{mm}$	$0 < Z \leq T$

2. Non-conductive portion

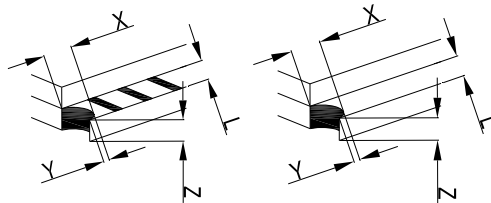

Y: Chip width	X: Chip length	Z: Chip thickness
$Y \leq 1/3 L$	$X \leq 3\text{mm}$	$0 < Z \leq T$

If the chipped area reaches the ITO terminal, over 2/3 of the ITO must be remained.

If the product will be heat sealed by the customer, the alignment mark must not be damaged.

3. Substrate protuberance and internal crack

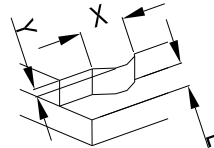

Y: Width	X: Length
$Y \leq 1/4 L$	$X \leq A$

- c) LCD with extensive crack line is unacceptable.

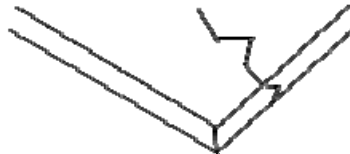

06	Discolor/rainbow	Discolor between the LCDs or in the same LCD	Refer to the limit samples signed by customers or ODNA	Min
07	FPC/FFC/TAB/HSC	Connect surface oxidation	Not allow	Maj
		Etching/damage /distortion	Not exceed 1/3 width of wire	Min
		Connect surface contamination /foreign material	Width & length of electric foreign material could not exceed the width of 2 pins	Min

		Connect surface scratch	The scratch depth not exceed 1/2 thickness of gold layer.	Min
		Copper/protective film/base board film separates	Not allow	Maj
		Others: FPC follow IPC-6013A standard.		
08	Soldering	Cold soldering, short soldering	Reject	Min
		Not enough solder paste	Solder paste area < 75% solder pad area Solder paste area < 75% component solder point Solder paste height < 1/2 component height	Min
		FPC Pin deviation	Deviation area > 1/3 Solder pad	Min
		Others: Follow IPC-A-610E standard		
09	COG silicon coating	a) Not exceed the surface of top polarizer, LCD left/right edges. Cover fully ITO, IC and the juncture of HSC/FPC and LCD. b) No visible non-metal foreign material and metal material in coating c) Entrapped air bubble isn't permissible to exist on the juncture of coating glue and pins of LCD. d) Bubbles or pinhole of silicon coating should $\Phi \leq 2\text{mm}$ e) The silicon should cover all around the IC and not gap in between silicon and side of IC, lack of coating on top of IC can be accepted		Min
10	Glass warping	Product diagonal length (mm)	Warp page range (mm)	Maj
		$L \leq 10$	0.05	
		$10 < L \leq 30$	0.1	
		$30 < L \leq 100$	0.2	
		$100 < L \leq 300$	0.4	
		$300 < L \leq 1000$	0.6	
		$1000 < L \leq 3000$	0.8	
11	Color of silk Screen	Refer to limit sample or measurement data base on SPEC		Min

12	Backlight	1.Spots or scratches that appear when light must be judged using LCD glass spot, line and contamination standards. 2.Brightness and Chromaticity can't be out of specification.		Min	
13	Bezel	a) No rust, distortion on the Bezel.		Min	
		b) No visible fingerprints, stains or other contamination.			
		Dent	1 mm > Ø > 0.5 mm, 2个	Accept	Min
			Ø≤0.5 mm	Ignore	Min
		Exposed base metal material on front surface	Ø≤0.5 mm ,2个	Accept	Min
		Exposed base meta material on side	Dot : Ø≤1.0mm, Line: L≤2.0mm、 W≤0.5mm	Accept	Min
Scratched	Exposed base metal material	Reject	Min		

12.6 ROHS Compliance

The product should ROHS Compliance.

13. Package Specification

TBD

14. Precaution for Using LCD Module

14.1 Handing Precaution

- 14.1.1 The display panel is made of glass and polarizer. As glass is fragile. It tends to become or chipped during handing especially on the edges. Please avoid dropping or jarring. Do not subject it to a mechanical shock by dropping it or impact.
- 14.1.2 If the display panel is damaged and the liquid crystal substance leaks out, be sure not to get any in your mouth. If the substance contacts your skin or clothes, wash it off using soap and water.
- 14.1.3 Do not apply excessive force to the display surface or the adjoining areas since this many cause the color tone to vary. Do not touch the display with bare hands, this will stain the display area and degraded insulation between terminals (some cosmetics are determined to the polarizer).
- 14.1.4 The polarizer covering the display surface of the LCD module is soft and easily scratched. Handle this polarizer carefully. Do not touch, push or rub the exposed polarizer with anything harder than an HB pencil lead (glass, tweezers, etc.). Do not put or attach anything on the display area to avoid leaving marks on it. Condensation on the surface and contact with terminals due to cold will damage, stain or dirty the polarizer. After products are tested at low temperature they must be warmed up in a container before coming in to contact with room temperature air.

- 14.1.5 If the display surface becomes contaminated, breathe on the surface and gently wipe it with a soft dry cloth. If it is heavily contaminated, moisten cloth with one of the following solvents, Isopropyl alcohol or Ethyl alcohol; do not scrub hard to avoid damaging the display surface.
- 14.1.6 Solvents other than those above-mentioned badly damage the polarizer. Especially, do not use the following: water, Ketone, Aromatic solvents. Wipe off saliva or water drops immediately, contact with water over a long period of time may cause deformation or color fading. Avoid contact with oil and fats.
- 14.1.7 Exercise care to minimize corrosion of the electrode. Corrosion of the electrodes is accelerated by water droplets, moisture condensation or current flow in a high-humidity environment.
- 14.1.8 Install the LCD module by using the mounting holes. When mounting the LCD module make sure it is free of twisting, warping and distortion. In particular, do not forcibly pull or bend the I/O cable or the backlight cable.
- 14.1.9 Do not attempt to disassemble or process the LCD module.
- 14.1.10 NC terminal should be open. Do not connect anything.
- 14.1.11 If the logic circuit power is off, do not apply the input signals.
- 14.1.12 Electro-Static Discharge control, since this module uses a CMOS LSI, the same careful attention should be paid to electrostatic discharge as for an ordinary CMOS IC. To prevent destruction of the elements by static electricity, be careful to maintain an optimum work environment.
- 14.1.13 Since LCM has been assembled and adjusted with a high degree of precision, avoid applying excessive shocks to the module or making any alterations or modifications to it.

14.2 Storage Precaution

- 14.2.1 Store them in a sealed polyethylene bag. If properly sealed, there is no need for the desiccant.
- 14.2.2 Store them in a dark place. Do not expose to sunlight or fluorescent light, keep the temperature between 0°C and 35°C, and keep the relative humidity between 40% RH and 60% RH.
- 14.2.3 The polarizer surface should not come in contact with any other objects (we advise you to store them in anti-static electricity container in which they were shipped).
- 14.2.4 During shipment, please handle with care. The packaging bag can not be broken, step on trap. Packaging Carton layer height can not be over two meters.
- 14.2.5 The transportation process should pay attention to the waterproof and moisture-proof measures. Product can not be watering. Ethylene sealed bags cannot be unsealed.
- 14.2.6 Liquid crystals solidify under low temperature (below the storage temperature range) leading to defective orientation or the generation of air bubbles (black or white). Air bubbles may also be generated if the module is subject to a low temperature.
- 14.2.7 If the LCD modules have been operating for a long time showing the same display patterns, the display patterns may remain on screen as ghost images and a slight contrast irregularity may also appear. A normal operating status can be regained by suspending use for some time. It should be noted that this phenomenon does not adversely affect performance reliability.
- 14.2.8 To minimize the performance degradation of the LCD modules resulting from destruction caused by static electricity etc.,

14.3 Using LCD Modules

- 14.3.1 The hole in the printed circuit board is used to fix LCM. Attend to the following items when installing the LCM. Cover the surface with a transparent protective plate to protect the polarizer and LC cell.
- 14.3.2 When assembling the LCM into other equipment, the spacer to the bit between the LCM and the fitting plate should have enough height to avoid causing stress to the module surface, refer to the individual specifications for measurements. The measurement tolerance should be +/-0.1mm.
- 14.3.3 Precaution for assemble the module with BTB connector; Please note the position of the male and female connector position.
- 14.3.4 Precaution for soldering the LCM, Manual soldering temperature $300\pm 20^{\circ}\text{C}$, time is 3~5S.
- 14.3.5 If soldering flux is used, be sure to remove any remaining flux after finishing to soldering operation (This does not apply in the case of a non-halogen type of flux). It is recommended that you protect the LCD surface with a cover during soldering to prevent any damage due to flux spatters.
- 14.3.6 When soldering the electroluminescent panel and PC board, the panel and board should not be detached more than three times. This maximum number is determined by the temperature and time conditions mentioned above, though there may be some variance depending on the temperature of the soldering iron.
- 14.3.7 When remove the electroluminescent panel from the PC board, be sure the solder has completely melted, the soldered pad on the PC board could be damaged.

14.4 Precautions for Operation

- 14.4.1 Viewing angle varies with the change of liquid crystal driving voltage (VLCD). Adjust VLCD to show the best contrast.
- 14.4.2 It is an indispensable condition to drive LCD within the specified voltage limit since the higher voltage then the limit cause the shorter LCD life. An electrochemical reaction due to direct current causes LCD undesirable deterioration, so that the use of direct current drive should be avoid.
- 14.4.3 Response time will be extremely delayed at lower temperature than the operating temperature range and on the other hand at higher temperature LCD show dark color in them. However, those phenomena do not mean malfunction or out of order with LCD which will come back in the specified operating temperature.
- 14.4.4 If the display area is pushed hard during operation, the display will become abnormal. However, it will return to normal if it is turned off and back on.
- 14.4.5 Slight dew depositing on terminals is a cause for electro-chemical reaction resulting in terminal open circuit. Usage under the maximum operating temperature, 50%RH or less is required.
- 14.4.6 Input logic voltage before apply analog high voltage such as LCD driving voltage when power on. Remove analog high voltage before logic voltage when power off the module. Input each signal after the positive & negative voltage becomes stable.
- 14.4.7 Please keep the temperature within the specified range for use and storage. Polarization degradation, bubble generation or polarizer peel-off many occur with high temperature and high humidity.

14.5 Safety

- 14.5.1 It is recommended to crush damaged or unnecessary LCD into pieces and wash them off with solvents such as acetone and ethanol, which should later be burned.
- 14.5.2 If any liquid leaks out of a damaged glass cell and comes in contact with the hands, wash off thoroughly with soap and water.

14.6 Limited Warranty

- 14.6.1 Unless otherwise agreed between ODNA display and customer, ODNA display will replace or repair any of its LCD and LCM which ODNA display found to be defective electrically and visually when inspected in accordance with ODNA display quality standards, for a period of one year from date of shipment.
- 14.6.2 The warranty liability of ODNA display is limited to repair and/or replacement. ODNA display will not be responsible for any consequential loss.
- 14.6.3 If possible, we suggest you use up all modules in six months. If the module storage time over twelve months, we suggest that recheck it before the module be used.