



SPECIFICATION FOR APPROVAL

Customer : _____
Description : DC FAN _____
Customer Part No. _____ REV. : _____
Delta Model No. : AFB0705MC-00F0R _____ REV. : 01 _____
Sample Issue No. : _____
Sample Issue Date : 9/6 2023 _____

PLEASE SEND ONE COPY OF THIS SPECIFICATION BACK AFTER YOU SIGNED APPROVAL FOR PRODUCTION PRE-ARRANGMENT.

APPROVED BY:

DATE :

DELTA ELECTRONICS, INC.
TAOYUAN PLANT
252, SHANG YING ROAD, KUEI SAN INDUSTRIAL ZONE
TAOYUAN SHIEN, TAIWAN, R.O.C.
TEL:886-(0)3-3591968
FAX:886-(0)3-3591991

Delta Electronics, Inc.
No.252, Shanying Rd., Guishan Dist.,
Taoyuan City 333, Taiwan (R.O.C.)

TEL : 886-(0)3-3591968
FAX : 886-(0)3-3591991

STATEMENT OF DEVIATION

NONE

DESCRIPTION:

Delta Electronics, Inc.
No.252, Shanying Rd., Guishan Dist.,
Taoyuan City 333, Taiwan (R.O.C.)

TEL : 886-(0)3-3591968
FAX : 886-(0)3-3591991

Specification For Approval

Customer : 0

Description : DC FAN

Customer P/N :

rev. :

Delta model no. : AFB0705MC-00F0R

Delta Safety Model No.: AFB0705MC-00

Sample revision. : 01

Issue no.:

Sample issue date : 9/6 2023

Quantity :

1. SCOPE:

THIS SPECIFICATION DEFINES THE ELECTRICAL AND MECHANICAL CHARACTERISTICS OF THE DC BRUSHLESS BLOWER FAN.

2. CHARACTERS:

ITEM	DESCRIPTION
RATED VOLTAGE	5V
OPERATION VOLTAGE	4.5 - 5.5 VDC
INPUT CURRENT(AVG.) # (MEAN CURRENT)	0.22 (MAX. 0.30) A SAFETY CURRENT ON LABEL : 0.50A
INPUT POWER(AVG.)	1.10 (MAX. 1.50) W
SPEED	2900 ± 10% R.P.M.
MAX. AIR FLOW (AT ZERO STATIC PRESSURE) (WITH FRAME 4102132600)	0.626 (MIN. 0.563) M ³ /MIN. 22.09 (MIN. 19.88) CFM
MAX. AIR PRESSURE (AT ZERO AIRFLOW) (WITH FRAME 4102132600)	2.36 (MIN. 1.91) mmH ₂ O 0.093 (MIN. 0.075) inchH ₂ O
ACOUSTICAL NOISE (AVG.) (FAN ONLY)	28.1 (MAX. 32.1) dB-A
INSULATION TYPE	UL: CLASS A
INSULATION STRENGTH	10 MEG OHM MIN. AT 500 VDC (BETWEEN FRAME AND (+) TERMINAL)
DIELECTRIC STRENGTH	5 mA MAX. AT 500 VAC 50/60 Hz ONE MINUTE, (BETWEEN FRAME AND (+) TERMINAL)

: THE MAX VALUE OF CONSUMING CURRENT DOES NOT REPRESENT THE PEAK VALUE, THE PEAK VALUE NEED MEASURE BY OSCILLOSCOPE.

PART NO:

DELTA MODEL: AFB0705MC-00F0R

LIFE EXPECTANCE (L10) (AT LABEL VOLTAGE)	70,000 HOURS CONTINUOUS OPERATION AT 40 °C WITH 15 ~ 65 %RH.
ROTATION	CLOCKWISE VIEW FROM NAME PLATE SIDE.
LOCK ROTOR SHUT DOWN	THE CURRENT WILL SHUT DOWN, WHEN ROTOR LOCKED AND FIXED.

NOTES:

1. ALL READINGS ARE MEASURED AFTER STABLY WARMING UP THROUGH 10 MINUTES.
2. STANDARD AIR PROPERTY IS AIR AT (Td) 25°C TEMPERATURE, (RH) 65% RELATIVE HUMIDITY , AND (Pb) 760 mmHg BAROMETRIC PRESSURE.
3. THE VALUES WRITTEN IN PARENS , (), ARE LIMITED SPEC.
4. ACOUSTICAL NOISE MEASURING CONDITION:

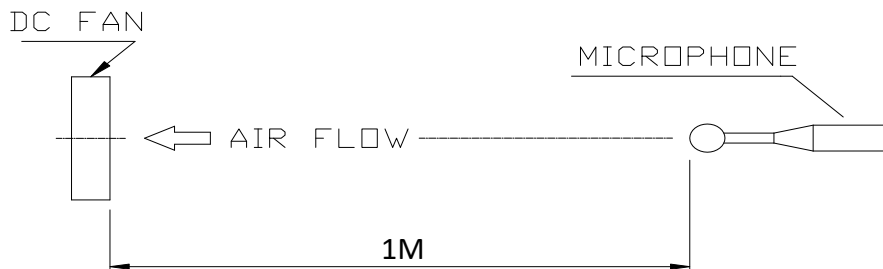

NOISE IS MEASURED AT RATED VOLTAGE IN FREE AIR IN ANECHOIC CHAMBER WITH B & K SOUND LEVEL METER WITH MICROPHONE AT A DISTANCE OF A METER FROM THE FAN INTAKE.

PART NO:

DELTA MODEL: AFB0705MC-00F0R

3. MECHANICAL:

- 3-1. DIMENSIONS----- SEE DIMENSIONS DRAWING
- 3-2. FRAME----- PLASTIC UL: 94V-0
- 3-3. IMPELLER----- PLASTIC UL: 94V-0
- 3-4. BEARING SYSTEM----- TWO BALL BEARING
- 3-5. WEIGHT----- 25 GRAMS(REF)

4. ENVIRONMENTAL:

- 4-1. OPERATING TEMPERATURE----- 0 TO +70 DEGREE C
- 4-2. STORAGE TEMPERATURE----- -10 TO +75 DEGREE C
- 4-3. OPERATING HUMIDITY----- 5 TO 90 % RH
- 4-4. STORAGE HUMIDITY----- 5 TO 95 % RH

5. PROTECTION:

- 5-1. LOCKED ROTOR PROTECTION
IMPEDANCE OF MOTOR WINDING PROTECTS MOTOR FROM FIRE IN
96 HOURS OF LOCKED ROTOR CONDITION AT THE RATED VOLTAGE.

6. RE OZONE DEPLETING SUBSTANCES:

- 6-1. NO CONTAINING PBBs, PBBOs, CFCs, PBBEs, PBDPEs AND HCFCs.

7. PRODUCTION LOCATION

- 7-1. PRODUCTS WILL BE PRODUCED IN CHINA OR THAILAND.

PART NO:

DELTA MODEL: AFB0705MC-00F0R

8. P & Q CURVE:

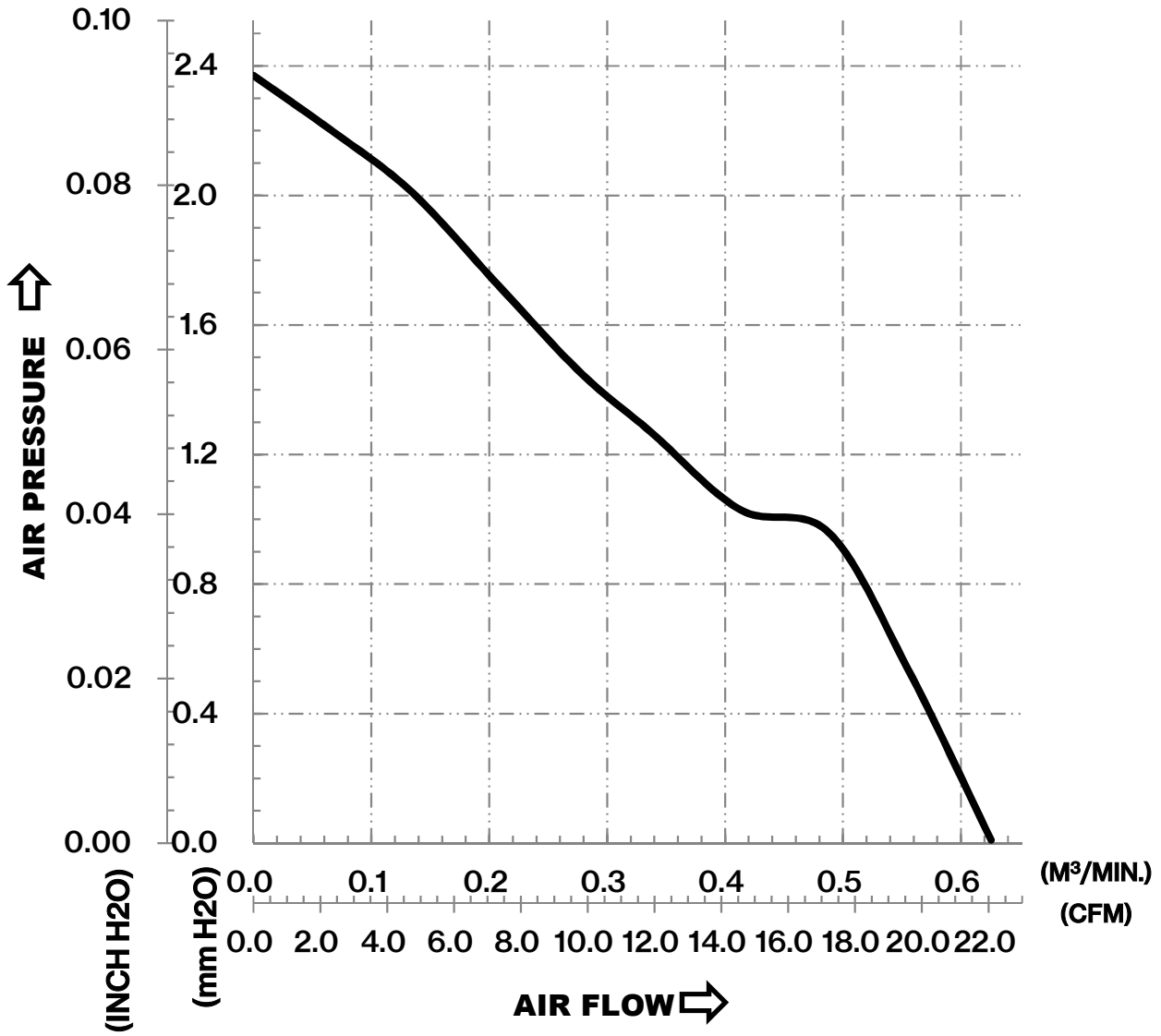

*TEST CONDITION: INPUT VOLTAGE-----OPERATION VOLTAGE
TEMPERATURE-----ROOM TEMPERATURE
HUMIDITY-----65%RH

PART NO:

DELTA MODEL: AFB0705MC-00F0R

9. DIMENSION DRAWING:

LABEL:



DRAWING:

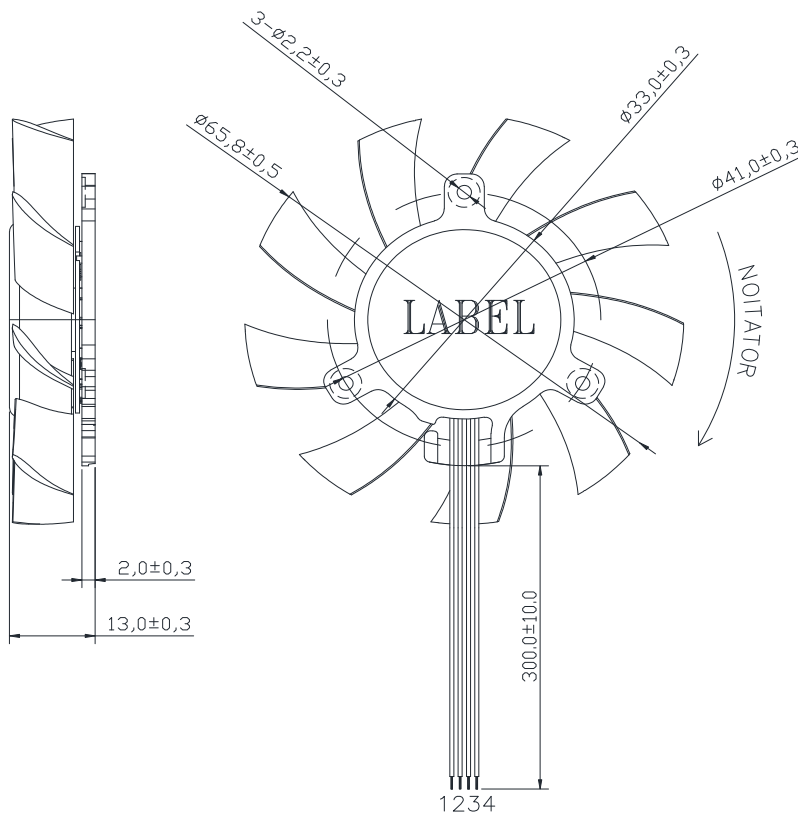

UNIT: mm

NOTES:

NOTES:

1. LEAD WIRE: UL10368 AWG#28

PIN 1: BLACK WIRE -----(-)

PIN 2: RED WIRE -----(+)

PIN 3: YELLOW WIRE -----(FG)

PIN 4: BLUE WIRE -----(PWM)

2. UNIT : mm

3. THIS PRODUCT IS RoHS COMPLIANT.

PART NO:

DELTA MODEL: AFB0705MC-00F0R

10.FREQUENCY GENERATOR (FG) SIGNAL:

10-1. OUTPUT CIRCUIT - OPEN COLLECTOR MODE:

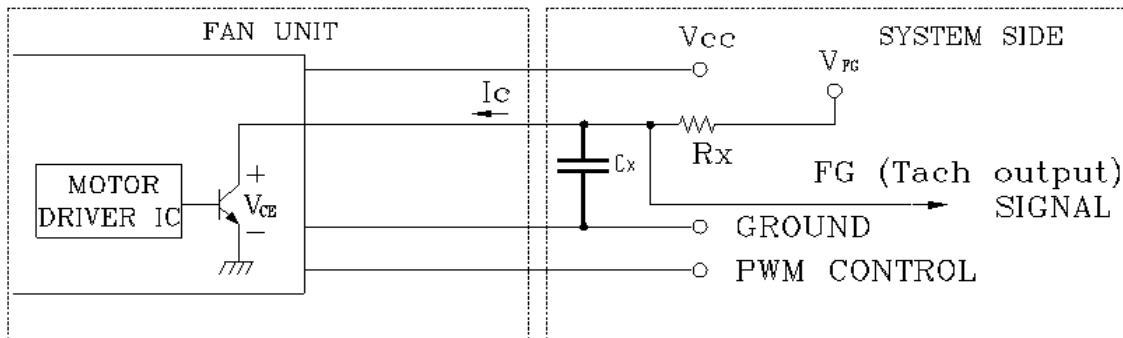

GENERAL CONDITION: VFG is 3.3V, Rx is 8.2Kohm, and Cx is 4nF.

CAUTION:

THE LEAD WIRE OF FG SIGNAL CAN NOT TOUCH
THE LEAD WIRE OF POSITIVE OR NEGATIVE.

10-2. SPECIFICATION:

VFG= 5.5V MAX.

Ic = 5mA MAX.

VCE= 0.5V MAX.

Rx ≥ VFG / Ic

10-3. FREQUENCY GENERATOR WAVEFORM:

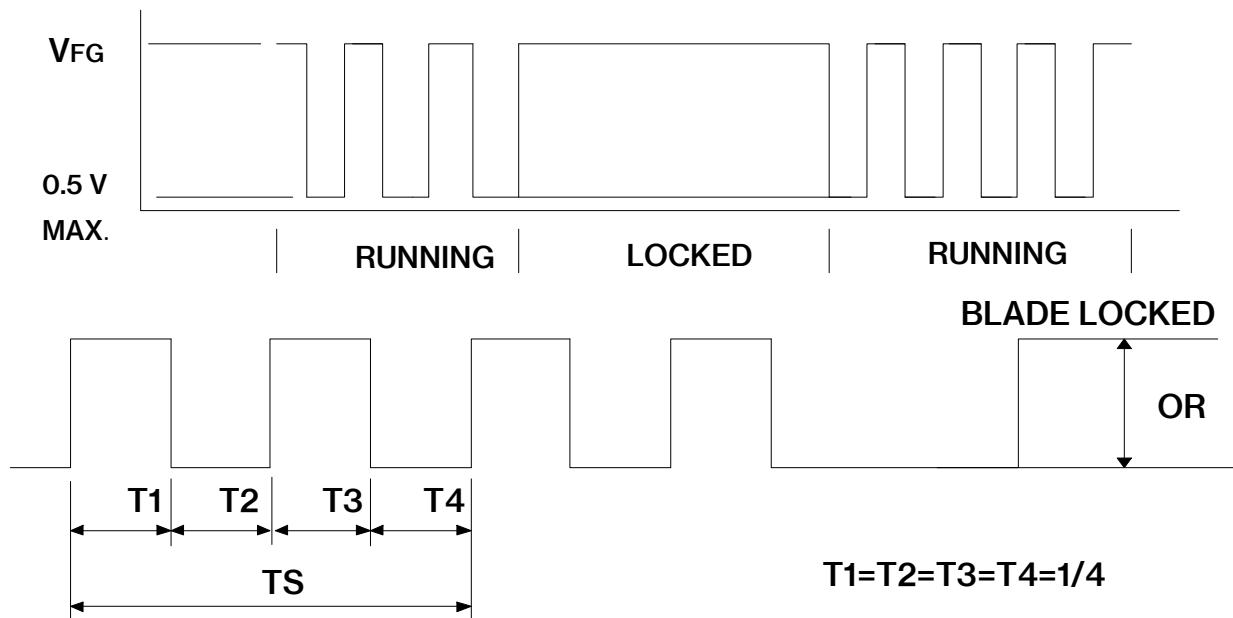

N=R.P.M

TS=60/N(SEC)

*VOLTAGE LEVEL AFTER BLADE LOCKED

*4 POLES

PART NO:

DELTA MODEL: AFB0705MC-00F0R

11.PWM CONTROL SIGNAL:
SIGNAL VOLTAGE RANGE: 0~5 VDC

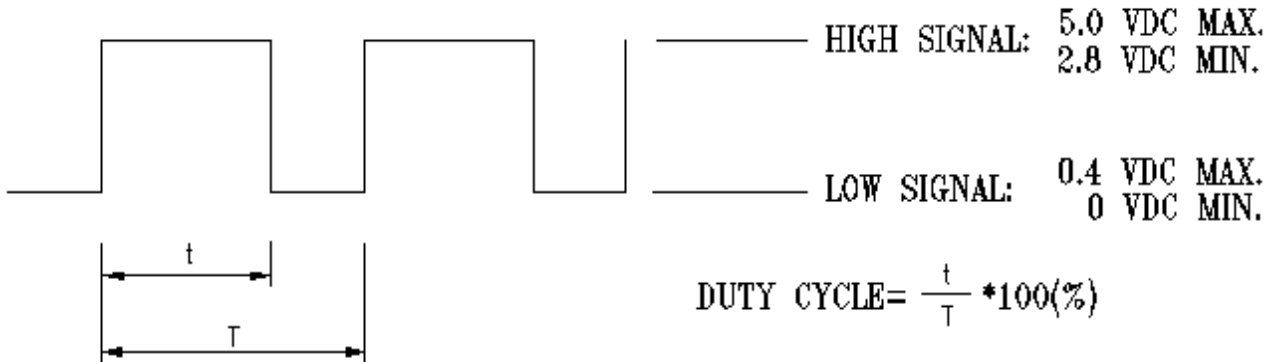

- *THE RECOMMENDED FREQUENCY OF PWM CONTROL SIGNAL IS 25K Hz.
- *AT 100% DUTY CYCLE, THE ROTOR WILL SPIN AT MAXIMUM SPEED.
- *AT 0% DUTY CYCLE, THE ROTOR WILL STOP.
- *WITH CONTROL SIGNAL LEAD DISCONNECTED, THE FAN WILL SPIN AT MAXIMUM SPEED.
- *AT 25K HZ, RATED VOLTAGE 5.0V, 20% DUTY CYCLE, 25 DEGREE C, THE FAN WILL BE ABLE TO START FROM A DEAD STOP.

12. FAN CHARACTERISTICS:

TEST CONDITION : AT 25°C, V = 5.0VDC & PWM SIGNAL AS FOLLOW

DUTY CYCLE (%)	SPEED R.P.M.	CURRENT(A) TYP
100	2900±10%	0.22 (MAX 0.30)
0	0	0.01 (MAX 0.02)

*PWM SIGNAL
PWM FREQUENCY = 25K HZ

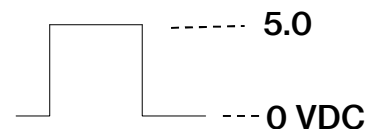

- *MIN. STARTED DUTY CYCLE : 20%, (AT 25 DEGREE C).
- WHEN DUTY CYCLE IS SET FOR MORE THAN 20%, (AT 25 DEGREE C), THE FAN WILL BE ABLE TO START FROM A DEAD STOP.



Application Notice

- 1. Delta will not guarantee the performance of the products if the application condition falls outside the parameters set forth in the specification.**
- 2. A written request should be submitted to Delta prior to approval if deviation from this specification is required.**
- 3. Please exercise caution when handling fans. Damage may be caused when pressure is applied to the impeller, if the fans are handled by the lead wires, or if the fan was hard-dropped to the production floor.**
- 4. Except as pertains to some special designs, there is no guarantee that the products will be free from any such safety problems or failures as caused by the introduction of powder, droplets of water or encroachment of insect into the hub.**
- 5. The above-mentioned conditions are representative of some unique examples and viewed as the first point of reference prior to all other information.**
- 6. It is very important to establish the correct polarity before connecting the fan to the power source. Positive (+) and Negative (-). Damage may be caused to the fans if connection is with reverse polarity, if there is no foolproof method to protect against such error specifically mentioned in this spec.**
- 7. Delta fans without special protection are not suitable where any corrosive fluids are introduced to their environment.**
- 8. Please ensure all fans are stored according to the storage temperature limits specified. Do not store fans in a high humidity environment. We highly recommend performance testing is conducted before shipping, if the fans have been stored over 6 months.**
- 9. Not all fans are provided with the Lock Rotor Protection feature. If you impair the rotation of the impeller for the fans that do not have this function, the performance of those fans will lead to failure.**
- 10. Please be cautious when mounting the fan. Incorrect mounting of fans may cause excess resonance, vibration and subsequent noise.**
- 11. It is important to consider safety when testing the fans. A suitable fan guard should be fitted to the fan to guard against any potential for personal injury.**
- 12. Except where specifically stated, all tests are carried out at room (ambient) temperature and relative humidity conditions of 25°C, 65% RH. The test value is only for fan performance itself.**
- 13. Be certain to connect an “ 4.7μF or greater” capacitor to the fan externally when the application calls for using multiple fans in parallel, to avoid any unstable power.**