

4G LTE Cellular Band Blade Antenna



AEACCA115021-S698



115.6 x 21.7 x 5.8 mm
RoHS/RoHS II Compliant

MSL = N/A: NOT APPLICABLE

FEATURES

- LTE700, GSM850, GSM900, DCS, PCS, UMTS1, LTE2600
- Gain of 2dBi
- VSWR \leq 2.0
- Low profile 5.8mm
- Adhesive mount

APPLICATIONS

- IoT applications
- M2M
- 4G/LTE applications
- GSM
- DCS
- PCS
- UMTS
- Remote technology/ monitoring
- POS terminals

EXTERNAL ANTENNA

Parameters	Min.	Typ.	Max.	Units	Note
Frequency Range		698~960/1710~2655		MHz	
VSWR			2.0		
Polarization Model	Linear				
Impedance		50		Ω	
Gain		2		dBi	(Zenith)
Operating Temperature	-40		+85	$^{\circ}$ C	
Input Power			10	W	

RETURN - LOSS CHARACTERISTICS

S11 Return-Loss

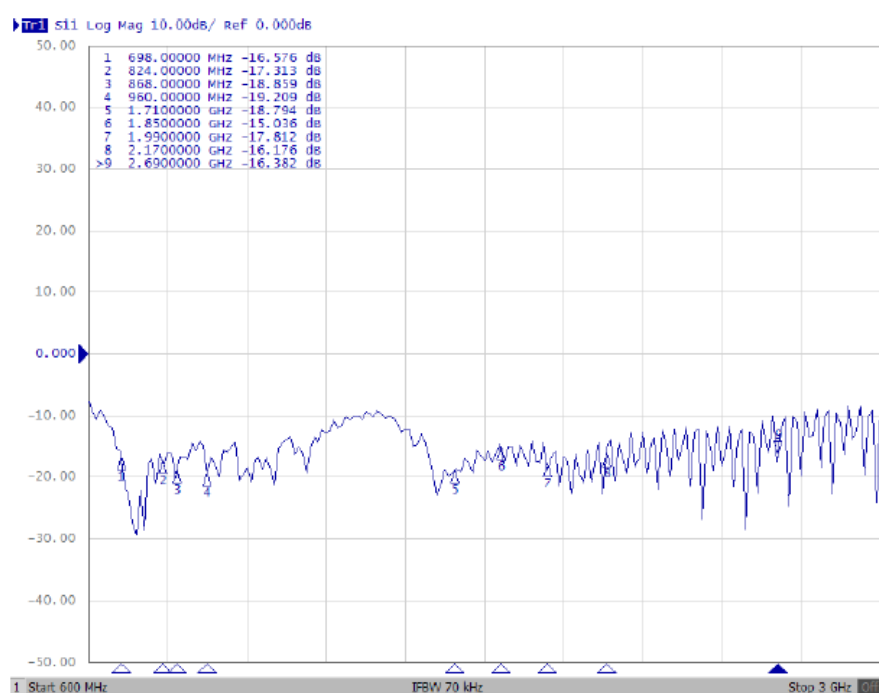

5101 Hidden Creek Ln Spicewood TX 78669
Phone: 512-371-6159 | Fax: 512-351-8858
For terms and conditions of sales, please visit:
www.abracon.com

REVISED: 04.10.2020

ABRACON IS
ISO9001-2015
CERTIFIED

4G LTE Cellular Band Blade Antenna



AEACCA115021-S698



115.6 x 21.7 x 5.8 mm
RoHS/RoHS II Compliant

MSL = N/A: NOT APPLICABLE

RADIATION PATTERNS

XY Plane

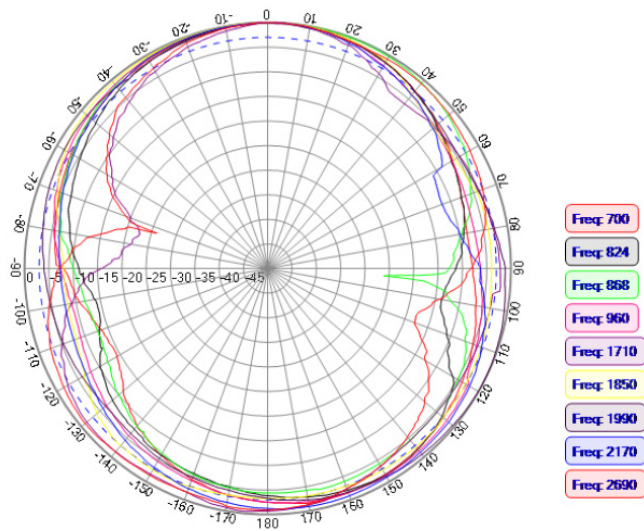

XZ Plane

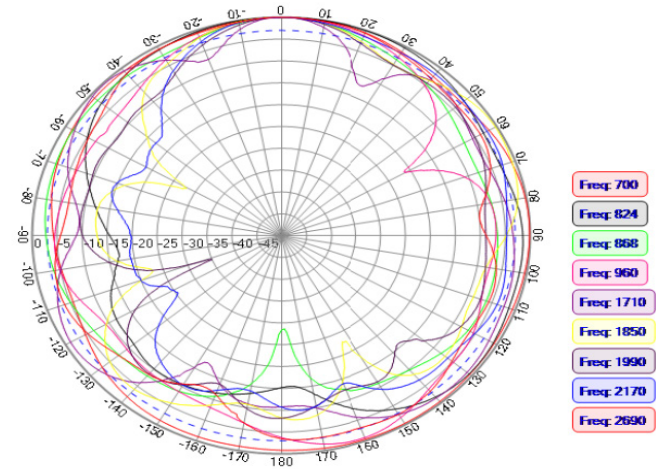

YZ Plane

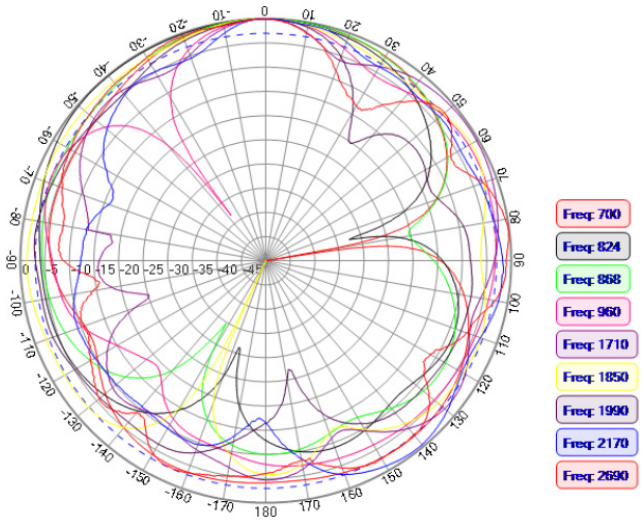

700 MHz

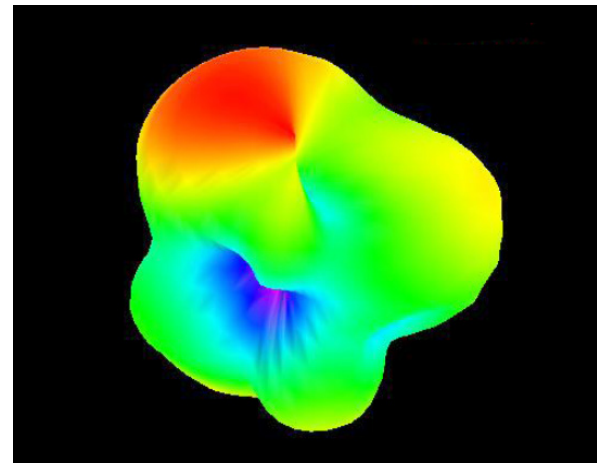

824 MHz

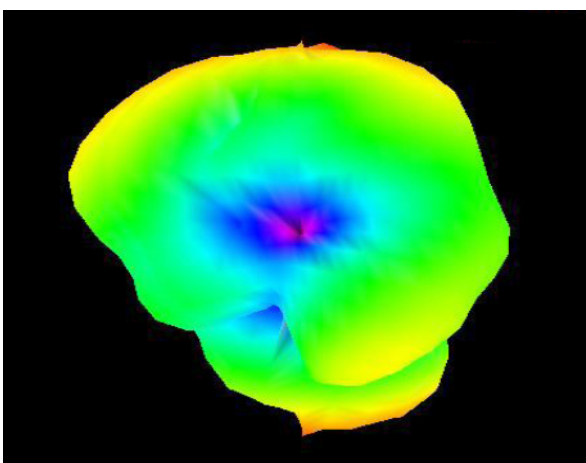

868 MHz

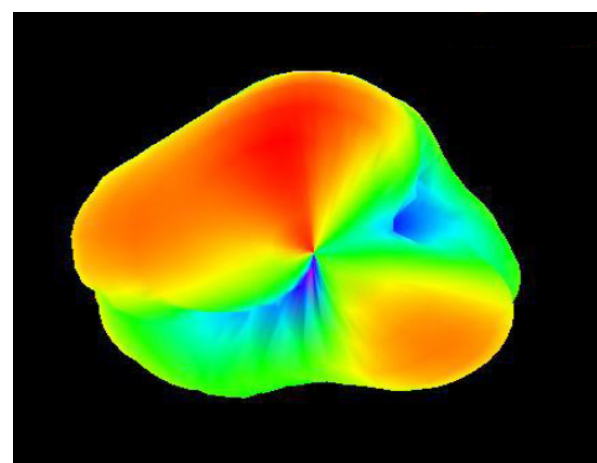

4G LTE Cellular Band Blade Antenna



AEACCA115021-S698



115.6 x 21.7 x 5.8 mm
RoHS/RoHS II Compliant

MSL = N/A: NOT APPLICABLE

3D PATTERNS

960 MHz

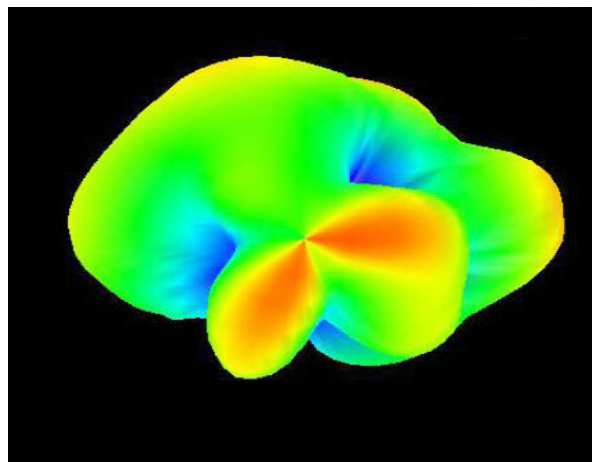

1710 MHz

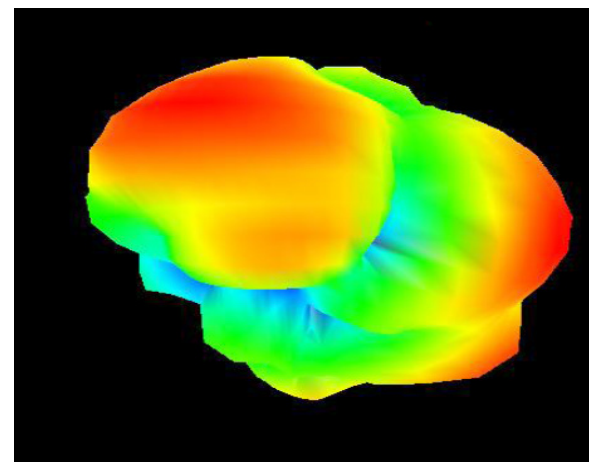

1850 MHz

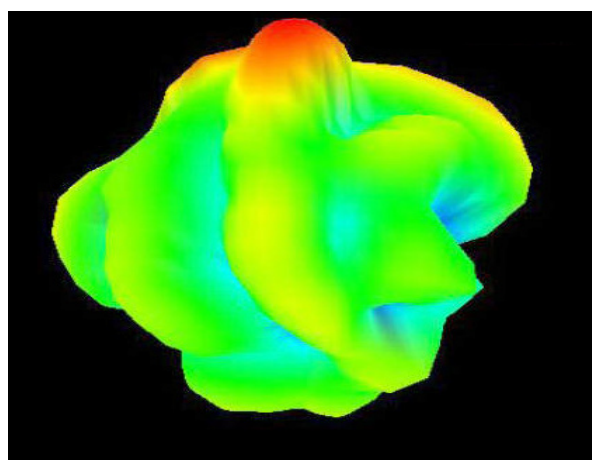

1990 MHz

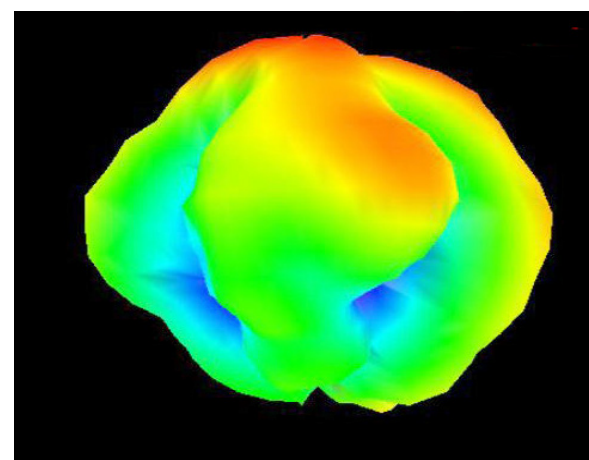

2170 MHz

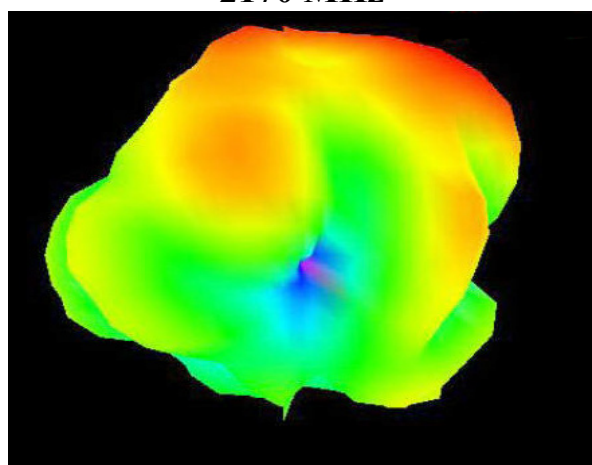

2690 MHz

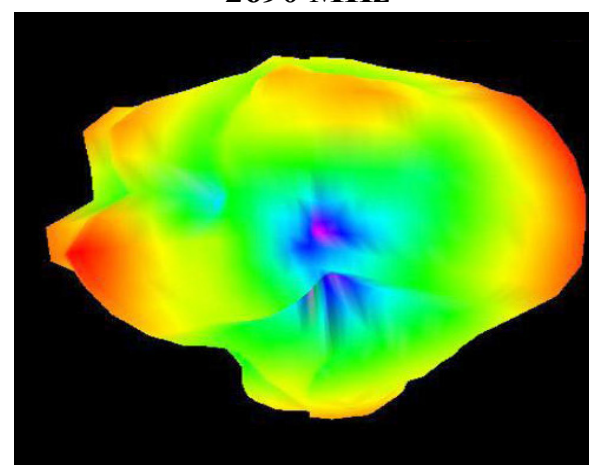

Frequency (MHz)	700	824	868	960	1710	1850	1990	2170	2690
Peak Gain (dBi)	2.12	0.83	2.60	1.00	1.61	0.78	0.34	-0.89	-3.00
Efficiency (%)	59	53	56	71	57	58	57	56	55

4G LTE Cellular Band Blade Antenna



AEACCA115021-S698



115.6 x 21.7 x 5.8 mm
RoHS/RoHS II Compliant

MSL = N/A: NOT APPLICABLE

DIMENSIONS

Unit: mm

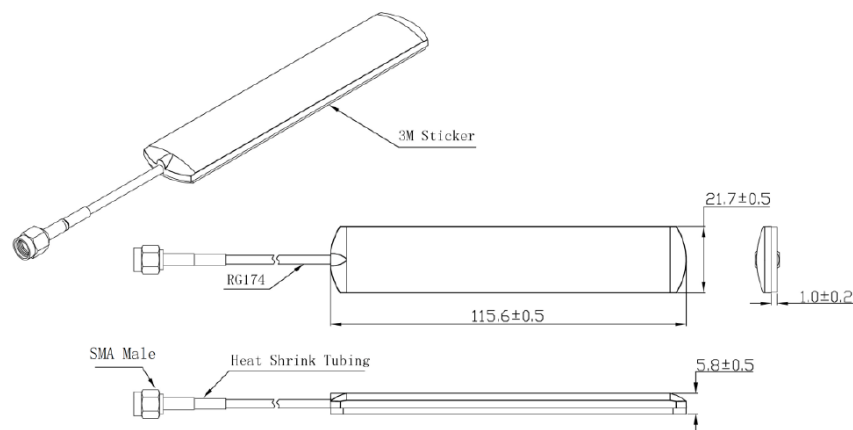

Parameters	Description
Cable Length	3.00 m
RF Cable	RG174
RF Connector	SMA
Radome Material	ABS
Mounting Type	Adhesive

PACKAGING

Each 700 x 320 x 155 mm size carton includes 250 pcs antenna, 13kgs/carton.

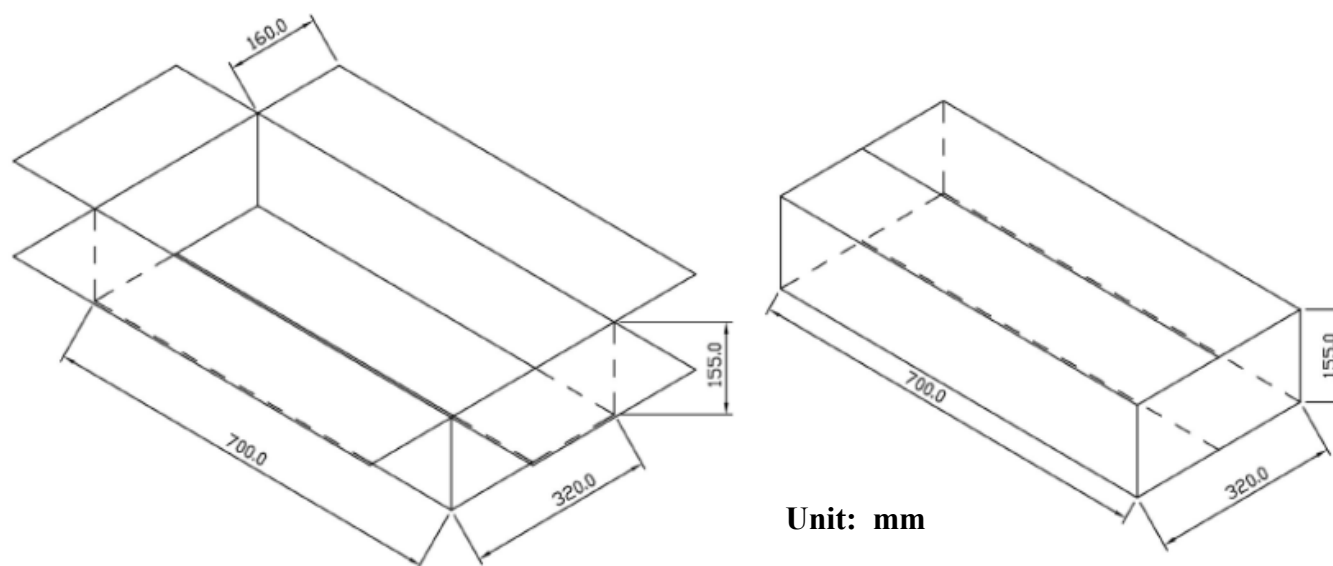

Unit: mm



5101 Hidden Creek Ln Spicewood TX 78669
Phone: 512-371-6159 | Fax: 512-351-8858
For terms and conditions of sales, please visit:
www.abracon.com

REVISED: 04.10.2020

ABRACON IS
ISO9001-2015
CERTIFIED