



AEACBA050018-SG4L2L5



50.0 x 50.0 x 18.0 mm
RoHS/RoHS II Compliant
MSL = 1

Features

- 1561.098 - 1602 MHz for GPS L1/GLONASS-G1/BEIDOU-B1
- 1176 -1227 MHz for GPS L5&L2/Galileo E5a&E5b/BEIDOU-B2
- Multiband GNSS with high positioning accuracy
- IP67 Rated
- Gain of 3.0 dBic
- Active GNSS with integrated LNA
- High LNA gain of 28 dB
- Low VSWR of 1.5
- RHCP polarization
- Improved GNSS reliability

Applications

- GPS L1, L2, L5, GLONASS, GALILEO and BEIDOU applications
- IoT
- M2M
- Remote technology monitoring
- Geofencing
- Navigation
- Surveying and mapping systems
- Logistics
- Precision transportation
- UAVs and Robotics
- Marine
- Autonomous Vehicles
- Agriculture

Electrical Specifications

Parameters	Min.	Typ.	Max.	Units	Notes
Antenna					
Operating Frequency Range		1561.098 ~ 1602		MHz	BDS-B1/GPS L1/ GLONASS-G1
		1176 ~ 1227			GPS-L5&L2/ Galileo-E5a&E5b/BDS-B2
VSWR			1.5		
Gain		3		dBic	@ PCB Zenith
Impedance		50		Ω	
Polarization		RHCP			
LNA					
Gain		28 ± 2		dB	
Noise Figure			1.0	dB	
VSWR			2		
Supply Voltage	3		5	V	DC
Current Consumption			45	mA	

Mechanical Specification

Parameters	Description
Cable Type	RG-174
Cable Length	3M
Connector	SMA Male
Radome Material	ABS
Mounting Method	Magnet + 3M adhesive



AEACBA050018-SG4L2L5



50.0 x 50.0 x 18.0 mm
RoHS/RoHS II Compliant
MSL = 1

Environmental Specification

Parameters	Description
Operating Temperature	-40°C to +85°C
Relative Humidity	Up to 95 %
Ingress Protection	IP67
Vibration	10 ~ 55 Hz with 1.5 mm amplitude 2 hours

Product Dimension

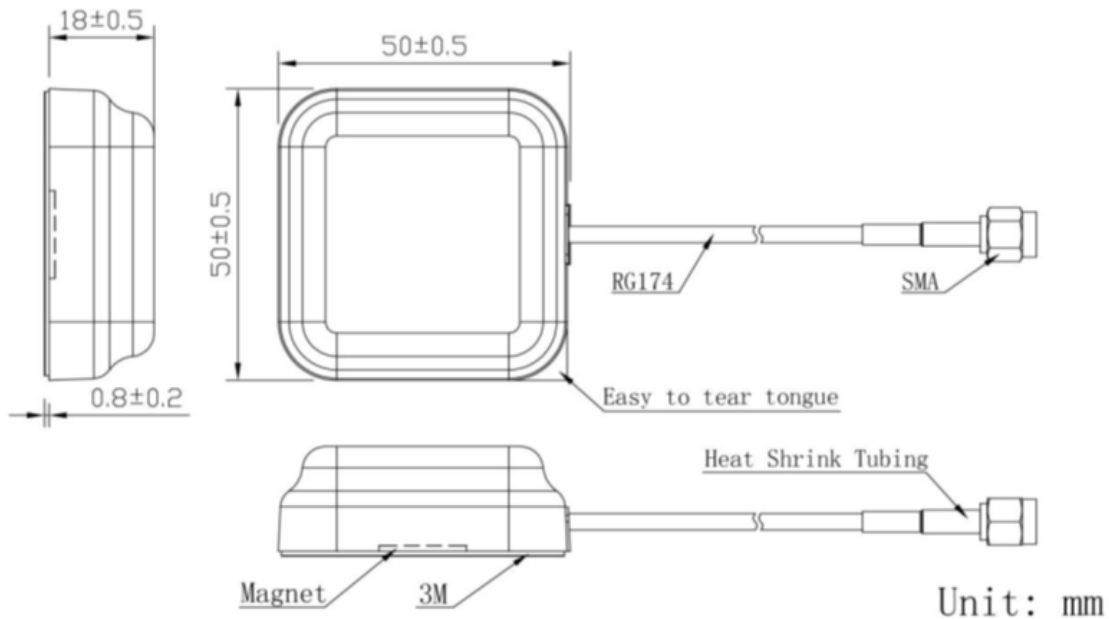



AEACBA050018-SG4L2L5



50.0 x 50.0 x 18.0 mm
RoHS/RoHS II Compliant
MSL = 1

VSWR

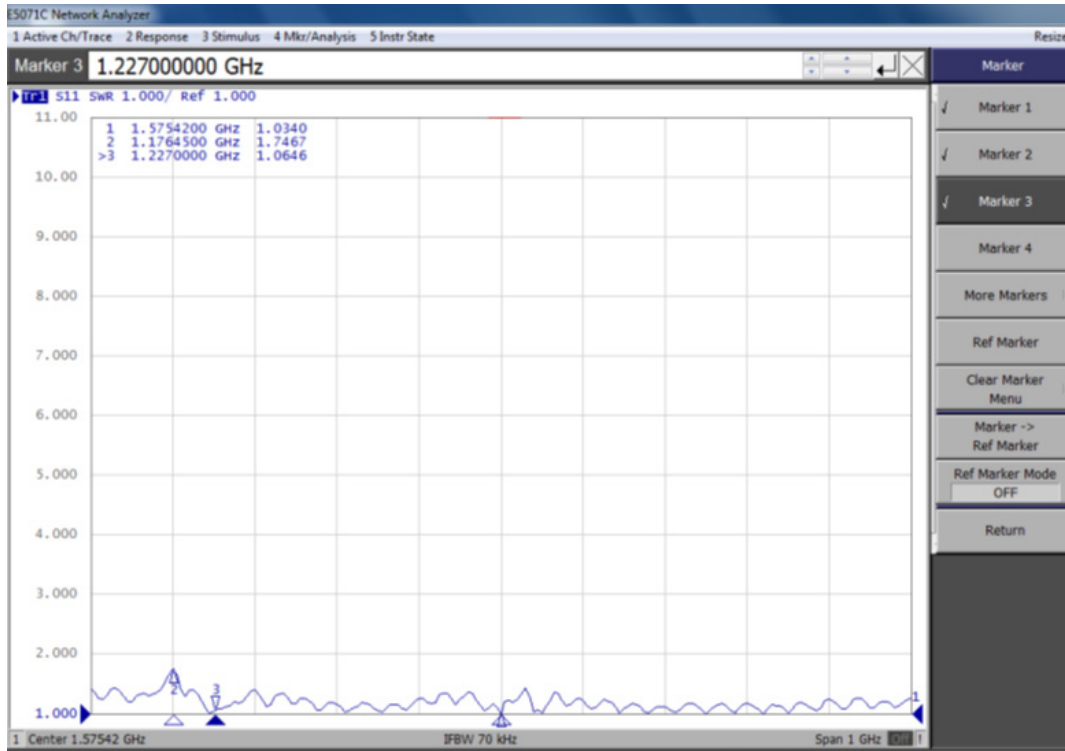



AEACBA050018-SG4L2L5



50.0 x 50.0 x 18.0 mm
RoHS/RoHS II Compliant
MSL = 1

Radiation Pattern

2D Pattern

XY PLANE

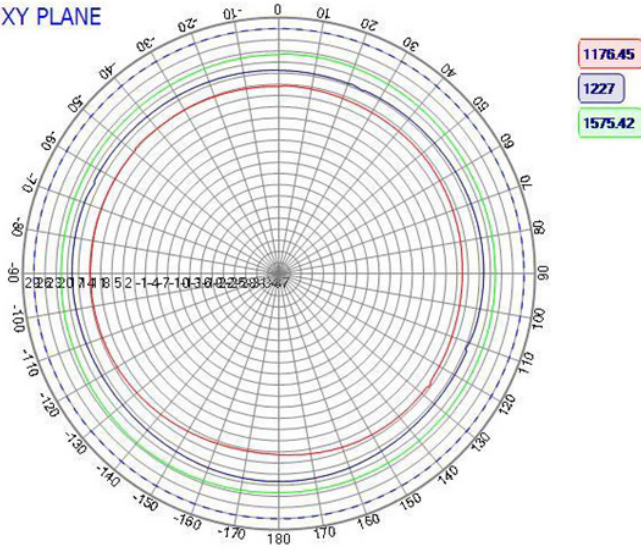

XZ PLANE

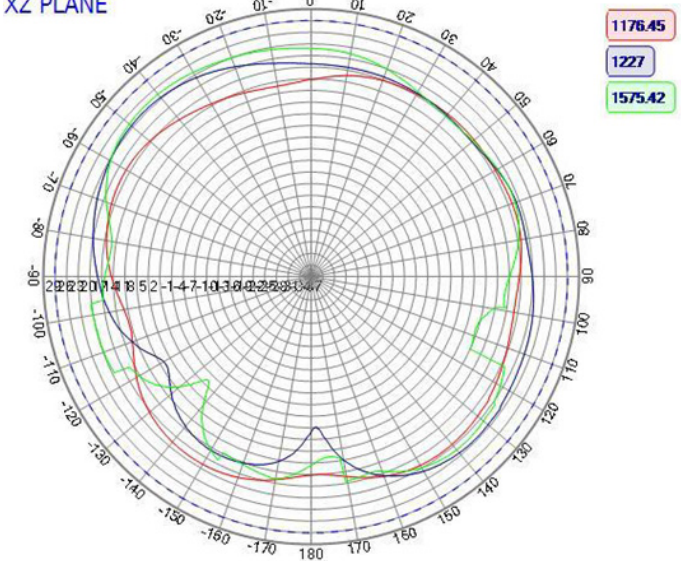

YZ PLANE

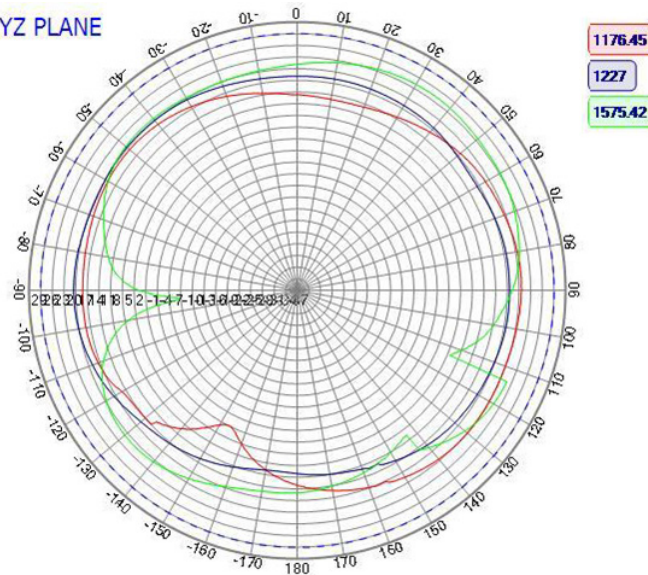



AEACBA050018-SG4L2L5



50.0 x 50.0 x 18.0 mm
RoHS/RoHS II Compliant
MSL = 1

Radiation Pattern

3D Pattern

1575 MHz

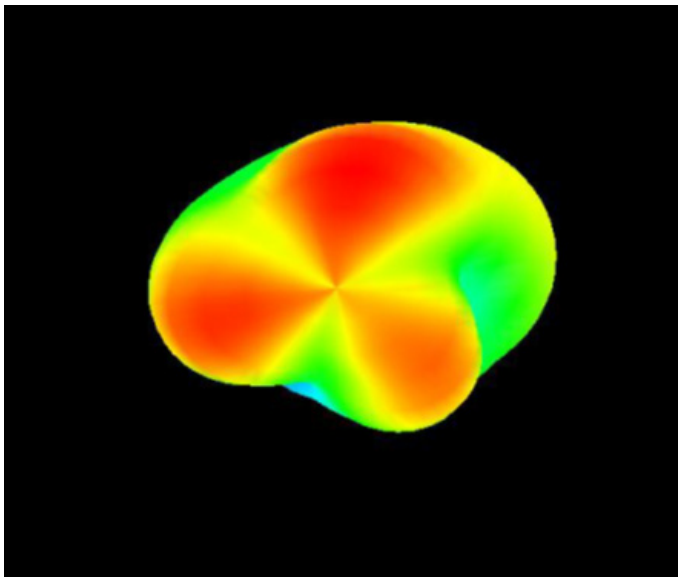

1176 MHz

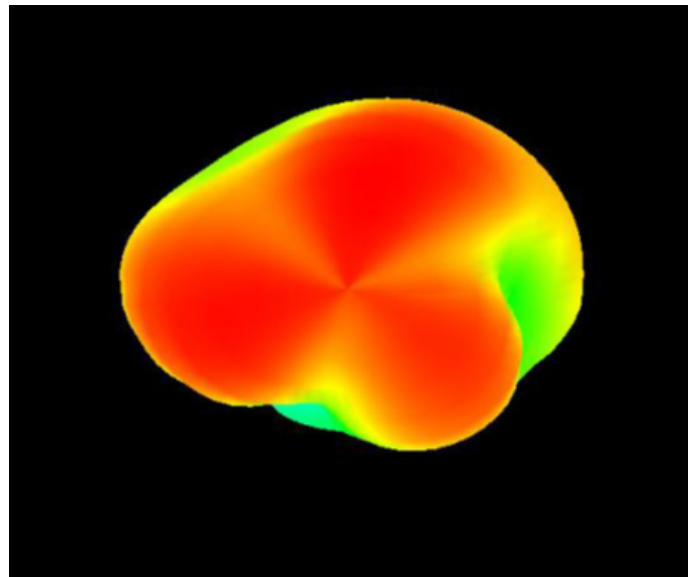

1227 MHz

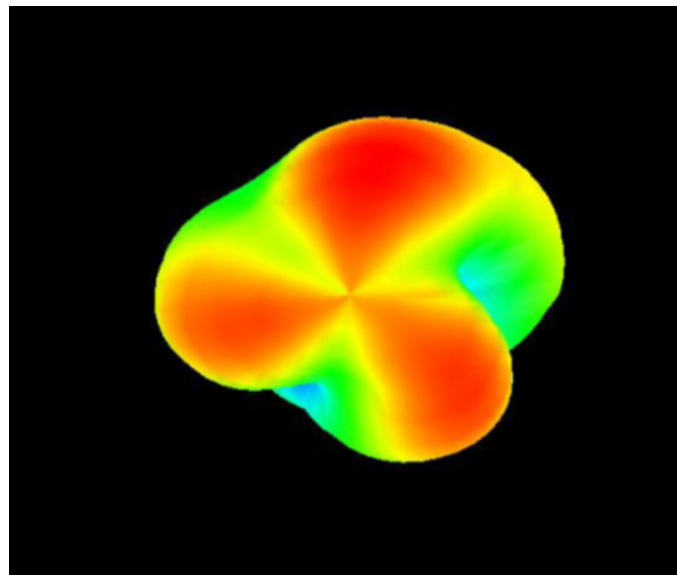

External Active GPS L1+L2+L5/GLONASS/GALILEO/BEIDOU Antenna



AEACBA050018-SG4L2L5



50.0 x 50.0 x 18.0 mm
RoHS/RoHS II Compliant
MSL = 1

Packaging

A carton holds 100 pcs of antenna. Each carton is 70 x 32 x 16 cm and weighs 16 kg.

ATTENTION: Abracon LLC's products are COTS – Commercial-Off-The-Shelf products; suitable for Commercial, Industrial and, where designated, Automotive Applications. Abracon's products are not specifically designed for Military, Aviation, Aerospace, Life-dependent Medical applications or any application requiring high reliability where component failure could result in loss of life and/or property. For applications requiring high reliability and/or presenting an extreme operating environment, written consent and authorization from Abracon LLC is required. Please contact Abracon LLC for more information.



5101 Hidden Creek Ln Spicewood TX 78669
Phone: 512-371-6159 | Fax: 512-351-8858
For terms and conditions of sales, please visit:
www.abracon.com

REVISED: 11-6-19

ABRACON IS
ISO9001-2015
CERTIFIED